

2024
2025



MEASURING INSTRUMENTS

CATALOGUE NO. 207



M&B Calibr

QUALITY | INNOVATION | SERVICE | VALUE



The products with this mark are **INSIZE PLUS** brand, otherwise the products are **INSIZE** brand.

INSIZE is our standard quality

INSIZE PLUS is our premium quality



The products with this mark are supplied with manufacturer inspection certificate.

Measuring Length		Permissible Error	Error		Measuring Length		Permissible Error	Error	
			External	Internal				External	Internal
0.4 DIA		+0.0005 -0.0010	/	0.0005	Φ10		+0.01 -0.02	/	0.01
2		±0.0010	-0.0005	/	50		±0.02	-0.01	/
4			-0.0005	/	100			-0.01	/
6			-0.0010	/	150			-0.02	/
8			/	/	200			/	/
10		±0.0015	/	/	250		±0.03	/	/
12			/	/	300			/	/



Please scan QR code to watch the videos of products.

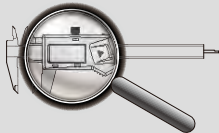

How to search:

1. Search for products according to category in PRODUCT INDEX (next 6 pages)
2. Search for products in CODE NO. INDEX (page 823-828)
3. Search for products in APPLICATION INDEX OF MEASURING TOOLS (page 829-835)

We reserve the right to change or modify the design and specification of products in this catalogue without prior notice.

Copyright © INSIZE CO., LTD. All Rights Reserved.
INSIZE is the registered trademark of INSIZE CO., LTD.



PRODUCT INDEX

1 DATA OUTPUT AND SOFTWARE PAGE 1-17

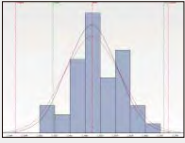

DATA MANAGEMENT SOFTWARES



DATA OUTPUT CABLES

3 DEPTH MEASUREMENT PAGE 65-79



DEPTH GAGES



DEPTH GAGES



DEPTH MICROMETERS

2 CALIPERS PAGE 18-64



CALIPERS

4 HEIGHT MEASUREMENT PAGE 80-88



DIGITAL HEIGHT GAGES



HEIGHT GAGES

5 COMPARISON INSTRUMENTS PAGE 89-93



CARBON FIBER COMPARISON GAGES



INTERNAL AND EXTERNAL DIAMETER COMPARISON INSTRUMENTS



OUTSIDE DIAMETER MEASURING STANDS

6 MICROMETERS PAGE 94-156



HIGH PRECISION DIGITAL MICROMETERS/SNAP GAGES



OUTSIDE MICROMETERS



3-WIRES

7 BORE DIAMETER, CIRCUMFERENCE MEASUREMENT PAGE 157-184



INSIDE MICROMETERS



INSIDE MICROMETERS



THREE POINTS INTERNAL MICROMETERS

8 ARC RADIUS MEASUREMENT PAGE 185-192



LARGE DIAMETER GAGES



OUTSIDE DIAMETER VARIATION MEASURING INSTRUMENTS



OUTSIDE DIAMETER MEASURING INSTRUMENTS



BORE PLUG GAGES



BORE GAGES



TELESCOPING GAGE SETS



CIRCUMFERENCE TAPES



DIGITAL RADIUS GAGES



DIGITAL ARC RADIUS CALIPERS



DIGITAL RADIUS CALIPERS

PRODUCT INDEX

9 CHAMFER MEASUREMENT PAGE 193-195



DIGITAL CHAMFER GAGES



DIGITAL CHAMFER GAGES

10 INDICATORS, LINEAR GAGES, DIAL INDICATOR STANDS PAGE 196-246



DIAL TEST INDICATORS



INDICATORS



LINEAR GAGES AND DISPLAY UNITS



MAGNETIC STANDS



DIAL INDICATOR STANDS (NON-MAGNETIC)



DIAL INDICATOR STANDS

11 INDICATING MEASURING INSTRUMENTS PAGE 247-267



INTERNAL CALIPER GAGES



EXTERNAL CALIPER GAGES



THICKNESS GAGES



RUBBER THICKNESS GAGES



TUBE THICKNESS GAGES



SNAP GAGES



STEP AND GAP GAGES



MINI DIGITAL HEIGHT GAGES



HEIGHT GAGES



CRANKSHAFT TESTERS



KEYWAY GAGES

12 PETROLEUM PIPE THREAD MEASUREMENT PAGE 268-282



THREAD PITCH MEASURING INSTRUMENTS



THREAD TAPER MEASURING INSTRUMENTS



THREAD HEIGHT MEASURING INSTRUMENTS



THREAD CREST DIAMETER MEASURING INSTRUMENTS



GROOVE DIAMETER MEASURING INSTRUMENTS



GROOVE WIDTH MEASURING INSTRUMENTS



THREAD GAGES FOR PETROLEUM EQUIPMENT

13 STANDARDS AND GAGE BLOCKS PAGE 283-333



GAGE BLOCKS



CMM CHECK MASTERS



ANGLE GAGE BLOCKS



TAPER GAGES



PIN GAGES



CYLINDER GAGES



ADJUSTABLE SNAP GAGES



SETTING RINGS



PLAIN PLUG GAGES



MEASURING BALLS



THREADED HOLE LOCATION GAGES



THREAD DEPTH GAGES



THREAD RING GAGES



THREAD PLUG GAGES

PRODUCT INDEX

14 ANGLE, STRAIGHTNESS, FLATNESS MEASUREMENT PAGE 334-351



ANGLE METERS



PROTRACTORS



GRANITE SQUARES



PERPENDICULARITY TESTERS



SQUARES



STRAIGHT EDGES



STRAIGHT EDGES



STRAIGHTNESS/FLATNESS GAGES



OPTICAL FLATS

17 SET-UP TOOLS PAGE 400-425



GRANITE SURFACE PLATES



V-BLOCKS



PERMANENT MAGNETIC CHUCKS



PARALLELS



PARALLEL/SQUARE SETS



ANGLE PLATE SETS



ADJUSTABLE ANGLE BLOCKS



RIGHT ANGLE PLATES



SINE BARS



PRECISION VISES



STAGES

15 CONCENTRICITY AND RUNOUT TESTERS PAGE 352-360



CONCENTRICITY GAGES



BENCH CENTERS



SHANK RUNOUT TESTERS

16 SIMPLE MEASURING TOOLS PAGE 361-399



FEELER GAGES



PITCH GAGES



RADIUS GAGES



TAPER SLOT GAGES



TAPER BORE GAGES



WELDING GAGES



INSIDE/OUTSIDE CALIPERS



MEASURING TAPES



MEASURING WHEELS



STEEL RULES



COMBINATION SQUARES



T-BEVELS



SCRIBING CALIPERS



PRECISION SCREWDRIVER SETS



LED FLASHLIGHTS



MEASURING TOOL SETS

PRODUCT INDEX

18 ON-MACHINE MEASUREMENT

PAGE 426-439



INFRARED TRANSMISSION PROBES FOR CNC MACHINE TOOLS



VIDEO MEASURING INSTRUMENT FOR MACHINE TOOLS



TRIGGER-TYPE 3D PROBES



CENTERING INDICATORS



EDGE FINDERS



EDGE FINDERS FOR EDM



ZERO SETTERS WITH CABLE



ZERO SETTERS



ZERO SETTERS

21 FLAW DETECTORS

PAGE 469-473



DIGITAL ULTRASONIC FLAW DETECTORS



PORTABLE MAGNETIC POWDER FLAW DETECTORS



RECHARGEABLE UV FLAW DETECTION LIGHTS



PENETRATION STANDARD TEST BLOCKS

22 CMM

PAGE 474-490



CMM



MEASURING ARMS



STYLI FOR CMM



GAGE BLOCK STANDS FOR CMM



CERAMIC BALL GAGES

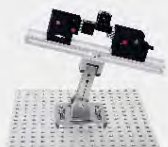

JIG SETS FOR CMM

19 LEVELS

PAGE 440-453



LEVELS



CROSS-LINE LASER LEVELS



SELF-LEVELING ROTARY LASERS

20

PAGE 454-468



LINEAR SCALES



SCALES



AIR GAGES AND DISPLAYS



LASER SCAN MICROMETERS



SPECTROMETERS

23 TOOL PRESETTERS, PROFILE PROJECTORS, QUICK MEASUREMENT SYSTEMS, VISION MEASURING SYSTEMS



TOOL PRESETTERS



PROFILE PROJECTORS



QUICK MEASUREMENT SYSTEMS



VISION MEASURING SYSTEMS

25 VIDEOSCOPIES

PAGE 596-612



VIDEOSCOPIES



RIGID BORESCOPIES

PRODUCT INDEX

24 MICROSCOPES, MAGNIFIERS PAGE 525-595



TOOLMAKER MICROSCOPES

DIGITAL MICROSCOPES

MICROSCOPES



MAGNIFIERS



TELESCOPING INSPECTION MIRRORS

26 COATING INSPECTION PAGE 613-628



COATING THICKNESS GAGES



SURFACE PROFILE GAGES



WET FILM GAGES



GLOSS METERS



COLORIMETERS



PENCIL HARDNESS TESTERS



CROSS CUT ADHESION TESTERS



DIGITAL ADHESION TESTERS



ROTATIONAL ABRASION TESTERS



PAINT FILM FLEXIBILITY TESTERS



IMPACT TESTERS

27 PORTABLE INSTRUMENTS PAGE 629-659



ULTRASONIC THICKNESS GAGES



TACHOMETERS



STROBOSCOPES



VIBRATION PENS



DIGITAL MULTIMETERS



DIGITAL AC/DC CLAMP METERS



VOLTAGE TESTERS



PORTABLE CONDUCTIVITY/TDS METERS



PORTABLE pH METERS



LASER DISTANCE METERS



REFRACTOMETERS



DIGITAL STOPWATCHES



STROKE COUNTERS



DIGITAL MOISTURE METERS



DIFFERENTIAL PRESSURE MANOMETERS



ANEMOMETERS



BOURDON TUBE PRESSURE GAGES



SOUND LEVEL METERS



LIGHT METERS



GAS DETECTORS



TESLAMETERS



LASER BELT TENSION METERS

PRODUCT INDEX

28 TEMPERATURE AND HUMIDITY MEASUREMENT PAGE 660-668



INFRARED THERMAL IMAGING CAMERAS



INFRARED THERMOMETERS



THERMOHYGROMETERS



THERMOHYGROMETERS

32 TESTING MACHINES, FORCE GAGES PAGE 765-777



UNIVERSAL TESTING MACHINES

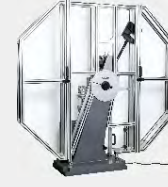

IMPACT TESTING MACHINES



DIGITAL SPRING TESTERS



FORCE GAGES



DIAL TENSION GAGES

29 ROUNDNESS, PROFILE AND ROUGHNESS TESTERS PAGE 669-695



ROUNDNESS MEASURING MACHINES



PRECISION AIR FLOATING ROTARY TABLES



SURFACE PROFILE MEASURING MACHINES



ROUGHNESS TESTERS



SURFACE ROUGHNESS SPECIMENS

33 TORQUE TESTERS TORQUE WRENCHES PAGE 778-801



TORQUE TESTERS



TORQUE SCREWDRIVERS



TORQUE WRENCHES



TORQUE ADAPTERS



TORQUE MULTIPLIERS

30 HARDNESS TESTERS PAGE 696-749



HARDNESS TESTERS



CONCRETE STRENGTH TESTERS

34 SCALES PAGE 802-818



SCALES



WEIGHTS

31 METALLOGRAPHY PREPARATION PAGE 750-764



CUTTING MACHINES



GRINDERS AND POLISHERS



MOUNTING PRESSES

35 SALT SPRAY TESTERS, TEMPERATURE AND HUMIDITY TESTERS PAGE 819-822



SALT SPRAY TESTERS



TEMPERATURE AND HUMIDITY TESTERS

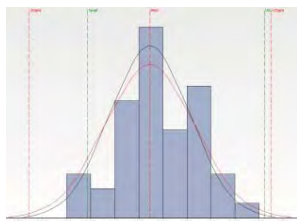

Data Management Softwares
Page 2-3



Wireless Data Transmission Systems
Page 4-7



Data Output Cables
Page 8-17

MEASUREMENT DATA MANAGEMENT AND ANALYSIS SOFTWARE CODE 7317

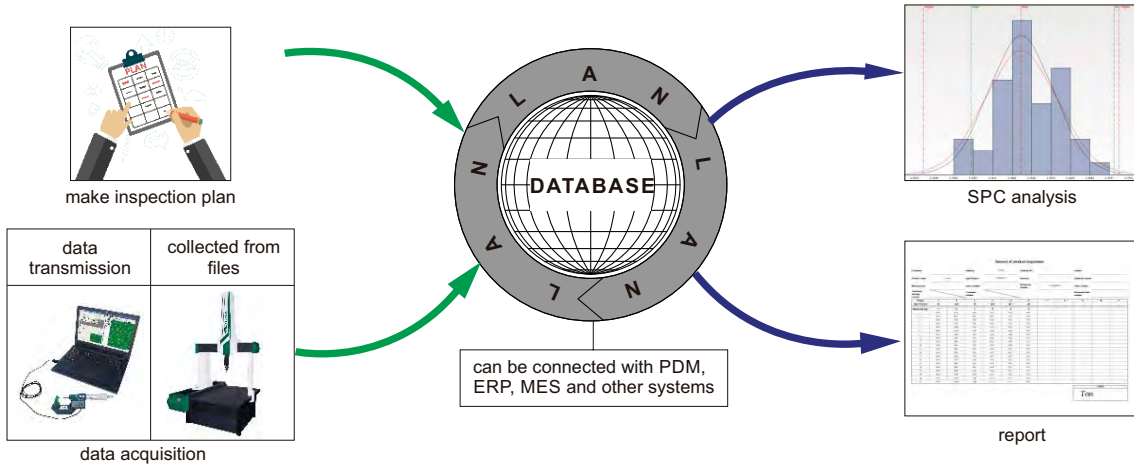

Make inspection plan

- Define the dimensions, tolerances, control range and other parameters of workpieces

define the drawing of workpieces

define association items of data

define the measured dimension and tolerance

Seq	Data Member Code	Data Member Name	Measuring Tool	1	2	3	4	5	6
1	DC04070001	Check type		2022-06-08 11:16:27	2022-06-08 11:16:27	2022-06-08 11:16:27	2022-06-08 11:16:27	2022-06-08 11:16:27	2022-06-08 11:16:27
2	DC04070002	Serial number							
3	DC04070003	Furnace No.							
4	DC02070001	Flatness:0.008	CMM						
5	DC02070002	2.39+0.01/-0.03	Vernier caliper						
6	DC02070003	Verticality:0.008	CMM						
7	DC02070004	2.335±0.004	Vernier caliper						
8	DC02070005	Outside diameter=45±0.002	Micrometer						
9	DC02070006	Inner diameter=45±0.002	Micrometer						
10	DC02070007	Wall thickness							

Data acquisition

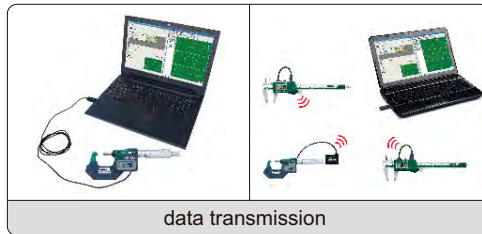
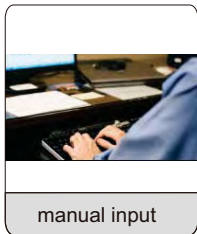

Seq	Data Member Code	Data Member Name	Measuring Tool	1	2	3	4	5
1	DC04070001	Check type		2022-06-08 10:58:07	2022-06-08 10:58:07	2022-06-08 10:58:08	2022-06-08 11:03:40	2022-06-08 11:19:08
2	DC04070002	Serial number		2022060801	2022060801	2022060801	2022060802	2022060802
3	DC04070003	Furnace No.		F00120	F00120	F00120	F00120	F00120
4	DC02070001	Flatness:0.008	CMM	0.0080	0.0080	0.0080	0.0082	2.440
5	DC02070002	2.39+0.01/-0.03	Vernier caliper	2.391	2.391	2.391	2.410	
6	DC02070003	Verticality:0.008	CMM	0.0080	0.0080	0.0080	0.0080	
7	DC02070004	2.335±0.004	Vernier caliper	2.330	2.330	2.330	2.330	
8	DC02070005	Outside diameter=45±0.002	Micrometer	45.0020	45.0020	45.0020	45.0020	
9	DC02070006	Inner diameter=45±0.002	Micrometer	45.0010	45.0010	45.0010	45.0010	
10	DC02070007	Wall thickness		0.0010	0.0020	0.0010	-0.0033	

measurement interface

To be continued

Continued from previous page

SPC

- Provide variety of quality analysis control charts



Report

The figure illustrates the report generation process:

- report template:** A Microsoft Excel spreadsheet with a form for inspection data.
- generate report:** A completed report titled "Record of product inspection" with a table of inspection results.

The final report includes a signature field with the name "Tom" and a note: "support exporting electronic signature".

Management of inspection plan

The figure shows three different ways to manage an inspection plan:

- management by customers:** A table listing items with columns for Seq, Manag., List Item Code, List Item Name, Creation User, and Creation Time.
- management by drawings:** A tree structure under "INSIZE.COM" showing a hierarchy of drawings (A0103, A0104, B2467) and their associated workpiece numbers.
- management by departments:** A tree structure under "INSIZE.CN" showing a hierarchy of production areas (Production area 1, 2, 3) and their associated workpieces (Workpiece C, D).

1 WIRELESS DATA TRANSMISSION SYSTEM

- Through wireless transmission, the measurement data can be transmitted to computers or mobile phones
- Wireless zigbee protocol, conforming to IEEE802, 2.4GHz band
- Transmission distance is 15 meter (under the condition of no obstruction and no electromagnetic interference)





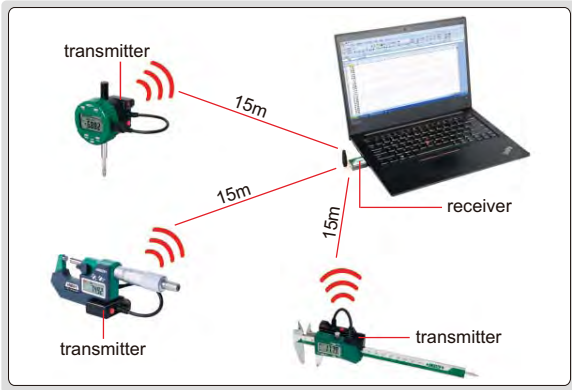

Transmitter

- Connecting to digital measuring tools such as calipers, micrometers and indicators
- CR2032 battery

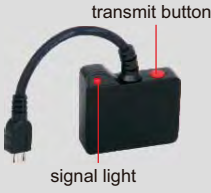
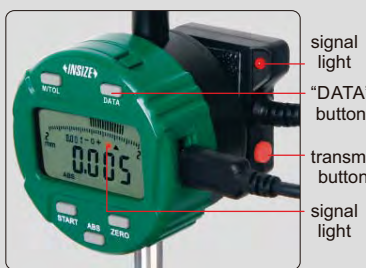

Code	Description	Transmitter	Connecting with measuring tool	Transmit data
7315-21	transmitter for digital calipers			<ul style="list-style-type: none"> Press the transmit button on the plug of cable, can also press the transmit button of the transmitter Data is transmitted once, the signal light of the transmitter flashes once
7315-22	transmitter for large digital calipers			<ul style="list-style-type: none"> Press the transmit button of the transmitter Data is transmitted once, the signal light of the transmitter flashes once
7315-30	transmitter for digital micrometers			<ul style="list-style-type: none"> Press the "data" button of digital micrometer, can also press the transmit button of the transmitter Data is transmitted once, the signal light of the transmitter flashes once, at the same time, the signal light on the digital micrometer flashes once
7315-31	transmitter for digital micrometers		 	<ul style="list-style-type: none"> Press the "data" button of digital micrometer Data is transmitted once, the signal light on the digital micrometer flashes once

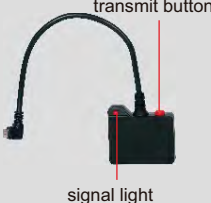
To be continued

Code	Description	Transmitter	Connecting with measuring tool	Transmit data
7315-50M	transmitter for digital indicators		 <p>for 2108, 2138, 2139 series digital indicators</p>	<ul style="list-style-type: none"> Press the "DATA" button of digital indicator, can also press the transmit button of the transmitter Data is transmitted once, the signal light of the transmitter flashes once, at the same time, the signal light on digital indicator flashes once
			 <p>for other digital indicators</p>	<ul style="list-style-type: none"> Press the transmit button of the transmitter Data is transmitted once, the signal light of the transmitter flashes once
7315-51	transmitter for digital indicators		 <p>for 2108, 2138, 2139 series digital indicators</p>  <p>back</p>	<ul style="list-style-type: none"> Press the "DATA" button of digital indicator Data is transmitted once, the signal light on digital indicator flashes once
7315-60	transmitter for high precision digital indicators			<ul style="list-style-type: none"> Press the transmit button of the transmitter Data is transmitted once, the signal light of the transmitter flashes once

To be continued

Continued from previous page

Code	Description	Transmitter	Connecting with measuring tool	Transmit data
7315-3350	transmitter for digital micrometers			<ul style="list-style-type: none"> Press the transmit button of the transmitter Data is transmitted once, the signal light of the transmitter flashes once
7315-1150	transmitter for digital height gages			<ul style="list-style-type: none"> Press the transmit button of the transmitter Data is transmitted once, the signal light of the transmitter flashes once
7315-1151	transmitter for digital height gages			<ul style="list-style-type: none"> Press the transmit button of the transmitter Data is transmitted once, the signal light of the transmitter flashes once
7315-2771	transmitter for digital protractor			<ul style="list-style-type: none"> Press the transmit button of the transmitter Data is transmitted once, the signal light of the transmitter flashes once



Receiver (keyboard signal)

- For computers and mobile phones
- Recognized as HID keyboard device, the transmitted data is recognized by computers or mobile phones as keyboard input data and press enter, such as 12.34↵. No need to install drivers and softwares
- Data can be transmitted to excel, word, txt etc.
- For any softwares which can receive keyboard signal

Code	Product	Description	Remark
7315-3		single channel receiver	connected with 1 transmitter only
7315-6		multichannel receiver	connected with 6 transmitters, each channel has status indicator
7315-7			

To be continued

Continued from previous page

Code	Product	Description	Remark
7315-8	 <p>micro USB port</p>	multichannel receiver	connected with 6 transmitters, each channel has status indicator
7315-9	 <p>lightning port</p>		

Receiver (text format, virtual com port)

- For computers with windows system
- Text format virtual com port, converted to keyboard format with supplied software
- Supplied with Excel directional input software
- Measurement data can be transmitted to excel, word, txt etc. and any software which receives keyboard signal

Code	Product	Description	Remark
7315-2	 <p>antenna</p> <p>USB port</p>	multichannel receiver	connected with maximum 16 transmitters, each of them has unique identification code

Excel directional input software

- Supplied with 7315-2 receiver
- The measurement data of multiple measuring tools can be transmitted to the designated area of excel, which facilitates data management and improves efficiency

Excel directional input software (included in 7315-2), application example 1

Set the display area of caliper at B4-B9, the readings of caliper are displayed at B4, B5...B9.
 Set the display area of micrometer at C4-C9, the readings of micrometer are displayed at C4, C5... C9.
 Set the display area of height gage at D4-D9, the readings of height gage are displayed at D4, D5... D9.

	A	B	C	D
1	Project	Length	Width	Height
2	Dimension and Tolerance	50±0.05	24±0.01	10+0.05/-0.06
3	Measuring tool	Caliper	Micrometer	Height gage
4	1	50.02	24.004	9.98
5	2	50.01	24.010	10.01
6	3	49.99	23.990	10.02
7	4	50.00	23.996	9.99
8	5	50.04	24.000	10.01
9	6	Channel 1	Channel 2	Channel 3

serial of workpieces the next data display area is indicated in green

Excel directional input software (included in 7315-2), application example 2

Set the display area of micrometer at B4-C9, data input is from the left to the right, the readings of micrometer are displayed at B4, C4, B5, C5... B9, C9.
 Set the display area of caliper at D4-D9, the readings of caliper are displayed at D4, D5... D9.
 Set the display area of depth gage at E4-E9, the readings of depth gage are displayed at E4, E5... E9.

	A	B	C	D	E
1	Project	External diameter1	External diameter2	Length	Depth
2	Dimension and Tolerance	Φ23+0.01/-0.02	Φ21+0.01/-0.02	50±0.04	28±0.05
3	Measuring tool	Micrometer	Micrometer	Caliper	Depth gage
4	1	23.010	21.008	49.98	28.01
5	2	23.010	21.000	49.98	27.98
6	3	22.999	21.000	50	28
7	4	23.007	20.998	50	28
8	5	23.000	20.985	50.01	28.01
9	6	23.008	Channel 1	Channel 2	Channel 3

serial of workpieces the next data display area is indicated in green

DATA OUTPUT CABLES (TEXT FORMAT, VIRTUAL COM PORT)

1) Data output cables with transmit box

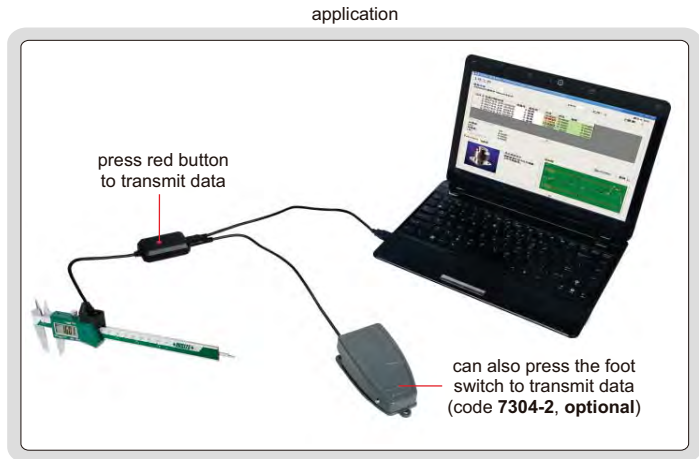
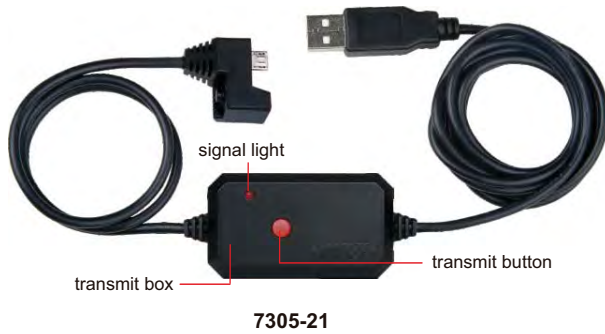









Single transmit (can be switched to continuous transmit)

Code	Description	Plug to measuring tool	Plug to computer	Connecting with measuring tool	Transmit data
7305-21	cable for digital calipers (length 3m)				<ul style="list-style-type: none"> Press the transmit button on the plug of cable, can also press the transmit button of the transmit box, or press the foot switch Data is transmitted once, the signal light of the transmit box flashes once
7305-R21					
7305-22	cable for large digital calipers (length 2.5m)				<ul style="list-style-type: none"> Press the transmit button of the transmit box, or press the foot switch Data is transmitted once, the signal light of the transmit box flashes once
7305-R22					
7305-30	cable for digital micrometers (length 2.5m)			 signal light "data" button	<ul style="list-style-type: none"> Press the "data" button of digital micrometer, can also press the transmit button of the transmit box, or press the foot switch Data is transmitted once, the signal light of the transmit box flashes once, at the same time, the signal light on the digital micrometer flashes once
7305-R30					
7305-31	cable for digital micrometers (length 2.5m)			 "data" button signal light IP65	<ul style="list-style-type: none"> Press the "data" button of digital micrometer, can also press the transmit button of the transmit box, or press the foot switch Data is transmitted once, the signal light of the transmit box flashes once, at the same time, the signal light on the digital micrometer flashes once
7305-R31					



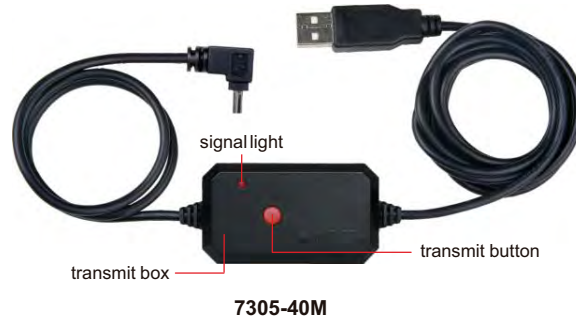

To be continued

Continued from previous page

Code	Description	Plug to measuring tool	Plug to computer	Connecting with measuring tool	Transmit data
7305-50M	cable for digital gages (length 2.5m)				<ul style="list-style-type: none"> Press the transmit button of the transmit box, or press the foot switch Data is transmitted once, the signal light of the transmit box flashes once
7305-R50M					
7305-1150	cable for digital height gages (length 2.5m)				<ul style="list-style-type: none"> Press the transmit button of the transmit box, or press the foot switch Data is transmitted once, the signal light of the transmit box flashes once
7305-R1150					



Continuous transmit (can be switched to single transmit)

Code	Description	Plug to measuring tool	Plug to computer	Connecting with measuring tool	Transmit data
7305-40M	cable for digital indicators (length 2.5m)			 <p>for 2108, 2138, 2139 series digital indicators</p>	<p>Continuous transmit is controlled in software</p> <p>Single transmit:</p> <ul style="list-style-type: none"> Press the "DATA" button of digital indicator, can also press the transmit button of the transmit box, or press the foot switch Data is transmitted once, the signal light of the transmit box flashes once, at the same time, the signal light on digital indicator flashes once <p>Note: long press transmit button to zero the digital indicators; software of data transmit is included</p>
				 <p>for other digital indicators</p>	<p>Continuous transmit is controlled in software</p> <p>Single transmit:</p> <ul style="list-style-type: none"> Press the transmit button of the transmit box, or press the foot switch Data is transmitted once, the signal light of the transmit box flashes once <p>Note: long press transmit button to zero the digital indicators; software of data transmit is included</p>

To be continued

Continued from previous page

Code	Description	Plug to measuring tool	Plug to computer	Connecting with measuring tool	Transmit data
7305-R40M	cable for digital indicators (length 2.5m)			<p>for 2108, 2138, 2139 series digital indicators</p>	<p>Continuous transmit is controlled in software</p> <p>Single transmit:</p> <ul style="list-style-type: none"> Press the "DATA" button of digital indicator, can also press the transmit button of the transmit box, or press the foot switch Data is transmitted once, the signal light of the transmit box flashes once, at the same time, the signal light on digital indicator flashes once <p>Note: long press transmit button to zero the digital indicators; software of data transmit is included</p>
				<p>for other digital indicators</p>	<p>Continuous transmit is controlled in software</p> <p>Single transmit:</p> <ul style="list-style-type: none"> Press the transmit button of the transmit box, or press the foot switch Data is transmitted once, the signal light of the transmit box flashes once <p>Note: long press transmit button to zero the digital indicators; software of data transmit is included</p>

Software (included in 7305-40M and 7305-R40M)

- Real-time display
- Tolerance setting, automatic judgment, out-of-tolerance alarm
- Real time statistics: max, min, average, Go/No-Go number
- Can save results as Excel

export Excel

real-time display

setting zero of digital indicators

measurement results and judgment

setting tolerance and sampling period

To be continued

- Baud: 9600bps
Data bit: 8
Stop bit 1
Check bit: None
No flow control

▪ Data output format

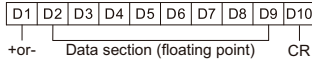

Data format example	
Display	Output
1.234	→ +0001.234 ✓
-1.234	→ -0001.234 ✓

▪ Data output format with ID number



Data format example	
Display	Output
1.234	→ 4109210605 +0001.234 ✓
-1.234	→ 4109210605 -0001.234 ✓

- The data transmission mode can be switched: single or continuous;
The data output format can be switched: with ID number or without ID number;
Data of digital indicators can be transmitted by instruction;
The digital indicators can be zeroed by instruction

▪ Pin definition of RS232 plug:



Pin No.	Symbol	Description
2	TXD	Data OUT
3	RXD	Data IN
4	VDD	+5V Power
5	GND	Ground

2) Data output cables without transmit box



7305-G3350

application



Single transmit

Code	Description	Plug to measuring tool	Plug to computer	Connecting with measuring tool	Transmit data
7305-G60	cable for high precision digital indicators (length 3m)				<ul style="list-style-type: none"> ▪ Press the "DATA" button of high precision digital indicator
7305-G3350	cable for digital micrometers (length 3m)				<ul style="list-style-type: none"> ▪ Press the "DATA" button of digital micrometer

- Baud: 9600bps
Data bit: 8
Stop bit 1
Check bit: None
No flow control

▪ Data output format

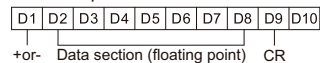

Data format example	
Display	Output
1.234	→ +0001.234 ✓
-1.234	→ -0001.234 ✓

- Data of high precision digital indicators can be transmitted by instruction;
The high precision digital indicators can be zeroed by instruction

DATA OUTPUT CABLES (KEYBOARD FORMAT)

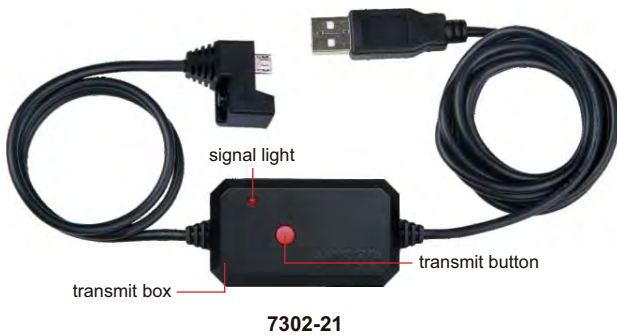



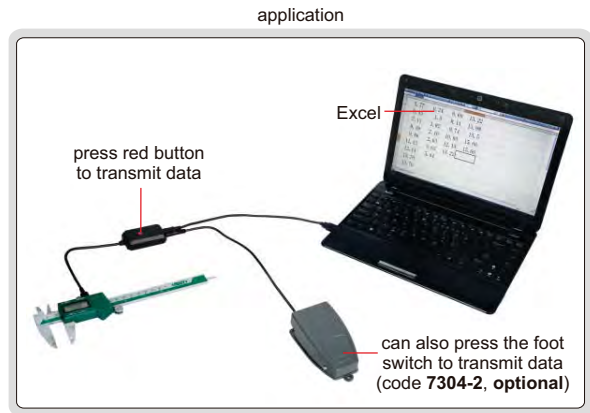









7302-21



- Recognized as HID keyboard device by computer, no need to install drivers and softwares
- Data can be transmitted to Excel, Word, txt and other files (press transmit button, which is recognized by the computer as keyboard input data and press enter, such as 12.34€)
- For any softwares which can receive keyboard signal
- Optional accessory: foot switch (code: **7304-2**), hub (code: **7324-HUB4**, **7324-HUB7**), extension cables (code: **7325-ADD5**, **7325-ADD10**)

Code	Description	Plug	Connecting with measuring tool	Transmit data
7302-21	cable for digital calipers (length 3m)			<ul style="list-style-type: none"> ▪ Press the transmit button on the plug of cable, can also press the transmit button of the transmit box, or press the foot switch ▪ Data is transmitted once, the signal light of the transmit box flashes once
7302-22	cable for large digital calipers (length 2.5m)			<ul style="list-style-type: none"> ▪ Press the transmit button of the transmit box, or press the foot switch ▪ Data is transmitted once, the signal light of the transmit box flashes once
7302-30	cable for digital micrometers (length 2.5m)			<ul style="list-style-type: none"> ▪ Press the "data" button of digital micrometer, can also press the transmit button of the transmit box, or press the foot switch ▪ Data is transmitted once, the signal light of the transmit box flashes once, at the same time, the signal light on the digital micrometer flashes once
7302-31	cable for digital micrometers (length 2.5m)			<ul style="list-style-type: none"> ▪ Press the "data" button of digital micrometer, can also press the transmit button of the transmit box, or press the foot switch ▪ Data is transmitted once, the signal light of the transmit box flashes once, at the same time, the signal light on the digital micrometer flashes once

To be continued

Code	Description	Plug	Connecting with measuring tool	Transmit data
7302-50M	cable for digital gages (length 2.5m)			<ul style="list-style-type: none"> Press the transmit button of the transmit box, or press the foot switch Data is transmitted once, the signal light of the transmit box flashes once
7302-40M	cable for digital indicators (length 2.5m)		 <p>for 2108, 2138, 2139 series digital indicators</p>	<ul style="list-style-type: none"> Press the "DATA" button of digital indicator, can also press the transmit button of the transmit box, or press the foot switch Data is transmitted once, the signal light of the transmit box flashes once, at the same time, the signal light on digital indicator flashes once <p>Note: long press transmit button to zero the digital indicators</p>
			 <p>for other digital indicators</p>	<ul style="list-style-type: none"> Press the transmit button of the transmit box, or press the foot switch Data is transmitted once, the signal light of the transmit box flashes once <p>Note: long press transmit button to zero the digital indicators</p>
7302-60	cable for high precision digital indicators (length 2.5m)		 <p>"DATA" button</p>	<ul style="list-style-type: none"> Press the "DATA" button of high precision digital indicator, can also press the transmit button of the transmit box, or press the foot switch Data is transmitted once, the signal light of the transmit box flashes once
7302-3350	cable for digital micrometers (length 2.5m)		 <p>"DATA" button</p>	<ul style="list-style-type: none"> Press the "DATA" button of digital micrometer, can also press the transmit button of the transmit box, or press the foot switch Data is transmitted once, the signal light of the transmit box flashes once
7302-1151	cable for digital height gages (length 2.5m)			<ul style="list-style-type: none"> Press the transmit button of the transmit box, or press the foot switch Data is transmitted once, the signal light of the transmit box flashes once
7302-SPC7	cable for digital height gages (length 2.5m)			<ul style="list-style-type: none"> Press the transmit button of the transmit box, or press the foot switch Data is transmitted once, the signal light of the transmit box flashes once

INTERFACE BOX AND DATA OUTPUT CABLES



**8-channel interface box
7210-2**



**data output cable
7305-R40M**

application



- The interface box can be connected to digital measuring tools, such as calipers, micrometers, indicators (7305-R series data output cables are needed)
- The interface box is supplied with Excel directional input software
- The interface box can be connected with 8 data output cables, each of them has unique identification code

INTERFACE BOX SPECIFICATION

Code	7210-2
Quantity of digital measuring tools to be connected	8 pcs
Output port	USB (virtual serial signal)

Excel directional input software

- Supplied with 7210-2 interface box
- The measurement data of multiple measuring tools can be transmitted to the designated area of Excel, which is convenient for data management and improves efficiency

Excel directional input software application example 1

Set the display area of caliper at B4-B9, the readings of caliper are displayed at B4, B5...B9. Set the display area of micrometer at C4-C9, the readings of micrometer are displayed at C4, C5... C9. Set the display area of height gage at D4-D9, the readings of height gage are displayed at D4, D5... D9.

	A	B	C	D
1	Project	Length	Width	Height
2	Dimension and Tolerance	50±0.05	24±0.01	10+0.05/-0.06
3	Measuring tool	Caliper	Micrometer	Height gage
4	1	50.02	24.004	9.98
5	2	50.01	24.010	10.01
6	3	49.99	23.990	10.02
7	4	50.00	23.996	9.99
8	5	50.04	24.000	10.01
9	6	Channel 1	Channel 2	Channel 3

serial of workpieces

the next data display area is indicated in green

Excel directional input software application example 2

Set the display area of micrometer at B4-C9, data input is from the left to the right, the readings of micrometer are displayed at B4, C4, B5, C5... B9, C9. Set the display area of caliper at D4-D9, the readings of caliper are displayed at D4, D5... D9. Set the display area of depth gage at E4-E9, the readings of depth gage are displayed at E4, E5... E9.

	A	B	C	D	E
1	Project	External diameter1	External diameter2	Length	Depth
2	Dimension and Tolerance	Φ23+0.01/-0.02	Φ21+0.01/-0.02	50±0.04	28±0.05
3	Measuring tool	Micrometer	Micrometer	Caliper	Depth gage
4	1	23.010	21.008	49.98	28.01
5	2	23.010	21.000	49.98	27.98
6	3	22.999	21.000	50	28
7	4	23.007	20.998	50	28
8	5	23.000	20.985	50.01	28.01
9	6	23.008	Channel 1	Channel 2	Channel 3











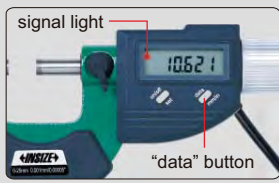

serial of workpieces

the next data display area is indicated in green

To be continued

Continued from previous page

DATA OUTPUT CABLE SPECIFICATION

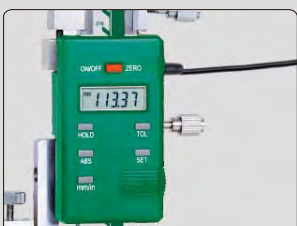
Code	Description	Plug to measuring tool	Connecting with measuring tool	Transmit data
7305-R21	cable for digital calipers (length 3m)			<ul style="list-style-type: none"> Press the transmit button on the plug of cable, can also press the transmit button of the transmit box, or press the foot switch Data is transmitted once, the signal light of the transmit box flashes once
7305-R22	cable for large digital calipers (length 2.5m)			<ul style="list-style-type: none"> Press the transmit button of the transmit box, or press the foot switch Data is transmitted once, the signal light of the transmit box flashes once
7305-R30	cable for digital micrometers (length 2.5m)		 	<ul style="list-style-type: none"> Press the "data" button of digital micrometer, can also press the transmit button of the transmit box, or press the foot switch Data is transmitted once, the signal light of the transmit box flashes once, at the same time, the signal light on the digital micrometer flashes once
7305-R40M	cable for digital indicators (length 2.5m)		 <p>for 2108, 2138, 2139 series digital indicators</p>	<ul style="list-style-type: none"> Press the "DATA" button of digital indicator, can also press the transmit button of the transmit box, or press the foot switch Data is transmitted once, the signal light of the transmit box flashes once, at the same time, the signal light on digital indicator flashes once
			 <p>for other digital indicators</p>	<ul style="list-style-type: none"> Press the transmit button of the transmit box, or press the foot switch Data is transmitted once, the signal light of the transmit box flashes once
7305-R50M	cable for digital gages (length 2.5m)			<ul style="list-style-type: none"> Press the transmit button of the transmit box, or press the foot switch Data is transmitted once, the signal light of the transmit box flashes once
7305-R1150	cable for digital height gages (length 2.5m)			<ul style="list-style-type: none"> Press the transmit button of the transmit box, or press the foot switch Data is transmitted once, the signal light of the transmit box flashes once

**DISPLAY UNIT
CODE 7106-1A**

REFER TO PAGE 229 FOR DETAILS



connected with digital indicator



MULTICHANNEL INTERFACE BOXES

REFER TO PAGE 230 FOR DETAILS



7107-1

connected with digital indicators

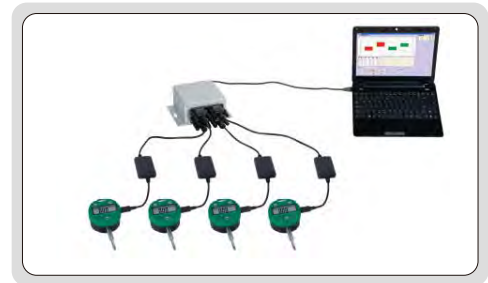

HUBS



7324-HUB4



7324-HUB7

■ For USB plug data cable

application

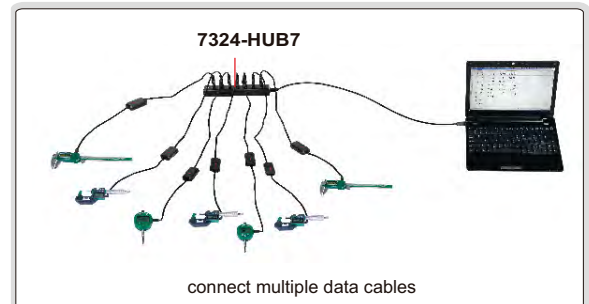

connect multiple data cables

Code	Description	Applicable products
7324-HUB4	4-channel hub (length 0.2m, USB computer plug)	7302 series data cables
7324-HUB7	7-channel hub (length 1m, USB computer plug)	7305 series data cables (USB plug)

EXTENSION CABLES

1



7325-ADD5

application

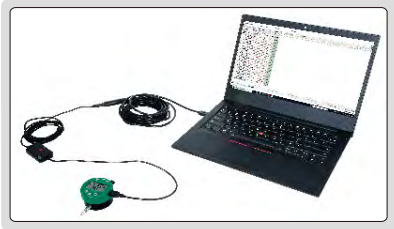

Code	Description	Applicable products
7325-ADD5	data extension cable (length 5m, USB plug)	7302 series data cables
7325-ADD10	data extension cable (length 10m, USB plug)	7305 series data cables (USB plug)

FOOT SWITCH

- For data transmission



7304-2

application

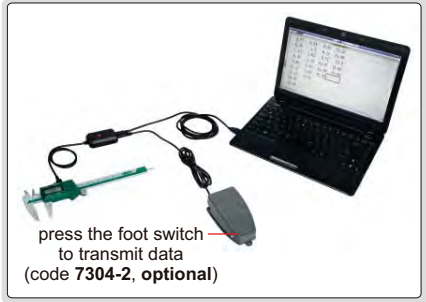

Code	Description	Applicable products
7304-2	data transmission foot switch with cable (length 2m)	7302 series data cables 7305 series data cables

OK/NG INPUT SWITCHES



7327-FS



7327-SW

application



- Used with 7317 software, output OK or NG
- USB plug, length 1.5m

Code	Description
7327-FS	foot switch for OK/NG input
7327-SW	hand switch for OK/NG input



Digital Calipers
Page 19-26



Dial Calipers
Page 26



Vernier Calipers
Page 26-29



Depth Base Attachments
Page 29



Caliper/Height Gage Checkers
Page 30



Caliper End Grinding Machines
Page 30



Accessory Sets For Digital Calipers
Page 31-32



Large Digital Calipers
Page 32-35



Large Vernier Calipers
Page 35-37



Special Purpose Calipers
Page 38-64

ATTENTION: THE WORKING LIFE OF A BATTERY IS ABOUT 3-5 MONTHS

INSPECTION CERTIFICATE

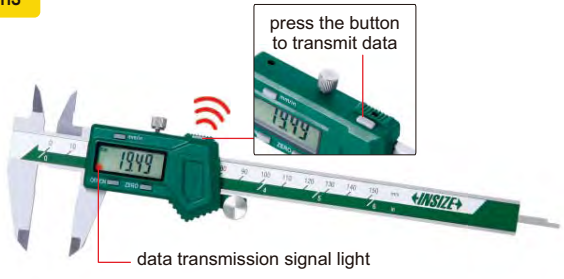

1113-150

- Non waterproof
- Built-in wireless data transmission module, Zigbee signal
- Transmission distance is 10 meter (under the condition of no obstruction and no electromagnetic interference)
- Resolution: 0.01mm/0.0005"
- Buttons: on/off, zero, mm/inch, data transmission
- Automatic power off, move the digital unit to turn on power
- Battery CR2032
- Made of stainless steel
- Optional accessory: receiver (code 7315-2/3/6/7/8/9)

WIRELESS DIGITAL CALIPERS

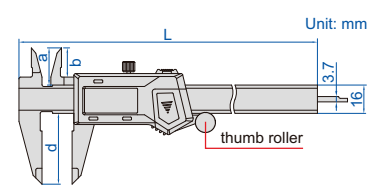

application

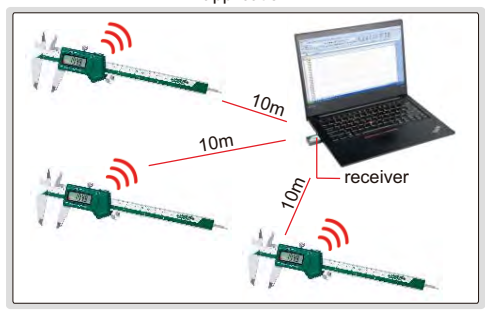

receiver (optional)

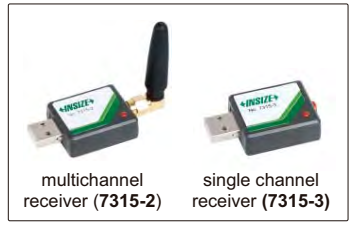

Code	Range	Accuracy	Thumb roller	L	a	b	d
1113-150 *	0-150mm/0-6"	±0.03mm	with	236	21	16	40
1113-200 *	0-200mm/0-8"	±0.03mm	with	286	24	19	50
1113-300 *	0-300mm/0-12"	±0.03mm	with	400	25	20.5	60
1113-150W *	0-150mm/0-6"	±0.03mm	without	236	21	16	40
1113-200W *	0-200mm/0-8"	±0.03mm	without	286	24	19	50
1113-300W *	0-300mm/0-12"	±0.03mm	without	400	25	20.5	60

*Supplied with manufacturer inspection certificate

ATTENTION: IT IS NECESSARY TO SET ZERO AFTER POWER ON EACH TIME

ATTENTION: NO DATA OUTPUT

IP67 WATERPROOF

IP67 WATERPROOF DIGITAL CALIPERS

INSPECTION CERTIFICATE



1118-150B



1118-150R

- IP67 dust/waterproof
- Resolution: 0.01mm/0.0005"
- Button function: zero, on/off, mm/inch, ABS/REL, hold
- Battery CR2032
- Meet DIN862
- Made of stainless steel

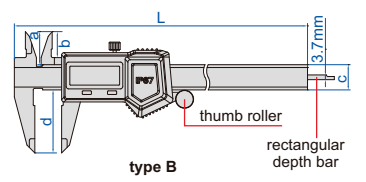

type B

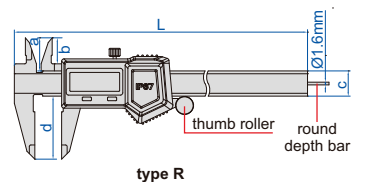

type R

Code	Range	Accuracy	Thumb roller	Type	L	a	b	c	d
1118-150B *	0-150mm/0-6"	±0.03mm	with	B	236mm	21mm	16mm	16mm	40mm
1118-200B *	0-200mm/0-8"	±0.03mm	with	B	286mm	24mm	19mm	16mm	50mm
1118-300B *	0-300mm/0-12"	±0.03mm	with	B	400mm	25mm	20.5mm	16mm	60mm
1118-150BW *	0-150mm/0-6"	±0.03mm	without	B	236mm	21mm	16mm	16mm	40mm
1118-200BW *	0-200mm/0-8"	±0.03mm	without	B	286mm	24mm	19mm	16mm	50mm
1118-300BW *	0-300mm/0-12"	±0.03mm	without	B	400mm	25mm	20.5mm	16mm	60mm
1118-150R *	0-150mm/0-6"	±0.03mm	with	R	236mm	21mm	16mm	16mm	40mm
1118-150RW *	0-150mm/0-6"	±0.03mm	without	R	236mm	21mm	16mm	16mm	40mm

*Supplied with manufacturer inspection certificate

IP67 WATERPROOF DIGITAL CALIPERS

ATTENTION:
NO DATA OUTPUT

IP67
WATERPROOF

- IP67 dust/waterproof
- Resolution: 0.01mm/0.0005"
- Button function: zero, on/off, mm/inch
- Battery CR2032
- Automatic power off
- Meet DIN862
- Made of stainless steel



1115-150

INSPECTION
CERTIFICATE

Code	Range	Accuracy	L	a	b	c	d
1115-150 *	0-150mm/0-6"	±0.03mm	235mm	20mm	15mm	16mm	40mm
1115-200 *	0-200mm/0-8"	±0.03mm	287mm	24mm	19mm	16mm	50mm
1115-300 *	0-300mm/0-12"	±0.03mm	388mm	26mm	21mm	16mm	60mm

*Supplied with manufacturer inspection certificate

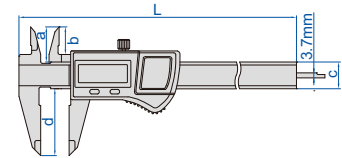

DIGITAL CALIPERS (ABSOLUTE SYSTEM)

DATA
OUTPUT

INSPECTION
CERTIFICATE

- Non waterproof
- Absolute system, low power consumption, long battery life
- Resolution: 0.01mm/0.0005"
- Buttons: on/off, mm/inch, ORIGIN, ZERO/ABS
- Automatic power off, move the digital unit to turn on power
- Battery CR2032
- Data output
- Meet DIN862
- Made of stainless steel
- Optional accessory: wireless transmitter, code 7315-22 page 4, data output cable (keyboard format), code 7302-22 page 12



1103-150

Code	Range	Accuracy	Thumb roller	L	a	b	d
1103-150 *	0-150mm/0-6"	±0.03mm	with	236mm	21mm	16.5mm	40mm
1103-200 *	0-200mm/0-8"	±0.03mm	with	286mm	24mm	19.5mm	50mm
1103-300 *	0-300mm/0-12"	±0.03mm	with	400mm	26mm	21.5mm	60mm
1103-150W *	0-150mm/0-6"	±0.03mm	without	236mm	21mm	16.5mm	40mm
1103-200W *	0-200mm/0-8"	±0.03mm	without	286mm	24mm	19.5mm	50mm
1103-300W *	0-300mm/0-12"	±0.03mm	without	400mm	26mm	21.5mm	60mm

*Supplied with manufacturer inspection certificate

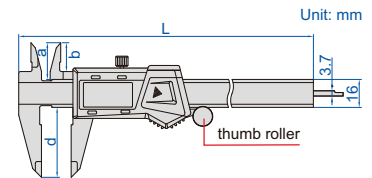

DIGITAL CALIPERS (FRACTION READING)

ATTENTION:
NO DATA OUTPUT

INSPECTION
CERTIFICATE

- Non waterproof
- Resolution: 0.01mm, 0.0005", 1/128"
- Buttons: unit (mm/in/fraction), ABS, on/off, zero
- Absolute and incremental measurement
- Battery CR2032, automatic power off
- Meet DIN862
- Made of stainless steel



1102-150

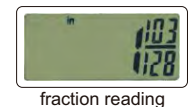

fraction reading

Code	Range	Accuracy	Thumb roller	L	a	b	d
1102-150 *	0-150mm/0-6"	±0.03mm	with	234mm	20mm	15mm	40mm
1102-200 *	0-200mm/0-8"	±0.03mm	with	286mm	24mm	19mm	50mm
1102-300 *	0-300mm/0-12"	±0.03mm	with	390mm	26mm	21.5mm	60mm
1102-150W *	0-150mm/0-6"	±0.03mm	without	234mm	20mm	15mm	40mm
1102-200W *	0-200mm/0-8"	±0.03mm	without	286mm	24mm	19mm	50mm
1102-300W *	0-300mm/0-12"	±0.03mm	without	390mm	26mm	21.5mm	60mm

*Supplied with manufacturer inspection certificate

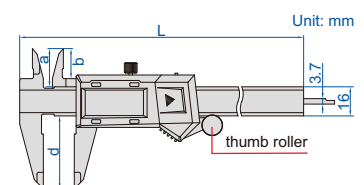

ATTENTION:
NO DATA OUTPUT



DIGITAL CALIPERS

2

- Non waterproof
- Zinc alloy housing for digital unit
- Resolution: 0.01mm/0.0005"
- Buttons: zero, on/off, mm/inch
- Automatic power off, move the digital unit to turn on power
- Battery CR2032
- Meet DIN862
- Made of stainless steel



1114-150A

Code	Range	Accuracy	Thumb roller	L	a	b	c	d
1114-150A *	0-150mm/0-6"	±0.03mm	with	236mm	21mm	16mm	16mm	40mm
1114-200A *	0-200mm/0-8"	±0.03mm	with	286mm	24mm	19mm	16mm	50mm
1114-300A *	0-300mm/0-12"	±0.03mm	with	400mm	25mm	20.5mm	17mm	60mm
1114-150AW *	0-150mm/0-6"	±0.03mm	without	236mm	21mm	16mm	16mm	40mm
1114-200AW *	0-200mm/0-8"	±0.03mm	without	286mm	24mm	19mm	16mm	50mm
1114-300AW *	0-300mm/0-12"	±0.03mm	without	400mm	25mm	20.5mm	17mm	60mm

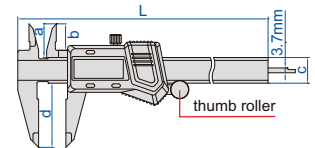

* Supplied with manufacturer inspection certificate

DATA
OUTPUT



POPULAR
MODEL

DIGITAL CALIPERS (STANDARD TYPE)

- Non waterproof
- Resolution: 0.01mm/0.0005"
- Buttons: on/off, zero, mm/inch
- Automatic power off, move the digital unit to turn on power
- Battery CR2032
- Data output
- Meet DIN862
- Made of stainless steel
- Optional accessory: data output cable (code 7315-21 page 4, 7302-21 page 12)



1108-150

Code	Range	Accuracy	Thumb roller	L	a	b	c	d
1108-150 *	0-150mm/0-6"	±0.02mm	with	236mm	21mm	16mm	16mm	40mm
1108-200 *	0-200mm/0-8"	±0.03mm	with	286mm	24mm	19mm	16mm	50mm
1108-250 *	0-250mm/0-10"	±0.03mm	with	350mm	25mm	20.5mm	16mm	60mm
1108-300 *	0-300mm/0-12"	±0.03mm	with	400mm	25mm	20.5mm	16mm	60mm
1108-150W *	0-150mm/0-6"	±0.02mm	without	236mm	21mm	16mm	16mm	40mm
1108-200W *	0-200mm/0-8"	±0.03mm	without	286mm	24mm <td 19mm	16mm	50mm	
1108-300W *	0-300mm/0-12"	±0.03mm	without	400mm	25mm	20.5mm	16mm	60mm

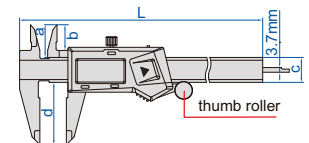

* Supplied with manufacturer inspection certificate

DATA
OUTPUT



HEAVY DUTY 300mm DIGITAL CALIPERS

- Non waterproof
- Resolution: 0.01mm/0.0005"
- Buttons: on/off, zero, mm/inch
- Automatic power off, move the digital unit to turn on power
- Battery CR2032
- Data output
- Meet DIN862
- Made of stainless steel
- Optional accessory: data output cable (code 7315-22 page 4, 7302-22 page 12)



1196-300

Code	Range	Thumb roller	Accuracy
1196-300 *	0-300mm/0-12"	with	±0.03mm
1196-300W *	0-300mm/0-12"	without	±0.03mm

* Supplied with manufacturer inspection certificate

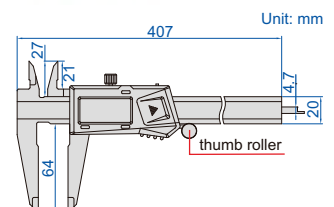

METRIC DIGITAL CALIPERS



LOCK READING WITH "HOLD" BUTTON

DATA OUTPUT

- Non waterproof
- Resolution: 0.01mm
- Buttons: on/off, zero, hold
- Automatic power off, move the digital unit to turn on power
- Battery CR2032
- Data output
- Meet DIN862
- Made of stainless steel
- Optional accessory: data output cable (code 7315-21 page 4, 7302-21 page 12)



1109-150

Code	Range	Accuracy	Thumb roller	L	a	b	c	d
1109-150 *	0-150mm	±0.03mm	with	236mm	21mm	16mm	16mm	40mm
1109-200 *	0-200mm	±0.03mm	with	286mm	24mm	19mm	16mm	50mm
1109-300 *	0-300mm	±0.03mm	with	400mm	25mm	20.5mm	16mm	60mm
1109-150W *	0-150mm	±0.03mm	without	236mm	21mm	16mm	16mm	40mm
1109-200W *	0-200mm	±0.03mm	without	286mm	24mm	19mm	16mm	50mm
1109-300W *	0-300mm	±0.03mm	without	400mm	25mm	20.5mm	16mm	60mm

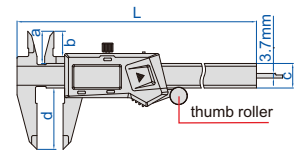

* Supplied with manufacturer inspection certificate

DIGITAL CALIPERS WITH ROUND DEPTH BAR



DATA OUTPUT



1119-150



round depth bar Ø1.6mm

- Non waterproof
- Resolution: 0.01mm/0.0005"
- Buttons: on/off, zero, mm/inch
- Automatic power off, move the digital unit to turn on power
- Battery CR2032
- Meet DIN862
- Made of stainless steel

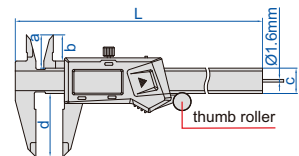

With data interface (data output cable code 7315-21 page 4, 7302-21 page 12, optional)

Code	Range	Accuracy	Thumb roller	L	a	b	c	d
1119-150 *	0-150mm/0-6"	±0.03mm	with	236mm	21mm	16mm	16mm	40mm
1119-150W *	0-150mm/0-6"	±0.03mm	without	236mm	21mm	16mm	16mm	40mm

Built-in wireless (receiver code 7315-2/3/6/7/8/9 is required)

Code	Range	Accuracy	Thumb roller	L	a	b	c	d
1119-150WL *	0-150mm/0-6"	±0.03mm	with	236mm	21mm	16mm	16mm	40mm
1119-150WWL *	0-150mm/0-6"	±0.03mm	without	236mm	21mm	16mm	16mm	40mm

* Supplied with manufacturer inspection certificate



DATA
OUTPUT

INSPECTION
CERTIFICATE

LEFT HAND DIGITAL CALIPERS

2

- Non waterproof
- Designed for left handed users
- Resolution: 0.01mm/0.0005"
- Buttons: on/off, zero, mm/inch
- Automatic power off, move the digital unit to turn on power
- Battery CR2032
- Data output
- Meet DIN862
- Made of stainless steel
- Optional accessory: data output cable (code 7315-22 page 4, 7302-22 page 12)



1130-150

Code	Range	Accuracy	Thumb roller	L	a	b	d
1130-150*	0-150mm/0-6"	±0.03mm	with	236mm	21mm	16mm	40mm
1130-200*	0-200mm/0-8"	±0.03mm	with	286mm	24mm	19mm	50mm
1130-300*	0-300mm/0-12"	±0.03mm	with	400mm	25mm	20.5mm	60mm
1130-150W*	0-150mm/0-6"	±0.03mm	without	236mm	21mm	16mm	40mm
1130-200W*	0-200mm/0-8"	±0.03mm	without	286mm	24mm	19mm	50mm
1130-300W*	0-300mm/0-12"	±0.03mm	without	400mm	25mm	20.5mm	60mm

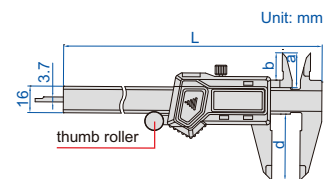

*Supplied with manufacturer inspection certificate

DATA
OUTPUT

INSPECTION
CERTIFICATE

DIGITAL CALIPERS WITH CERAMIC TIPPED JAWS



1193-150

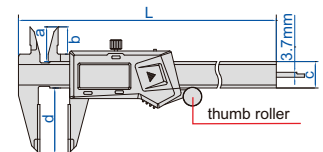

ceramic
tipped jaws



- Non waterproof
- Ceramic tipped jaws for outside measurement, extremely wear-resistant, non-magnetic and non electric conductive
- Resolution: 0.01mm/0.0005"
- Buttons: on/off, zero, mm/inch
- Automatic power off, move the digital unit to turn on power
- Battery CR2032, made of stainless steel
- Meet DIN862

With data interface (data output cable code 7315-21 page 4, 7302-21 page 12, optional)

Code	Range	Accuracy	Thumb roller	L	a	b	c	d
1193-150*	0-150mm/0-6"	±0.03mm	with	235mm	21mm	16.5mm	16mm	40mm
1193-200*	0-200mm/0-8"	±0.03mm	with	287mm	24mm	20mm	16mm	50mm
1193-300*	0-300mm/0-12"	±0.03mm	with	390mm	26mm	21.5mm	16mm	60mm
1193-150W*	0-150mm/0-6"	±0.03mm	without	235mm	21mm	16.5mm	16mm	40mm
1193-200W*	0-200mm/0-8"	±0.03mm	without	297mm	24mm	20mm	16mm	50mm
1193-300W*	0-300mm/0-12"	±0.03mm	without	390mm	26mm	21.5mm	16mm	60mm

Built-in wireless (receiver code 7315-2/3/6/7/8/9 is required)

Code	Range	Accuracy	Thumb roller	L	a	b	c	d
1193-150WL*	0-150mm/0-6"	±0.03mm	with	235mm	21mm	16.5mm	16mm	40mm
1193-200WL*	0-200mm/0-8"	±0.03mm	with	287mm	24mm	20mm	16mm	50mm
1193-300WL*	0-300mm/0-12"	±0.03mm	with	390mm	26mm	21.5mm	16mm	60mm
1193-150WWL*	0-150mm/0-6"	±0.03mm	without	235mm	21mm	16.5mm	16mm	40mm
1193-200WWL*	0-200mm/0-8"	±0.03mm	without	297mm	24mm	20mm	16mm	50mm
1193-300WWL*	0-300mm/0-12"	±0.03mm	without	390mm	26mm	21.5mm	16mm	60mm

*Supplied with manufacturer inspection certificate

DIGITAL CALIPERS WITH CARBIDE TIPPED JAWS

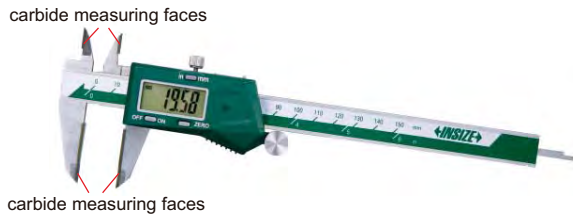

1110-150A

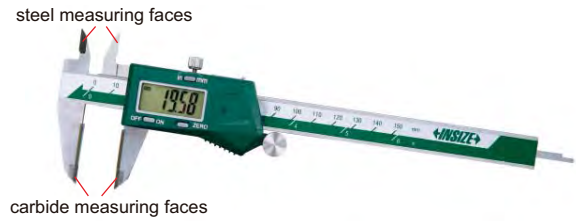

1110-150B



1110-150C

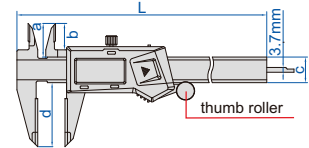

- Resolution: 0.01mm/0.0005"
- Buttons: on/off, zero, mm/inch
- Automatic power off, move the digital unit to turn on power
- Battery CR2032
- Meet DIN862
- Made of stainless steel

Non waterproof, with data interface (data output cable code 7315-21 page 4, 7302-21 page 12, optional)

Code	Range	Accuracy	Thumb roller	L	a	b	c	d	Remark
1110-150A *	0-150mm/0-6"	±0.03mm	with	236mm	21mm	16mm	16mm	40mm	carbide tipped upper and lower jaws
1110-200A *	0-200mm/0-8"	±0.03mm	with	286mm	24mm	19mm	16mm	50mm	carbide tipped upper and lower jaws
1110-300A *	0-300mm/0-12"	±0.03mm	with	400mm	25mm	20.5mm	16mm	60mm	carbide tipped upper and lower jaws
1110-150AW *	0-150mm/0-6"	±0.03mm	without	236mm	21mm	16mm	16mm	40mm	carbide tipped upper and lower jaws
1110-200AW *	0-200mm/0-8"	±0.03mm	without	286mm	24mm	19mm	16mm	50mm	carbide tipped upper and lower jaws
1110-300AW *	0-300mm/0-12"	±0.03mm	without	400mm	25mm	20.5mm	16mm	60mm	carbide tipped upper and lower jaws
1110-150B *	0-150mm/0-6"	±0.03mm	with	236mm	21mm	16mm	16mm	40mm	carbide tipped lower jaws
1110-200B *	0-200mm/0-8"	±0.03mm	with	286mm	24mm	19mm	16mm	50mm	carbide tipped lower jaws
1110-300B *	0-300mm/0-12"	±0.03mm	with	400mm	25mm	20.5mm	16mm	60mm	carbide tipped lower jaws
1110-150BW *	0-150mm/0-6"	±0.03mm	without	236mm	21mm	16mm	16mm	40mm	carbide tipped lower jaws
1110-200BW *	0-200mm/0-8"	±0.03mm	without	286mm	24mm	19mm	16mm	50mm	carbide tipped lower jaws
1110-300BW *	0-300mm/0-12"	±0.03mm	without	400mm	25mm	20.5mm	16mm	60mm	carbide tipped lower jaws

Non waterproof, built-in wireless (receiver code 7315-2/3/6/7/8/9 is required)

Code	Range	Accuracy	Thumb roller	L	a	b	c	d	Remark
1110-150AWL *	0-150mm/0-6"	±0.03mm	with	236mm	21mm	16mm	16mm	40mm	carbide tipped upper and lower jaws
1110-200AWL *	0-200mm/0-8"	±0.03mm	with	286mm	24mm	19mm	16mm	50mm	carbide tipped upper and lower jaws
1110-300AWL *	0-300mm/0-12"	±0.03mm	with	400mm	25mm	20.5mm	16mm	60mm	carbide tipped upper and lower jaws
1110-150AWWL *	0-150mm/0-6"	±0.03mm	without	236mm	21mm	16mm	16mm	40mm	carbide tipped upper and lower jaws
1110-200AWWL *	0-200mm/0-8"	±0.03mm	without	286mm	24mm	19mm	16mm	50mm	carbide tipped upper and lower jaws
1110-300AWWL *	0-300mm/0-12"	±0.03mm	without	400mm	25mm	20.5mm	16mm	60mm	carbide tipped upper and lower jaws
1110-150BWL *	0-150mm/0-6"	±0.03mm	with	236mm	21mm	16mm	16mm	40mm	carbide tipped lower jaws
1110-200BWL *	0-200mm/0-8"	±0.03mm	with	286mm	24mm	19mm	16mm	50mm	carbide tipped lower jaws
1110-300BWL *	0-300mm/0-12"	±0.03mm	with	400mm	25mm	20.5mm	16mm	60mm	carbide tipped lower jaws
1110-150BWWL *	0-150mm/0-6"	±0.03mm	without	236mm	21mm	16mm	16mm	40mm	carbide tipped lower jaws
1110-200BWWL *	0-200mm/0-8"	±0.03mm	without	286mm	24mm	19mm	16mm	50mm	carbide tipped lower jaws
1110-300BWWL *	0-300mm/0-12"	±0.03mm	without	400mm	25mm	20.5mm	16mm	60mm	carbide tipped lower jaws

IP67 dust/waterproof, without data interface

Code	Range	Accuracy	Thumb roller	L	a	b	c	d	Remark
1110-150C *	0-150mm/0-6"	±0.03mm	with	236mm	21mm	16mm	16mm	40mm	carbide tipped upper and lower jaws
1110-150D *	0-150mm/0-6"	±0.03mm	with	236mm	21mm	16mm	16mm	40mm	carbide tipped lower jaws
1110-150CW *	0-150mm/0-6"	±0.03mm	without	236mm	21mm	16mm	16mm	40mm	carbide tipped upper and lower jaws
1110-150DW *	0-150mm/0-6"	±0.03mm	without	236mm	21mm	16mm	16mm	40mm	carbide tipped lower jaws

* Supplied with manufacturer inspection certificate

DIGITAL CALIPERS

2

DATA OUTPUT

- Non waterproof
- Resolution: 0.01mm/0.0005"
- Buttons: on/off, zero, mm/inch
- Automatic power off, move the digital unit to turn on power
- Battery CR2032
- Made of stainless steel



1170-300

With data interface (data output cable code 7315-21 page 4, 7302-21 page 12, optional)

Code	Range	Accuracy	a	c	d	e	L
1170-200	0-200mm/0-8"	±0.03mm	12mm	17mm	60mm	10mm	314mm
1170-306	0-300mm/0-12"	±0.04mm	12mm	17mm	60mm	10mm	420mm
1170-300	0-300mm/0-12"	±0.06mm	12mm	17mm	90mm	10mm	420mm

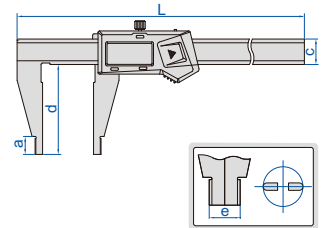

Built-in wireless (receiver code 7315-2/3/6/7/8/9 is required)

Code	Range	Accuracy	a	c	d	e	L
1170-200WL	0-200mm/0-8"	±0.03mm	12mm	17mm	60mm	10mm	314mm
1170-306WL	0-300mm/0-12"	±0.04mm	12mm	17mm	60mm	10mm	420mm
1170-300WL	0-300mm/0-12"	±0.06mm	12mm	17mm	90mm	10mm	420mm

DIGITAL CALIPERS

DATA OUTPUT

- Non waterproof
- Resolution: 0.01mm/0.0005"
- Buttons: on/off, zero, mm/inch
- Automatic power off, move the digital unit to turn on power
- Battery CR2032
- Made of stainless steel



1171-300

With data interface (data output cable code 7315-21 page 4, 7302-21 page 12, optional)

Code	Range	Accuracy	a	b	c	d	e	L
1171-200	0-200mm/0-8"	±0.03mm	12mm	38mm	17mm	60mm	10mm	320mm
1171-250	0-250mm/0-10"	±0.03mm	12mm	38mm	17mm	60mm	10mm	365mm
1171-306	0-300mm/0-12"	±0.04mm	12mm	38mm	17mm	60mm	10mm	420mm
1171-300	0-300mm/0-12"	±0.06mm	12mm	38mm	17mm	90mm	10mm	420mm

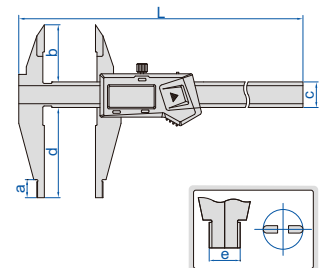

Built-in wireless (receiver code 7315-2/3/6/7/8/9 is required)

Code	Range	Accuracy	a	b	c	d	e	L
1171-200WL	0-200mm/0-8"	±0.03mm	12mm	38mm	17mm	60mm	10mm	320mm
1171-250WL	0-250mm/0-10"	±0.03mm	12mm	38mm	17mm	60mm	10mm	365mm
1171-306WL	0-300mm/0-12"	±0.04mm	12mm	38mm	17mm	60mm	10mm	420mm
1171-300WL	0-300mm/0-12"	±0.06mm	12mm	38mm	17mm	90mm	10mm	420mm

MINI DIGITAL CALIPERS

ATTENTION:
NO DATA OUTPUT

- Non waterproof
- Resolution: 0.01mm/0.0005"
- Buttons: zero, mm/inch, on/off
- Automatic power off, move the digital unit to turn on power
- Battery LR44
- Meet DIN862
- Made of stainless steel



1111-100A

Code	Range	Accuracy	L
1111-75A	0-75mm/0-3"	±0.02mm	144mm
1111-100A	0-100mm/0-4"	±0.02mm	170mm

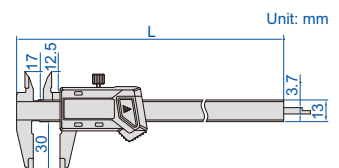

PLASTIC DIGITAL CALIPER

ATTENTION:
NO DATA OUTPUT

- Non waterproof
- Made of hard plastic, non-magnetic and non electric conductive
- Prevent workpieces from scratching by calipers
- Resolution: 0.01mm/0.0005"
- Buttons: on/off, zero, mm/inch
- Battery CR2032, automatic power off



1139-150

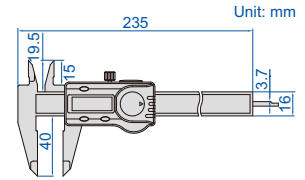

Code	Range	Accuracy
1139-150	0-150mm/0-6"	±0.1mm

DIAL CALIPERS

SHOCK PROOF

INSPECTION CERTIFICATE

- Shockproof dial indicator
- Made of stainless steel



1312-150A

Dial indicator graduation: 0.02mm (mm)

Code	Range	Accuracy	Thumb roller	L	a	b	c	d	D	t
1312-150A*	0-150mm	±0.03mm	with	235	21	16.5	16	40	∅39	6.5
1312-200A*	0-200mm	±0.03mm	with	288	24	19	16	48	∅39	6.5
1312-300A*	0-300mm	±0.03mm	with	410	28	22	20	62	∅44.5	7.5
1312-100AW*	0-100mm	±0.02mm	without	165	18	13	13	30	∅32	6

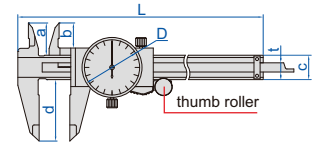

Dial indicator graduation: 0.01mm (mm)

Code	Range	Accuracy	Thumb roller	L	a	b	c	d	D	t
1311-150A*	0-150mm	±0.03mm	with	235	21	16.5	16	40	∅39	6.5
1311-200A*	0-200mm	±0.03mm	with	288	24	19	16	48	∅39	6.5
1311-300A*	0-300mm	±0.03mm	with	410	28	22	20	62	∅44.5	7.5

*Supplied with manufacturer inspection certificate

MINI VERNIER CALIPERS

- Meet DIN862
- Made of stainless steel
- Satin chrome plated reading surface

Code	Range	Graduation	Accuracy
1204-70	0-70mm	0.05mm	±0.05mm

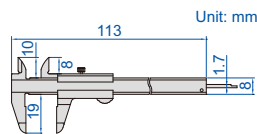

1204-70

Code	Range	Graduation	Accuracy
1203-1003	0-100mm	0.05mm	±0.05mm

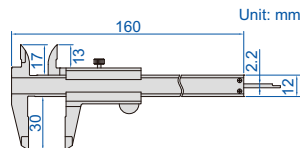

1203-1003

Code	Range	Graduation	Accuracy
1201-1003	0-100mm	0.05mm	±0.05mm

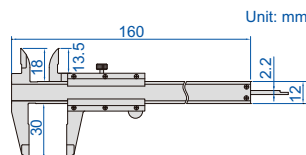

1201-1003

VERNIER CALIPERS

2

POPULAR MODEL

Graduation 0.05mm/1/128" (mm)

Code	Range	Accuracy	L	a	b	c	d
1205-150S	0-150mm/0-6"	±0.05mm	235	20.5	15.5	16	40
1205-200S	0-200mm/0-8"	±0.05mm	290	23.5	19	17	50
1205-250S	0-250mm/0-10"	±0.05mm	364	27.5	22	20	64
1205-300S	0-300mm/0-12"	±0.05mm	414	27.5	22	20	64



1205-150S

Graduation 0.05mm (mm)

Code	Range	Accuracy	L	a	b	c	d
1205-1503S	0-150mm	±0.05mm	235	20.5	15.5	16	40
1205-2003S	0-200mm	±0.05mm	290	23.5	19	17	50
1205-2503S	0-250mm	±0.05mm	350	26	21.5	16	60
1205-3003S	0-300mm	±0.05mm	414	27.5	22	20	64

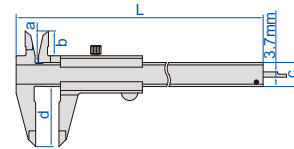

Graduation 0.02mm/0.001" (mm)

Code	Range	Accuracy	L	a	b	c	d
1205-1502S	0-150mm/0-6"	±0.03mm	235	20.5	15.5	16	40
1205-2002S	0-200mm/0-8"	±0.03mm	290	23.5	19	17	50
1205-2502S	0-250mm/0-10"	±0.03mm	364	27.5	22	20	64
1205-3002S	0-300mm/0-12"	±0.03mm	414	27.5	22	20	64

Graduation 0.02mm (mm)

Code	Range	Accuracy	L	a	b	c	d
1205-1501S	0-150mm	±0.03mm	235	20.5	15.5	16	40
1205-2001S	0-200mm	±0.03mm	290	23.5	19	17	50
1205-2501S	0-250mm	±0.03mm	350	26	21.5	16	60
1205-3001S	0-300mm	±0.03mm	414	27.5	22	20	64

- Meet DIN862
- Made of stainless steel
- Satin chrome plated reading surface

VERNIER CALIPER WITH ROUND DEPTH BAR

- Graduation 0.05mm/1/128"
- Round depth bar
- Meet DIN862
- Made of stainless steel
- Satin chrome plated reading surface



1202-150

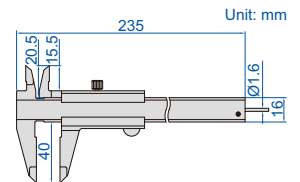

Code	Range	Accuracy
1202-150	0-150mm/0-6"	±0.05mm

VERNIER CALIPERS WITH FINE ADJUSTMENT

- Graduation 0.02mm/0.001"
- With fine adjustment
- Meet DIN862
- Made of stainless steel
- Satin chrome plated reading surface



1233-130

(mm)

Code	Range	Accuracy	L	a	b	c	d
1233-130	0-130mm/0-5"	±0.03mm	230	20.5	16.5	16	40
1233-180	0-180mm/0-7"	±0.03mm	295	23.5	19	16	50
1233-280	0-280mm/0-11"	±0.03mm	410	26	20	20	60

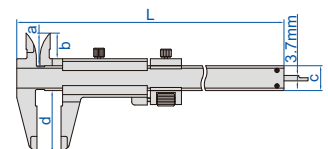

VERNIER CALIPERS WITH THUMB CLAMP

- Meet DIN862
- With thumb clamp
- Made of stainless steel
- Satin chrome plated reading surface

Graduation 0.05mm/1/128" (mm)

Code	Range	Accuracy	L	a	b	c	d
1223-150	0-150mm/0-6"	±0.05mm	230	20.5	16.5	16	40
1223-200	0-200mm/0-8"	±0.05mm	295	23.5	19	16	50

Graduation 0.02mm/0.001" (mm)

Code	Range	Accuracy	L	a	b	c	d
1223-1502	0-150mm/0-6"	±0.03mm	230	20.5	16.5	16	40
1223-2002	0-200mm/0-8"	±0.03mm	295	23.5	19	16	50



1223-150

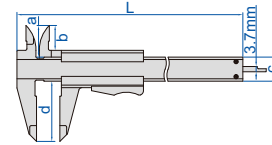

VERNIER CALIPERS WITH CARBIDE TIPPED JAWS

- Carbide tipped jaws for inside and outside measurements
- Meet DIN862
- Made of stainless steel
- Satin chrome plated reading surface

Graduation 0.05mm/1/128" (mm)

Code	Range	Accuracy	L	a	b	c	d
1238-150	0-150mm/0-6"	±0.05mm	230	21	16.5	16	40
1238-200	0-200mm/0-8"	±0.05mm	295	24	19	16	50
1238-300	0-300mm/0-12"	±0.05mm	410	25	20	16	60

Graduation 0.02mm/0.001" (mm)

Code	Range	Accuracy	L	a	b	c	d
1238-1502	0-150mm/0-6"	±0.03mm	230	21	16.5	16	40
1238-2002	0-200mm/0-8"	±0.03mm	295	24	19	16	50
1238-3002	0-300mm/0-12"	±0.03mm	410	25	20	16	60

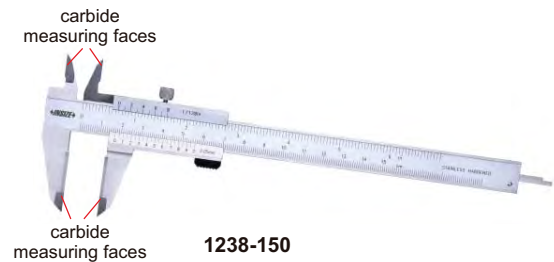

1238-150

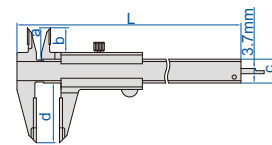

VERNIER CALIPERS



1217-3001

- With fine adjustment
- Made of stainless steel
- Satin chrome plated reading surface

Code	Range	Graduation	Accuracy	L
1217-2503	0-250mm	0.05mm	±0.05mm	360mm
1217-3001	0-300mm	0.02mm	±0.03mm	410mm

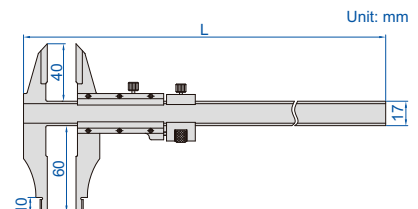
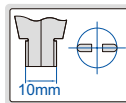

ATTENTION:
NOT HARDENED

PURE COPPER

VERNIER CALIPERS (ANTI MAGNETIC)

2

- Suitable for magnetic parts
- Made of pure copper



1224-150A

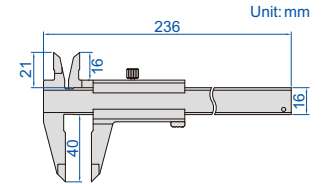

Code	Range	Graduation	Accuracy
1224-150A	0-150mm	0.02mm	±0.05mm
1224-1501A	0-150mm	0.05mm	±0.05mm

LEFT HAND VERNIER CALIPERS

- Designed for left handed users
- Made of stainless steel
- Satin chrome plated reading surface

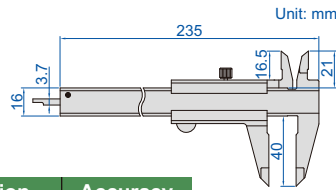

1239-1502

Code	Range	Graduation	Accuracy
1239-150	0-150mm/0-6"	0.05mm/1/128"	±0.05mm
1239-1503	0-150mm	0.05mm	±0.05mm
1239-1502	0-150mm/0-6"	0.02mm/0.001"	±0.03mm
1239-1501	0-150mm	0.02mm	±0.03mm

TEETH VERNIER CALIPER

- Used for teeth
- Made of stainless steel



1226-70

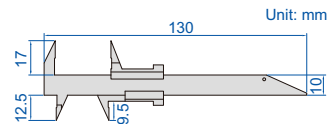

Code	Range	Graduation	Accuracy
1226-70	0-70mm	0.1mm	±0.1mm

DEPTH BASE ATTACHMENTS

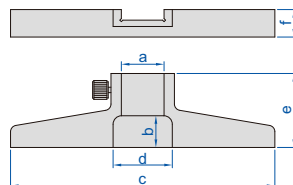

6140



6140-16B

- To increase the stability of depth measurement
- Suitable for digital calipers and dial calipers
- Made of stainless steel

(mm)

Code	a	b	c	d	e	f	Type	Application
6140	16.5	9	75	18	30	6	narrow base (f=6)	suitable for calipers with beam width (w) 16mm
6140-300A	20	15	125	22	34	9	narrow base (f=9)	suitable for calipers with beam width (w) 20mm
6140-16B	16	12.5	75	24.5	30	11	wide base (f=11), high stability	suitable for calipers with beam width (w) 16mm
6140-300B	20	15	125	28	35	13	wide base (f=13), high stability	suitable for calipers with beam width (w) 20mm

CALIPER INSPECTION GAGE BLOCK AND RING GAGE SETS

REFER TO PAGE 290 FOR DETAILS



4176-30

CALIPER/HEIGHT GAGE CHECKERS

REFER TO PAGE 296 FOR DETAILS

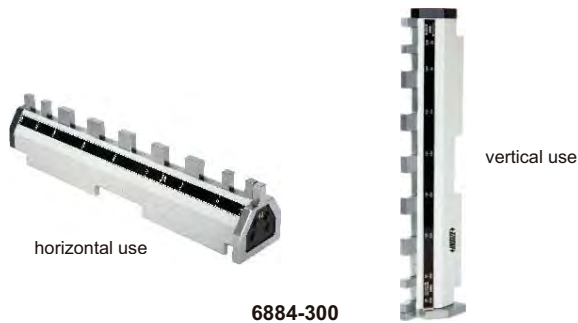

6884-300

CALIPER END GRINDING MACHINE CODE 6309



- Used for grinding the depth measuring surface of the end of calipers

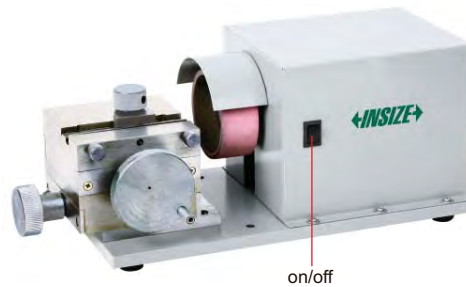

application



SPECIFICATION

Power supply	220V, 50/60Hz
Dimension (L×W×H)	370×200×160mm
Weight	15kg

CALIPER/MICROMETER LAPPING MACHINE CODE 6318

REFER TO PAGE 152 FOR DETAILS

- For lapping measuring surfaces of caliper lower jaws



lapping measuring surfaces of caliper lower jaws



**ACCESSORY SET FOR DIGITAL CALIPERS
CODE 6144**

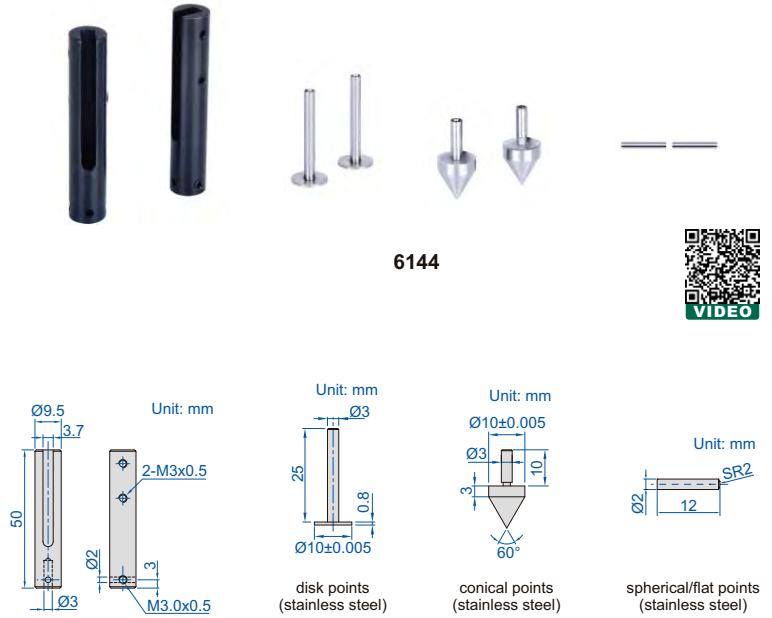
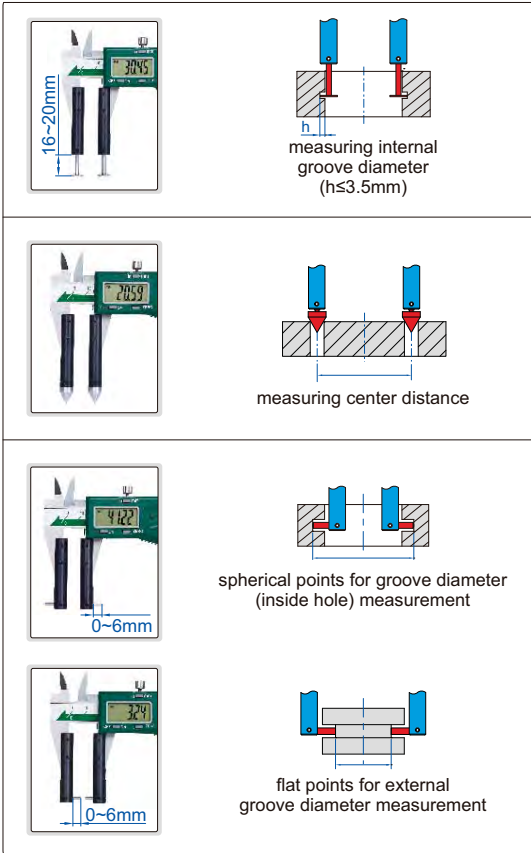

6144



- Suitable for 0-150mm/0-6" and 0-200mm/0-8" digital calipers (thickness of lower jaws ≤ 3.7mm)

Code
6144

**ACCESSORY SET FOR LARGE DIGITAL CALIPERS
CODE 6145-500**

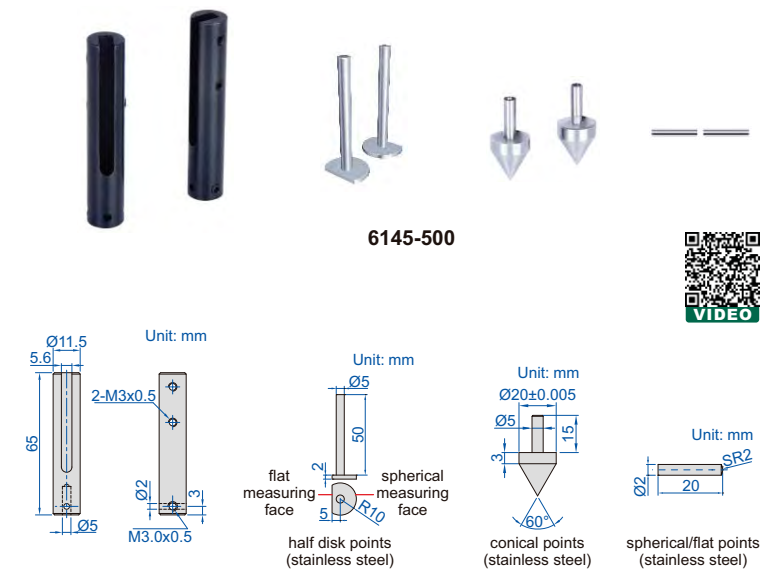
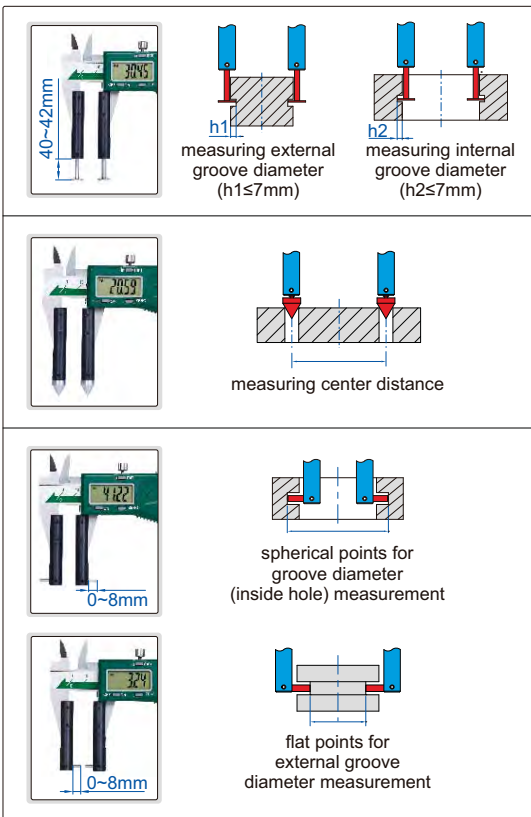

6145-500



- Suitable for 0-500mm/0-20" and 0-600mm/0-24" digital calipers (thickness of lower jaws ≤ 5.6mm)

Code
6145-500

ACCESSORY SET FOR LARGE DIGITAL CALIPERS (WITH SIDE POINTS) CODE 6146-500B



6146-500B

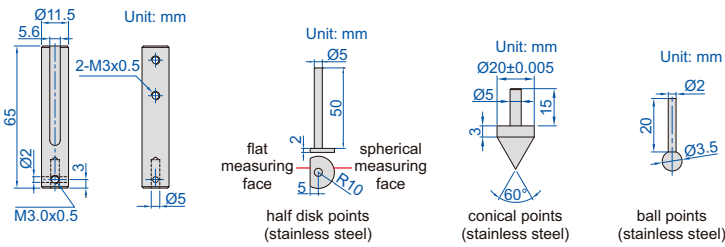

■ Suitable for 0-500mm/0-20" and 0-600mm/0-24" digital calipers (thickness of lower jaws≤5.6mm)

Code
6146-500B

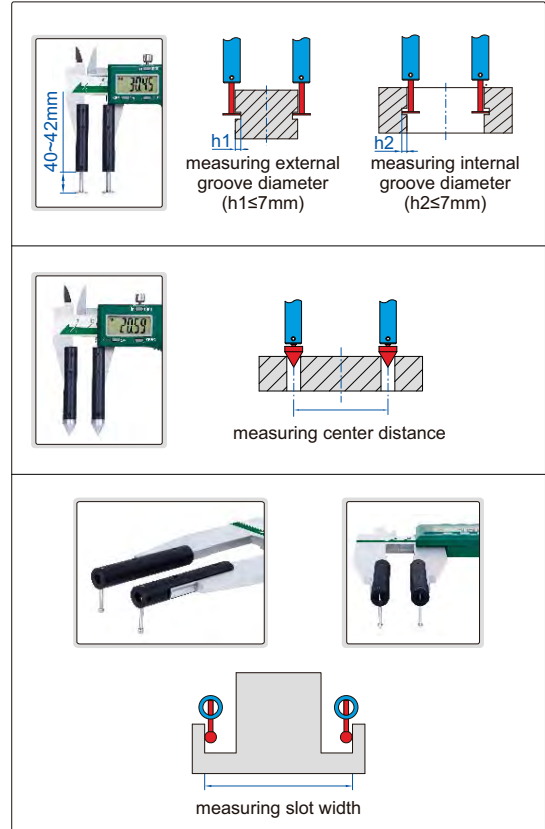

IP65 WATERPROOF DIGITAL CALIPERS

IP65 WATERPROOF **DATA OUTPUT**

- IP65 dust/waterproof
- Resolution: 0.01mm/0.0005"
- Button function: on/off, zero, mm/inch, ABS, data preset
- Battery CR2032
- Automatic power off
- Made of stainless steel



1173-601

With data interface (data output cable code 7302-1104, wireless transmitter code 7315-1104, optional)

Code	Range	Accuracy
1173-601	0-600mm/0-24"	±0.05mm

Built in bluetooth

Code	Range	Accuracy
1173-601WL	0-600mm/0-24"	±0.05mm

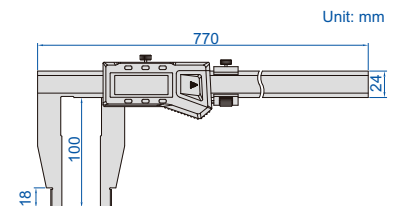
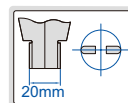

DATA
OUTPUT

POPULAR
MODEL

DIGITAL CALIPERS

2



1106-501

- Non waterproof
- Resolution: 0.01mm/0.0005"
- Button function: on/off, zero, mm/inch, ABS, data preset
- Battery CR2032
- Made of stainless steel

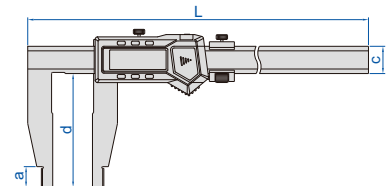
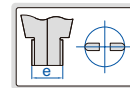

With data interface

Code	Range	Accuracy	a	c	d	e	L	Data output cable (optional)
1106-301	0-300mm/0-12"	±0.05mm	18mm	24mm	100mm	20mm	420mm	7315-22 page 4, 7302-22 page 12
1106-302	0-300mm/0-12"	±0.05mm	18mm	24mm	150mm	20mm	420mm	7315-22 page 4, 7302-22 page 12
1106-451	0-450mm/0-18"	±0.05mm	18mm	24mm	100mm	20mm	625mm	7315-22 page 4, 7302-22 page 12
1106-501	0-500mm/0-20"	±0.05mm	18mm	24mm	100mm	20mm	675mm	7315-22 page 4, 7302-22 page 12
1106-502	0-500mm/0-20"	±0.06mm	18mm	24mm	150mm	20mm	675mm	7315-22 page 4, 7302-22 page 12
1106-503	0-500mm/0-20"	±0.06mm	24mm	31mm	200mm	20mm	675mm	7315-22 page 4, 7302-22 page 12
1106-505	0-500mm/0-20"	±0.08mm	24mm	42mm	300mm	20mm	675mm	7315-22 page 4, 7302-22 page 12
1106-601	0-600mm/0-24"	±0.05mm	18mm	24mm	100mm	20mm	770mm	7315-22 page 4, 7302-22 page 12
1106-602	0-600mm/0-24"	±0.06mm	18mm	24mm	150mm	20mm	770mm	7315-22 page 4, 7302-22 page 12
1106-603	0-600mm/0-24"	±0.06mm	24mm	31mm	200mm	20mm	770mm	7315-22 page 4, 7302-22 page 12
1106-802	0-800mm/0-32"	±0.07mm	24mm	31mm	150mm	20mm	1025mm	7315-22 page 4, 7302-22 page 12
1106-1002	0-1000mm/0-40"	±0.08mm	24mm	31mm	150mm	20mm	1220mm	7315-22 page 4, 7302-22 page 12
1106-1003	0-1000mm/0-40"	±0.08mm	24mm	31mm	200mm	20mm	1220mm	7315-22 page 4, 7302-22 page 12
1106-1005	0-1000mm/0-40"	±0.10mm	24mm	42mm	300mm	20mm	1220mm	7315-20B, 7302-SPC1A
1106-1502	0-1500mm/0-60"	±0.11mm	24mm	42mm	150mm	20mm	1780mm	7315-20B, 7302-SPC1A
1106-1503	0-1500mm/0-60"	±0.12mm	24mm	42mm	200mm	20mm	1780mm	7315-20B, 7302-SPC1A
1106-2002	0-2000mm/0-80"	±0.14mm	24mm	42mm	150mm	20mm	2290mm	7315-20B, 7302-SPC1A
1106-2003	0-2000mm/0-80"	±0.14mm	24mm	42mm	200mm	20mm	2290mm	7315-20B, 7302-SPC1A
1106-2502	0-2500mm/0-100"	±0.22mm	24mm	42mm	150mm	20mm	2800mm	7315-20B, 7302-SPC1A
1106-3002	0-3000mm/0-120"	±0.26mm	24mm	42mm	150mm	20mm	3300mm	7315-20B, 7302-SPC1A

Built-in wireless (receiver code 7315-2/3/6/7/8/9 is required)

Code	Range	Accuracy	a	c	d	e	L
1106-301WL	0-300mm/0-12"	±0.05mm	18mm	24mm	100mm	20mm	420mm
1106-302WL	0-300mm/0-12"	±0.05mm	18mm	24mm	150mm	20mm	420mm
1106-451WL	0-450mm/0-18"	±0.05mm	18mm	24mm	100mm	20mm	625mm
1106-501WL	0-500mm/0-20"	±0.05mm	18mm	24mm	100mm	20mm	675mm
1106-502WL	0-500mm/0-20"	±0.06mm	18mm	24mm	150mm	20mm	675mm
1106-601WL	0-600mm/0-24"	±0.05mm	18mm	24mm	100mm	20mm	770mm
1106-602WL	0-600mm/0-24"	±0.06mm	18mm	24mm	150mm	20mm	770mm

DIGITAL CALIPERS

DATA OUTPUT

- Non waterproof
- Resolution: 0.01mm/0.0005"
- Button function: on/off, zero, mm/inch, ABS, data preset
- Battery CR2032
- Made of stainless steel



1117-501

With data interface (data output cable code 7315-22 page 4, 7302-22 page 12, optional)

Code	Range	Accuracy	a	b	c	d	e	L
1117-301	0-300mm/0-12"	±0.05mm	18mm	56mm	24mm	100mm	20mm	420mm
1117-501	0-500mm/0-20"	±0.05mm	18mm	56mm	24mm	100mm	20mm	675mm
1117-502	0-500mm/0-20"	±0.06mm	24mm	56mm	24mm	150mm	20mm	675mm
1117-601	0-600mm/0-24"	±0.05mm	18mm	56mm	24mm	100mm	20mm	770mm
1117-802	0-800mm/0-32"	±0.07mm	24mm	67mm	31mm	150mm	20mm	1025mm
1117-1002	0-1000mm/0-40"	±0.08mm	24mm	67mm	31mm	150mm	20mm	1220mm

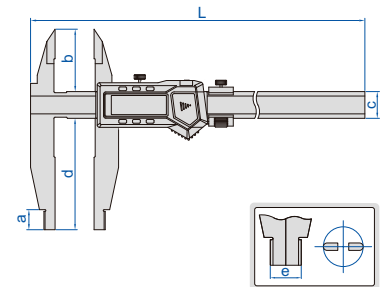

Built-in wireless (receiver code 7315-2/3/6/7/8/9 is required)

Code	Range	Accuracy	a	b	c	d	e	L
1117-301WL	0-300mm/0-12"	±0.05mm	18mm	56mm	24mm	100mm	20mm	420mm
1117-501WL	0-500mm/0-20"	±0.05mm	18mm	56mm	24mm	100mm	20mm	675mm
1117-502WL	0-500mm/0-20"	±0.06mm	24mm	56mm	24mm	150mm	20mm	675mm
1117-601WL	0-600mm/0-24"	±0.05mm	18mm	56mm	24mm	100mm	20mm	770mm

DIGITAL CALIPERS

DATA OUTPUT

- Non waterproof
- Resolution: 0.01mm/0.0005"
- Button function: on/off, zero, mm/inch, ABS, data preset
- Battery CR2032
- Made of stainless steel



1136-501

With data interface
(data output cable code 7315-22 page 4, 7302-22 page 12, optional, for calipers with c=24mm or 31mm) (mm)

Code	Range	Accuracy	a	b	c	d	L
1136-301	0-300mm/0-12"	±0.05mm	18	45	24	100	420
1136-451	0-450mm/0-18"	±0.05mm	18	45	24	100	625
1136-501	0-500mm/0-20"	±0.05mm	18	45	24	100	675
1136-502	0-500mm/0-20"	±0.06mm	18	45	24	150	675
1136-503	0-500mm/0-20"	±0.06mm	24	60	31	200	675
1136-601	0-600mm/0-24"	±0.05mm	18	45	24	100	770
1136-1002	0-1000mm/0-40"	±0.08mm	24	60	31	150	1220
1136-1502	0-1500mm/0-60"	±0.11mm	24	60	42	150	1780
1136-2002	0-2000mm/0-80"	±0.14mm	24	60	42	150	2290

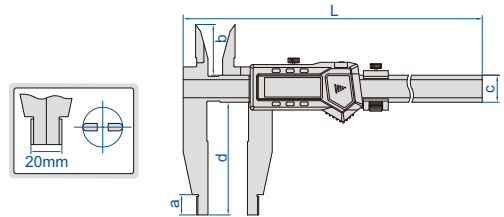

Built-in wireless
(receiver code 7315-2/3/6/7/8/9 is required) (mm)

Code	Range	Accuracy	a	b	c	d	L
1136-301WL	0-300mm/0-12"	±0.05mm	18	45	24	100	420
1136-451WL	0-450mm/0-18"	±0.05mm	18	45	24	100	625
1136-501WL	0-500mm/0-20"	±0.05mm	18	45	24	100	675
1136-502WL	0-500mm/0-20"	±0.06mm	18	45	24	150	675
1136-601WL	0-600mm/0-24"	±0.05mm	18	45	24	100	770

DATA OUTPUT

DIGITAL CALIPERS



1135-601

- Non waterproof
- Resolution: 0.01mm/0.0005"
- Button function: on/off, zero, mm/inch, ABS, data preset
- Battery CR2032
- Made of stainless steel

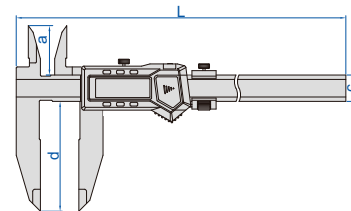

With data interface (data output cable code 7315-22 page 4, 7302-22 page 12, optional) (mm)

Code	Range	Accuracy	a	c	d	L
1135-451	0-450mm/0-18"	±0.05mm	45	24	100	625
1135-601	0-600mm/0-24"	±0.05mm	45	24	100	770
1135-1002	0-1000mm/0-40"	±0.08mm	60	31	150	1220

Built-in wireless (receiver code 7315-2/3/6/7/8/9 is required) (mm)

Code	Range	Accuracy	a	c	d	L
1135-451WL	0-450mm/0-18"	±0.05mm	45	24	100	625
1135-601WL	0-600mm/0-24"	±0.05mm	45	24	100	770

VERNIER CALIPERS (SOLID TYPE)

- With fine adjustment
- Made of stainless steel
- Satin chrome plated reading surface



1236-521

solid type (without screw)

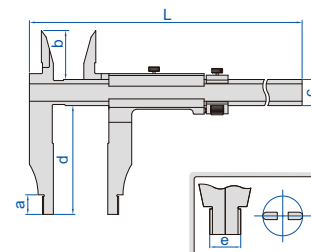

Graduation 0.05mm/1/128" (mm)

Code	Range	Accuracy	a	b	c	d	e	L
1236-394	0-300mm/0-12"	±0.07mm	12	38	20	90	10	450
1236-514	0-500mm/0-20"	±0.07mm	18	45	24	100	20	670
1236-524	0-500mm/0-20"	±0.08mm	18	45	24	150	20	670
1236-614	0-600mm/0-24"	±0.08mm	18	45	24	100	20	770
1236-824	0-800mm/0-32"	±0.09mm	24	60	31	150	20	1030
1236-1024	0-1000mm/0-40"	±0.12mm	24	60	31	150	20	1230

Graduation 0.02mm (mm)

Code	Range	Accuracy	a	b	c	d	e	L
1236-511	0-500mm	±0.05mm	18	45	24	100	20	670
1236-521	0-500mm	±0.06mm	18	45	24	150	20	670
1236-1021	0-1000mm	±0.08mm	24	60	31	150	20	1230

VERNIER CALIPERS (SOLID TYPE)

- Graduation 0.05mm/1/128"
- With fine adjustment
- Made of stainless steel
- Satin chrome plated reading surface



1207-514

(mm)

solid type (without screw)

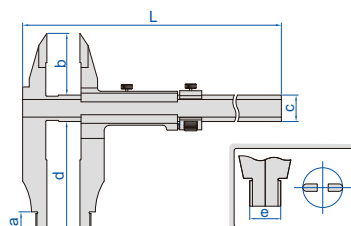

Code	Range	Accuracy	a	b	c	d	e	L
1207-394	0-300mm/0-12"	±0.07mm	12	40	20	90	10	440
1207-514	0-500mm/0-20"	±0.07mm	18	56	24	100	20	670
1207-524	0-500mm/0-20"	±0.08mm	18	56	24	150	20	670
1207-824	0-800mm/0-32"	±0.09mm	24	67	31	150	20	930
1207-1024	0-1000mm/0-40"	±0.12mm	24	67	31	150	20	1230

VERNIER CALIPERS (SOLID TYPE)

- With fine adjustment
- Made of stainless steel
- Satin chrome plated reading surface



1208-511

Graduation 0.05mm/1/128" (mm)

Code	Range	Accuracy	a	c	d	e	L
1208-214	0-200mm/0-8"	±0.06mm	10	20	100	10	330
1208-394	0-300mm/0-12"	±0.07mm	10	20	90	10	410
1208-324	0-300mm/0-12"	±0.07mm	18	24	150	20	410
1208-524	0-500mm/0-20"	±0.08mm	18	24	150	20	670
1208-614	0-600mm/0-24"	±0.08mm	18	24	100	20	770
1208-624	0-600mm/0-24"	±0.09mm	18	24	150	20	770
1208-824	0-800mm/0-32"	±0.09mm	24	31	150	20	1030
1208-1024	0-1000mm/0-40"	±0.12mm	24	31	150	20	1230
1208-1524	0-1500mm/0-60"	±0.16mm	24	42	150	20	1820
1208-2024	0-2000mm/0-80"	±0.20mm	24	42	150	20	2330

solid type
(without screw)



Graduation 0.02mm (mm)

Code	Range	Accuracy	a	c	d	e	L
1208-511	0-500mm	±0.05mm	18	24	100	20	670
1208-521	0-500mm	±0.06mm	18	24	150	20	670
1208-1021	0-1000mm	±0.08mm	24	31	150	20	1230
1208-1521	0-1500mm	±0.11mm	24	42	150	20	1820

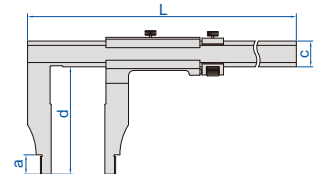
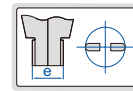

VERNIER CALIPERS (SOLID TYPE)

- With fine adjustment
- Made of stainless steel
- Satin chrome plated reading surface



1210-611

Graduation 0.05mm/1/128" (mm)

Code	Range	Accuracy	a	c	d	L
1210-614	0-600mm/0-24"	±0.08mm	45	24	100	770
1210-1024	0-1000mm/0-40"	±0.12mm	60	31	150	1230

Graduation 0.02mm (mm)

Code	Range	Accuracy	a	c	d	L
1210-611	0-600mm	±0.05mm	45	24	100	770
1210-1021	0-1000mm	±0.08mm	60	31	150	1230

solid type
(without screw)

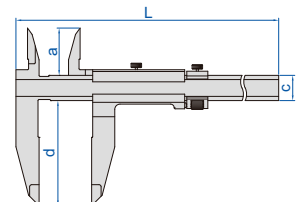

POPULAR MODEL

VERNIER CALIPERS (SEPARATE TYPE)

2

- With fine adjustment
- Made of stainless steel
- Satin chrome plated reading surface



1214-500

Graduation 0.02mm/0.001"

(mm)

Code	Range	Accuracy	a	c	d	e	L
1214-300	0-300mm/0-12"	±0.05mm	10	20	75	10	410
1214-450	0-450mm/0-18"	±0.05mm	18	24	100	20	620
1214-500	0-500mm/0-20"	±0.05mm	18	24	100	20	670
1214-600	0-600mm/0-24"	±0.05mm	18	24	100	20	770
1214-1000	0-1000mm/0-40"	±0.08mm	24	32	140	20	1216
1214-1500	0-1500mm/0-60"	±0.12mm	24	42	200	20	1830
1214-2000	0-2000mm/0-80"	±0.14mm	24	42	200	20	2320

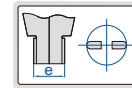
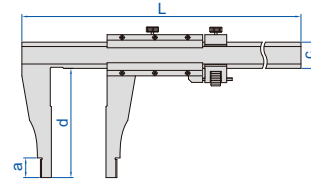

separate type
(with screws)



Graduation 0.05mm/1/128"

(mm)

Code	Range	Accuracy	a	c	d	e	L
1214-6004	0-600mm/0-24"	±0.08mm	18	24	100	20	770
1214-1004	0-1000mm/0-40"	±0.12mm	24	32	140	20	1216

LONG JAW VERNIER CALIPERS (SEPARATE TYPE)

- With fine adjustment
- Made of stainless steel
- Satin chrome plated reading surface



1215-1032

Graduation 0.02mm/0.001"

(mm)

Code	Range	Accuracy	a	c	d	e	L
1215-392	0-300mm/0-12"	±0.05mm	10	17	90	10	410
1215-322	0-300mm/0-12"	±0.05mm	18	24	150	20	470
1215-522	0-500mm/0-20"	±0.06mm	18	24	150	20	670
1215-532	0-500mm/0-20"	±0.06mm	18	24	200	20	670
1215-622	0-600mm/0-24"	±0.06mm	18	24	150	20	770
1215-642	0-600mm/0-24"	±0.08mm	24	32	250	20	870
1215-822	0-800mm/0-32"	±0.07mm	24	32	150	20	1020
1215-832	0-800mm/0-32"	±0.07mm	24	32	200	20	1020
1215-1032	0-1000mm/0-40"	±0.08mm	24	32	200	20	1220
1215-1052	0-1000mm/0-40"	±0.11mm	24	42	300	20	1330
1215-3052	0-3000mm/0-120"	±0.26mm	24	50	300	20	3360

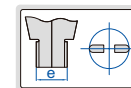
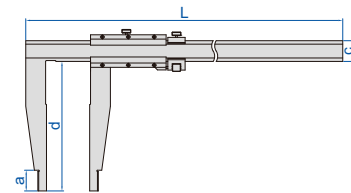

separate type
(with screws)



Graduation 0.05mm/1/128"

(mm)

Code	Range	Accuracy	a	c	d	e	L
1215-524	0-500mm/0-20"	±0.08mm	18	24	150	20	670
1215-1034	0-1000mm/0-40"	±0.12mm	24	32	200	20	1330

UNIVERSAL CALIPERS

DATA
OUTPUT



1125-600

- Non waterproof
- Buttons: on/off, set, mm/inch, ABS, preset (+, -)
- Automatic power off, move the digital unit to turn on power
- Battery CR2032
- Made of stainless steel

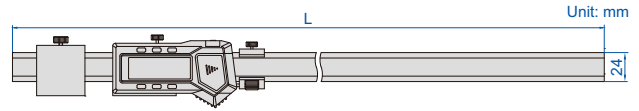

With data interface
(data output cable code 7315-22 page 4, 7302-22 page 12, optional)

Code	Range *	Resolution	Accuracy	L
1125-600	0-600mm/0-24"	0.01mm/0.0005"	±0.05mm	778mm
1125-1000	0-1000mm/0-40"	0.01mm/0.0005"	±0.07mm	1205mm

Built-in wireless (receiver code 7315-2/3/6/7/8/9 is required)

Code	Range *	Resolution	Accuracy	L
1125-600WL	0-600mm/0-24"	0.01mm/0.0005"	±0.05mm	778mm
1125-1000WL	0-1000mm/0-40"	0.01mm/0.0005"	±0.07mm	1205mm

*The range changes according to different points

working with stands

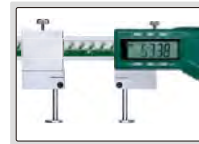

working with measuring jaws

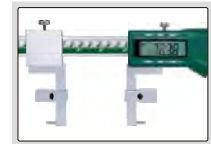

Half disk points (included)

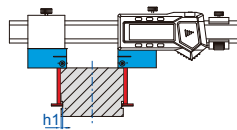
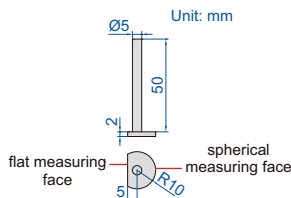

measuring external groove diameter with flat measuring face (depth $h1 \leq 2.5\text{mm}$)

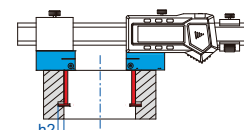

measuring internal groove diameter with spherical measuring face (depth $h2 \leq 2.5\text{mm}$)

Conical points (optional)

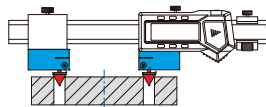
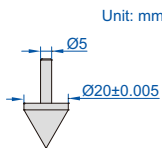

measuring center distance

Round shoulder points (optional)

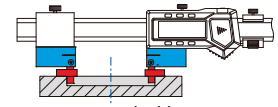
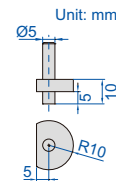

measure inside diameter of shallow hole

Flat shoulder points (optional)

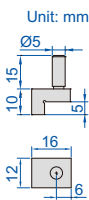

measure outside diameter of low boss

Spherical points (included)

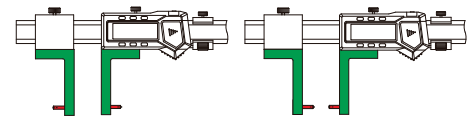
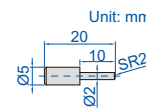

Point sleeve (optional)

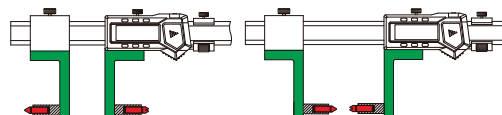
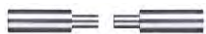

working with multifunctional points, ball points and screw thread points

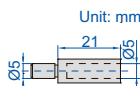

Code
1125-T104

Stands (included)

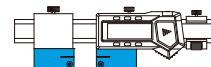
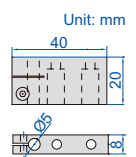

To be continued

Continued from previous page

Depth stop (included)

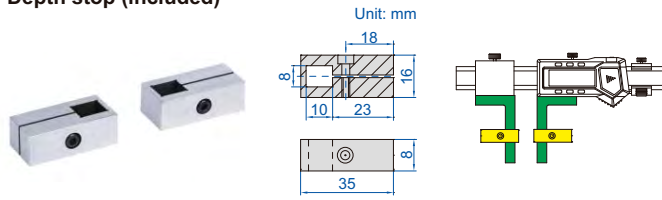

Measuring jaws (included)

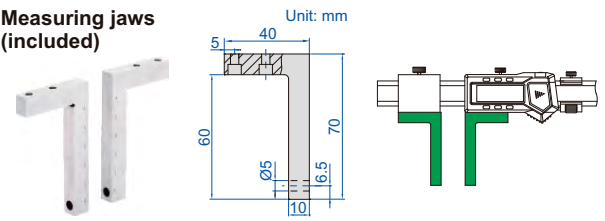

Multifunctional points 7392* (optional, page 40)



* It is necessary to use point sleeve (code 1125-T104) for these points

Ball points 7391* (optional, page 40)



Screw thread points 7381*, 7321* (optional, page 40)



DATA OUTPUT

DIGITAL CALIPERS WITH INTERCHANGEABLE POINTS



1526-200

- Non waterproof
- Supplied with 3 pairs of points and zero setting block for external measurement
- Resolution: 0.01mm/0.0005"
- Buttons: on/off, set, mm/inch, preset (+, -)
- Automatic power off, move the digital unit to turn on power
- Battery CR2032
- Made of stainless steel
- Optional accessory: points

preset buttons

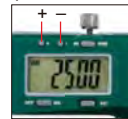

short spherical points (included) Unit: mm



long spherical/flat points (included) Unit: mm



spherical blade points (included) Unit: mm

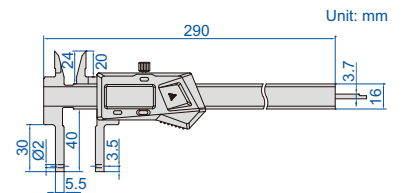

With data interface

Code	Data output cable (optional)
1526-200	code 7315-21 page 4, 7302-21 page 12

Built-in wireless

Code	Receiver (optional)
1526-200WL	code 7315-2/3/6/7/8/9

Point	Range	Accuracy	Application
short spherical points	12-212mm/0.5-8.5" (internal)	±0.03mm	for grooves inside small hole
long spherical/flat points	24-224mm/1-8.8" (internal) 0-187mm/0-7.5" (external)	±0.03mm	spherical points for grooves inside hole flat points for external grooves
spherical blade points	24-224mm/1-8.8" (internal) 0-187mm/0-7.5" (external)	±0.03mm	for narrow grooves inside hole



zero setting block for external measurement (included)



install points

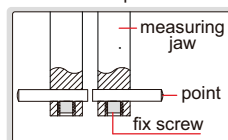

measure internal and external grooves

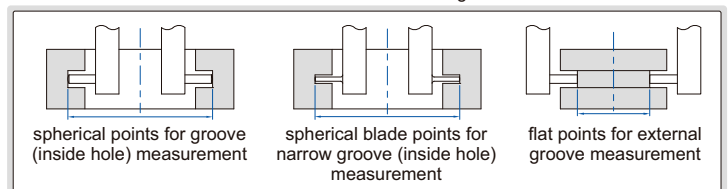

To be continued

Continued from previous page

2

Depth step (optional)

Code
6143

6143

for external groove measurement for internal groove measurement

Point sleeve (optional)

1526-T101

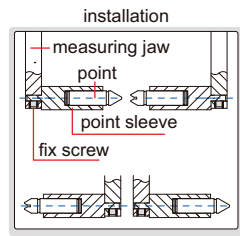

Code
1526-T101

Ball points (optional)

7391-T5

7391-T6

* It is necessary to use point sleeve (code **1526-T101**) for these points
** Range of **1526-200** and **1526-200WL** after installing the points and point sleeve

Code	Ball dia. (D)	Range **
7391-T3 *	SØ2.0mm	75-275mm/3.0-10.8" (internal) 0-146mm/0-5.7" (external)
7391-T4 *	SØ2.5mm	76-276mm/3.0-10.8" (internal) 0-145mm/0-5.7" (external)
7391-T5 *	SØ3.0mm	77-277mm/3.0-10.9" (internal) 0-144mm/0-5.6" (external)
7391-T6 *	SØ3.5mm	78-278mm/3.1-10.9" (internal) 0-143mm/0-5.6" (external)
7391-T7 *	SØ4.0mm	79-279mm/3.1-10.9" (internal) 0-142mm/0-5.6" (external)
7391-T8 *	SØ4.5mm	80-280mm/3.2-11.0" (internal) 0-141mm/0-5.5" (external)
7391-T9 *	SØ5.0mm	81-281mm/3.2-11.0" (internal) 0-140mm/0-5.5" (external)
7391-T10 *	SØ6.0mm	83-283mm/3.3-11.1" (internal) 0-138mm/0-5.4" (external)

Multifunctional points (optional)

7392-T1 **7392-T4** **7392-T7**

7392-T2 **7392-T5** **7392-T8**

7392-T3 **7392-T6** **7392-T9**

Code	Type
7392-T1 *	flat
7392-T2 *	spherical
7392-T3 *	spline
7392-T4 *	disk
7392-T5 *	blade
7392-T6 *	knife-edge point
7392-T7 *	point
7392-T8 *	knife-edge point
7392-T9 *	point

Range **
66-266mm/2.6-10.5" (internal), 0-155mm/0-6.1" (external)

** Range of **1526-200** and **1526-200WL** after installing the points and point sleeve

* It is necessary to use point sleeve (code **1526-T101**) for these points

Screw thread points (optional)

7321-T16 **7381-T11**

Internal thread (60° thread angle)

Code	Pitch
7321-T11 *	0.4-0.5mm/64-48TPI
7321-T12 *	0.6-0.9mm/44-28TPI
7321-T13 *	1-1.75mm/24-14TPI
7321-T14 *	2-3mm/13-9TPI
7321-T15 *	3.5-5mm/8-5TPI
7321-T16 *	5.5-7mm/4.5-3.5TPI
7321-T1S *	6 pairs/set, including all above points

External thread (60° thread angle)

Code	Pitch
7381-T11 *	0.4-0.5mm/64-48TPI
7381-T12 *	0.6-0.9mm/44-28TPI
7381-T13 *	1-1.75mm/24-14TPI
7381-T14 *	2-3mm/13-9TPI
7381-T15 *	3.5-5mm/8-5TPI
7381-T16 *	5.5-7mm/4.5-3.5TPI
7381-TS *	6 pairs/set, including all above points

Range **
66-266mm/2.6-10.5" (internal)
0-155mm/0-6.1" (external)

** Range of **1526-200** and **1526-200WL** after installing the points and point sleeve

* It is necessary to use point sleeve (code **1526-T101**) for these points



DATA OUTPUT

DIGITAL CALIPERS WITH INTERCHANGEABLE POINTS

short spherical/flat points (included) Unit: mm

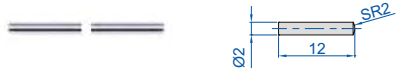

long spherical/flat points (included) Unit: mm



short spherical blade points (included) Unit: mm

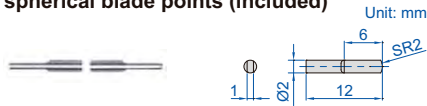

long spherical blade points (included) Unit: mm

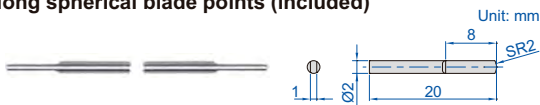

1124-300A

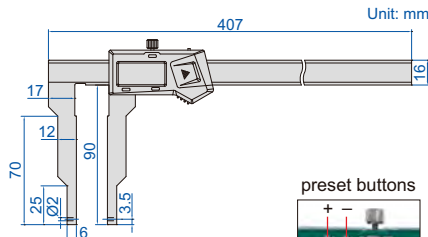

zero setting block for external measurement (included)



measure internal and external grooves

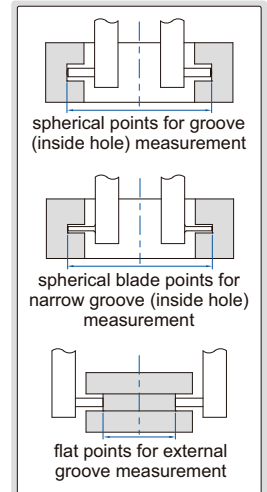

- Non waterproof
- Supplied with 4 pairs of points and zero setting block for external measurement
- Resolution: 0.01mm/0.0005"
- Buttons: on/off, set, mm/inch, preset (+, -)
- Automatic power off, move the digital unit to turn on power
- Battery CR2032
- Made of stainless steel
- Optional accessory: points (code 1526-T101, 7392, 7391, 7381, 7321), depth stop (code 6143)

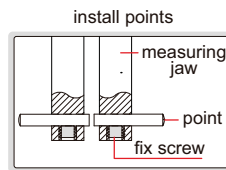

With data interface

Code	Data output cable (optional)
1124-300A	code 7315-21 page 4, 7302-21 page 12

Built-in wireless

Code	Receiver (optional)
1124-300AWL	code 7315-2/3/6/7/8/9

Point	Range	Accuracy	Application
short spherical/flat points	24-324mm/1-12.7" (internal) 0-288mm/0-11.3" (external)	±0.04mm	spherical points for grooves inside hole (small hole) flat points for external grooves
long spherical/flat points	40-340mm/1.5-13.3" (internal) 0-272mm/0-10.7" (external)	±0.04mm	spherical points for grooves inside hole (large hole) flat points for external grooves
short spherical blade points	24-324mm/1-12.7" (internal) 0-288mm/0-11.3" (external)	±0.04mm	for narrow grooves inside hole (small hole)
long spherical blade points	40-340mm/1.5-13.3" (internal) 0-272mm/0-10.7" (external)	±0.04mm	for narrow grooves inside hole (large hole)

Multifunctional points 7392* (optional, page 40)



Ball points 7391* (optional, page 40)



Screw thread points 7381*, 7321* (optional, page 40)

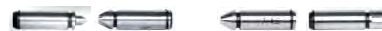

* It is necessary to use point sleeve (code 1526-T101) for these points

DIGITAL CALIPERS WITH INTERCHANGEABLE POINTS

DATA
OUTPUT

VARIOUS POINTS ARE
AVAILABLE (PAGE 219~221)



1530-300

- Non waterproof
- Supplied with 4 pairs of points and zero setting block for external measurement
- Resolution: 0.01mm/0.0005"
- Buttons: on/off, set, mm/inch, preset (+, -)
- Automatic power off, move the digital unit to turn on power
- Battery CR2032
- Made of stainless steel
- Optional accessory: points (page 219~221), depth stop (code **6143**)

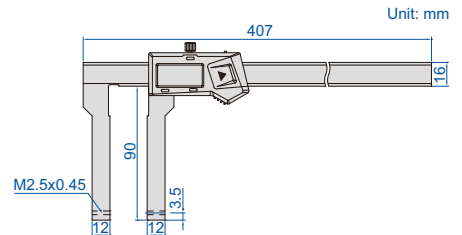
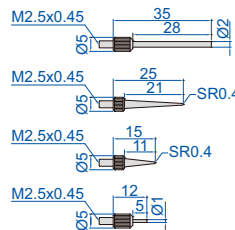

zero setting block for external measurement (included)



depth stop **6143** (optional)



preset buttons



4 pairs of points (included)

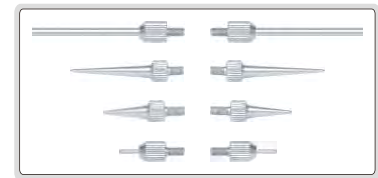

With data interface (data output cable code 7315-21 page 4, 7302-21 page 12, optional)

Code	Range*	Accuracy
1530-300	0-300mm/0-12"	±0.04mm

Built-in wireless (receiver code 7315-2/3/6/7/8/9 is required)

Code	Range*	Accuracy
1530-300WL	0-300mm/0-12"	±0.04mm

*For different points, the measuring range changes accordingly

measure internal and external grooves

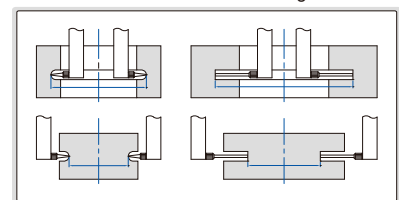

DIGITAL INSIDE GROOVE CALIPERS

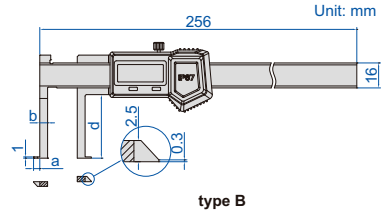
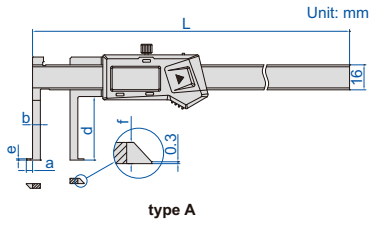

- Measure diameter of grooves inside small bores
- Resolution: 0.01mm/0.0005"
- Buttons type A: on/off, set, mm/inch, preset (+, -), type B: on/off, zero, mm/inch, ABS/REL, hold
- Battery CR2032
- Made of stainless steel
- Optional accessory: depth stop (code 6143)

depth stop 6143 (optional)

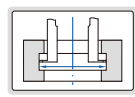

Non waterproof, with data interface (data output cable code 7315-21 page 4, 7302-21 page 12, optional)

Code	Range	Type	Accuracy	L	a	b	d	e	f
1520-150	11-150mm/0.43-6"	A	±0.04mm	236mm	3.5mm	5mm	41mm	1mm	2.5mm
1520-200	16-200mm/0.63-8"	A	±0.04mm	285mm	5mm	7mm	41mm	1mm	3mm
1520-300	20-300mm/0.79-12"	A	±0.05mm	398mm	7.5mm	9mm	62mm	2mm	4mm

Non waterproof, built-in wireless (receiver code 7315-2/3/6/7/8/9 is required)

Code	Range	Type	Accuracy	L	a	b	d	e	f
1520-150WL	11-150mm/0.43-6"	A	±0.04mm	236mm	3.5mm	5mm	41mm	1mm	2.5mm
1520-200WL	16-200mm/0.63-8"	A	±0.04mm	285mm	5mm	7mm	41mm	1mm	3mm
1520-300WL	20-300mm/0.79-12"	A	±0.05mm	398mm	7.5mm	9mm	62mm	2mm	4mm

IP67 dust/waterproof, no automatic power off, set zero after power on each time, without data interface

Code	Range	Type	Accuracy	a	b	d
1520-150P	14-150mm/0.56-6"	B	±0.04mm	5mm	7mm	30mm
1520-1501P	8-150mm/0.31-6"	B	±0.04mm	2mm	4mm	40mm

DIGITAL INSIDE POINT CALIPERS

DATA
OUTPUT

2

depth stop 6143
(optional)



1121-150A
type A



1121-150B
type B

- Non waterproof
- Measure groove diameter
- Resolution: 0.01mm/0.0005"
- Buttons type A: on/off, set, mm/inch, preset (+, -)
type B: on/off, zero, mm/inch
- Automatic power off, move the digital unit to turn on power
- Battery CR2032
- Data output
- Made of stainless steel
- Optional accessory: depth stop
(code 6143, for calipers with c=16mm)

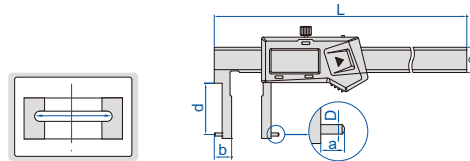

Preset (no need to add the width of the jaws on the reading), with data interface

(mm)

Code	Range	Type	Accuracy	L	a	b	c	d	D	Data output cable (optional)
1121-150A	24-150mm/0.94-6"	A	±0.04mm	250	5	12	16	28	Ø2	7315-21 page 4, 7302-21 page 12
1121-1501	35-150mm/1.38-6"	A	±0.05mm	250	6	17.5	16	60	Ø2	7315-21 page 4, 7302-21 page 12
1121-200A	25-200mm/0.98-8"	A	±0.04mm	310	5	12.5	16	37	Ø2	7315-21 page 4, 7302-21 page 12
1121-2001	40-200mm/1.57-8"	A	±0.05mm	310	7	20	16	70	Ø3	7315-21 page 4, 7302-21 page 12
1121-300A	30-300mm/1.18-12"	A	±0.07mm	410	5	15	16	50	Ø2	7315-21 page 4, 7302-21 page 12
1121-3001A	50-300mm/1.97-12"	A	±0.07mm	410	8	25	16	77	Ø3	7315-21 page 4, 7302-21 page 12
1121-500A	40-500mm/1.57-20"	A	±0.07mm	680	5	20	24	90	Ø3	7315-22 page 4, 7302-22 page 12
1121-5001	60-500mm/2.36-20"	A	±0.08mm	680	10	30	24	120	Ø3	7315-22 page 4, 7302-22 page 12
1121-5002	80-500mm/3.15-20"	A	±0.08mm	680	16	40	24	150	Ø3	7315-22 page 4, 7302-22 page 12

Preset (no need to add the width of the jaws on the reading), built-in wireless (receiver code 7315-2/3/6/7/8/9 is required)

Code	Range	Type	Accuracy	L	a	b	c	d	D
1121-150AWL	24-150mm/0.94-6"	A	±0.04mm	250mm	5mm	12mm	16mm	28mm	Ø2mm
1121-1501WL	35-150mm/1.38-6"	A	±0.05mm	250mm	6mm	17.5mm	16mm	60mm	Ø2mm
1121-200AWL	25-200mm/0.98-8"	A	±0.04mm	310mm	5mm	12.5mm	16mm	37mm	Ø2mm
1121-2001WL	40-200mm/1.57-8"	A	±0.05mm	310mm	7mm	20mm	16mm	70mm	Ø3mm
1121-300AWL	30-300mm/1.18-12"	A	±0.07mm	410mm	5mm	15mm	16mm	50mm	Ø2mm
1121-3001AWL	50-300mm/1.97-12"	A	±0.07mm	410mm	8mm	25mm	16mm	77mm	Ø3mm
1121-500AWL	40-500mm/1.57-20"	A	±0.07mm	680mm	5mm	20mm	24mm	90mm	Ø3mm
1121-5001WL	60-500mm/2.36-20"	A	±0.08mm	680mm	10mm	30mm	24mm	120mm	Ø3mm
1121-5002WL	80-500mm/3.15-20"	A	±0.08mm	680mm	16mm	40mm	24mm	150mm	Ø3mm

No preset (need to add the width of the jaws on the reading)

Code	Range	Type	Accuracy	L	a	b	c	d	D
1121-150B	50-150mm/1.97-6"	B	±0.06mm	270mm	8mm	25mm	20mm	90mm	Ø3mm
1121-200B	60-200mm/2.36-8"	B	±0.06mm	320mm	10mm	30mm	20mm	100mm	Ø3mm
1121-300B	60-300mm/2.36-12"	B	±0.07mm	420mm	10mm	30mm	20mm	110mm	Ø3mm

DIGITAL INSIDE GROOVE CALIPERS

depth stop **6143**
(optional)



- Measure groove diameter
- Resolution: 0.01mm/0.0005"
- Buttons type A: on/off, set, mm/inch, preset (+, -)
type B: on/off, zero, mm/inch
type C: on/off, zero, mm/inch, ABS/REL, hold
- Battery CR2032
- Made of stainless steel
- Optional accessory: depth stop
(code **6143**, for calipers with c=16mm)



1120-150A
type A



1120-150B
type B



1120-150P
type C

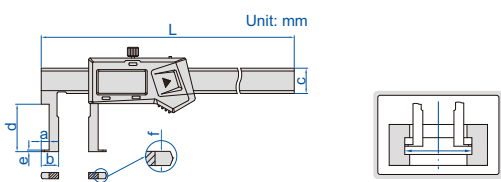

Non waterproof, preset (no need to add the width of the jaws on the reading), with data interface (mm)

Code	Range	Type	Accuracy	L	a	b	c	d	e	f	Data output cable (optional)
1120-150A	22-150mm/0.87-6"	A	±0.04mm	250	5	11	16	30	1	4	7315-21 page 4, 7302-21 page 12
1120-1501	35-150mm/1.38-6"	A	±0.06mm	250	6	17.5	16	60	1.5	4	7315-21 page 4, 7302-21 page 12
1120-200A	25-200mm/0.98-8"	A	±0.04mm	310	5	12.5	16	40	1	4	7315-21 page 4, 7302-21 page 12
1120-2001	40-200mm/1.57-8"	A	±0.06mm	310	7	20	16	70	2.5	4	7315-21 page 4, 7302-21 page 12
1120-300A	30-300mm/1.18-12"	A	±0.05mm	410	5	15	16	50	1.5	4	7315-21 page 4, 7302-21 page 12
1120-3001	50-300mm/1.97-12"	A	±0.07mm	410	8	25	16	80	2.5	4	7315-21 page 4, 7302-21 page 12
1120-500	40-500mm/1.57-20"	A	±0.07mm	680	5	20	24	90	2.2	5.5	7315-22 page 4, 7302-22 page 12
1120-5001	60-500mm/2.36-20"	A	±0.08mm	680	10	30	24	120	3.4	5.5	7315-22 page 4, 7302-22 page 12
1120-5002	80-500mm/3.15-20"	A	±0.08mm	680	16	40	24	150	5.2	5.5	7315-22 page 4, 7302-22 page 12

Non waterproof, preset (no need to add the width of the jaws on the reading), built-in wireless (receiver code 7315-2/3/6/7/8/9 is required)

Code	Range	Type	Accuracy	L	a	b	c	d	e	f
1120-150AWL	22-150mm/0.87-6"	A	±0.04mm	250mm	5mm	11mm	16mm	30mm	1mm	4mm
1120-1501WL	35-150mm/1.38-6"	A	±0.06mm	250mm	6mm	17.5mm	16mm	60mm	1.5mm	4mm
1120-200AWL	25-200mm/0.98-8"	A	±0.04mm	310mm	5mm	12.5mm	16mm	40mm	1mm	4mm
1120-2001WL	40-200mm/1.57-8"	A	±0.06mm	310mm	7mm	20mm	16mm	70mm	2.5mm	4mm
1120-300AWL	30-300mm/1.18-12"	A	±0.05mm	410mm	5mm	15mm	16mm	50mm	1.5mm	4mm
1120-3001WL	50-300mm/1.97-12"	A	±0.07mm	410mm	8mm	25mm	16mm	80mm	2.5mm	4mm
1120-500WL	40-500mm/1.57-20"	A	±0.07mm	680mm	5mm	20mm	24mm	90mm	2.2mm	5.5mm
1120-5001WL	60-500mm/2.36-20"	A	±0.08mm	680mm	10mm	30mm	24mm	120mm	3.4mm	5.5mm
1120-5002WL	80-500mm/3.15-20"	A	±0.08mm	680mm	16mm	40mm	24mm	150mm	5.2mm	5.5mm

Non waterproof, no preset (need to add the width of the jaws on the reading)

Code	Range	Type	Accuracy	L	a	b	c	d	e	f
1120-150B	50-150mm/1.97-6"	B	±0.06mm	270mm	8mm	25mm	20mm	90mm	3.4mm	4mm
1120-200B	60-200mm/2.36-8"	B	±0.06mm	320mm	10mm	30mm	20mm	100mm	3.4mm	4mm
1120-300B	60-300mm/2.36-12"	B	±0.07mm	420mm	10mm	30mm	20mm	110mm	3.4mm	4mm

IP67 dust/waterproof, no automatic power off, set zero after power on each time, no preset (need to add the width of the jaws on the reading), without data interface

Code	Range	Type	Accuracy	L	a	b	c	d	e	f
1120-150P	22-150mm/0.87-6"	C	±0.04mm	250mm	5mm	11mm	16mm	30mm	1mm	4mm

INSIDE GROOVE VERNIER CALIPER

- Measure diameter of grooves inside bores
- Made of stainless steel
- Satin chrome plated reading surface



1262-150A

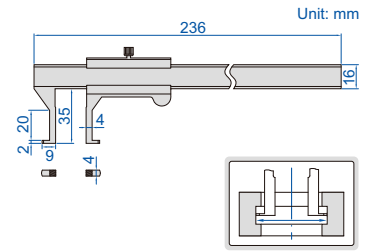

Code	Range	Graduation	Accuracy
1262-150A	18-150mm	0.02mm	±0.04mm

DIGITAL INSIDE GROOVE CALIPERS

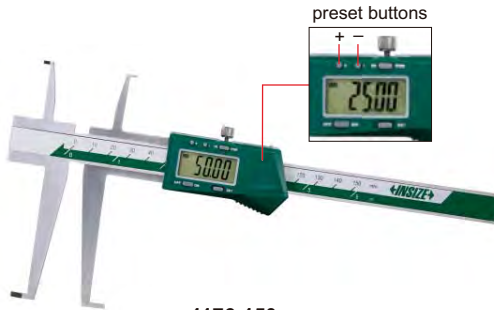

1176-150



1176-150P

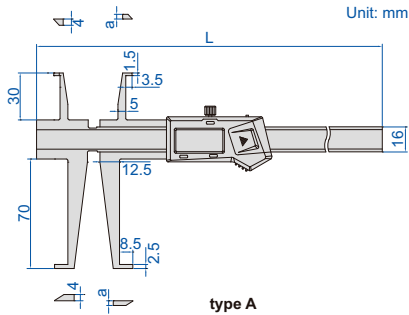

type A

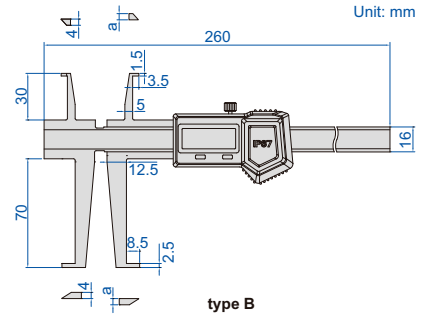

type B

- Measure diameter of grooves inside bores
- Resolution: 0.01mm/0.0005"
- Buttons type A: on/off, set, mm/inch, preset (+, -)
type B: on/off, zero, mm/inch, ABS/REL, hold
- Battery CR2032
- Made of stainless steel
- Optional accessory: depth stop (code 6143)

sizes to be measured
(use upper jaws)

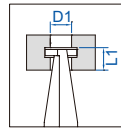

(mm)	
D1	L1
Ø9	<8
Ø10	<15
Ø11~200	<30

sizes to be measured
(use lower jaws)

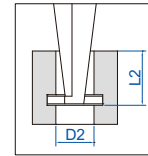

(mm)	
D2	L2
Ø17	<16
Ø18	<28
Ø19	<40
Ø20	<50
Ø21	<58
Ø22~200	<70

Non waterproof, with data interface (data output cable code 7315-21 page 4, 7302-21 page 12, optional)

Code	Range of upper jaw	Range of lower jaw	Type	Accuracy	L	a
1176-150	9-150mm/0.35-6"	17-150mm/0.70-6"	A	±0.04mm	260mm	3mm
1176-200	9-200mm/0.35-8"	17-200mm/0.70-8"	A	±0.05mm	320mm	3.5mm

Non waterproof, built-in wireless (receiver code 7315-2/3/6/7/8/9 is required)

Code	Range of upper jaw	Range of lower jaw	Type	Accuracy	L	a
1176-150WL	9-150mm/0.35-6"	17-150mm/0.70-6"	A	±0.04mm	260mm	3mm
1176-200WL	9-200mm/0.35-8"	17-200mm/0.70-8"	A	±0.05mm	320mm	3.5mm

IP67 dust/waterproof, without data interface, no automatic power off, set zero after power on each time

Code	Range of upper jaw	Range of lower jaw	Type	Accuracy	a
1176-150P	9-150mm/0.35-6"	17-150mm/0.70-6"	B	±0.04mm	4mm

INSIDE GROOVE CALIPER

1199-150

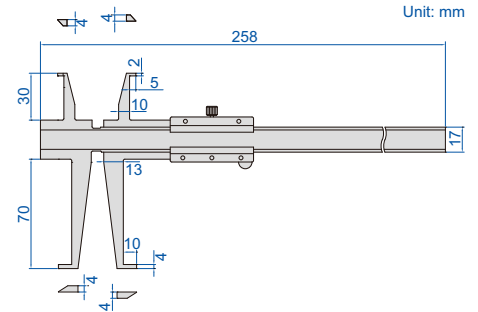
 depth stop **6143**
(optional)

Unit: mm

- Measure diameter of grooves inside bores
- Graduation: 0.02mm
- Made of stainless steel
- Optional accessory: depth stop (code **6143**)

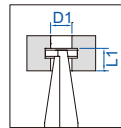
 sizes to be measured
(use upper jaws)

(mm)	
D1	L1
Ø11	<8
Ø12	<10
Ø13	<15
Ø14	<20
Ø15~150	<30

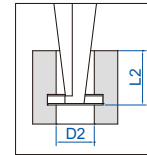
 sizes to be measured
(use lower jaws)

(mm)	
D2	L2
Ø18	<20
Ø19	<28
Ø20	<35
Ø21	<40
Ø22	<50
Ø23~150	<70

Code	Range of upper jaw	Range of lower jaw	Accuracy
1199-150	11-150mm	18-150mm	±0.03mm

DATA OUTPUT
DIGITAL DEEP HOLE INSIDE GROOVE CALIPERS

preset buttons

1129-300

- Non waterproof
- Measure diameter of grooves inside deep holes
- Resolution: 0.01mm/0.0005"
- Buttons: on/off, set, mm/inch, preset (+, -)
- Automatic power off, move the digital unit to turn on power
- Battery CR2032
- Made of stainless steel
- Optional accessory: depth stop (code **6143**)

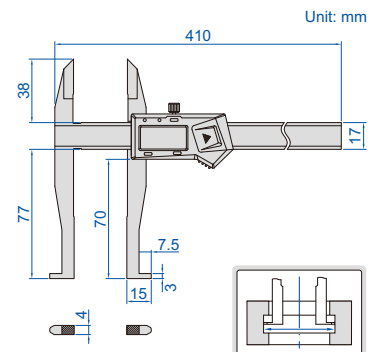
 depth stop **6143** (optional)

Unit: mm

 With data interface (data output cable
code **7315-21** page 4, **7302-21** page 12, optional)

Code	Range of upper jaw	Range of lower jaw	Accuracy
1129-300	0-300mm/0-12"	30-300mm/1.2-12"	±0.04mm

 Built-in wireless (receiver code **7315-2/3/6/7/8/9** is required)

Code	Range of upper jaw	Range of lower jaw	Accuracy
1129-300WL	0-300mm/0-12"	30-300mm/1.2-12"	±0.04mm

DIGITAL INSIDE GROOVE CALIPERS

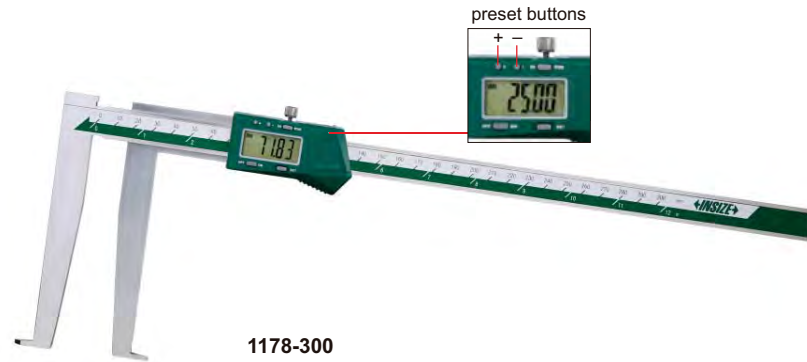

1178-300

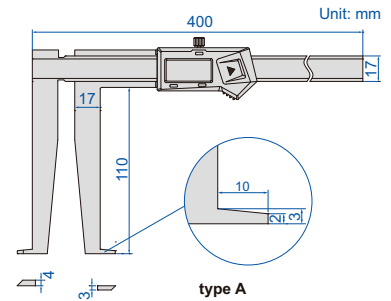

1178-300P

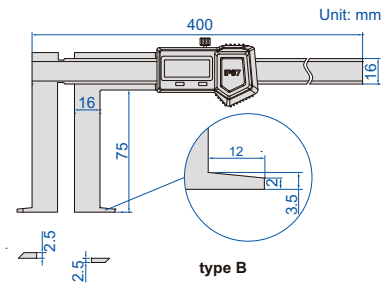

- Measure diameter of grooves inside bores
- Resolution: 0.01mm/0.0005"
- Buttons type A: on/off, set, mm/inch, preset (+, -)
type B: on/off, zero, mm/inch, ABS/REL, hold
- Battery CR2032
- Made of stainless steel
- Optional accessory: depth stop (code **6143**)

Non waterproof, with data interface (data output cable code 7315-21 page 4, 7302-21 page 12, optional)

Code	Range	Type	Accuracy
1178-300	25-300mm/1.18-12"	A	±0.05mm

depth stop 6143 (optional)



Non waterproof, built-in wireless (receiver code 7315-2/3/6/7/8/9 is required)

Code	Range	Type	Accuracy
1178-300WL	25-300mm/1.18-12"	A	±0.05mm

IP67 dust/waterproof, no automatic power off, set zero after power on each time, without data interface

Code	Range	Type	Accuracy
1178-300P	33-300mm/1.30-12"	B	±0.05mm

DIGITAL INSIDE GROOVE CALIPERS

DATA OUTPUT

- Non waterproof
- Measure diameter or distance of grooves
- Resolution: 0.01mm/0.0005"
- Buttons: on/off, set, mm/inch, preset (+, -)
- Automatic power off, move the digital unit to turn on power
- Battery CR2032
- Made of stainless steel



1128-200

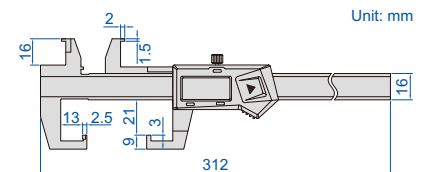

With data interface (data output cable code 7315-21 page 4, 7302-21 page 12, optional)

Code	Range of upper jaw	Range of lower jaw	Accuracy
1128-200	10-200mm/0.39-8"	3-200mm/0.12-8"	±0.03mm

Built-in wireless (receiver code 7315-2/3/6/7/8/9 is required)

Code	Range of upper jaw	Range of lower jaw	Accuracy
1128-200WL	10-200mm/0.39-8"	3-200mm/0.12-8"	±0.03mm

preset buttons

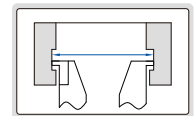
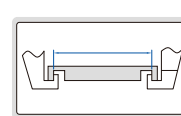

DATA OUTPUT
DIGITAL INSIDE GROOVE CALIPERS

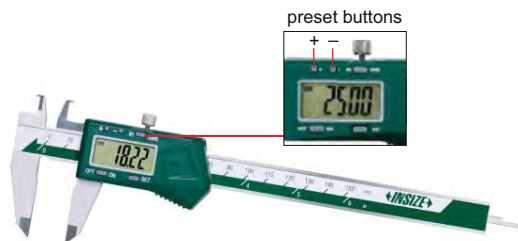
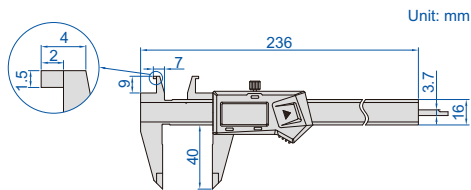
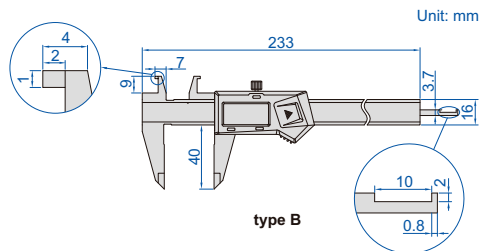
1191-150

1191-150B

type A

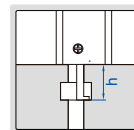
type B

- Non waterproof
- Upper jaws for measuring diameter of grooves
- Resolution: 0.01mm/0.0005"
- Buttons type A: on/off, zero, mm/inch
type B: on/off, set, mm/inch, preset (+, -)
- Automatic power off, move the digital unit to turn on power
- Battery CR2032
- Made of stainless steel

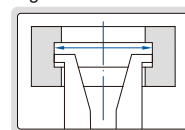
measure depth of grooves (h<10mm, only for type B)



measure diameter of grooves 8-150mm

With data interface

(data output cable code 7315-21 page 4, 7302-21 page 12, optional)

Code	Range of upper jaw	Range of lower jaw	Accuracy	Type
1191-150	8-150mm/0.3-6"	0-150mm/0-6"	±0.03mm	A
1191-150B	8-150mm/0.3-6"	0-150mm/0-6"	±0.03mm	B

Built-in wireless (receiver code 7315-2/3/6/7/8/9 is required)

Code	Range of upper jaw	Range of lower jaw	Accuracy	Type
1191-150WL	8-150mm/0.3-6"	0-150mm/0-6"	±0.03mm	A
1191-150BWL	8-150mm/0.3-6"	0-150mm/0-6"	±0.03mm	B

INSIDE GROOVE VERNIER CALIPER

measure diameter of grooves 8-150mm

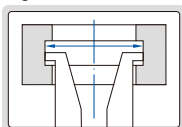

measure depth of grooves (h<10mm)

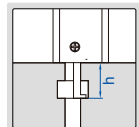
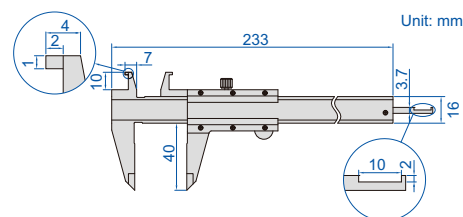
1291-150

- Graduation: 0.02mm
- Made of stainless steel
- Satin chrome plated reading surface

Code	Range of upper jaw	Range of lower jaw	Accuracy
1291-150	8-150mm	0-150mm	±0.03mm

DIGITAL OUTSIDE NECK CALIPERS

- Non waterproof
- Measure grooves and recesses
- Resolution: 0.01mm/0.0005"
- Buttons: on/off, zero, mm/inch
- Automatic power off, move the digital unit to turn on power
- Battery CR2032
- Made of stainless steel
- Optional accessory: depth stop (code **6143**, for calipers with e=16mm)



1187-150A

depth stop 6143 (optional)

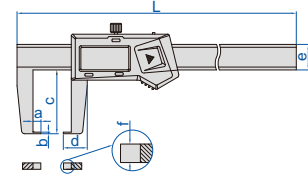
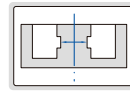

With data interface

(mm)

Code	Range	Accuracy	L	a	b	c	d	e	f	Data output cable (optional)
1187-150A	0-150mm/0-6"	±0.04mm	250	5	1	40	15	16	4	7315-21 page 4, 7302-21 page 12
1187-200A	0-200mm/0-8"	±0.05mm	310	9	1.5	80	23	16	4	7315-21 page 4, 7302-21 page 12
1187-300A	0-300mm/0-12"	±0.06mm	490	12	2	150	36	24	4	7315-22 page 4, 7302-22 page 12
1187-500A	0-500mm/0-20"	±0.07mm	690	12	2	150	36	24	5.5	7315-22 page 4, 7302-22 page 12

Built-in wireless (receiver code 7315-2/3/6/7/8/9 is required)

Code	Range	Accuracy	L	a	b	c	d	e	f
1187-150AWL	0-150mm/0-6"	±0.04mm	250mm	5mm	1mm	40mm	15mm	16mm	4mm
1187-200AWL	0-200mm/0-8"	±0.05mm	310mm	9mm	1.5mm	80mm	23mm	16mm	4mm
1187-300AWL	0-300mm/0-12"	±0.06mm	490mm	12mm	2mm	150mm	36mm	24mm	4mm
1187-500AWL	0-500mm/0-20"	±0.07mm	690mm	12mm	2mm	150mm	36mm	24mm	5.5mm

DIGITAL OUTSIDE POINT CALIPERS

- Non waterproof
- Measure wall thickness inside bores and recesses
- Resolution: 0.01mm/0.0005"
- Buttons: on/off, zero, mm/inch
- Automatic power off, move the digital unit to turn on power
- Battery CR2032
- Made of stainless steel
- Optional accessory: depth stop (code **6143**)



1185-150A

depth stop 6143 (optional)

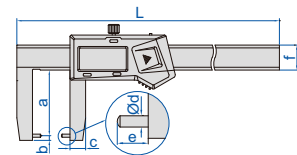
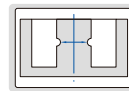

With data interface

(mm)

Code	Range	Accuracy	L	a	b	c	Ød	e	f	Data output cable (optional)
1185-150A	0-150mm/0-6"	±0.04mm	250	40	3	10	2	5	16	7315-21 page 4, 7302-21 page 12
1185-200A	0-200mm/0-8"	±0.05mm	310	80	3	14	3	9	16	7315-21 page 4, 7302-21 page 12
1185-300A	0-300mm/0-12"	±0.06mm	490	150	3	20	3	12	24	7315-22 page 4, 7302-22 page 12

Built-in wireless (receiver code 7315-2/3/6/7/8/9 is required)

(mm)

Code	Range	Accuracy	L	a	b	c	Ød	e	f
1185-150AWL	0-150mm/0-6"	±0.04mm	250	40	3	10	2	5	16
1185-200AWL	0-200mm/0-8"	±0.05mm	310	80	3	14	3	9	16
1185-300AWL	0-300mm/0-12"	±0.06mm	490	150	3	20	3	12	24

DATA OUTPUT
DIGITAL OUTSIDE GROOVE CALIPERS

- Non waterproof
- Measure grooves and recesses in small spaces
- Resolution: 0.01mm/0.0005"
- Buttons: on/off, zero, mm/inch
- Automatic power off, move the digital unit to turn on power
- Battery CR2032
- Made of stainless steel



1535-100



With data interface (data output cable code 7315-21 page 4, 7302-21 page 12, optional)

Code	Range	Accuracy
1535-100	0-100mm/0-4"	±0.03mm

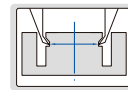
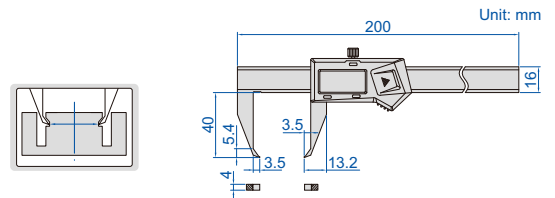
Built-in wireless (receiver code 7315-2/3/6/7/8/9 is required)

Code	Range	Accuracy
1535-100WL	0-100mm/0-4"	±0.03mm

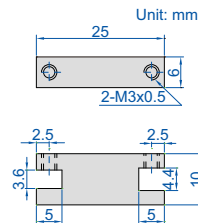
DEPTH STOP FOR CALIPERS

6143

- Supplied in pair
- Made of stainless steel
- Suitable for caliper series 1124, 1526, 1530, 1199, 1520, 1176, 1178, 1120, 1121, 1187, 1129 and 1185

Code
6143

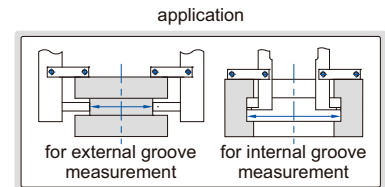
DIGITAL SMALL POINT CALIPERS

- Non waterproof
- Small pointed jaws fit into small grooves and recesses
- Resolution: 0.01mm/0.0005"
- Buttons: on/off, zero, mm/inch
- Automatic power off, move the digital unit to turn on power
- Battery CR2032
- Made of stainless steel



1169-150

With data interface (data output cable code 7315-21 page 4, 7302-21 page 12, optional)

Code	Range	Accuracy
1169-150	0-150mm/0-6"	±0.03mm

Built-in wireless (receiver code 7315-2/3/6/7/8/9 is required)

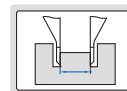
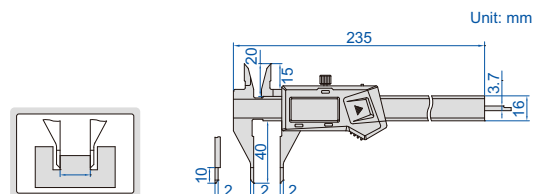
Code	Range	Accuracy
1169-150WL	0-150mm/0-6"	±0.03mm

DATA OUTPUT

DIGITAL POINT CALIPERS

DATA OUTPUT

- Non waterproof
- Pointed jaws fit into small grooves and recesses
- Resolution: 0.01mm/0.0005"
- Buttons: on/off, zero, mm/inch
- Automatic power off, move the digital unit to turn on power
- Battery CR2032
- Made of stainless steel



1183-150A

With data interface
(data output cable code 7315-21 page 4, 7302-21 page 12, optional)

Code	Range	Accuracy	L	a	b	c
1183-150A	0-150mm/0-6"	±0.03mm	236mm	40mm	21mm	16.5mm
1183-200A	0-200mm/0-8"	±0.03mm	286mm	50mm	24mm	19.5mm
1183-300A	0-300mm/0-12"	±0.03mm	400mm	60mm	25mm	21.5mm

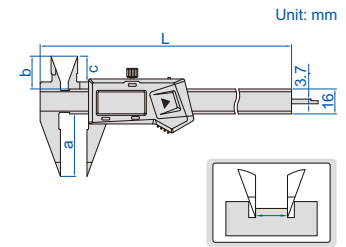

Built-in wireless (receiver code 7315-2/3/6/7/8/9 is required)

Code	Range	Accuracy	L	a	b	c
1183-150AWL	0-150mm/0-6"	±0.03mm	236mm	40mm	21mm	16.5mm
1183-200AWL	0-200mm/0-8"	±0.03mm	286mm	50mm	24mm	19.5mm
1183-300AWL	0-300mm/0-12"	±0.03mm	400mm	60mm	25mm	21.5mm

DIGITAL BLADE CALIPERS

DATA OUTPUT



1188-150A

- Non waterproof
- The blade jaws fit into small grooves
- Resolution: 0.01mm/0.0005"
- Buttons: on/off, zero, mm/inch
- Automatic power off, move the digital unit to turn on power
- Battery CR2032
- Made of stainless steel

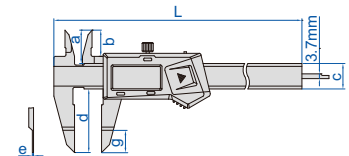

With data interface (data output cable code 7315-21 page 4, 7302-21 page 12, optional)

Code	Range	Accuracy	L	a	b	c	d	e	g
1188-150A	0-150mm/0-6"	±0.03mm	235mm	21mm	16.5mm	16mm	40mm	0.85mm	17mm
1188-200A	0-200mm/0-8"	±0.03mm	297mm	24mm	20mm	16mm	50mm	0.85mm	17mm
1188-300A	0-300mm/0-12"	±0.04mm	390mm	26mm	21.5mm	16mm	60mm	1.00mm	17mm

Built-in wireless (receiver code 7315-2/3/6/7/8/9 is required)

Code	Range	Accuracy	L	a	b	c	d	e	g
1188-150AWL	0-150mm/0-6"	±0.03mm	235mm	21mm	16.5mm	16mm	40mm	0.85mm	17mm
1188-200AWL	0-200mm/0-8"	±0.03mm	297mm	24mm	20mm	16mm	50mm	0.85mm	17mm
1188-300AWL	0-300mm/0-12"	±0.04mm	390mm	26mm	21.5mm	16mm	60mm	1.00mm	17mm

DIGITAL CALIPERS WITH POSITIONING SURFACES

DATA OUTPUT

- Non waterproof
- Lower jaws with positioning surfaces, for measuring inside diameters quickly
- Resolution: 0.01mm/0.0005"
- Buttons: on/off, set, mm/inch, preset (+, -)
- Automatic power off, move the digital unit to turn on power
- Battery CR2032
- Made of stainless steel

With data interface (data output cable code 7315-21 page 4, 7302-21 page 12, optional)

Code	Range	Accuracy
1534-200	0-200mm/0-8"	±0.03mm

Built-in wireless (receiver code 7315-2/3/6/7/8/9 is required)

Code	Range	Accuracy
1534-200WL	0-200mm/0-8"	±0.03mm

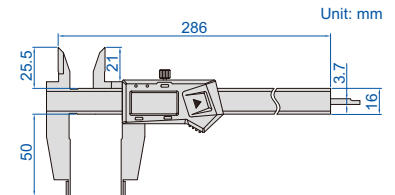
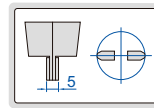
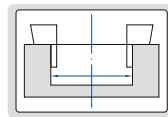

1534-200

preset buttons

DATA OUTPUT

DIGITAL INSIDE KNIFE-EDGE CALIPERS

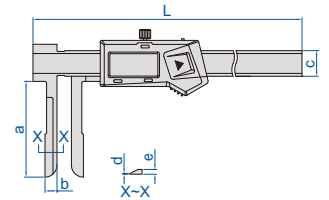
- Non waterproof
- Measure diameter of deep step holes
- Resolution: 0.01mm/0.0005"
- Buttons: on/off, zero, mm/inch
- Automatic power off, move the digital unit to turn on power
- Battery CR2032
- Made of stainless steel

1123-150A

With data interface

Code	Range	Accuracy	L	a	b	c	d	e	Data output cable (optional)
1123-150A	15-150mm/0.6-6"	±0.05mm	250	60	12	16	0.3	3.5	7315-21 page 4, 7302-21 page 12
1123-200A	20-200mm/0.8-8"	±0.06mm	305	100	17	16	0.3	3.5	7315-21 page 4, 7302-21 page 12
1123-300A	24-300mm/0.9-12"	±0.06mm	500	150	22	24	0.5	3.5	7315-22 page 4, 7302-22 page 12

(mm)

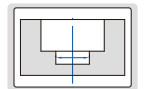

Built-in wireless (receiver code 7315-2/3/6/7/8/9 is required)

(mm)

Code	Range	Accuracy	L	a	b	c	d	e
1123-150AWL	15-150mm/0.6-6"	±0.05mm	250	60	12	16	0.3	3.5
1123-200AWL	20-200mm/0.8-8"	±0.06mm	305	100	17	16	0.3	3.5

DIGITAL CALIPERS WITH KNIFE-EDGE LOWER JAWS

- Non waterproof
- Measure diameter of narrow grooves
- Resolution: 0.01mm/0.0005"
- Buttons: on/off, zero, mm/inch
- Automatic power off, move the digital unit to turn on power
- Battery CR2032
- Made of stainless steel

With data interface (data output cable code 7315-21 page 4, 7302-21 page 12, optional)

Code	Range	Accuracy
1532-200	0-200mm/0-8"	±0.03mm

Built-in wireless (receiver code 7315-2/3/6/7/8/9 is required)

Code	Range	Accuracy
1532-200WL	0-200mm/0-8"	±0.03mm

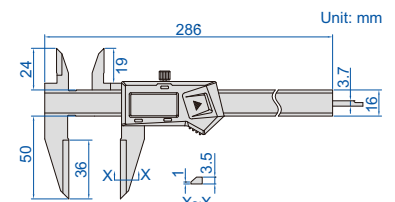
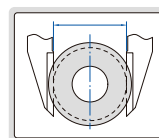
1532-200
DATA OUTPUT

DIGITAL CALIPERS WITH LONG UPPER JAWS

DATA OUTPUT

- Non waterproof
- Long upper jaws for measuring diameter of deep holes
- Resolution: 0.01mm/0.0005"
- Buttons: on/off, zero, mm/inch
- Automatic power off, move the digital unit to turn on power
- Battery CR2032
- Made of stainless steel



1138-200

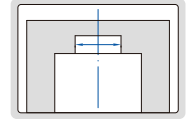

With data interface (data output cable code 7315-21 page 4, 7302-21 page 12, optional)

Code	Range	Accuracy
1138-200	0-200mm/0-8"	±0.04mm

Built-in wireless (receiver code 7315-2/3/6/7/8/9 is required)

Code	Range	Accuracy
1138-200WL	0-200mm/0-8"	±0.04mm

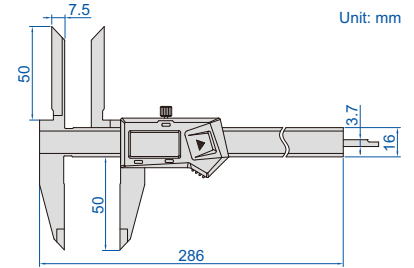

DIGITAL OFFSET CENTERLINE CALIPERS

DATA OUTPUT



1192-150A

- Non waterproof
- Measure hole center distance in the same or offset planes
- Resolution: 0.01mm/0.0005"
- Buttons: on/off, set, mm/inch, preset (+, -)
- Automatic power off, move the digital unit to turn on power
- Battery CR2032
- Made of stainless steel

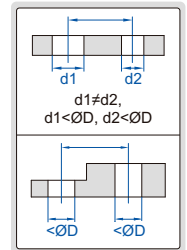
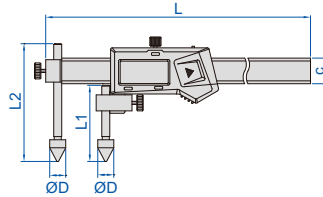

With data interface

(mm)

Code	Range	Accuracy	c	ØD	L1	L2	L	Data output cable (optional)
1192-150A	10-150mm/0.4-6"	±0.05mm	16	10	46	79	236	7315-21 page 4, 7302-21 page 12
1192-200A	10-200mm/0.4-8"	±0.07mm	16	10	46	79	286	7315-21 page 4, 7302-21 page 12
1192-300A	10-300mm/0.4-12"	±0.09mm	16	10	46	79	396	7315-21 page 4, 7302-21 page 12
1192-500A	20-500mm/0.8-20"	±0.09mm	24	20	52	112	725	7315-22 page 4, 7302-22 page 12
1192-1000A	30-1000mm/1.2-40"	±0.12mm	31	30	75	120	1255	7315-22 page 4, 7302-22 page 12
1192-1500A	30-1500mm/1.2-60"	±0.15mm	31	30	75	120	1760	7315-22 page 4, 7302-22 page 12

Built-in wireless (receiver code 7315-2/3/6/7/8/9 is required)

(mm)

Code	Range	Accuracy	c	ØD	L1	L2	L
1192-150AWL	10-150mm/0.4-6"	±0.05mm	16	10	46	79	236
1192-200AWL	10-200mm/0.4-8"	±0.07mm	16	10	46	79	286
1192-300AWL	10-300mm/0.4-12"	±0.09mm	16	10	46	79	396
1192-500AWL	20-500mm/0.8-20"	±0.09mm	24	20	52	112	725

DATA OUTPUT

DIGITAL BACK-JAW CENTERLINE CALIPERS

- Non waterproof
- Measure hole center distance in the same or offset planes
- Resolution: 0.01mm/0.0005"
- Buttons: on/off, set, mm/inch, preset (+, -)
- Automatic power off, move the digital unit to turn on power
- Battery CR2032
- Made of stainless steel



1177-200

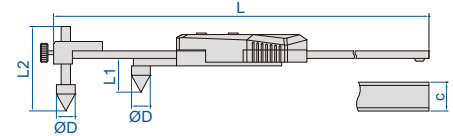
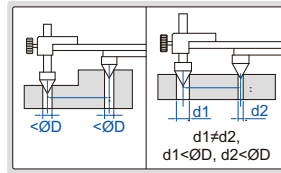

With data interface

Code	Range	Accuracy	ØD	c	L1	L2	L	Data output cable (optional)
1177-200	10-200mm/0.4-8"	±0.10mm	10	16	18	45	310	7315-21 page 4, 7302-21 page 12
1177-300	10-300mm/0.4-12"	±0.10mm	10	16	18	45	410	7315-21 page 4, 7302-21 page 12
1177-500	20-500mm/0.8-20"	±0.10mm	20	24	26	70	692	7315-22 page 4, 7302-22 page 12
1177-1000	30-1000mm/1.2-40"	±0.12mm	30	31	39	70	1242	7315-22 page 4, 7302-22 page 12
1177-1500	30-1500mm/1.2-60"	±0.15mm	30	31	39	70	1745	7315-22 page 4, 7302-22 page 12



Built-in wireless (receiver code 7315-2/3/6/7/8/9 is required)

Code	Range	Accuracy	ØD	c	L1	L2	L
1177-200WL	10-200mm/0.4-8"	±0.10mm	10	16	18	45	310
1177-300WL	10-300mm/0.4-12"	±0.10mm	10	16	18	45	410
1177-500WL	20-500mm/0.8-20"	±0.10mm	20	24	26	70	692

DATA OUTPUT

DIGITAL BACK-JAW EDGE TO CENTER CALIPERS

- Non waterproof
- Measure edge to hole center distance
- Resolution: 0.01mm/0.0005"
- Buttons: on/off, set, mm/inch, preset (+, -)
- Automatic power off, move the digital unit to turn on power
- Battery CR2032
- Made of stainless steel



1524-200



With data interface (data output cable code 7315-21 page 4, 7302-21 page 12, optional)

Code	Range	Accuracy	L
1524-200	5-200mm/0.2-8"	±0.1mm	310mm
1524-300	5-300mm/0.2-12"	±0.1mm	410mm

Built-in wireless (receiver code 7315-2/3/6/7/8/9 is required)

Code	Range	Accuracy	L
1524-200WL	5-200mm/0.2-8"	±0.1mm	310mm
1524-300WL	5-300mm/0.2-12"	±0.1mm	410mm

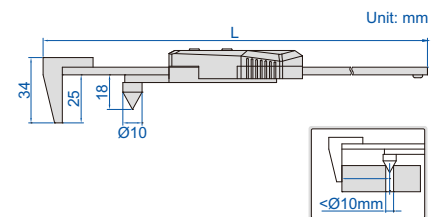

DIGITAL CENTERLINE AND EDGE TO CENTER CALIPERS

DATA OUTPUT



1525-300



- Non waterproof
- Measure hole center distance or edge to hole center distance
- Resolution: 0.01mm/0.0005"
- Buttons: on/off, set, mm/inch, preset (+, -)
- Automatic power off, move the digital unit to turn on power
- Battery CR2032
- Made of stainless steel

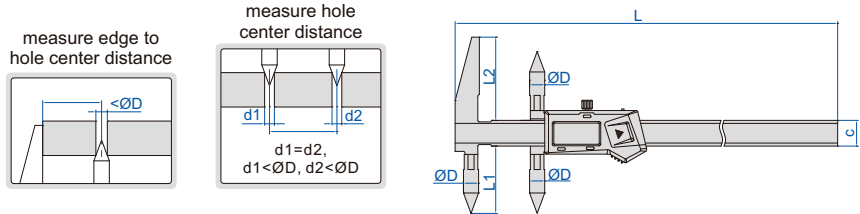

With data interface

Code	Range of upper jaw (edge to center)	Range of lower jaw (center to center)	Accuracy	ØD	L1	L2	c	L	Data output cable (optional)
1525-300	5-300mm/0.2-12"	10-300mm/0.4-12"	±0.08mm	10	44.5	55	17	410	7315-21 page 4, 7302-21 page 12
1525-3001	10-300mm/0.4-12"	20-300mm/0.8-12"	±0.08mm	20	48	60	17	410	7315-21 page 4, 7302-21 page 12
1525-500	10-500mm/0.4-20"	20-500mm/0.8-20"	±0.09mm	20	50	60	24	690	7315-22 page 4, 7302-22 page 12
1525-1000	15-1000mm/0.6-40"	30-1000mm/1.2-40"	±0.12mm	30	70	81	31	1255	7315-22 page 4, 7302-22 page 12
1525-1500	15-1500mm/0.6-60"	30-1500mm/1.2-60"	±0.15mm	30	70	81	31	1760	7315-22 page 4, 7302-22 page 12

Built-in wireless (receiver code 7315-2/3/6/7/8/9 is required)

Code	Range of upper jaw (edge to center)	Range of lower jaw (center to center)	Accuracy	ØD	L1	L2	c	L
1525-300WL	5-300mm/0.2-12"	10-300mm/0.4-12"	±0.08mm	10	44.5	55	17	410
1525-3001WL	10-300mm/0.4-12"	20-300mm/0.8-12"	±0.08mm	20	48	60	17	410
1525-500WL	10-500mm/0.4-20"	20-500mm/0.8-20"	±0.09mm	20	50	60	24	690

DIGITAL HOOK CALIPERS

DATA OUTPUT



1122-300

- Non waterproof
- Measure width and distance of grooves inside bores
- Resolution: 0.01mm/0.0005"
- Buttons: on/off, zero, mm/inch
- Automatic power off, move the digital unit to turn on power
- Battery CR2032
- Made of stainless steel

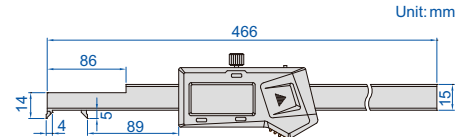

With data interface (data output cable code 7315-21 page 4, 7302-21 page 12, optional)

Code	Range	Accuracy
1122-300	4-300mm/0.16-12"	±0.04mm

Built-in wireless (receiver code 7315-2/3/6/7/8/9 is required)

Code	Range	Accuracy
1122-300WL	4-300mm/0.16-12"	±0.04mm

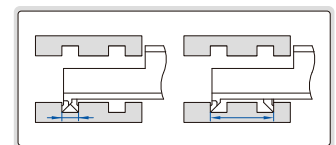

DATA
OUTPUT

DIGITAL CALIPERS WITH ONE DIRECTION UPPER JAWS

2



1184-200



1184-150A

- Non waterproof
- Resolution: 0.01mm/0.0005"
- Buttons: zero, power on/off, inch/mm
- Automatic power off, move the digital unit to turn on power
- Battery CR2032
- Data output
- Made of stainless steel
- Optional accessory: data output cable (code 7315-21 page 4, 7302-21 page 12)

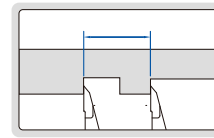
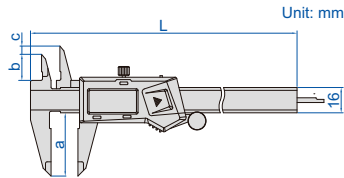

jaws with same height used for measuring the distance in same level

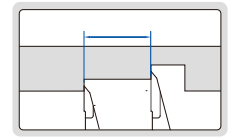

jaws with different height used for measuring the distance in different level

Jaws with same height

(mm)

Code	Range	Accuracy	L	a	b	c
1184-150	0-150mm/0-6"	±0.03mm	236	40	17	0
1184-200	0-200mm/0-8"	±0.03mm	286	50	20	0
1184-300	0-300mm/0-12"	±0.03mm	400	60	22	0

Jaws with different height

(mm)

Code	Range	Accuracy	L	a	b	c
1184-150A	0-150mm/0-6"	±0.03mm	236	40	17	5
1184-200A	0-200mm/0-8"	±0.03mm	286	50	20	8
1184-300A	0-300mm/0-12"	±0.03mm	400	60	22	10

DATA
OUTPUT

DIGITAL OFFSET CALIPERS



1186-150A

- Non waterproof
- The left jaw can slide up and down to facilitate measurement of stepped sections
- Resolution: 0.01mm/0.0005"
- Buttons: on/off, zero, mm/inch
- Automatic power off, move the digital unit to turn on power
- Battery CR2032
- Made of stainless steel

With data interface

(data output cable code 7315-21 page 4, 7302-21 page 12, optional)

(mm)

Code	Range	Accuracy	L	a	b	c	d	e	f
1186-150A	0-150mm/0-6"	±0.04mm	249	40	16.5	10	110	17	7
1186-200A	0-200mm/0-8"	±0.04mm	299	50	19.5	10	120	17	7
1186-300A	0-300mm/0-12"	±0.05mm	399	60	20.5	10	130	17	7

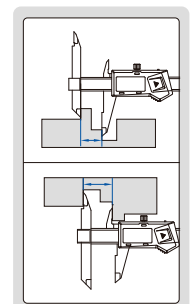
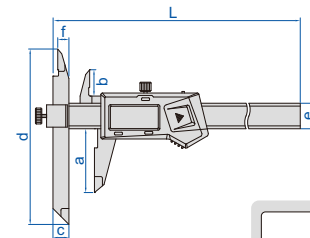

Built-in wireless (receiver code 7315-2/3/6/7/8/9 is required)

(mm)

Code	Range	Accuracy	L	a	b	c	d	e	f
1186-150AWL	0-150mm/0-6"	±0.04mm	249	40	16.5	10	110	17	7
1186-200AWL	0-200mm/0-8"	±0.04mm	299	50	19.5	10	120	17	7
1186-300AWL	0-300mm/0-12"	±0.05mm	399	60	20.5	10	130	17	7

DIGITAL TUBE THICKNESS CALIPERS

DATA OUTPUT

- Non waterproof
- Measure wall thickness of tubes
- Resolution: 0.01mm/0.0005"
- Buttons: on/off, zero, mm/inch
- Automatic power off, move the digital unit to turn on power
- Battery CR2032
- Made of stainless steel



1161-150A

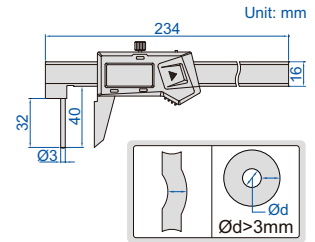

With data interface (data output cable code 7315-21 page 4, 7302-21 page 12, optional)

Code	Range	Accuracy
1161-150A	0-150mm/0-6"	±0.05mm

Built-in wireless (receiver code 7315-2/3/6/7/8/9 is required)

Code	Range	Accuracy
1161-150AWL	0-150mm/0-6"	±0.05mm

DIGITAL RTJ RING GROOVE CALIPERS

DATA OUTPUT

- Non waterproof
- Angle of RTJ ring groove: 23°
- Measure ring grooves of flange
- Resolution: 0.01mm/0.0005"
- Button function: on/off, set, zero, mm/inch, data preset
- Battery CR2032
- Made of stainless steel

preset buttons

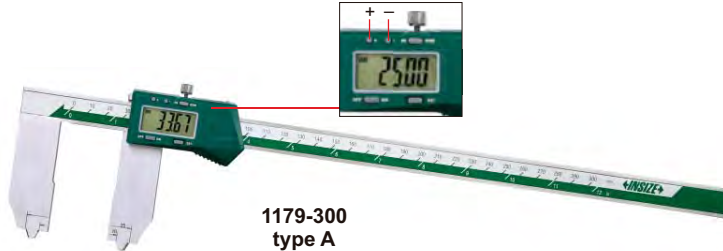

1179-300 type A

applicable for RTJ ring grooves with angle 23°

d and e need to be added on the reading

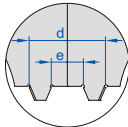
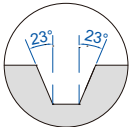

1179-600 type B

measure outside diameter of RTJ ring groove

measure inside diameter of RTJ ring groove

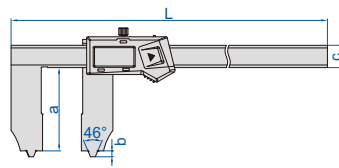
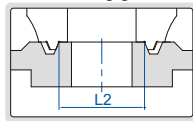
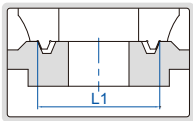

type A

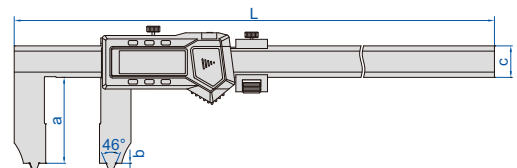

type B

With data interface

(mm)

Code	Range (inside diameter of RTJ ring groove)	Range (outside diameter of RTJ ring groove)	Accuracy	Type	L	a	b	c	d	e	Data output cable (optional)
1179-300	10-300mm/0.4-12"	25-300mm/1-12"	±0.06mm	A	410	63.5	4.5	17	25	10	7315-21 page 4, 7302-21 page 12
1179-600	10-600mm/0.4-24"	25-600mm/1-24"	±0.07mm	B	770	65.5	4.5	24	25	10	7315-22 page 4, 7302-22 page 12
1179-1000	15-1000mm/0.6-40"	30-1000mm/1.2-40"	±0.09mm	B	1220	90	5	31	30	15	7315-22 page 4, 7302-22 page 12

Built-in wireless (receiver code 7315-2/3/6/7/8/9 is required)

(mm)

Code	Range (inside diameter of RTJ ring groove)	Range (outside diameter of RTJ ring groove)	Accuracy	Type	L	a	b	c	d	e
1179-300WL	10-300mm/0.4-12"	25-300mm/1-12"	±0.06mm	A	410	63.5	4.5	17	25	10
1179-600WL	10-600mm/0.4-24"	25-600mm/1-24"	±0.07mm	B	770	65.5	4.5	24	25	10

DIGITAL CALIPERS WITH INTERCHANGEABLE BALL TIPS

DATA OUTPUT

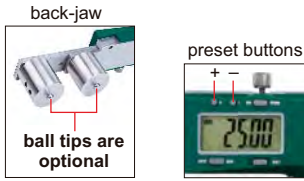

1527-3001

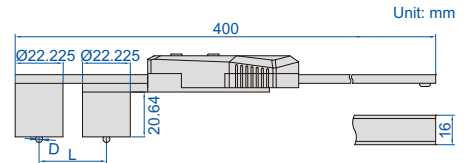

- Non waterproof
- Resolution 0.01mm/0.0005"
- Buttons: on/off, set, mm/inch, preset (+, -)
- Automatic power off, move the digital unit to turn on power
- Battery CR2032
- Made of stainless steel
- Optional accessory: ball tips

With data interface (data output cable code 7315-21 page 4, 7302-21 page 12, optional)

Code	Range	Accuracy
1527-3001	(22.22+D)~300mm*	±0.03mm

Built-in wireless (receiver code 7315-2/3/6/7/8/9 is required)

Code	Range	Accuracy
1527-3001WL	(22.22+D)~300mm*	±0.03mm

*"D" is the diameter of ball tips.

Ball tips (optional, supplied in pair)



Code	Diameter (D)	Accuracy of diameter	Type	Material
1527-T101	1/16" (Ø1.5875mm)	±0.005mm	A	ruby
1527-T102	1/8" (Ø3.175mm)	±0.005mm	B	stainless steel
1527-T103	3/16" (Ø4.7625mm)	±0.005mm	B	stainless steel
1527-T104	1/4" (Ø6.35mm)	±0.005mm	B	stainless steel
1527-T105	3/8" (Ø9.525mm)	±0.005mm	B	stainless steel
1527-T106	1/2" (Ø12.7mm)	±0.005mm	B	stainless steel

DATA OUTPUT

DIGITAL CALIPERS WITH INTERCHANGEABLE BALL TIPS

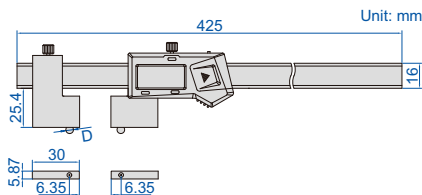

ball tips are optional

1528-3001



- Non waterproof
- Resolution 0.01mm/0.0005"
- Buttons: on/off, set, mm/inch, preset (+, -)
- Automatic power off, move the digital unit to turn on power
- Battery CR2032
- Made of stainless steel
- Optional accessory: ball tips

With data interface (data output cable code 7315-21 page 4, 7302-21 page 12, optional)

Code	Range	Accuracy
1528-3001	(12.7+D)~300mm*	±0.03mm

Built-in wireless (receiver code 7315-2/3/6/7/8/9 is required)

Code	Range	Accuracy
1528-3001WL	(12.7+D)~300mm*	±0.03mm

*"D" is the diameter of ball tips.

Ball tips (optional, supplied in pair)



Code	Diameter (D)	Accuracy of diameter	Type	Material
1527-T101	1/16" (Ø1.5875mm)	±0.005mm	A	ruby
1527-T102	1/8" (Ø3.175mm)	±0.005mm	B	stainless steel
1527-T103	3/16" (Ø4.7625mm)	±0.005mm	B	stainless steel
1527-T104	1/4" (Ø6.35mm)	±0.005mm	B	stainless steel
1527-T105	3/8" (Ø9.525mm)	±0.005mm	B	stainless steel
1527-T106	1/2" (Ø12.7mm)	±0.005mm	B	stainless steel

DIGITAL CRIMP HEIGHT CALIPERS

- Non waterproof
- Measure crimp height
- Resolution: 0.01mm/0.0005"
- Buttons: on/off, zero, mm/inch
- Automatic power off, move the digital unit to turn on power
- Battery CR2032, meet DIN862
- Made of stainless steel



1165-150A

RELATIVE PRODUCT: CRIMP HEIGHT MICROMETER (CODE 3266-25BA, 3566-25BA)

DATA OUTPUT

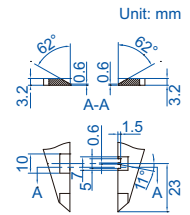

With data interface (data output cable code 7315-21 page 4, 7302-21 page 12, optional)

Code	Range	Accuracy
1165-150A	0-150mm/0-6"	±0.03mm

Built-in wireless (receiver code 7315-2/3/6/7/8/9 is required)

Code	Range	Accuracy
1165-150AWL	0-150mm/0-6"	±0.03mm

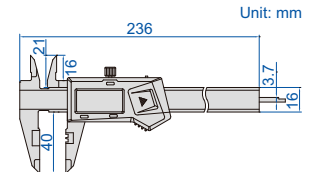

DIGITAL CALIPERS WITH LARGE MEASURING FACES

- Non waterproof
- Measure diameter of wire ropes, and thickness of soft materials like rubber, sponge, etc.
- Resolution: 0.01mm/0.0005"
- Buttons: on/off, zero, mm/inch
- Automatic power off, move the digital unit to turn on power
- Battery CR2032
- Made of stainless steel



1172-200

DATA OUTPUT

With data interface (data output cable code 7315-21 page 4, 7302-21 page 12, optional)

Code	Range	Accuracy
1172-200	0-200mm/0-8"	±0.07mm

Built-in wireless (receiver code 7315-2/3/6/7/8/9 is required)

Code	Range	Accuracy
1172-200WL	0-200mm/0-8"	±0.07mm

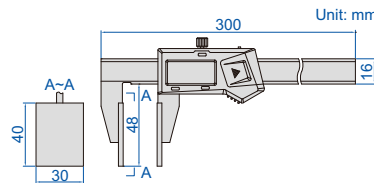

measure diameter of wire ropes

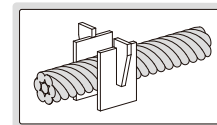

measure thickness of rubber, sponge, etc.

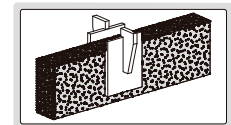

DIGITAL CALIPERS WITH DISK FACES

- Non waterproof
- Measure thickness of soft sheets
- Resolution: 0.01mm/0.0005"
- Buttons: on/off, zero, mm/inch
- Automatic power off, move the digital unit to turn on power
- Battery CR2032
- Made of stainless steel



1533-150

DATA OUTPUT

With data interface

Code	Range	Accuracy	L	a	b	c	Ød	Data output cable (optional)
1533-150	0-150mm/0-6"	±0.04mm	245	50	11	16	20	7315-21 page 4, 7302-21 page 12
1533-200	0-200mm/0-8"	±0.05mm	310	80	11	16	30	7315-21 page 4, 7302-21 page 12
1533-500	0-500mm/0-20"	±0.07mm	680	150	12.5	24	50	7315-22 page 4, 7302-22 page 12

Built-in wireless (receiver code 7315-2/3/6/7/8/9 is required)

Code	Range	Accuracy	L	a	b	c	Ød
1533-150WL	0-150mm/0-6"	±0.04mm	245	50	11	16	20
1533-200WL	0-200mm/0-8"	±0.05mm	310	80	11	16	30
1533-500WL	0-500mm/0-20"	±0.07mm	680	150	12.5	24	50

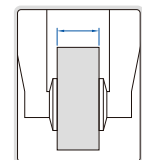
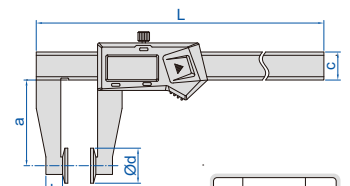

DATA OUTPUT

DIGITAL WALL THICKNESS CALIPERS

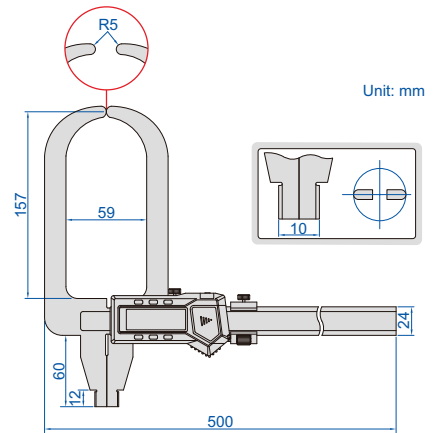
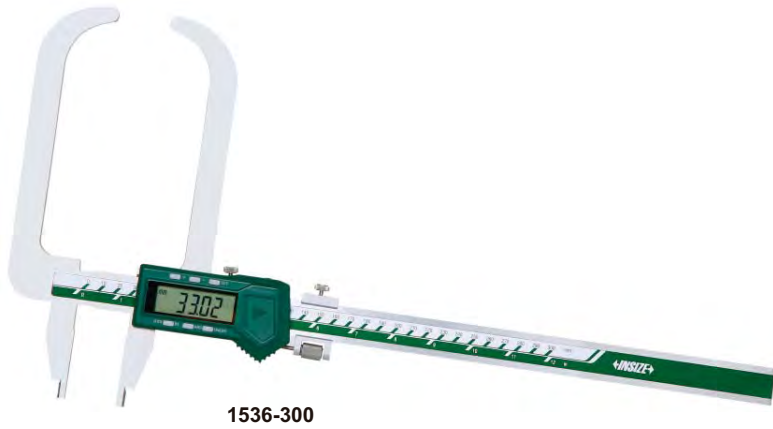

With data interface (data output cable code 7315-22 page 4, 7302-22 page 12, optional)

Code	Range	Accuracy
1536-300	0-300mm/0-12"	±0.05mm

Built-in wireless (receiver code 7315-2/3/6/7/8/9 is required)

Code	Range	Accuracy
1536-300WL	0-300mm/0-12"	±0.05mm

- Non waterproof
- Measure wall thickness of helmets, domes and curved pots
- Resolution: 0.01mm/0.0005"
- Buttons: on/off, zero, mm/inch, ABS, data preset
- Automatic power off, move the digital unit to turn on power
- Battery CR2032
- Made of stainless steel

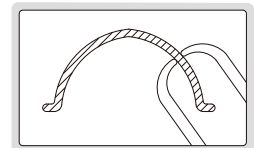

ATTENTION: ACTUAL DIAMETER IS 2/3 OF THE READING

DIGITAL V SHAPE CALIPER

- Non waterproof
- Measure outside diameter of three number of flutes (such as taps, reamers, end mills and gears)
- Resolution: 0.01mm/0.0005"
- Buttons: on/off, set, mm/inch, preset (+, -)
- Battery CR2032
- Automatic power off, move the digital unit to turn on power
- Data output
- Made of stainless steel

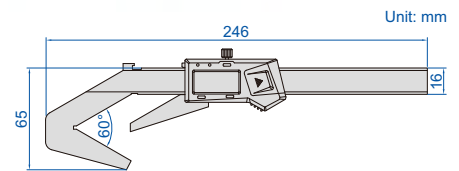

Code	Range	Accuracy
1539-3	Ø4-Ø40mm/0.16"-1.58" DIA	±0.03mm

V SHAPE VERNIER CALIPER

- Measure outside diameter of three number of flutes (such as taps, reamers, end mills and gears)
- Made of stainless steel
- Satin chrome plated reading surface

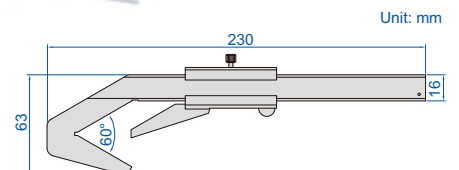

Code	Range	Graduation	Accuracy
1273-403	Ø4-40mm	0.05mm	±0.05mm

V SHAPE VERNIER CALIPERS

- Measure outside diameter of odd number of flutes (such as taps, reamers, end mills and gears)
- Made of stainless steel
- Satin chrome plated reading surface
- Optional accessory: 4mm pin gage (code **4110-4D00**), Ø50mm calibration cylinder (code **6316-50**)



1229-3

Code	Range (ØD)	Graduation	Accuracy	Flutes	Angle α	L	c
1229-3	Ø4-60mm	0.02mm	±0.04mm	3	60°	260mm	16mm
1229-35	Ø50-200mm	0.02mm	±0.06mm	3	60°	516mm	20mm
1229-5	Ø4-60mm	0.02mm	±0.04mm	5	108°	210mm	16mm
1229-55	Ø50-200mm	0.02mm	±0.06mm	5	108°	360mm	20mm

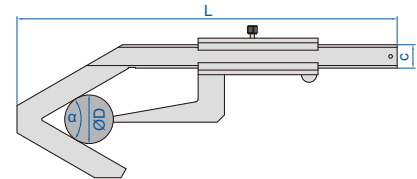

DIGITAL GEAR TOOTH CALIPERS

ATTENTION:
NO DATA OUTPUT

- Non waterproof
- Resolution: 0.01mm/0.0005"
- Carbide tips
- Measure the tooth thickness by positioning the tooth height (for tooth height > 1mm)
- Buttons: zero, on/off, mm/inch
- Automatic power off, move the digital unit to turn on power
- Battery CR2032
- Made of stainless steel



1181-M25A

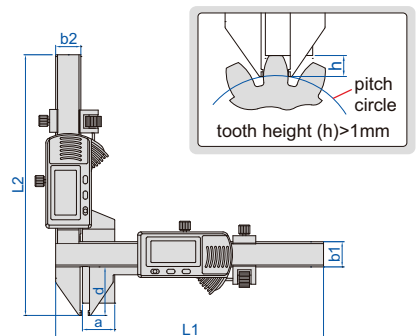

Code	Range	Accuracy of height measurement	Accuracy of thickness measurement	Total accuracy	L1	L2	a	b1	b2	d
1181-M25A	M1-25mm	±0.03mm	±0.03mm	±0.04mm	170mm	165.5mm	21mm	16mm	16mm	30.5mm
1181-M50A	M5-50mm	±0.03mm	±0.03mm	±0.04mm	220mm	190mm	50.5mm	16mm	16mm	55mm

GEAR TOOTH VERNIER CALIPER

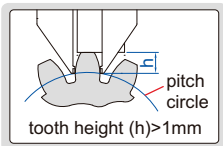

- Carbide tips
- Measure the tooth thickness by positioning the tooth height (for tooth height > 1mm)
- Made of stainless steel
- Satin chrome plated reading surface



1281-M26A

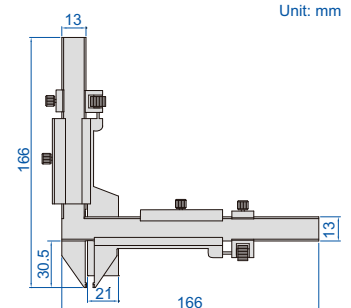

Code	Range	Graduation	Accuracy of height measurement	Accuracy of thickness measurement	Total accuracy
1281-M26A	M1-26mm	0.02mm	±0.03mm	±0.03mm	±0.04mm

REFER TO PAGE 191 FOR DETAILS



1189-150B

DIGITAL ARC RADIUS CALIPERS

REFER TO PAGE 393 FOR DETAILS



1166-150A

DIGITAL SCRIBING CALIPERS

- Non waterproof
- Measure thickness of disk brakes
- Resolution 0.01mm/0.0005"
- Buttons: on/off, zero, mm/inch
- Automatic power off, move the digital unit to turn on power
- Battery CR2032
- Made of stainless steel

RELATIVE PRODUCT: DISK BRAKE MICROMETER (CODE 3288-, 3588-)

DATA OUTPUT



1162-125A

DIGITAL DISK BRAKE CALIPERS

With data interface (data output cable code 7315-21 page 4, 7302-21 page 12, optional)

Code	Range	Accuracy
1162-125A	0-125mm/0-5"	±0.05mm

Built-in wireless (receiver code 7315-2/3/6/7/8/9 is required)

Code	Range	Accuracy
1162-125AWL	0-125mm/0-5"	±0.05mm

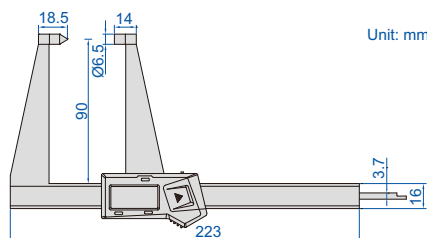

DATA OUTPUT

RELATIVE PRODUCT: DISK BRAKE MICROMETER (CODE 3288-, 3588-)

DIGITAL DISK BRAKE AND PAD CALIPERS

- Non waterproof
- Measure thickness of disk brakes and pad wear
- Resolution: 0.01mm/0.0005"
- Buttons: on/off, zero, mm/inch
- Automatic power off, move the digital unit to turn on power
- Battery CR2032
- Made of stainless steel



1167-150A

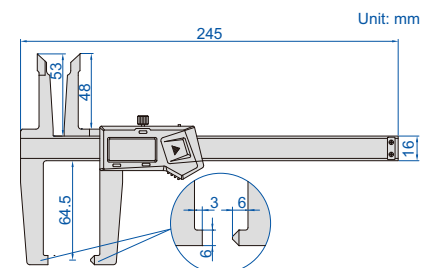

With data interface (data output cable code 7315-21 page 4, 7302-21 page 12, optional)

Code	Range	Accuracy
1167-150A	0-150mm/0-6"	±0.07mm

Built-in wireless (receiver code 7315-2/3/6/7/8/9 is required)

Code	Range	Accuracy
1167-150AWL	0-150mm/0-6"	±0.07mm



DIGITAL DRUM BRAKE CALIPERS

RELATIVE PRODUCT: DISK BRAKE MICROMETER (CODE 3288-, 3588-)

DATA OUTPUT



1168-300A

- Non waterproof
- Measure internal and external diameter of drum brakes
- Resolution 0.01mm/0.0005"
- Buttons: on/off, zero, mm/inch
- Automatic power off, move the digital unit to turn on power
- Battery CR2032
- Made of stainless steel

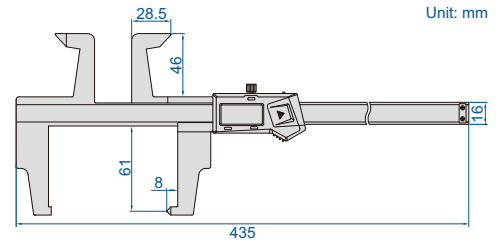

With data interface (data output cable code 7315-21 page 4, 7302-21 page 12, optional)

Code	Range	Accuracy
1168-300A	0-300mm/0-12"	±0.07mm

Built-in wireless (receiver code 7315-2/3/6/7/8/9 is required)

Code	Range	Accuracy
1168-300AWL	0-300mm/0-12"	±0.07mm



DIGITAL DRUM BRAKE CALIPER

DATA OUTPUT

calibration block (included)



1538-300

- Non waterproof
- Measure internal diameter of drum brakes
- Resolution: 0.01mm/0.0005"
- Buttons: on/off, zero, mm/inch
- Automatic power off, move the digital unit to turn on power
- Battery CR2032
- Data output
- Made of stainless steel
- Optional accessory: data output cable (code 7315-22 page 4, 7302-22 page 12)

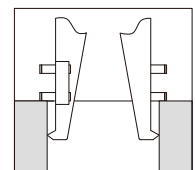
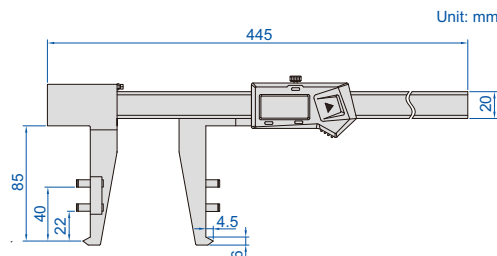

Code	Range	Accuracy
1538-300	30-300mm/1.2-12"	±0.05mm



Digital Depth Gages
Page 66-70



Dial Depth Gages
Page 70



Vernier Depth Gages
Page 70-72



Extension Bases
Page 72



Mini Depth Gages
Page 72-73



Depth Gages
Page 74-77



Depth Micrometers
Page 78-79



Depth Micrometer Checkers
Page 79

IP67 WATERPROOF DIGITAL DEPTH GAGES

IP67
WATERPROOF

ATTENTION: NO
DATA OUTPUT

ATTENTION: IT IS NECESSARY TO SET
ZERO AFTER POWER ON EACH TIME

3

- IP67 dust/waterproof
- Resolution: 0.01mm/0.0005"
- Button function: zero, on/off, mm/inch, ABS/REL, hold
- Meet DIN862
- Battery CR2032
- Made of stainless steel



1149-150

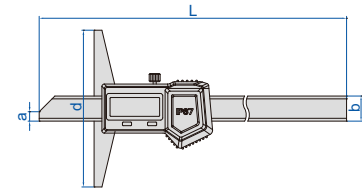

Code	Range	Accuracy	L	a	b	d
1149-150	0-150mm/0-6"	±0.03mm	240mm	6mm	16mm	100mm
1149-200	0-200mm/0-8"	±0.03mm	290mm	6mm	16mm	100mm
1149-300	0-300mm/0-12"	±0.03mm	390mm	6mm	16mm	150mm

DIGITAL DEPTH GAGES (STANDARD TYPE)

POPULAR
MODEL

DATA
OUTPUT

- Non waterproof
- Buttons: on/off, zero, mm/inch
- Automatic power off, move the digital unit to turn on power
- Meet DIN862 (except 0-500mm/0-20", 0-1000mm/0-40", 0-1500mm/0-60")
- Battery CR2032
- Made of stainless steel



1141-150A

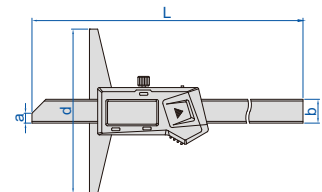

With data interface

Code	Range	Resolution	Accuracy	L	a	b	d	Data output cable (optional)
1141-150A	0-150mm/0-6"	0.01mm/0.0005"	±0.03mm	230mm	6mm	14.5mm	100mm	7315-21 page 4, 7302-21 page 12
1141-200A	0-200mm/0-8"	0.01mm/0.0005"	±0.03mm	280mm	6mm	14.5mm	100mm	7315-21 page 4, 7302-21 page 12
1141-300A	0-300mm/0-12"	0.01mm/0.0005"	±0.03mm	380mm	6mm	14.5mm	150mm	7315-21 page 4, 7302-21 page 12
1141-500A	0-500mm/0-20"	0.01mm/0.0005"	±0.05mm	585mm	7mm	15mm	150mm	7315-22 page 4, 7302-22 page 12
1141-5001A	0-500mm/0-20"	0.01mm/0.0005"	±0.05mm	585mm	7mm	15mm	200mm	7315-22 page 4, 7302-22 page 12
1141-1000A	0-1000mm/0-40"	0.01mm/0.0005"	±0.07mm	1188mm	7mm	18mm	150mm	7315-22 page 4, 7302-22 page 12
1141-10001A	0-1000mm/0-40"	0.01mm/0.0005"	±0.07mm	1188mm	7mm	18mm	200mm	7315-22 page 4, 7302-22 page 12
1141-10002A	0-1000mm/0-40"	0.01mm/0.0005"	±0.07mm	1188mm	7mm	18mm	250mm	7315-22 page 4, 7302-22 page 12
1141-10003A	0-1000mm/0-40"	0.01mm/0.0005"	±0.07mm	1188mm	7mm	18mm	300mm	7315-22 page 4, 7302-22 page 12
1141-1500A	0-1500mm/0-60"	0.01mm/0.0005"	±0.11mm	1695mm	7mm	18mm	200mm	7315-22 page 4, 7302-22 page 12

Built-in wireless (receiver code 7315-2/3/6/7/8/9 is required)

Code	Range	Resolution	Accuracy	L	a	b	d
1141-150AWL	0-150mm/0-6"	0.01mm/0.0005"	±0.03mm	230mm	6mm	14.5mm	100mm
1141-200AWL	0-200mm/0-8"	0.01mm/0.0005"	±0.03mm	280mm	6mm	14.5mm	100mm
1141-300AWL	0-300mm/0-12"	0.01mm/0.0005"	±0.03mm	380mm	6mm	14.5mm	150mm
1141-500AWL	0-500mm/0-20"	0.01mm/0.0005"	±0.05mm	585mm	7mm	15mm	150mm
1141-5001AWL	0-500mm/0-20"	0.01mm/0.0005"	±0.05mm	585mm	7mm	15mm	200mm

DATA OUTPUT
DIGITAL DEPTH GAGES WITH MOUNTING HOLES FOR EXTENSION BASE

1147-300

- Non waterproof
- Resolution: 0.01mm/0.0005"
- Buttons: on/off, zero, mm/inch
- Automatic power off, move the digital unit to turn on power
- Meet DIN862
- Battery CR2032
- Made of stainless steel
- Optional accessory: extension base (code **6141**)

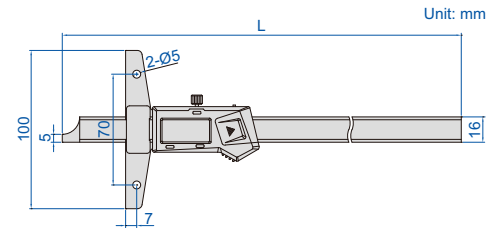
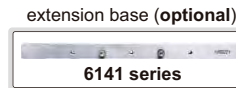

With data interface
(data output cable code **7315-21** page 4, **7302-21** page 12, optional)

Code	Range	Accuracy	L
1147-150	0-150mm/0-6"	±0.03mm	237mm
1147-200	0-200mm/0-8"	±0.03mm	287mm
1147-300	0-300mm/0-12"	±0.03mm	403mm
1147-500	0-500mm/0-20"	±0.05mm	605mm
1147-700	0-700mm/0-28"	±0.06mm	805mm

Built-in wireless (receiver code **7315-2/3/6/7/8/9** is required)

Code	Range	Accuracy	L
1147-150WL	0-150mm/0-6"	±0.03mm	237mm
1147-200WL	0-200mm/0-8"	±0.03mm	287mm
1147-300WL	0-300mm/0-12"	±0.03mm	403mm
1147-500WL	0-500mm/0-20"	±0.05mm	605mm
1147-700WL	0-700mm/0-28"	±0.06mm	805mm

DATA OUTPUT
DIGITAL HOOK DEPTH GAGES

1142-150A

- Non waterproof
- Resolution: 0.01mm/0.0005"
- Buttons: on/off, zero, mm/inch
- Automatic power off, move the digital unit to turn on power
- Battery CR2032
- Made of stainless steel

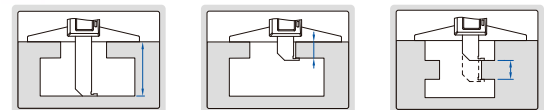
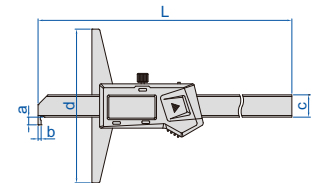

With data interface

Code	Range	Accuracy	L	d	a	b	c	Data output cable (optional)
1142-150A	0-150mm/0-6"	±0.03mm	230mm	100mm	5mm	2mm	14.5mm	7315-21 page 4, 7302-21 page 12
1142-200A	0-200mm/0-8"	±0.03mm	280mm	100mm	5mm	2mm	14.5mm	7315-21 page 4, 7302-21 page 12
1142-300A	0-300mm/0-12"	±0.04mm	380mm	150mm	5mm	2mm	14.5mm	7315-21 page 4, 7302-21 page 12
1142-500A	0-500mm/0-20"	±0.05mm	585mm	150mm	8mm	3mm	15mm	7315-22 page 4, 7302-22 page 12
1142-5001A	0-500mm/0-20"	±0.05mm	585mm	200mm	8mm	3mm	15mm	7315-22 page 4, 7302-22 page 12
1142-1000A	0-1000mm/0-40"	±0.07mm	1188mm	150mm	10mm	4mm	18mm	7315-22 page 4, 7302-22 page 12
1142-10001A	0-1000mm/0-40"	±0.07mm	1188mm	200mm	10mm	4mm	18mm	7315-22 page 4, 7302-22 page 12
1142-10002A	0-1000mm/0-40"	±0.07mm	1188mm	250mm	10mm	4mm	18mm	7315-22 page 4, 7302-22 page 12

Built-in wireless (receiver code **7315-2/3/6/7/8/9** is required)

Code	Range	Accuracy	L	d	a	b	c
1142-150AWL	0-150mm/0-6"	±0.03mm	230mm	100mm	5mm	2mm	14.5mm
1142-200AWL	0-200mm/0-8"	±0.03mm	280mm	100mm	5mm	2mm	14.5mm
1142-300AWL	0-300mm/0-12"	±0.04mm	380mm	150mm	5mm	2mm	14.5mm
1142-500AWL	0-500mm/0-20"	±0.05mm	585mm	150mm	8mm	3mm	15mm
1142-5001AWL	0-500mm/0-20"	±0.05mm	585mm	200mm	8mm	3mm	15mm

DIGITAL DOUBLE HOOK DEPTH GAGES

DATA OUTPUT

- Non waterproof
- Resolution: 0.01mm/0.0005"
- Buttons: on/off, zero, mm/inch
- Automatic power off, move the digital unit to turn on power
- Meet DIN862
- Battery CR2032
- Made of stainless steel



1144-150A

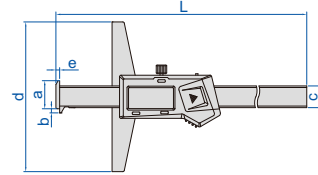
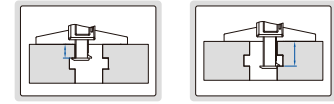

With data interface

Code	Range	Accuracy	L	d	a	b	c	e	Data output cable (optional)
1144-150A	0-150mm/0-6"	±0.03mm	233mm	100mm	21.5mm	3.5mm	14.5mm	2.5mm	7315-21 page 4, 7302-21 page 12
1144-200A	0-200mm/0-8"	±0.03mm	283mm	100mm	21.5mm	3.5mm	14.5mm	2.5mm	7315-21 page 4, 7302-21 page 12
1144-300A	0-300mm/0-12"	±0.03mm	383mm	150mm	21.5mm	3.5mm	14.5mm	2.5mm	7315-21 page 4, 7302-21 page 12
1144-500A	0-500mm/0-20"	±0.05mm	585mm	150mm	25mm	5mm	15mm	3mm	7315-22 page 4, 7302-22 page 12
1144-5001A	0-500mm/0-20"	±0.05mm	585mm	200mm	25mm	5mm	15mm	3mm	7315-22 page 4, 7302-22 page 12
1144-1000A	0-1000mm/0-40"	±0.07mm	1188mm	150mm	32mm	7mm	18mm	4mm	7315-22 page 4, 7302-22 page 12
1144-10001A	0-1000mm/0-40"	±0.07mm	1188mm	200mm	32mm	7mm	18mm	4mm	7315-22 page 4, 7302-22 page 12
1144-10002A	0-1000mm/0-40"	±0.07mm	1188mm	250mm	32mm	7mm	18mm	4mm	7315-22 page 4, 7302-22 page 12

Built-in wireless (receiver code 7315-2/3/6/7/8/9 is required)

Code	Range	Accuracy	L	d	a	b	c	e
1144-150AWL	0-150mm/0-6"	±0.03mm	233mm	100mm	21.5mm	3.5mm	14.5mm	2.5mm
1144-200AWL	0-200mm/0-8"	±0.03mm	283mm	100mm	21.5mm	3.5mm	14.5mm	2.5mm
1144-300AWL	0-300mm/0-12"	±0.03mm	383mm	150mm	21.5mm	3.5mm	14.5mm	2.5mm
1144-500AWL	0-500mm/0-20"	±0.05mm	585mm	150mm	25mm	5mm	15mm	3mm
1144-5001AWL	0-500mm/0-20"	±0.05mm	585mm	200mm	25mm	5mm	15mm	3mm

DIGITAL DOUBLE HOOK DEPTH GAGE

DATA OUTPUT

- Non waterproof
- Resolution: 0.01mm/0.0005"
- Buttons: on/off, zero, mm/inch, ABS/INC, data hold, TOL, set
- ABS/INC is for absolute and incremental measurement
- TOL is for tolerance measurement
- Made of stainless steel
- LR44 battery, data output
- Supplied with gage block for zero setting
- Optional accessory: extension base, wireless transmitter (code 7315-1150 page 6), data output cable (code 7302-SPC7 page 13, keyboard format)

Code	Range	Accuracy
1540-300	0-300mm/0-12"	±0.04mm



1540-300

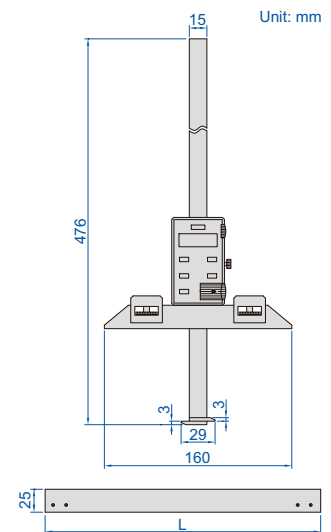

Extension base (optional)

Code	L
1540-L300	300mm
1540-L400	400mm
1540-L500	500mm
1540-L600	600mm
1540-L800	800mm

gage block for zero setting (included)

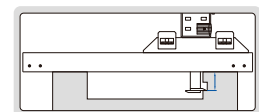
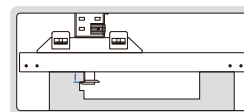

MEASURE WIDTH AND DEPTH OF GROOVES INSIDE BORE

MEASURE DEPTH OF SMALL HOLES (>Ø4mm)

DATA OUTPUT

DIGITAL DEPTH GAGES WITH ROUND DEPTH BAR

- Non waterproof
- Resolution: 0.01mm/0.0005"
- Supplied with three interchangeable points (flat, spherical, disk)
- Buttons: on/off, set, mm/inch, preset (+, -)
- Automatic power off, move the digital unit to turn on power
- Battery CR2032
- Made of stainless steel
- Optional accessory: extension base (code 6141, for 1148-120, 1148-120WL, 1148-200, 1148-200WL, 1148-300 and 1148-300WL)

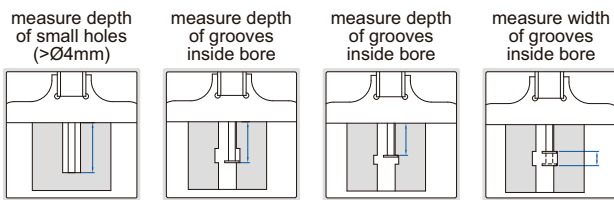
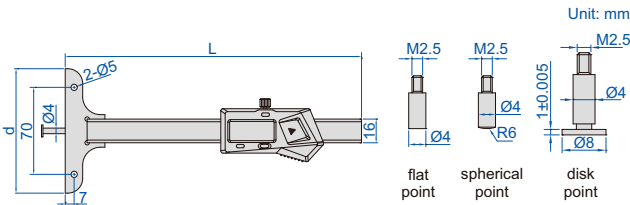

With data interface (data output cable code 7315-21 page 4, 7302-21 page 12, optional)

Code	Range *	Accuracy	L	d	Remark
1148-100S	0-100mm/0-4"	±0.02mm	200mm	45mm	
1148-100	0-100mm/0-4"	±0.02mm	200mm	85mm	
1148-120	0-120mm/0-4.7"	±0.03mm	300mm	101mm	one-hand use, with mounting holes for extension base
1148-200	0-200mm/0-8"	±0.03mm	300mm	101mm	with mounting holes for extension base
1148-300	0-300mm/0-12"	±0.04mm	400mm	101mm	with mounting holes for extension base

one-hand use of 1148-120 and 1148-120WL



extension base for 1148-120, 1148-120WL, 1148-200, 1148-200WL, 1148-300 and 1148-300WL (optional)



Built-in wireless (receiver code 7315-2/3/6/7/8/9 is required)

Code	Range *	Accuracy	L	d	Remark
1148-100SWL	0-100mm/0-4"	±0.02mm	200mm	45mm	
1148-100WL	0-100mm/0-4"	±0.02mm	200mm	85mm	
1148-120WL	0-120mm/0-4.7"	±0.03mm	300mm	101mm	one-hand use, with mounting holes for extension base
1148-200WL	0-200mm/0-8"	±0.03mm	300mm	101mm	with mounting holes for extension base
1148-300WL	0-300mm/0-12"	±0.04mm	400mm	101mm	with mounting holes for extension base

1148-P103 (optional), measure width of bottom grooves inside blind hole

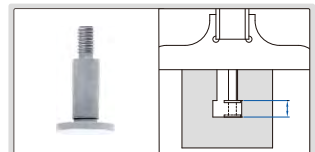

*When disk points are used, the range is reduced by 10mm

OPTIONAL DISK POINTS

Code	Description	H	Remark
1148-P101	0.5mm disk point	0.5±0.005mm	for narrow grooves
1148-P102	0.7mm disk point	0.7±0.005mm	for narrow grooves
1148-P103	1mm disk point	1±0.005mm	for grooves inside blind hole
1148-P104	0.5mm disk point	0.5±0.005mm	for grooves inside blind hole

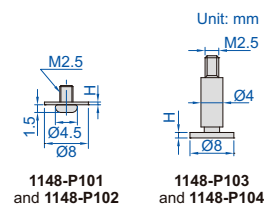

DIGITAL POINT DEPTH GAGES

DATA
OUTPUT

3

- Non waterproof
- Resolution: 0.01mm/0.0005"
- Buttons: on/off, zero, mm/inch
- Automatic power off, move the digital unit to turn on power
- Meet DIN862
- Battery CR2032
- Made of stainless steel



1143-200A

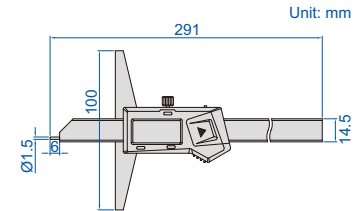

With data interface (data output cable code 7315-21 page 4, 7302-21 page 12, optional)

Code	Range	Accuracy
1143-200A	0-200mm/0-8"	±0.03mm

Built-in wireless (receiver code 7315-2/3/6/7/8/9 is required)

Code	Range	Accuracy
1143-200AWL	0-200mm/0-8"	±0.03mm

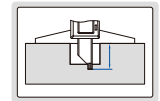

DIAL DEPTH GAGES

SHOCK
PROOF

- Shockproof dial indicator
- Made of stainless steel



1340-150

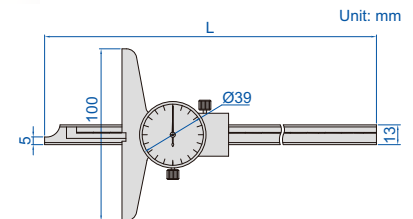

Code	Range	Graduation	Accuracy	L
1340-150	0-150mm	0.02mm	±0.03mm	232mm
1340-200	0-200mm	0.02mm	±0.03mm	282mm
1340-300	0-300mm	0.02mm	±0.04mm	382mm

VERNIER DEPTH GAGES (STANDARD TYPE)

POPULAR
MODEL

- Made of stainless steel
- Satin chrome plated reading surface

Graduation 0.05mm

Code	Range	Accuracy	L	d
1240-150	0-150mm	±0.05mm	245mm	100mm
1240-200	0-200mm	±0.05mm	282mm	100mm
1240-300	0-300mm	±0.08mm	382mm	100mm
1240-500	0-500mm	±0.09mm	585mm	150mm

Graduation 0.02mm

Code	Range	Accuracy	L	d
1240-1501	0-150mm	±0.03mm	245mm	100mm
1240-2001	0-200mm	±0.03mm	282mm	100mm
1240-3001	0-300mm	±0.04mm	382mm	100mm
1240-5001	0-500mm	±0.05mm	585mm	150mm



1240-2001

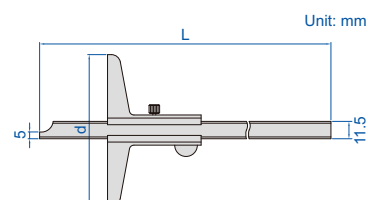

VERNIER DEPTH GAGES

WITH MOUNTING HOLES FOR EXTENSION BASE



- Made of stainless steel
- Satin chrome plating finish on reading surface
- Optional accessory: extension base (code **6141**)

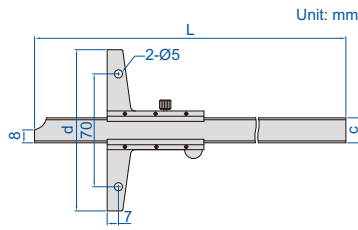

1247-2001

Graduation 0.05mm

Code	Range	Accuracy
1247-150	0-150mm	±0.05mm
1247-200	0-200mm	±0.05mm
1247-300	0-300mm	±0.08mm
1247-600	0-600mm	±0.10mm
1247-1000	0-1000mm	±0.15mm

Graduation 0.02mm

Code	Range	Accuracy
1247-1501	0-150mm	±0.03mm
1247-2001	0-200mm	±0.03mm
1247-3001	0-300mm	±0.04mm
1247-6001	0-600mm	±0.05mm
1247-1001	0-1000mm	±0.07mm

Range	L	c	d
0-150mm	240mm	16mm	100mm
0-200mm	290mm	16mm	100mm
0-300mm	390mm	16mm	100mm
0-600mm	704mm	16mm	150mm
0-1000mm	1124mm	16mm	200mm

WITH MOUNTING HOLES FOR EXTENSION BASE

- With fine adjustment
- Made of stainless steel
- Satin chrome plating finish on reading surface
- Optional accessory: extension base (code **6141**)

Graduation 0.05mm

Code	Range	Accuracy
1249-150	0-150mm	±0.05mm
1249-200	0-200mm	±0.05mm
1249-300	0-300mm	±0.08mm

Graduation 0.02mm

Code	Range	Accuracy
1249-1501	0-150mm	±0.03mm
1249-2001	0-200mm	±0.03mm
1249-3001	0-300mm	±0.04mm

Range	L	c	d
0-150mm	256mm	16mm	100mm
0-200mm	306mm	16mm	100mm
0-300mm	406mm	16mm	100mm



VERNIER DEPTH GAGES WITH FINE ADJUSTMENT



1249-1501

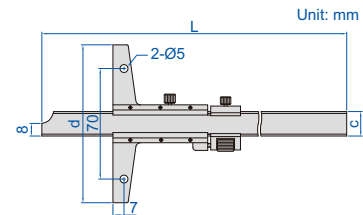

WITH MOUNTING HOLES FOR EXTENSION BASE

- Made of stainless steel
- Satin chrome plating finish on reading surface
- Optional accessory: extension base (code **6141**)

Graduation 0.05mm

Code	Range	Accuracy	L
1248-150	0-150mm	±0.05mm	266mm
1248-200	0-200mm	±0.05mm	316mm
1248-300	0-300mm	±0.08mm	416mm

Graduation 0.02mm

Code	Range	Accuracy	L
1248-1501	0-150mm	±0.03mm	266mm
1248-2001	0-200mm	±0.03mm	316mm
1248-3001	0-300mm	±0.04mm	416mm

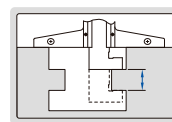
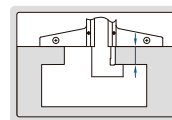
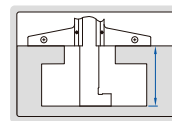

VERNIER HOOK DEPTH GAGES



1248-1501

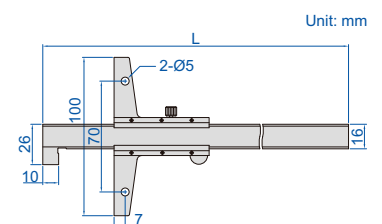

VERNIER HOOK DEPTH GAGE

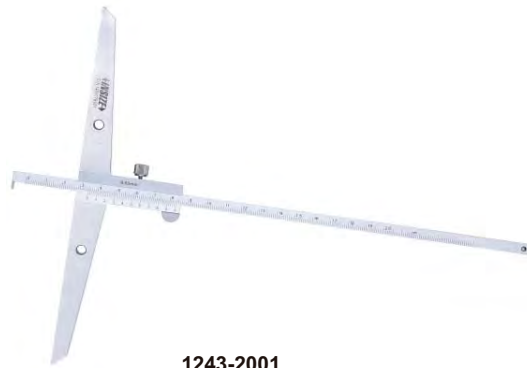

1243-2001

- Graduation 0.02mm
- Made of stainless steel
- Satin chrome plating finish on reading surface

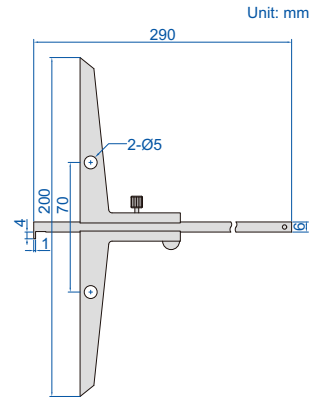

Unit: mm

Code	Range	Accuracy
1243-2001	0-200mm	±0.04mm

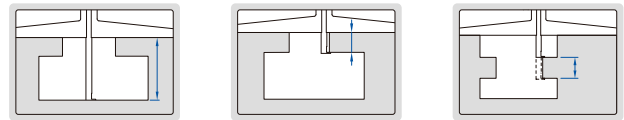

EXTENSION BASES



6141-260

- Supplied with two screws
- Made of stainless steel
- Suitable for depth gages series 1147, 1148, 1247, 1248 and 1249

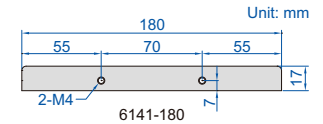
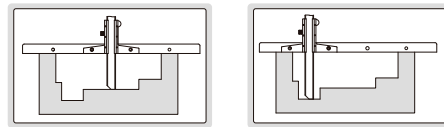

6141-180

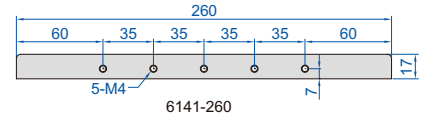

6141-260

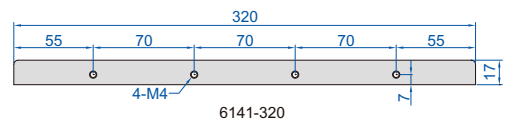

6141-320

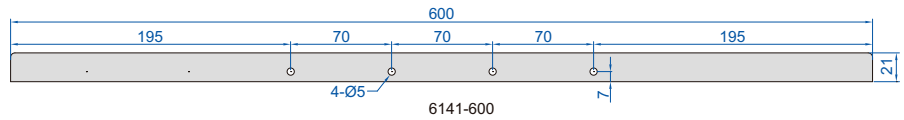

6141-600

Code	Length
6141-180	180mm
6141-260	260mm
6141-320	320mm
6141-600	600mm

MINI VERNIER DEPTH GAGE

- Graduation: 0.1mm
- Made of stainless steel



1244-30

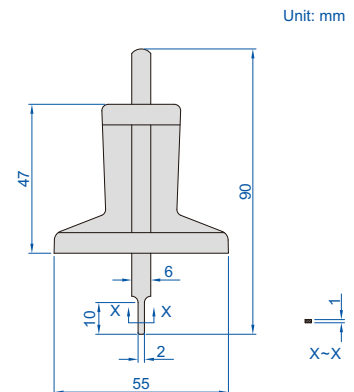

Unit: mm

Code	Range	Accuracy
1244-30	0-30mm	±0.10mm

DATA OUTPUT

MINI DIGITAL DEPTH GAGES WITH ROUND BAR

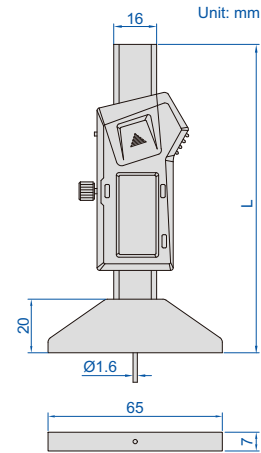

- Non waterproof
- Measure depth of small groove and hole
- Resolution: 0.01mm/0.0005"
- Buttons: on/off, set, mm/inch, preset (+,-)
- Automatic power off, move the digital unit to turn on power
- Battery CR2032
- Made of stainless steel

1140-25

With data interface (data output cable code 7315-21 page 4, 7302-21 page 12, optional)

Code	Range	Accuracy	L
1140-25	0-25mm/0-1"	±0.02mm	114mm
1140-50	0-50mm/0-2"	±0.02mm	140mm
1140-100	0-100mm/0-4"	±0.02mm	190mm
1140-150	0-150mm/0-6"	±0.03mm	236mm

Built-in wireless (receiver code 7315-2/3/6/7/8/9 is required)

Code	Range	Accuracy	L
1140-25WL	0-25mm/0-1"	±0.02mm	114mm
1140-50WL	0-50mm/0-2"	±0.02mm	140mm
1140-100WL	0-100mm/0-4"	±0.02mm	190mm
1140-150WL	0-150mm/0-6"	±0.03mm	236mm

MINI DIGITAL DEPTH GAGES

DATA OUTPUT

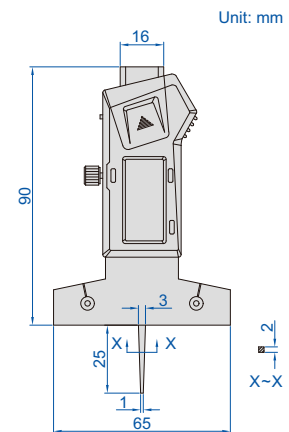

- Non waterproof
- Measure depth of small groove and hole, also measure depth of tire tread
- Resolution: 0.01mm/0.0005"
- Buttons: on/off, zero, mm/inch
- Supplied with zero set surface
- Automatic power off, move the digital unit to turn on power
- Battery CR2032
- Made of stainless steel

1145-25A

With data interface (data output cable code 7315-21 page 4, 7302-21 page 12, optional)

Code	Range	Accuracy
1145-25A	0-25mm/0-1"	±0.03mm

Built-in wireless (receiver code 7315-2/3/6/7/8/9 is required)

Code	Range	Accuracy
1145-25AWL	0-25mm/0-1"	±0.03mm

DIAL DEPTH GAGES

3

- Accuracy: $\pm 0.017\text{mm}$
- Stainless steel base
- Pointed tip



2343-102

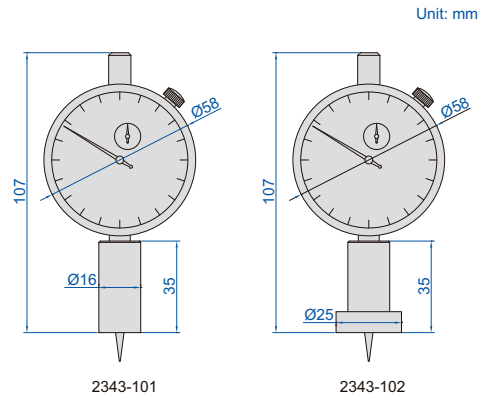

Unit: mm

Code	Range	Dial indicator stroke	Dial indicator graduation	Base
2343-101	0-10mm	10mm	0.01mm	Ø16mm
2343-102	0-10mm	10mm	0.01mm	Ø25mm

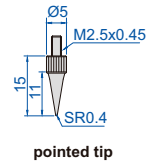

pointed tip

DIGITAL DEPTH GAGES

DATA OUTPUT

- Button function: on/off, zero, mm/inch, ABS, data preset, change measuring direction
- CR2032 battery, automatic power off (time is adjustable)
- Data output
- Stainless steel base
- Pointed tip
- Optional accessory: data output cable (code 7315-50M page 5, 7302-40M page 13)



2142-102

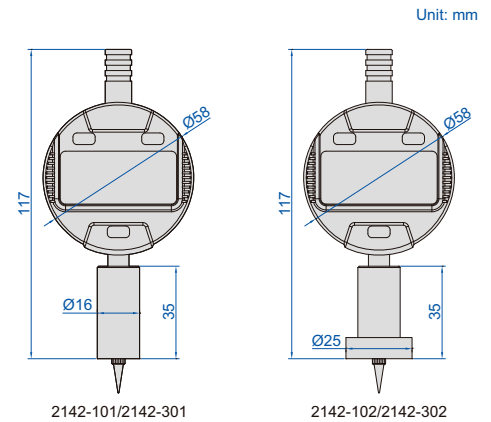

Unit: mm

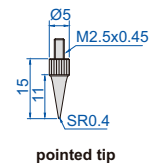

pointed tip

Code	Range	Digital indicator stroke	Digital indicator resolution	Accuracy	Base
2142-101	0-12.7mm/0-0.5"	12.7mm/0.5"	0.01mm/0.0005"	$\pm 20\mu\text{m}$	Ø16mm
2142-102	0-12.7mm/0-0.5"	12.7mm/0.5"	0.01mm/0.0005"	$\pm 20\mu\text{m}$	Ø25mm
2142-301	0-12.7mm/0-0.5"	12.7mm/0.5"	0.001mm/0.00005"	$\pm 5\mu\text{m}$	Ø16mm
2142-302	0-12.7mm/0-0.5"	12.7mm/0.5"	0.001mm/0.00005"	$\pm 5\mu\text{m}$	Ø25mm

DIAL DEPTH GAGE

- Accuracy: $\pm 0.017\text{mm}$
- Stainless steel base
- Supplied with pointed tip and ball tip



2341-101A

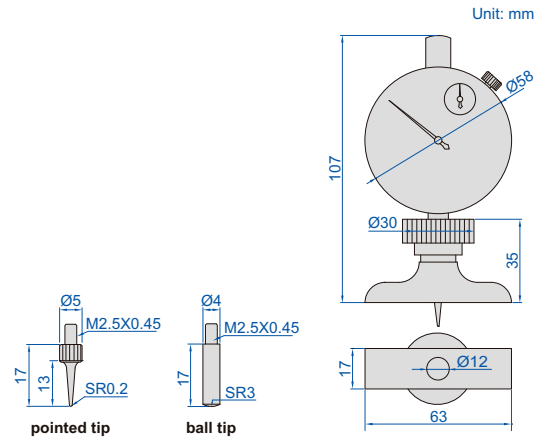

Code	Range	Dial indicator stroke	Dial indicator graduation
2341-101A	0-10mm	10mm	0.01mm

DIAL DEPTH GAGES



2342-202

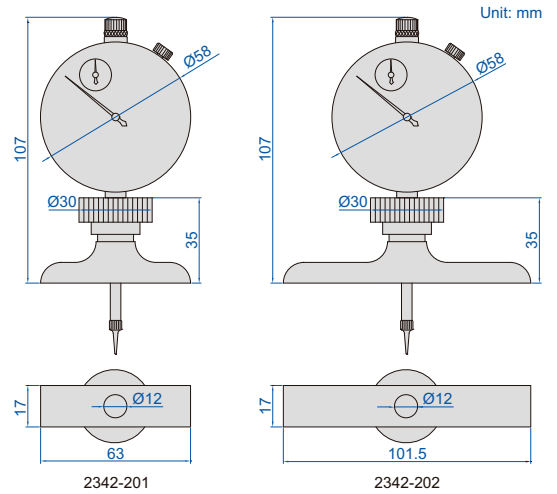

2141-10 (optional),
can be customized
according to workpieces

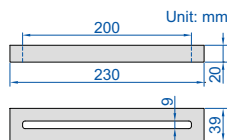

- Dial indicator graduation: 0.01mm
- Accuracy: $\pm 0.03\text{mm}$
- Stainless steel base
- Extension rods: 25mm (1 pc), 50mm (1 pc), 75mm (1 pc), 100mm (2 pcs)
- Supplied with pointed tip and ball tip
- Optional accessory: granite extension holder (code 2141-10)

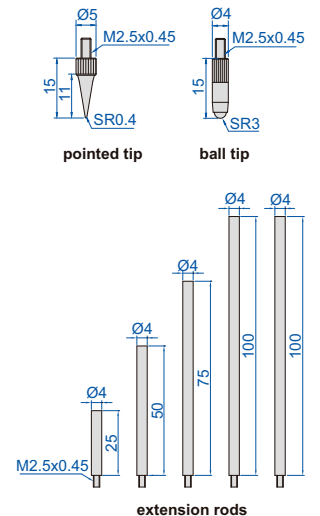
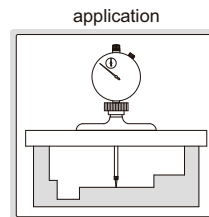

Code	Range	Dial indicator stroke	Base
2342-201	0-300mm	30mm	63x17mm
2342-202	0-300mm	30mm	101.5x17mm

DIGITAL DEPTH GAGES

DATA OUTPUT

3



2141-202A

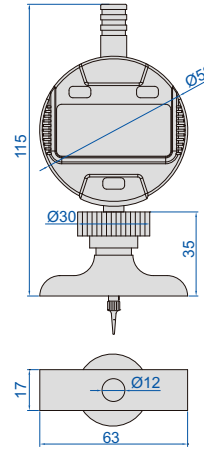

2141-201A/2141-301

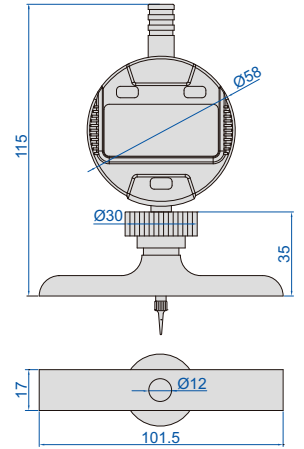

2141-202A/2141-302

Unit: mm

- Button function: on/off, zero, mm/inch, ABS, data preset, change measuring direction
- CR2032 battery, automatic power off (time is adjustable)
- Data output
- Stainless steel base
- Extension rods: 12.5mm (1 pc), 25mm (1 pc), 50mm (1 pc), 75mm (1 pc), 100mm (2 pcs)
- Supplied with pointed tip and ball tip
- Optional accessory: data output cable (code 7315-50M page 5, 7302-40M page 13), granite extension holder (code 2141-10)

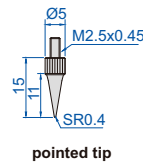

pointed tip

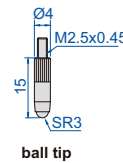

ball tip

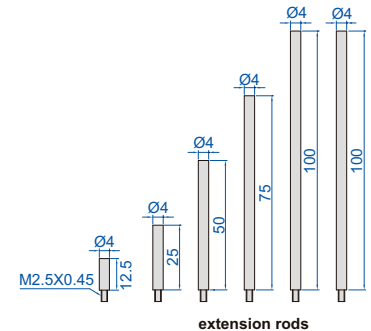

extension rods



2141-10 (optional), can be customized according to workpieces

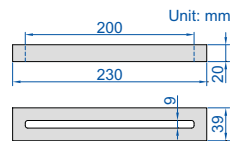

Unit: mm

application

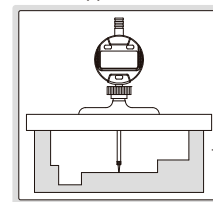

Code	Range	Digital indicator stroke	Digital indicator resolution	Accuracy	Base
2141-201A	0-300mm/0-12"	12.7mm/0.5"	0.01mm/0.0005"	±20µm	63x17mm
2141-202A	0-300mm/0-12"	12.7mm/0.5"	0.01mm/0.0005"	±20µm	101.5x17mm
2141-301	0-300mm/0-12"	12.7mm/0.5"	0.001mm/0.00005"	±5µm	63x17mm
2141-302	0-300mm/0-12"	12.7mm/0.5"	0.001mm/0.00005"	±5µm	101.5x17mm

DATA OUTPUT

DIGITAL GROOVE GAGES

3



2145-202

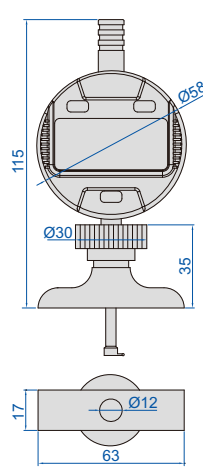

2145-201/2145-301

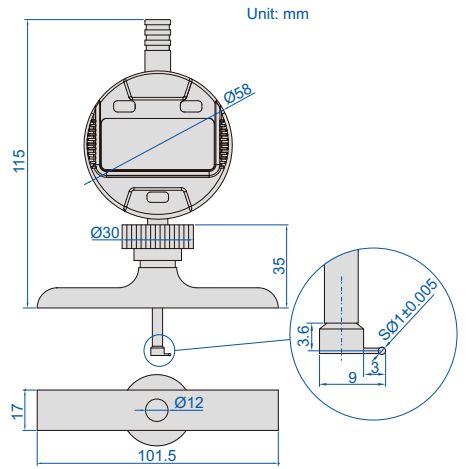

2145-202/2145-302

- Button function: on/off, zero, mm/inch, absolute/incremental measurement, data preset, change measuring direction
- CR2032 battery, automatic power off (time is adjustable)
- Data output
- Stainless steel base
- Supplied with extension rods: 12.5mm (1 pc), 25mm (1 pc), 50mm (1 pc)
- Supplied with groove point
- Optional accessory: data output cable (code **7315-50M** page 5, **7302-40M** page 13)

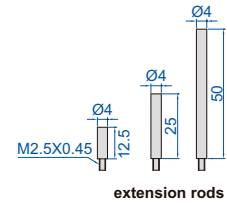

extension rods

Code	Range (a)	Digital indicator stroke (b)	Digital indicator resolution	Accuracy	Base
2145-201	0-85mm/0-3.35"	12.7mm/0.5"	0.01mm/0.0005"	±20µm	63x17mm
2145-202	0-85mm/0-3.35"	12.7mm/0.5"	0.01mm/0.0005"	±20µm	101.5x17mm
2145-301	0-85mm/0-3.35"	12.7mm/0.5"	0.001mm/0.00005"	±5µm	63x17mm
2145-302	0-85mm/0-3.35"	12.7mm/0.5"	0.001mm/0.00005"	±5µm	101.5x17mm

measure width (b) and depth (a) of groove

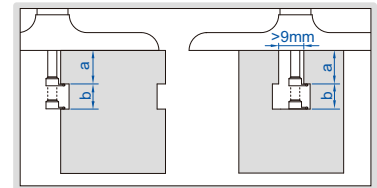

DATA OUTPUT

DIGITAL DEPTH GAGE (60° KNIFE EDGE BASE)

- Button function: on/off, zero, inch/mm, ABS, data preset, change measuring direction
- CR2032 battery, automatic power off (time is adjustable)
- Data output
- Stainless steel base with 60° knife edge
- Optional accessory: data output cable (code **7315-50M** page 5, **7302-40M** page 13)



front view



side view

2143-101

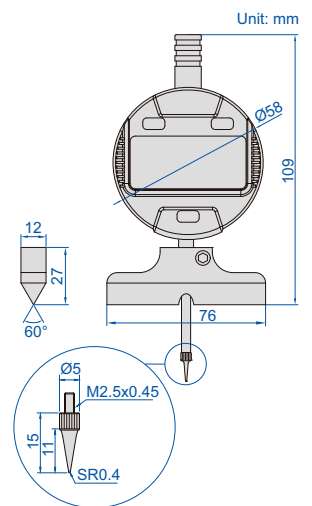

Code	Range	Digital indicator stroke	Digital indicator resolution	Accuracy
2143-101	0-12.7mm/0-0.5"	12.7mm/0.5"	0.01mm/0.0005"	±20µm

DIGITAL DEPTH MICROMETERS

IP65
WATERPROOF

DATA
OUTPUT

3

- Resolution: 0.001mm/0.00005"
- Micrometer head accuracy: $\pm 3\mu\text{m}$
- Rod accuracy: $\pm(2+L/75)\mu\text{m}$, L is the measuring range in mm
- Button function: on/off, set, mm/inch, data transmit
- IP65 dust/waterproof
- Data output
- Automatic power off
- Rods with flat end
- Ratchet stop
- Optional accessory: data output cable (code 7315-31 page 4, 7302-31 page 12)

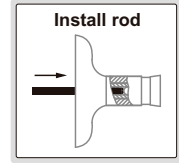

3540-50

Code	Range	Rods	L
3540-25	0-25mm/0-1"	1 pc	101.5mm
3540-50	0-50mm/0-2"	2 pcs	101.5mm
3540-100	0-100mm/0-4"	4 pcs	101.5mm
3540-150	0-150mm/0-6"	6 pcs	101.5mm
3540-300	0-300mm/0-12"	12 pcs	101.5mm
3540-B25	0-25mm/0-1"	1 pc	63mm
3540-B50	0-50mm/0-2"	2 pcs	63mm
3540-B100	0-100mm/0-4"	4 pcs	63mm
3540-B150	0-150mm/0-6"	6 pcs	63mm
3540-B300	0-300mm/0-12"	12 pcs	63mm

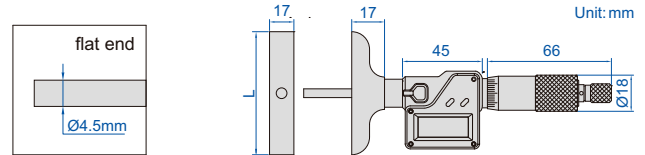

DEPTH MICROMETERS

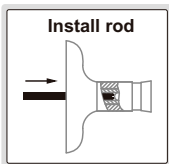

- Meet DIN863-2
- Graduation: 0.01mm
- Micrometer head accuracy: $\pm 3\mu\text{m}$
- Rod accuracy: $\pm(2+L/75)\mu\text{m}$, L is the measuring range in mm
- Rods with flat or spherical end
- Ratchet stop

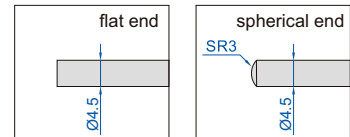
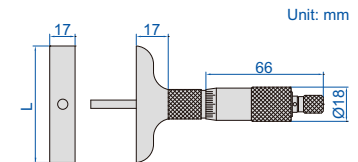

3240-100

Flat end

Code	Range	Rods	L
3240-25	0-25mm	1 pc	101.5mm
3240-50	0-50mm	2 pcs	101.5mm
3240-75	0-75mm	3 pcs	101.5mm
3240-100	0-100mm	4 pcs	101.5mm
3240-150	0-150mm	6 pcs	101.5mm
3240-200	0-200mm	8 pcs	101.5mm
3240-300	0-300mm	12 pcs	101.5mm
3240-B25	0-25mm	1 pc	63mm
3240-B50	0-50mm	2 pcs	63mm
3240-B100	0-100mm	4 pcs	63mm
3240-B150	0-150mm	6 pcs	63mm
3240-B300	0-300mm	12 pcs	63mm

Spherical end

Code	Range	Rods	L
3240-25S	0-25mm	1 pc	101.5mm
3240-50S	0-50mm	2 pcs	101.5mm
3240-100S	0-100mm	4 pcs	101.5mm
3240-150S	0-150mm	6 pcs	101.5mm
3240-300S	0-300mm	12 pcs	101.5mm
3240-B25S	0-25mm	1 pc	63mm
3240-B50S	0-50mm	2 pcs	63mm
3240-B100S	0-100mm	4 pcs	63mm
3240-B150S	0-150mm	6 pcs	63mm
3240-B300S	0-300mm	12 pcs	63mm

- Meet DIN863-2
- Graduation: 0.01mm
- Micrometer head accuracy: $\pm 3\mu\text{m}$
- Rod accuracy: $\pm (2+L/75)\mu\text{m}$, L is the measuring range in mm
- Rods with flat end
- Ratchet stop

DEPTH MICROMETERS

Code	Range	Rods	L
3241-25	0-25mm	1 pc	101.5mm
3241-50	0-50mm	2 pcs	101.5mm
3241-75	0-75mm	3 pcs	101.5mm
3241-100	0-100mm	4 pcs	101.5mm
3241-150	0-150mm	6 pcs	101.5mm
3241-200	0-200mm	8 pcs	101.5mm
3241-300	0-300mm	12 pcs	101.5mm
3241-B25	0-25mm	1 pc	63mm
3241-B50	0-50mm	2 pcs	63mm
3241-B100	0-100mm	4 pcs	63mm
3241-B150	0-150mm	6 pcs	63mm
3241-B300	0-300mm	12 pcs	63mm

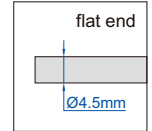

3241-100

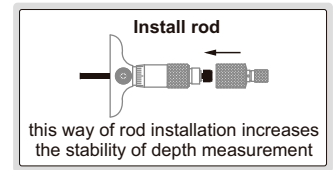
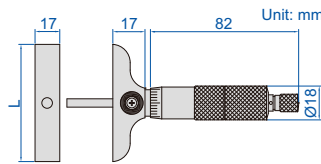

CYLINDER GAGE BLOCKS FOR DEPTH MICROMETERS

Code	Length (L)
4179-25*	25mm
4179-50*	50mm
4179-75*	75mm
4179-100*	100mm
4179-125*	125mm
4179-150*	150mm
4179-175*	175mm
4179-200*	200mm
4179-225*	225mm
4179-250*	250mm
4179-275*	275mm

*Supplied with manufacturer inspection certificate



4179-25

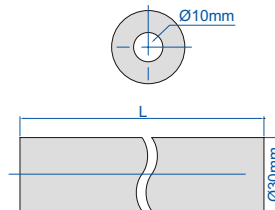

application



- Made of special alloy steel, hardness HRC64, high stability, wear resistance and easy combination
- Meet ISO3650 grade 1



DEPTH MICROMETER CHECKERS

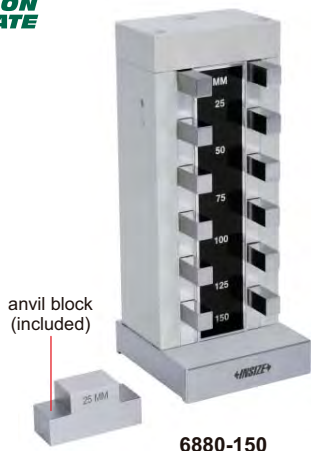

6880-150



application

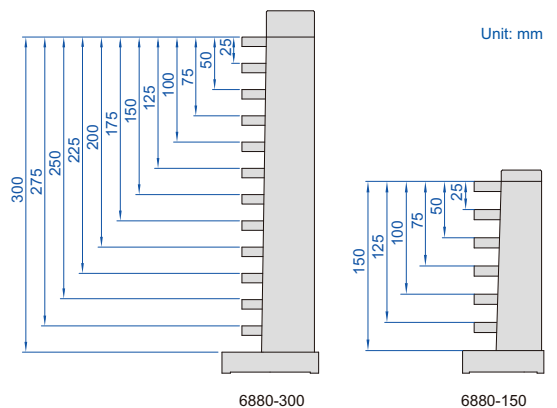

6880-300

6880-150

Code	Size	Range (mm)	Accuracy
6880-150*	0-150mm	25, 50, 75, 100, 125, 150	$\pm 2\mu\text{m}$
6880-300*	0-300mm	25, 50, 75, 100, 125, 150, 175, 200, 225, 250, 275, 300	$\pm 3\mu\text{m}$

*Supplied with manufacturer inspection certificate

- To check depth micrometers and set zero
- Constructed with steel gage blocks
- Supplied with anvil block



Digital Height Gages
Page 81-83



Dial Indicator Stands
Page 83



Height Gages
Page 84-88



Height Gage Checkers
Page 88



DATA
OUTPUT

HIGH PRECISION DIGITAL HEIGHT GAGES

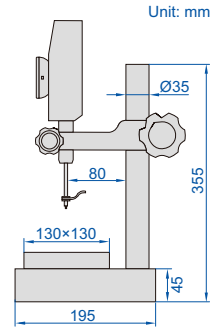
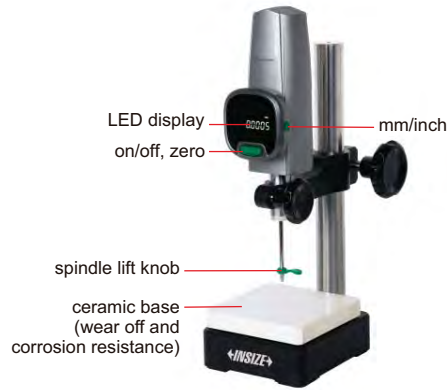

1155-505



power supplied by charge pal



data transmitted to Excel without software; short press the foot switch to transmit data, long press to zero

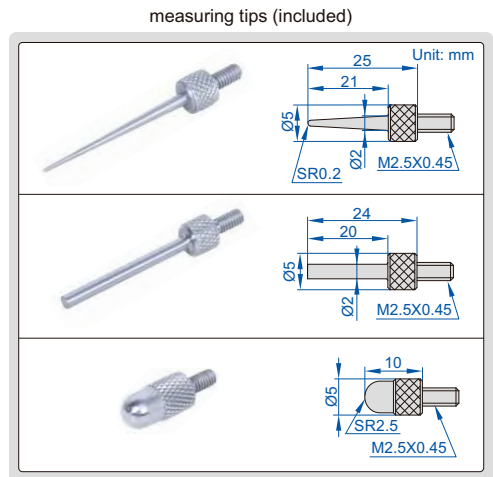

- High stability, high precision, high response speed (5000mm/s)
- High brightness LED display
- Ceramic base flatness: 1µm

Code	Range	Resolution	Accuracy (20°C)	Measuring force	Output	Power supply
1155-505	0~50mm	0.5µm/0.00002" (can switch to: 1µm/0.00005")	1.5µm	0.8~1.2N	USB	5V/1A (adapter or charge pal)
1155-510	0~50mm	0.1µm/0.000005" (can switch to: 1µm/0.00005")	1µm	0.8~1.2N	USB	5V/1A (adapter or charge pal)

STANDARD DELIVERY

Main unit	1 pc
-----------	------

OPTIONAL ACCESSORY

Contact point	code 6282
Charge pal	1155-5-POB
Data output cable (including foot switch)	1155-5-FOS

DIGITAL HEIGHT GAGES

DATA
OUTPUT



4



1157-501

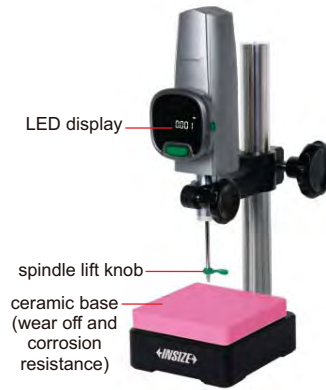
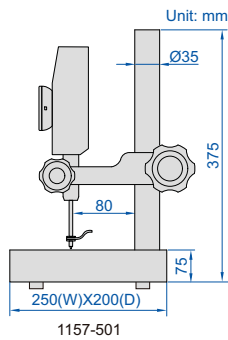

1157-502

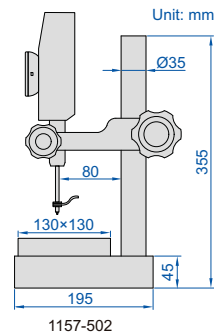

- Buttons: on/off, zero, mm/inch, mix/min/mix-min
- High response speed (5000mm/s)
- High brightness LED display



power supplied by charge pal



data transmitted to Excel without software;
short press the foot switch to transmit data,
long press to zero

measuring tips (included)

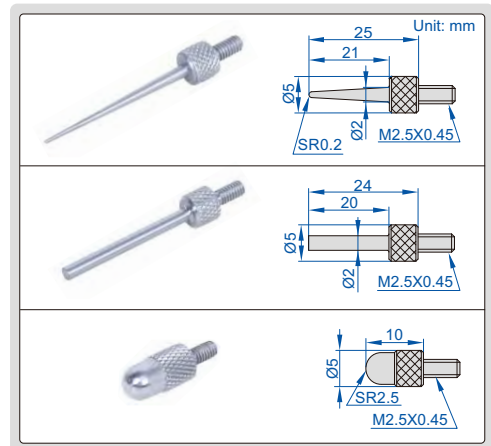

Code	Range	Resolution	Accuracy (20°C)	Measuring force	Output	Power supply	Base
1157-501	0~50mm	1µm/0.00005"	3µm	0.8~1.2N	USB	5V/1A (adapter or charge pal)	granite (flatness: 2µm)
1157-502	0~50mm	1µm/0.00005"	3µm	0.8~1.2N	USB	5V/1A (adapter or charge pal)	ceramic (flatness: 1µm)

OPTIONAL ACCESSORY

Contact point	code 6282
Charge pal	1155-5-POB
Data output cable (including foot switch)	1155-5-FOS

STANDARD DELIVERY

Main unit	1 pc
-----------	------

DATA OUTPUT

LARGE RANGE DIGITAL HEIGHT GAGE

4

- High stability, high precision, high response speed (5000mm/s)
- High brightness LED display
- Granite base flatness: 3µm

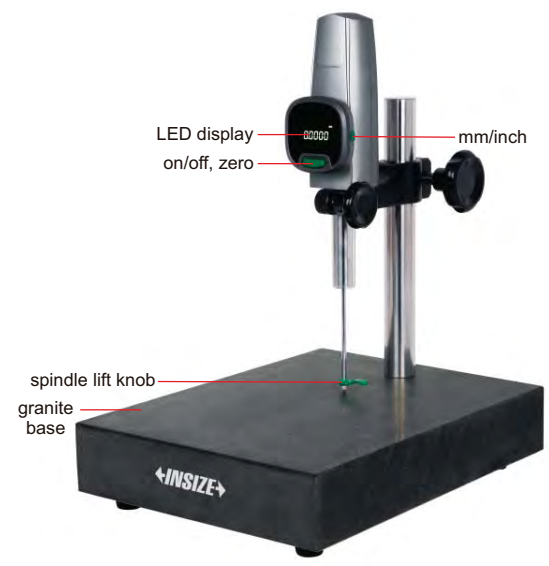
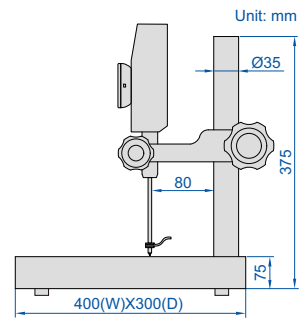

1158-100

measuring tips (included)

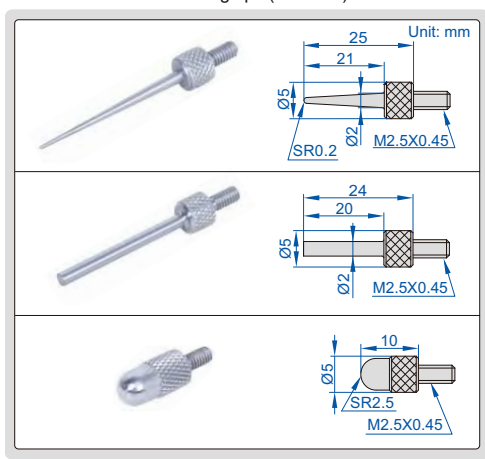

power supplied by charge pal



data transmitted to Excel without software; short press the foot switch to transmit data, long press to zero

Code	Range	Resolution	Accuracy (20°C)	Measuring force	Output	Power supply
1158-100	0~100mm	0.1µm/0.000005" (can switch to: 1µm/0.00005")	3µm	0.8~1.2N	USB	5V/1A (adapter or charge pal)

STANDARD DELIVERY

Main unit	1 pc
------------------	------

OPTIONAL ACCESSORY

Contact point	code 6282
Charge pal	1155-5-POB
Data output cable (including foot switch)	1155-5-FOS

DIAL INDICATOR STANDS

REFER TO PAGE 240-246 FOR DETAILS



6862-1001



6864-250T



6867-250

DIGITAL HEIGHT GAGES

DATA
OUTPUT

4

- Non waterproof
- Resolution: 0.01mm/0.0005"
- Buttons: on/off, zero, mm/inch, ABS/INC, data hold, TOL, set
- ABS/INC is for absolute and incremental measurement
- TOL is for tolerance measurement
- Carbide tipped scriber
- Made of stainless steel (except the base)
- LR44 battery, data output
- Supplied with dial test indicator holder
- Supplied with dust cover (except 1150-1500/2000)
- Optional accessory: wireless transmitter (code 7315-1150 page 6), data output cable (code 7302-SPC7 page 13, keyboard format), clamp for protractors (code 2372-CLAMP, for 1150-300)

scriber (included)

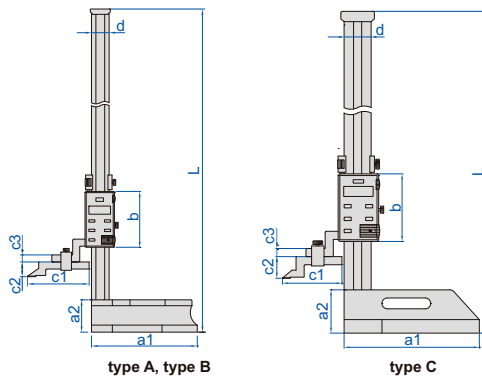
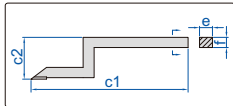

type A, type B

type C

clamp for protractors (optional)
for 1150-300

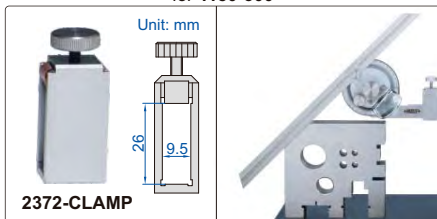

2372-CLAMP



1150-1000

1150-500

1150-300

dial test indicator holder (included)

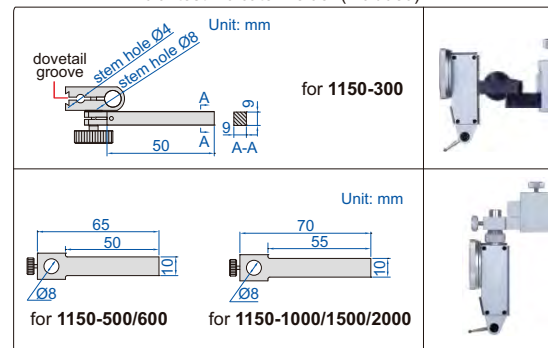

Code	Range	Type	Accuracy	L	a1	a2	b	c1	c2	c3	d	e	f
1150-300	0-300mm/0-12"	A	±0.04mm	485mm	138mm	45mm	95mm	80mm	30mm	10mm	28mm	9mm	9mm
1150-500	0-500mm/0-20"	B	±0.06mm	720mm	180mm	55mm	95mm	103mm	25mm	12mm	30mm	10mm	12mm
1150-600	0-600mm/0-24"	B	±0.06mm	820mm	180mm	55mm	95mm	103mm	25mm	12mm	30mm	10mm	12mm
1150-1000	0-1000mm/0-40"	C	±0.08mm	1275mm	250mm	80mm	125mm	110mm	39mm	15mm	50mm	10mm	15mm
1150-1500	0-1500mm/0-60"	C	±0.12mm	1790mm	280mm	80mm	125mm	110mm	39mm	15mm	50mm	10mm	15mm
1150-2000	0-2000mm/0-80"	C	±0.16mm	2290mm	280mm	80mm	125mm	110mm	39mm	15mm	50mm	10mm	15mm

DATA
OUTPUT

INSPECTION
CERTIFICATE

POPULAR
MODEL

DIGITAL HEIGHT GAGES WITH DRIVING WHEEL

4

- Non waterproof
- Resolution: 0.01mm/0.0005"
- Buttons: on/off, zero, mm/inch, preset +, preset -, ABS/INC
- Automatic power off, move the digital unit to turn on power
- Carbide tipped scriber
- Made of stainless steel
- Battery CR2032
- Data output
- Supplied with dust cover
- With dial test indicator holder
- Optional accessory: data output cable (code 7315-22 page 4, 7302-22 page 12), clamp for protractors (code 2372-CLAMP)

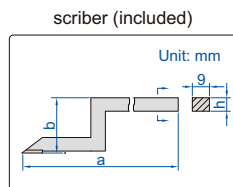
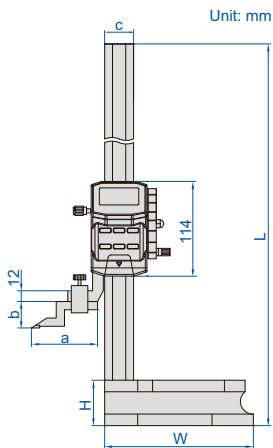

dial test indicator holder (included)

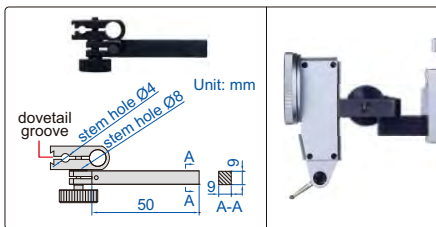

clamp for protractors (optional)

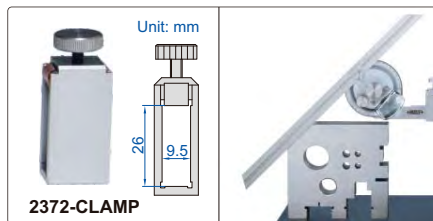

Code	Range	Accuracy	L	W	H	a	b	c	h
1156-300*	0-300mm/0-12"	±0.03mm	515mm	180mm	55mm	80mm	30mm	35mm	9mm
1156-600*	0-600mm/0-24"	±0.05mm	815mm	180mm	55mm	80mm	30mm	35mm	9mm
1156-1000*	0-1000mm/0-40"	±0.07mm	1220mm	265mm	70mm	92mm	48mm	40mm	12mm

*Supplied with manufacturer inspection certificate

DIGITAL HEIGHT GAGES

DATA OUTPUT

4

dial test indicator holder (included)

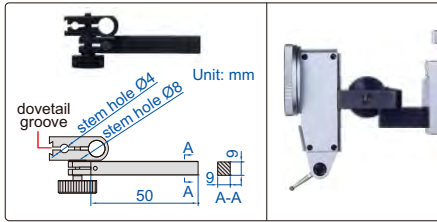

- Non waterproof
- Resolution: 0.01mm/0.0005"
- Buttons: on/off, zero, mm/inch, data hold, ABS/INC, preset
- ABS/INC is for absolute and incremental measurement
- Automatic power off, move the digital unit to turn on power
- Carbide tipped scriber
- Made of stainless steel
- Battery CR2032, data output
- With driving wheel
- With dial test indicator holder
- Supplied with dust cover
- Optional accessory: clamp for protractors (code **2372-CLAMP**), wireless transmitter (code **7315-1151** page 6), data output cable (code **7302-1151** page 13, keyboard format)



1151-300A

scriber (included)

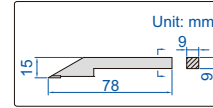

driving wheel on the back

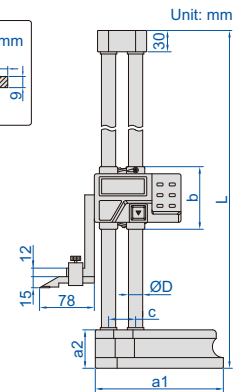

clamp for protractors (optional)

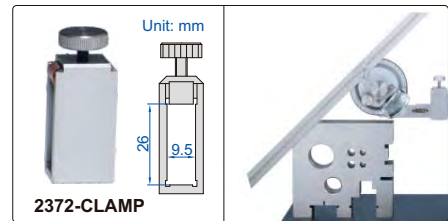

2372-CLAMP

Code	Range	Accuracy	L	a1	a2	b	c	ØD
1151-300A	0-300mm/0-12"	±0.04mm	475	135	43	84	33	15
1151-450A	0-450mm/0-18"	±0.05mm	660	180	54	88	38	20
1151-600A	0-600mm/0-24"	±0.05mm	810	180	54	88	38	20

DIAL HEIGHT GAGES

dial test indicator holder (included)

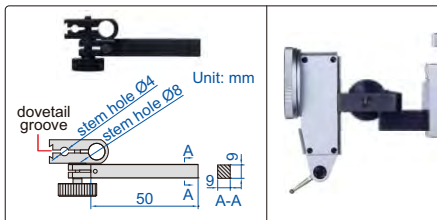

- Dial indicator graduation: 0.01mm
- One counter reads in the plus direction and another in the minus direction, so incremental measurement can be made in either direction
- Carbide tipped scriber
- Made of stainless steel (except the base)
- With driving wheel
- With dial test indicator holder
- Supplied with dust cover
- Optional accessory: clamp for protractors (code **2372-CLAMP**)



1351-300

scriber (included)

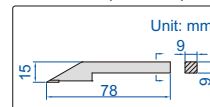

driving wheel on the back

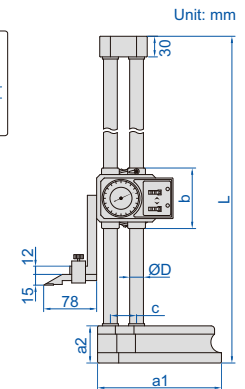

clamp for protractors (optional)

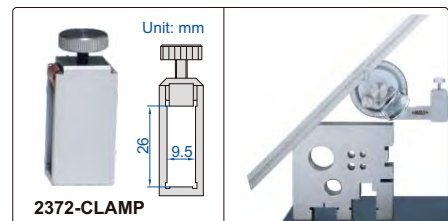

2372-CLAMP

Code	Range	Accuracy	L	a1	a2	b	c	ØD
1351-300	0-300mm	±0.04mm	475	135	43	84	33	15
1351-450	0-450mm	±0.05mm	660	180	54	88	38	20
1351-600	0-600mm	±0.05mm	810	180	54	88	38	20

DATA OUTPUT

- Non waterproof
- Resolution: 0.01mm/0.0005"
- Buttons: on/off, zero, mm/inch
- Automatic power off, move the digital unit to turn on power
- Carbide tipped scriber
- With fine adjustment
- Made of stainless steel
- Battery CR2032
- Optional accessory: dial test indicator holder (code **7151-CL1**)

1154-150

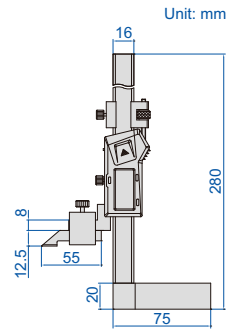

scraper (included)

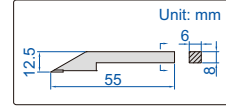

dial test indicator holder (optional)

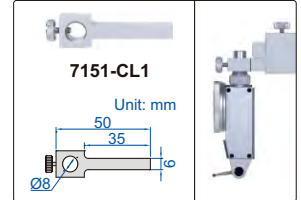

With data interface (data output cable code **7315-21** page 4, **7302-21** page 12, optional)

Code	Range	Accuracy
1154-150	0-150mm/0-6"	±0.03mm

Built-in wireless (receiver code **7315-2/3/6/7/8/9** is required)

Code	Range	Accuracy
1154-150WL	0-150mm/0-6"	±0.03mm

MINI VERNIER HEIGHT GAGES

- Graduation: 0.02mm/0.001"
- Carbide tipped scriber
- Made of stainless steel (except the base)
- Satin chrome plated scale
- Optional accessory: dial test indicator holder (code **7151-CL1**)

dial test indicator holder (optional)

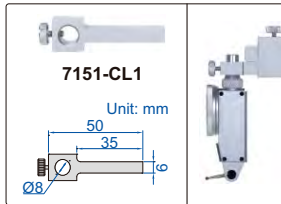

1253-200

scraper (included)

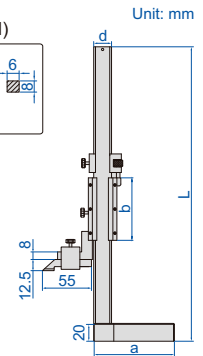
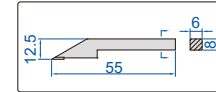

(mm)

Code	Range	Accuracy	L	a	b	d
1253-150	0-150mm/0-6"	±0.03mm	265	75	57	16
1253-200	0-200mm/0-8"	±0.03mm	325	90	70	20

VERNIER HEIGHT GAGES

- Graduation: 0.02mm/0.001"
- Adjustable main scale to set zero
- Carbide tipped scriber
- Made of stainless steel (except the base)
- Satin chrome plated scale
- Supplied with magnifier
- With fine adjustment
- Supplied with dust cover
- Optional accessory: dial test indicator holder (code **6293-6**), clamp for protractors (code **2372-CLAMP**)

scraper (included)

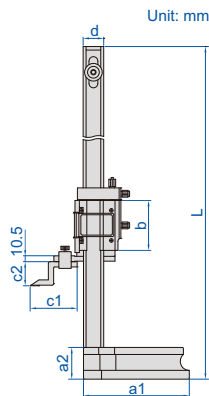
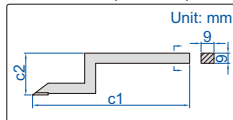

1250-300

(mm)

clamp for protractors (optional)

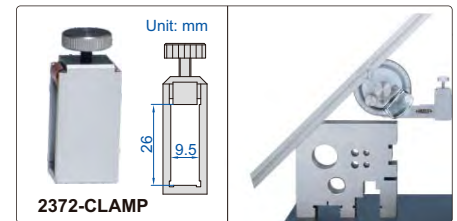

dial test indicator holder (optional)

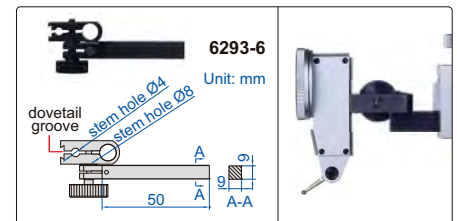

Code	Range	Accuracy	L	a1	a2	b	c1	c2	d
1250-300	0-300mm/0-12"	±0.04mm	545	135	43	75	80	30	28
1250-450	0-450mm/0-18"	±0.05mm	720	180	54	85	80	41	35
1250-600	0-600mm/0-24"	±0.05mm	870	180	54	85	80	41	35

VERNIER HEIGHT GAGES (BASIC TYPE)

- Graduation: 0.02mm/0.001"
- Carbide tipped scriber
- Made of stainless steel (except the base)
- Satin chrome plated scale
- With dial test indicator holder
- Supplied with dust cover

POPULAR MODEL

dial test indicator holder (included)

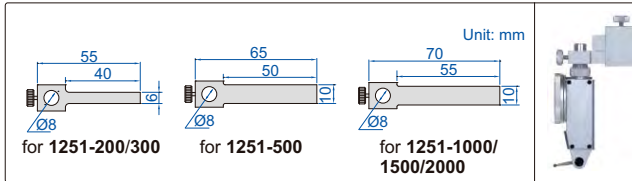

1251-200

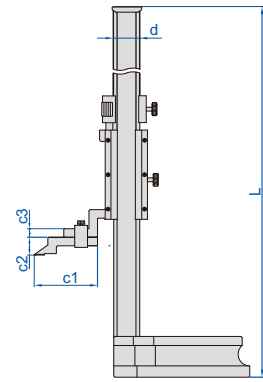

scriber (included)

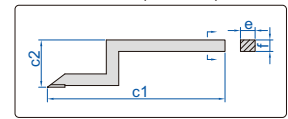

Code	Range	Accuracy	L	c1	c2	c3	d	e	f
1251-200	0-200mm/0-8"	±0.03mm	370	76	25	10	23	6	8
1251-300	0-300mm/0-12"	±0.04mm	470	76	25	10	23	6	8
1251-500	0-500mm/0-20"	±0.05mm	720	105	25	12	30	10	12
1251-1000	0-1000mm/0-40"	±0.07mm	1275	110	39	15	50	10	15
1251-1500	0-1500mm/0-60"	±0.11mm	1790	110	39	15	50	10	15
1251-2000	0-2000mm/0-80"	±0.14mm	2290	110	39	15	50	10	15

SCRIBERS FOR HEIGHT GAGES

- Carbide tipped



7150-SC3

Code	For height gages	Type	c1	c2	D	E
7150-SC2	1150-500, 1150-600	A	103mm	25mm	10mm	12mm
7150-SC3	1150-1000, 1150-1500, 1150-2000	A	110mm	39mm	10mm	15mm
7150-SC4	1351-300, 1351-450, 1351-600, 1151-300A, 1151-450A, 1151-600A	B	78mm	15mm	9mm	9mm
7150-SC6	1250-300, 1156-300, 1156-600, 1150-300	A	80mm	30mm	9mm	9mm
7150-SC7	1250-450, 1250-600	A	80mm	41mm	9mm	9mm
7150-SC9	1253-150, 1253-200, 1154-150	B	55mm	12.5mm	6mm	8mm
7150-SC10	1156-1000	A	92mm	48mm	9mm	12mm

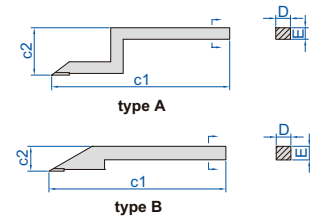

CALIPER/HEIGHT GAGE CHECKERS

REFER TO PAGE 296 FOR DETAILS

horizontal use



vertical use



6884-300



Carbon Fiber Comparison Gages
Page 90



Internal And External Diameter
Comparison Instruments
Page 91-92



Outside Diameter Measuring Stands
Page 93

CARBON FIBER COMPARISON GAGES

CARBON FIBER RODS, LIGHT WEIGHT, NOT EASY TO DEFORM, NO TEMPERATURE EXPAND, SUITABLE FOR THIN-WALL WORKPIECES AND LARGE-SIZE WORKPIECES

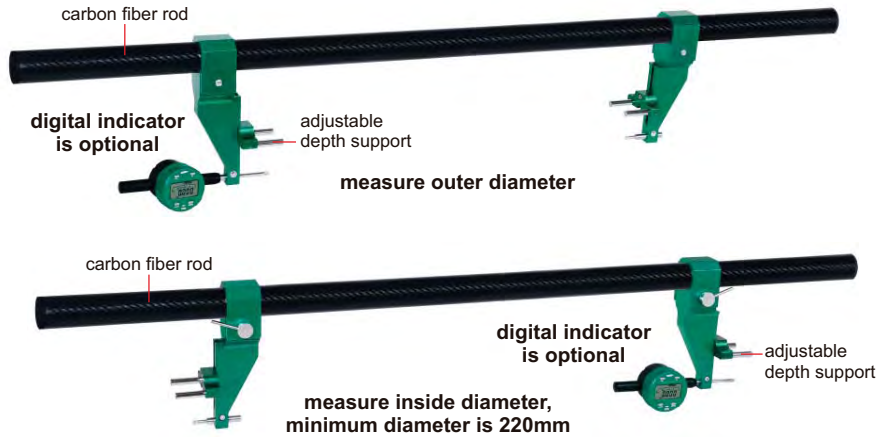

2931-D1000A

- Measure outer diameter, inside diameter, holes distance and cylindrical workpiece length
- Carbon fiber rods, light weight, not easy to deform, no temperature expand
- Optional accessory: cylinder gage blocks (code 4001), digital indicators (code 2138-25SP/2139-25SP/2103-25SP/2104-25SP)

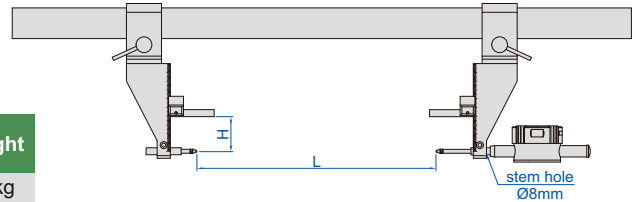

Code	Maximum measuring range (L)	Measuring depth (H)	Repeatability	Weight
2931-D1000A	1000mm	0-100mm	5µm	2.0kg
2931-D1000B	1000mm	0-200mm	10µm	2.3kg
2931-D1000C	1000mm	0-300mm	25µm	2.6kg
2931-D1500A	1500mm	0-100mm	8µm	2.3kg
2931-D1500B	1500mm	0-200mm	15µm	2.6kg
2931-D1500C	1500mm	0-300mm	30µm	2.9kg
2931-D2000A	2000mm	0-100mm	10µm	2.6kg
2931-D2000B	2000mm	0-200mm	20µm	2.9kg
2931-D2000C	2000mm	0-300mm	35µm	3.2kg
2931-D2500A	2500mm	0-100mm	12µm	2.9kg
2931-D2500B	2500mm	0-200mm	25µm	3.2kg
2931-D2500C	2500mm	0-300mm	50µm	3.5kg
2931-D3000A	3000mm	0-100mm	14µm	3.2kg
2931-D3000B	3000mm	0-200mm	30µm	3.5kg
2931-D3000C	3000mm	0-300mm	60µm	3.8kg
2931-D4000A	4000mm	0-100mm	16µm	3.8kg
2931-D4000B	4000mm	0-200mm	35µm	4.1kg
2931-D4000C	4000mm	0-300mm	65µm	4.4kg
2931-D5000A	5000mm	0-100mm	25µm	4.4kg
2931-D5000B	5000mm	0-200mm	40µm	4.7kg
2931-D5000C	5000mm	0-300mm	70µm	5.0kg
2931-D6000A	6000mm	0-100mm	28µm	8.4kg
2931-D6000B	6000mm	0-200mm	50µm	8.8kg
2931-D6000C	6000mm	0-300mm	80µm	9.2kg
2931-D7000A	7000mm	0-100mm	30µm	9.2kg
2931-D7000B	7000mm	0-200mm	55µm	9.6kg
2931-D7000C	7000mm	0-300mm	100µm	10kg
2931-D8000A	8000mm	0-100mm	32µm	10kg
2931-D8000B	8000mm	0-200mm	60µm	10.4kg
2931-D8000C	8000mm	0-300mm	110µm	10.8kg
2931-D9000A	9000mm	0-100mm	35µm	10.7kg
2931-D9000B	9000mm	0-200mm	70µm	11.1kg
2931-D9000C	9000mm	0-300mm	120µm	11.5kg

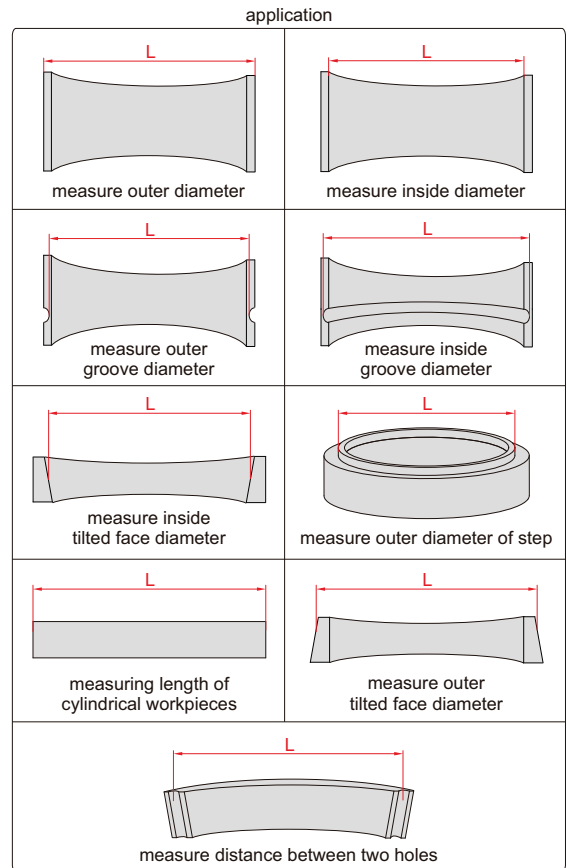



INTERNAL AND EXTERNAL DIAMETER COMPARISON INSTRUMENT

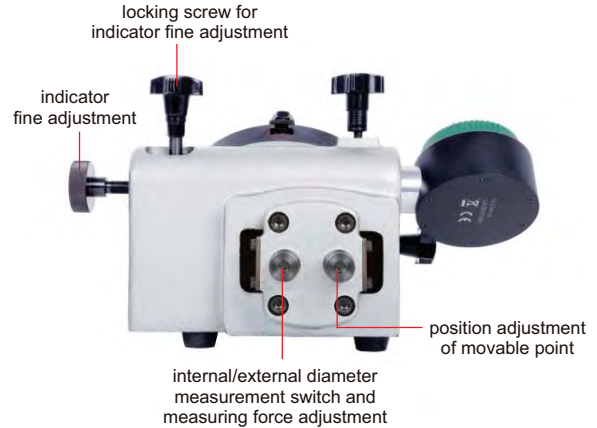

- Measure internal/external diameter, variation and taper
- Total range of movable point: 2mm, effective range of movable point: ±0.1mm
- Groove probes and disc probes are included
- Optional accessory: Ø28mm/Ø8mm bush (code 6843-B8), cross table, 0.001mm digital/dial indicators, high precision digital indicators (code 2140-6, 2140-6WL)

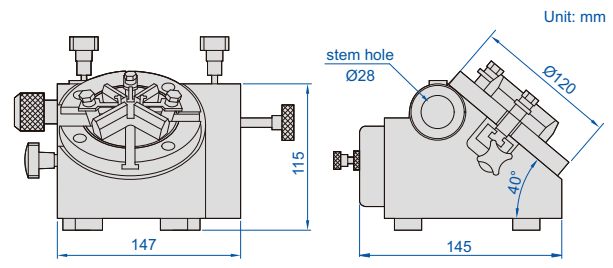

Code	Applicable holding stem	Range of internal diameter	Range of external diameter	Accuracy	Repeatability
6844-100	Ø28mm	20-100mm/0.8-3.9"	15-80mm/0.6-3.1"	±0.001mm	0.001mm

cross table (working with groove probes)

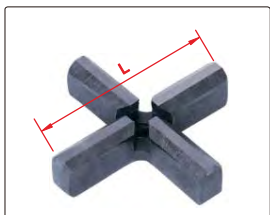

disc probes (included)



groove probes to measure small internal diameter and internal groove diameter

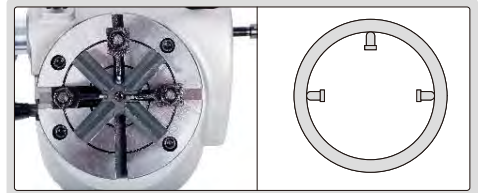

Cross table

Code	L	Remark
6844-T40	40mm	included
6844-T80	80mm	optional
6844-T100	100mm	optional

groove probe (included)



disc probes to measure large internal diameter

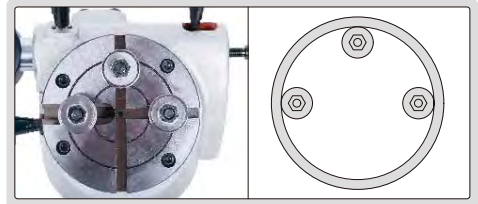

Ø28mm/Ø8mm bush (optional)



Code
6843-B8

application



disc probes to measure external diameter

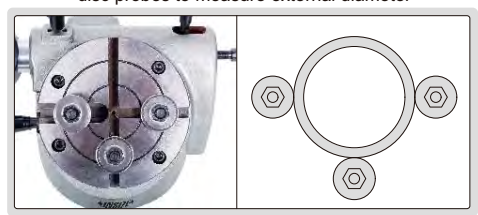

INTERNAL AND EXTERNAL DIAMETER COMPARISON INSTRUMENT



5

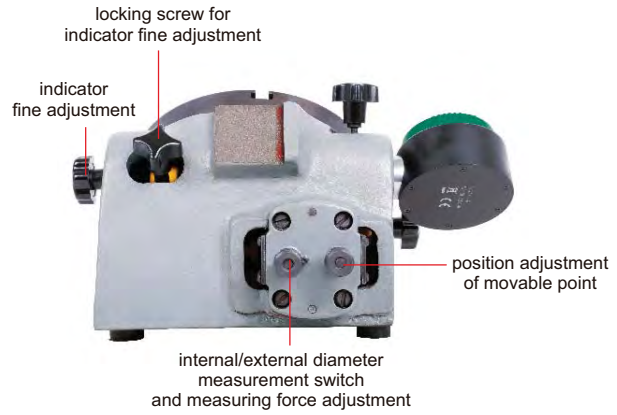
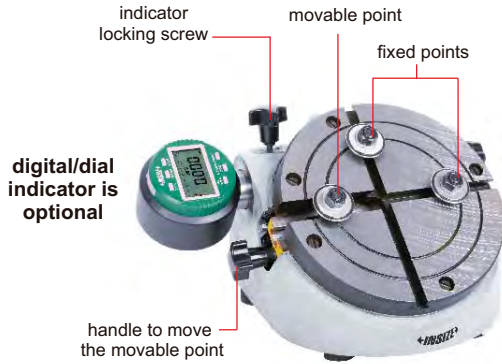

- Measure internal/external diameter, variation and taper
- Total range of movable point: 2mm, effective range of movable point: ± 0.1 mm
- Optional accessory: $\varnothing 28$ mm/ $\varnothing 8$ mm bush (code **6843-B8**), 0.001mm digital/dial indicators, high precision digital indicators (code **2140-6**, **2140-6WL**)

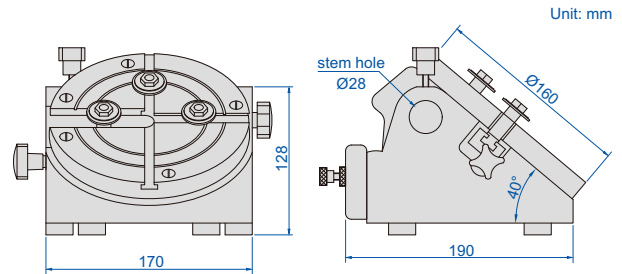

internal diameter measurement

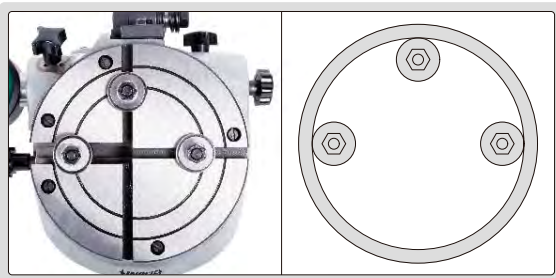

external diameter measurement

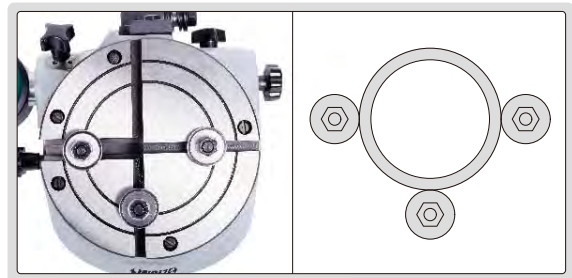

Code	Applicable holding stem	Range of internal diameter	Range of external diameter	Accuracy	Repeatability
6843-140	$\varnothing 28$ mm	50-140mm/2-5.5"	30-120mm/1.2-4.7"	± 0.001 mm	0.001mm

$\varnothing 28$ mm/ $\varnothing 8$ mm bush (optional)



Code
6843-B8

application





OUTSIDE DIAMETER MEASURING STAND

5



6847-50

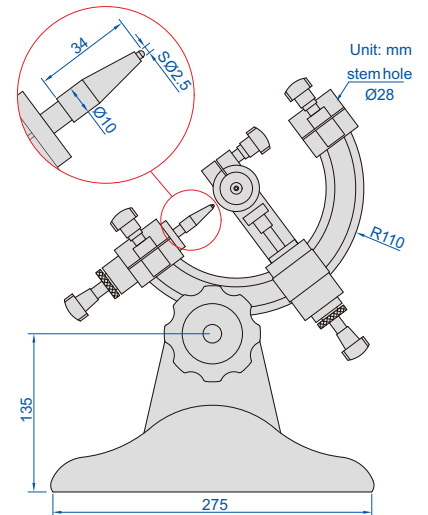

- To measure diameter and roundness of cylinders and steel balls
- Supplied with measuring base (code 6847-A100)
- Optional accessory: Ø28mm/Ø8mm bush (code 6843-B8), 0.001mm digital/dial indicators, high precision digital indicators (code 2140-6, 2140-6WL), gage blocks (4101 series, for zero setting of cylinders), custom plug gages (for zero setting of cylinders), ceramic standard balls (4190 series, for zero setting of steel balls)

Measuring base

Code	Diameter	Remark
6847-A10	10mm	optional
6847-A20	20mm	optional
6847-A30	30mm	optional
6847-A40	40mm	optional
6847-A50	50mm	optional
6847-A60	60mm	optional
6847-A70	70mm	optional
6847-A75	75mm	optional
6847-A80	80mm	optional
6847-A90	90mm	optional
6847-A100	100mm	included

Code	Range of outside diameter	Accuracy	Repeatability
6847-50	1.5-50mm/0.06-2"	±0.001mm	0.0005mm

Ø28mm/Ø8mm bush (optional)



Code
6843-B8

application





Digital Micrometers/Snap Gages
Page 96-98



Digital Micrometers
Page 99-106



Outside Micrometers
Page 107-110



Large Outside Micrometers
Page 110-113



Limit Micrometers
Page 113



Indicating Micrometers
Page 114



Micrometers With Dial Indicator
Page 114-116



Groove Micrometers
Page 117



3-wires
Page 117-118



Screw Thread Micrometers
Page 118-121



Gear Tooth Micrometers
Page 122-124



Point Micrometers
Page 125-126



Gear Root Diameter Micrometers
Page 127



Blade Micrometers
Page 128-130



Crimp Height Micrometers
Page 131



Spline Micrometers
Page 131-133



Tube Micrometers
Page 134-136



Disk Brake Micrometers
Page 137



Sheet Metal Micrometers
Page 137-138



Interchangeable Anvil Micrometers
Page 138-139



Large Anvil Micrometers
Page 139



V-anvil Micrometers
Page 140



Universal Micrometers
Page 141

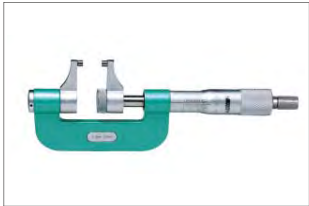

Caliper Type Micrometers
Page 142



Jaw Type Micrometers
Page 143

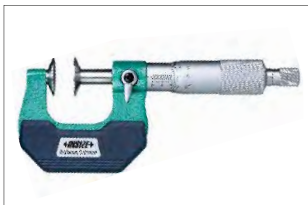

Disk Micrometers
Page 144-146



Sheet Metal Micrometers
Page 147



Micrometers For Hot Plate
Page 147



Hub Micrometers
Page 147



Wire Micrometers
Page 148



Can Seam Micrometers
Page 148



Optical Parallels
Page 148



Micrometer Measuring
Force Detectors
Page 149



Micrometer Inspection
Gage Block Sets
Page 149



Micrometer Stands
Page 149-150



Micrometer Setting
Standards
Page 151



Micrometer Lapping
Machines
Page 152-153



Micrometer Heads
Page 153-156

DIGITAL MICROMETERS/SNAP GAGES

ONE TURN OF SLEEVE MAKES 10MM SPINDLE FEED, PRESS THE FORK, THE SPINDLE RETRACTS 3MM

MEASUREMENT ACCURACY IS NOT AFFECTED BY THE USE OF SLEEVE

IP65 WATERPROOF

DATA OUTPUT

ABSOLUTE ENCODER, THE ORIGINAL DATA REMAINS AFTER POWER OFF

ATTENTION: RECHARGEABLE BATTERY, FOR 24 HOURS CONTINUOUS WORKING

NON-ROTATING SPINDLE



6



3358-25

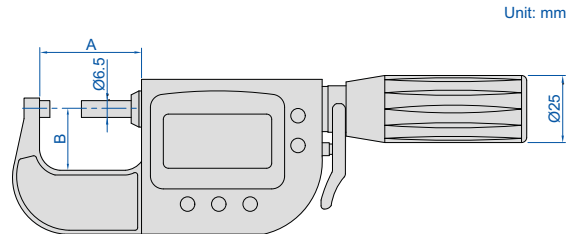

Unit: mm

- Absolute encoder, the original data remains after power off
- Resolution: 0.001mm/0.0005"
- One turn of sleeve makes 10mm spindle feed
- Measurement accuracy is not affected by the use of sleeve
- Press the fork, the spindle retracts 3mm
- Carbide spindle and anvil
- Measuring force 5-10N
- Button function: data output, tolerance, data preset, data hold, measuring direction change, max./min./TIR, power off time, on/off, zero, mm/inch
- Supplied with gage blocks for zero setting (except 0-25mm/0-1")
- Power: rechargeable battery, for 24 hours continuous working

alarm when over tolerance

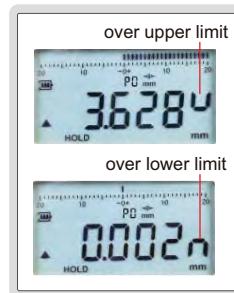

wireless receiver 2134-R1, 2134-R2 (optional)



With data interface

Optional accessory:

wireless transmitter, code 7315-3350 page 6

data output cable (keyboard format), code 7302-3350 page 13

Code	Range	Accuracy	Repeatability	Measuring faces		A	B
				flatness	parallelism		
3358-25 *	0-25mm/0-1"	2µm	1µm	0.5µm	1.2µm	38mm	24mm
3358-50 *	25-50mm/1-2"	2µm	1µm	0.5µm	1.2µm	64mm	32.5mm

Built-in wireless

Optional accessory:

wireless receiver (keyboard format, connect up to 15 digital indicators), code 2134-R1

wireless receiver (serial port format, connect up to 15 digital indicators), code 2134-R2

Code	Range	Accuracy	Repeatability	Measuring faces		A	B
				flatness	parallelism		
3358-25WL *	0-25mm/0-1"	2µm	1µm	0.5µm	1.2µm	38mm	24mm
3358-50WL *	25-50mm/1-2"	2µm	1µm	0.5µm	1.2µm	64mm	32.5mm

*Supplied with manufacturer inspection certificate



HIGH PRECISION DIGITAL MICROMETERS/SNAP GAGES (ADVANCED TYPE)

ONE TURN OF SLEEVE MAKES 5MM SPINDLE FEED, PRESS THE FORK, THE SPINDLE RETRACTS 3MM

MEASUREMENT ACCURACY IS NOT AFFECTED BY THE USE OF SLEEVE

IP65
WATERPROOF

DATA
OUTPUT

ATTENTION: RECHARGEABLE BATTERY, FOR 24 HOURS CONTINUOUS WORKING

NON-ROTATING
SPINDLE

ABSOLUTE ENCODER, THE ORIGINAL
DATA REMAINS AFTER POWER OFF



- Absolute encoder, the original data remains after power off
- Adjustable resolution: 0.0002mm/0.00001"
0.001mm/0.00005"
0.01mm/0.0005"
- One turn of sleeve makes 5mm spindle feed
- Measurement accuracy is not affected by the use of sleeve
- Press the fork, the spindle retracts 3mm
- Linear ball bearings for ten million times use
- Carbide spindle and anvil
- Measuring force 7-10N
Customizable measuring force range 2-12N
Attention: small measuring force will reduce the dustproof and waterproof level
- Button function: data output, tolerance, data preset, data hold, measuring direction change, max./min./TIR, power off time, on/off, zero, mm/inch, adjust resolution
- Supplied with gage blocks for zero setting (except 0-25mm/0-1")
- Power: rechargeable battery, for 24 hours continuous working



3350-25

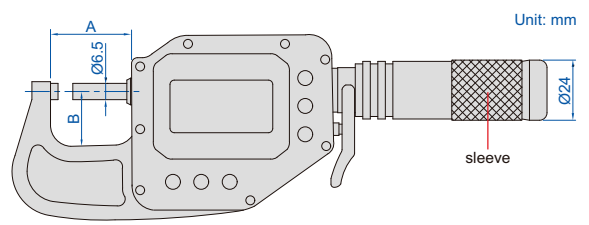

With data interface

Optional accessory:
wireless transmitter, code **7315-3350** page 6
data output cable (keyboard format), code **7302-3350** page 13

Code	Range	Accuracy	Repeatability	Measuring faces		A	B
				flatness	parallelism		
3350-25 *	0-25mm/0-1"	1.4µm	0.6µm	0.5µm	1µm	38mm	24mm
3350-50 *	25-50mm/1-2"	1.6µm	1µm	0.5µm	1µm	63mm	28mm
3350-75 *	50-75mm/2-3"	1.8µm	1µm	0.5µm	1µm	88mm	45mm
3350-100 *	75-100mm/3-3.95"	2µm	1µm	0.5µm	1µm	113mm	57mm

Built-in wireless

Optional accessory:
wireless receiver (keyboard format, connect up to 15 digital indicators), code **2134-R1**
wireless receiver (serial port format, connect up to 15 digital indicators), code **2134-R2**

Code	Range	Accuracy	Repeatability	Measuring faces		A	B
				flatness	parallelism		
3350-25WL *	0-25mm/0-1"	1.4µm	0.6µm	0.5µm	1µm	38mm	24mm
3350-50WL *	25-50mm/1-2"	1.6µm	1µm	0.5µm	1µm	63mm	28mm
3350-75WL *	50-75mm/2-3"	1.8µm	1µm	0.5µm	1µm	88mm	45mm
3350-100WL *	75-100mm/3-3.95"	2µm	1µm	0.5µm	1µm	113mm	57mm

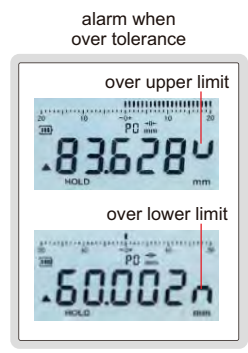

* Supplied with manufacturer inspection certificate

HIGH PRECISION DIGITAL MICROMETERS/SNAP GAGES

NON-ROTATING SPINDLE

ABSOLUTE ENCODER, THE ORIGINAL DATA REMAINS AFTER POWER OFF

IP65 WATERPROOF

DATA OUTPUT



ATTENTION: RECHARGEABLE BATTERY, FOR 24 HOURS CONTINUOUS WORKING

ONE TURN OF SLEEVE MAKES 5MM SPINDLE FEED, PRESS THE FORK, THE SPINDLE RETRACTS 3MM

MEASUREMENT ACCURACY IS NOT AFFECTED BY THE USE OF SLEEVE

gauge blocks for zero setting (included)



6

- Absolute encoder, the original data remains after power off
- Adjustable resolution: 0.0002mm/0.00001" (when the reading exceeds 100mm, the resolution is automatically switched to 0.001mm) 0.001mm/0.00005" 0.01mm/0.0005"
- One turn of sleeve makes 5mm spindle feed
- Measurement accuracy is not affected by the use of sleeve
- Press the fork, the spindle retracts 3mm
- Linear ball bearings for ten million times use
- Carbide spindle and anvil
- Measuring force 5-8N
Customizable measuring force range 2-12N
Attention: small measuring force will reduce the dustproof and waterproof level
- Button function: data output, tolerance, data preset, data hold, measuring direction change, max./min./TIR, power off time, on/off, zero, mm/inch, adjust resolution
- Supplied with gauge blocks for zero setting
- Power: rechargeable battery, for 24 hours continuous working



3351-275

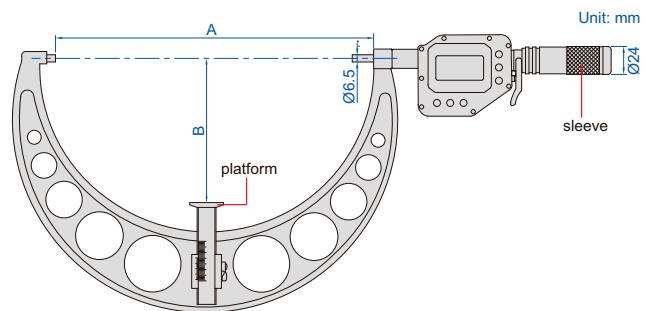

With data interface

Optional accessory:

wireless transmitter, code **7315-3350** page 6

data output cable (keyboard format), code **7302-3350** page 13

Code	Range	Accuracy	Repeatability	Measuring faces		A	B
				flatness	parallelism		
3351-125*	100-125mm/4-5"	3µm	1µm	0.5µm	2µm	128mm	62.5mm
3351-150*	125-150mm/5-6"	3µm	1µm	0.5µm	2µm	153mm	75mm
3351-175*	150-175mm/6-7"	4µm	1µm	0.5µm	2.5µm	178mm	87.5mm
3351-200*	175-200mm/7-8"	4µm	1µm	0.5µm	2.5µm	203mm	100mm
3351-225*	200-225mm/8-9"	5µm	1µm	0.5µm	3µm	228mm	112.5mm
3351-250*	225-250mm/9-10"	5µm	1µm	0.5µm	3µm	253mm	125mm
3351-275*	250-275mm/10-11"	6µm	1µm	0.5µm	3.5µm	278mm	137.5mm
3351-300*	275-300mm/11-12"	6µm	1µm	0.5µm	3.5µm	303mm	150mm

alarm when over tolerance

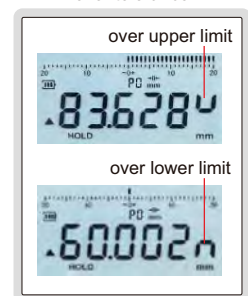

Built-in wireless

Optional accessory:

wireless receiver (keyboard format, connect up to 15 digital indicators), code **2134-R1**

wireless receiver (serial port format, connect up to 15 digital indicators), code **2134-R2**

Code	Range	Accuracy	Repeatability	Measuring faces		A	B
				flatness	parallelism		
3351-125WL*	100-125mm/4-5"	3µm	1µm	0.5µm	2µm	128mm	62.5mm
3351-150WL*	125-150mm/5-6"	3µm	1µm	0.5µm	2µm	153mm	75mm
3351-175WL*	150-175mm/6-7"	4µm	1µm	0.5µm	2.5µm	178mm	87.5mm
3351-200WL*	175-200mm/7-8"	4µm	1µm	0.5µm	2.5µm	203mm	100mm
3351-225WL*	200-225mm/8-9"	5µm	1µm	0.5µm	3µm	228mm	112.5mm
3351-250WL*	225-250mm/9-10"	5µm	1µm	0.5µm	3µm	253mm	125mm
3351-275WL*	250-275mm/10-11"	6µm	1µm	0.5µm	3.5µm	278mm	137.5mm
3351-300WL*	275-300mm/11-12"	6µm	1µm	0.5µm	3.5µm	303mm	150mm

wireless receiver 2134-R1, 2134-R2 (optional)



*Supplied with manufacturer inspection certificate

QUICK MEASUREMENT
ONE TURN OF SLEEVE OR RATCHET
STOP MAKES 2mm SPINDLE FEED

**INSPECTION
CERTIFICATE**

NON-ROTATING SPINDLE DIGITAL MICROMETERS

INSIZE PLUS
MADE IN EUROPE

LEVER FORCE MEASURING DEVICE
SUITABLE FOR MASS MEASUREMENT

IP65
WATERPROOF

**NON-ROTATING
SPINDLE**

**DATA
OUTPUT**



3632-80A

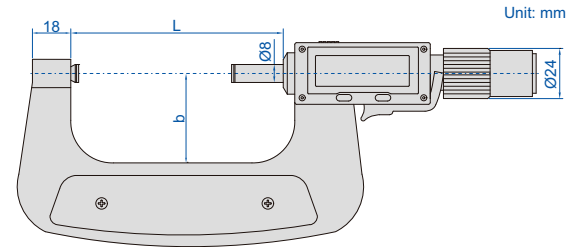

Unit: mm

- Adjustable resolution: 0.01mm/0.0005", 0.001mm/0.00005", 0.0005mm/0.00002"
- Repeatability: 1µm
- Measuring force: 5-10N
- Lever force measuring device, suitable for mass measurement
- No-rotating spindle, suitable for measuring cylindrical workpiece
- Quick measurement: one turn of sleeve or ratchet stop makes 2mm spindle feed
- Carbide measuring faces
- Data output
- Button function: mm/inch, max./min. value tracking, preset value, hold, on/off, zero
- Ratchet sets force measurement
- CR2032 battery, automatic power off
- Supplied with setting standards (except 0-30mm/ 0-1.18")
- Optional accessory: data output cable (code 7315-80, 7302-80)

lever force measuring device

press the lever force measuring device, the spindle retracted 1.5mm (MAX). release the force measuring device, the spindle extends, contacts the measured workpiece, and the measured force is constant

(mm)

Code	Range	Accuracy		L	b
		stroke≤25mm	stroke>25mm		
3632-30A *	0-30mm/0-1.18"	±2µm	±3µm	38	24
3632-55A *	25-55mm/0.98-2.17"	±2µm	±3µm	63	30.5
3632-80A *	50-80mm/1.97-3.15"	±3µm	±4µm	88	44
3632-105A *	75-105mm/2.95-4.13"	±3µm	±4µm	113	57
3632-130A *	100-130mm/3.94-5.12"	±3µm	±5µm	138	70
3632-155A *	125-155mm/4.92-6.1"	±3µm	±5µm	163	83
3632-180A *	150-180mm/5.91-7.09"	±4µm	±6µm	188	96
3632-205A *	175-205mm/6.89-8.07"	±4µm	±6µm	213	109
3632-230A *	200-230mm/7.87-9.06"	±4µm	±6µm	238	122
3632-255A *	225-255mm/8.86-10.04"	±4µm	±6µm	268	135
3632-280A *	250-280mm/9.84-11.02"	±5µm	±7µm	293	147.5
3632-305A *	275-305mm/10.83-12.01"	±5µm	±7µm	318	160

* Supplied with manufacturer inspection certificate

HIGH PRECISION NON-ROTATING SPINDLE DIGITAL MICROMETERS

INSIZE PLUS
MADE IN EUROPE

ATTENTION: SETTING
STANDARDS ARE NOT INCLUDED

QUICK MEASUREMENT
ONE TURN OF SLEEVE OR RATCHET
STOP MAKES 2MM SPINDLE FEED

IP65
WATERPROOF

NON-ROTATING
SPINDLE

DATA
OUTPUT

STROKE
30mm

6



3661-30

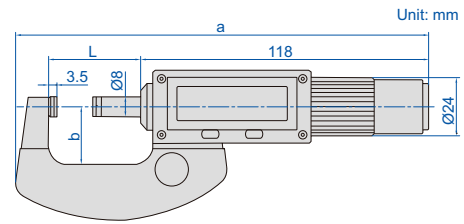

- Adjustable resolution: 0.01mm/0.0005", 0.001mm/0.00005", 0.0005mm/0.00002"
- Repeatability: 0.5µm
- Measuring force: 5-10N
- Flatness of measuring faces: 0.3µm
- Parallelism of measuring faces: 0.5µm
- Ratchet stop
- Non-rotating spindle, suitable for cylinders
- Quick measurement: one turn of sleeve or ratchet stop makes 2mm spindle feed
- Carbide measuring faces
- Data output
- Button function: mm/inch, max./min. value tracking, preset value, hold, on/off, zero
- CR2032 battery
- Automatic power off, turn the sleeve to turn on
- Optional accessory: setting standards (code **7386**), data output cable (code **7315-80**, **7302-80**)

(mm)

Code	Range	Accuracy		L	a	b
		stroke ≤25mm	stroke >25mm			
3661-30	0-30mm/0-1.18"	±2µm	±3µm	38	169	24
3661-55	25-55mm/0.98-2.17"	±2µm	±3µm	63	195	30.5
3661-80	50-80mm/1.97-3.15"	±3µm	±4µm	88	228	44
3661-105	75-105mm/2.95-4.13"	±3µm	±4µm	113	257	57
3661-130	100-130mm/3.94-5.12"	±3µm	±5µm	138	289	70
3661-155	125-155mm/4.92-6.1"	±3µm	±5µm	163	315	83
3661-180	150-180mm/5.91-7.09"	±4µm	±6µm	188	340	96
3661-205	175-205mm/6.89-8.07"	±4µm	±6µm	213	363	109
3661-230	200-230mm/7.87-9.06"	±4µm	±6µm	238	388	122
3661-255	225-255mm/8.86-10.04"	±4µm	±6µm	268	429	135
3661-280	250-280mm/9.84-11.02"	±5µm	±7µm	293	454	147.5
3661-305	275-305mm/10.83-12.01"	±5µm	±7µm	318	479	160

WATERPROOF DIGITAL OUTSIDE MICROMETERS (WITH DATA OUTPUT INTERFACE)

DATA
OUTPUT

IP65
WATERPROOF

INSPECTION
CERTIFICATE

POPULAR
MODEL

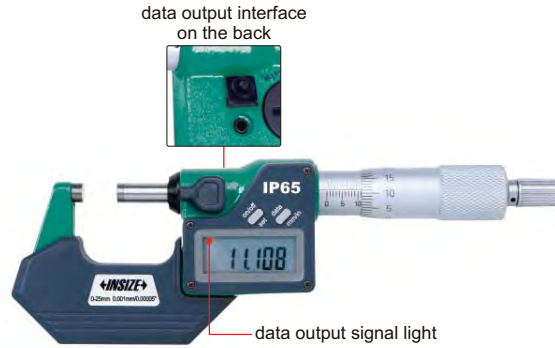

3101-25A

- IP65 dust/waterproof
- Button function: on/off, set, mm/inch, data transmit
- Automatic power off
- Carbide measuring faces
- Supplied with spherical anvil
- Setting standards are included (except 0-25mm/0-1")
- Optional accessory: data output cable (code 7315-31 page 4, 7302-31 page 12)

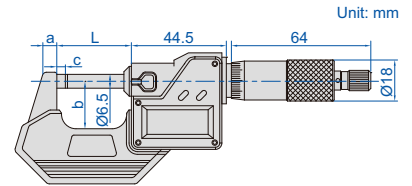

Metric/Inch type (ratchet stop)

(mm)

Code	Range	Resolution	Accuracy	L	a	b	c
3101-25A*	0-25mm/0-1"	0.001mm/0.00005"	±2µm	34.5	6	25	3
3101-50A*	25-50mm/1-2"	0.001mm/0.00005"	±2µm	59.5	8	32	3
3101-75A*	50-75mm/2-3"	0.001mm/0.00005"	±3µm	84.5	8	44.5	3
3101-100A*	75-100mm/3-4"	0.001mm/0.00005"	±3µm	109.5	8	57	3
3101-125A	100-125mm/4-5"	0.001mm/0.00005"	±3µm	135	10	70	3
3101-150A	125-150mm/5-6"	0.001mm/0.00005"	±3µm	160.5	10	82	3
3101-175A	150-175mm/6-7"	0.001mm/0.00005"	±4µm	186	12	94.5	5.5
3101-200A	175-200mm/7-8"	0.001mm/0.00005"	±4µm	211.5	12	107	5.5
3101-225A	200-225mm/8-9"	0.001mm/0.00005"	±4µm	236	23	129.5	5.5
3101-250A	225-250mm/9-10"	0.001mm/0.00005"	±4µm	261.5	23	142.5	5.5
3101-275A	250-275mm/10-11"	0.001mm/0.0001"	±5µm	287	23	155	5.5
3101-300A	275-300mm/11-12"	0.001mm/0.0001"	±5µm	312.5	23	167.5	5.5



Metric/Inch type (friction thimble)

(mm)

Code	Range	Resolution	Accuracy	L	a	b	c
3101-25FA*	0-25mm/0-1"	0.001mm/0.00005"	±2µm	34.5	6	25	3

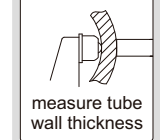

Metric type (ratchet stop)

(mm)

Code	Range	Resolution	Accuracy	L	a	b	c
3101-25AJ*	0-25mm	0.001mm	±2µm	34.5	6	25	3
3101-50AJ*	25-50mm	0.001mm	±2µm	59.5	8	32	3
3101-75AJ*	50-75mm	0.001mm	±3µm	84.5	8	44.5	3
3101-100AJ*	75-100mm	0.001mm	±3µm	109.5	8	57	3

Set (ratchet stop type)

Code	Range	Micrometers included	Packaging
3101-753A*	0-75mm/0-3"	3101-25A, 3101-50A, 3101-75A	blow mould case
3101-1004A*	0-100mm/0-4"	3101-25A, 3101-50A, 3101-75A, 3101-100A	blow mould case
3101-1506A	0-150mm/0-6"	3101-25A, 3101-50A, 3101-75A, 3101-100A, 3101-125A, 3101-150A	aluminum box



3101-753A

3101-1506A

*Supplied with manufacturer inspection certificate

WATERPROOF DIGITAL OUTSIDE MICROMETERS (WITHOUT DATA OUTPUT)

IP65
WATERPROOF

ATTENTION: NO DATA OUTPUT

INSPECTION CERTIFICATE

6



3108-25A

- Resolution 0.001mm/0.00005"
- IP65 dust/waterproof
- Button function: on/off, set, mm/inch, ABS/INC
- No data output
- Automatic power off
- Carbide measuring faces
- Supplied with spherical anvil
- Setting standards are included (except 0-25mm/0-1")

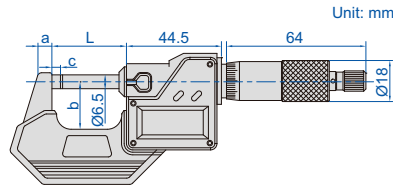

Ratchet stop type

Code	Range	Accuracy	L	a	b	c	(mm)
3108-25A*	0-25mm/0-1"	±2µm	34.5	6	25	3	
3108-50A*	25-50mm/1-2"	±2µm	59.5	8	32	3	
3108-75A*	50-75mm/2-3"	±3µm	84.5	8	44.5	3	
3108-100A*	75-100mm/3-4"	±3µm	109.5	8	57	3	
3108-125A	100-125mm/4-5"	±3µm	135	10	70	3	
3108-150A	125-150mm/5-6"	±3µm	160.5	10	82	3	
3108-175A	150-175mm/6-7"	±4µm	186	12	94.5	5.5	
3108-200A	175-200mm/7-8"	±4µm	211.5	12	107	5.5	



Friction thimble type

Code	Range	Accuracy	L	a	b	c	(mm)
3108-25FA*	0-25mm/0-1"	±2µm	34.5	6	25	3	



3108-753A



3108-1506A

Set

Code	Range	Micrometers included	Packaging
3108-753A*	0-75mm/0-3"	3108-25A, 3108-50A, 3108-75A	blow mould case
3108-1004A*	0-100mm/0-4"	3108-25A, 3108-50A, 3108-75A, 3108-100A	blow mould case
3108-1506A	0-150mm/0-6"	3108-25A, 3108-50A, 3108-75A, 3108-100A, 3108-125A, 3108-150A	aluminum box

*Supplied with manufacturer inspection certificate

DATA
OUTPUT

DIGITAL OUTSIDE MICROMETERS (BASIC TYPE, WITH DATA OUTPUT)

**INSPECTION
CERTIFICATE**



3102-25

- Resolution 0.001mm/0.00005"
- Button function: on/off, set, mm/inch, data transmit
- Automatic power off
- Carbide measuring faces
- Friction thimble
- Supplied with spherical anvil
- Setting standards are included (except 0-25mm/0-1")
- Optional accessory: data output cable (code 7315-30 page 4, 7302-30 page 12)

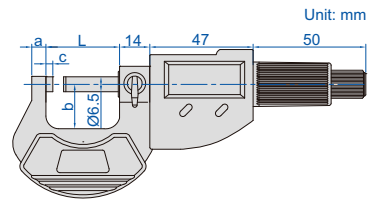

Individual		(mm)				
Code	Range	Accuracy	L	a	b	c
3102-25 *	0-25mm/0-1"	±2µm	32	6	24	3
3102-50 *	25-50mm/1-2"	±2µm	57	8	32	3
3102-75 *	50-75mm/2-3"	±3µm	82	8	45	3
3102-100 *	75-100mm/3-4"	±3µm	107	10	57	3
3102-125	100-125mm/4-5"	±3µm	133	10	70	3
3102-150	125-150mm/5-6"	±3µm	158	10	82	3
3102-175	150-175mm/6-7"	±4µm	183	12	95	5.5
3102-200	175-200mm/7-8"	±4µm	209	12	107	5.5



3102-753A



3102-1506A

Set

Code	Range	Micrometers included	Packaging
3102-753A *	0-75mm/0-3"	3102-25, 3102-50, 3102-75	blow mould case
3102-1004A *	0-100mm/0-4"	3102-25, 3102-50, 3102-75, 3102-100	blow mould case
3102-1506A	0-150mm/0-6"	3102-25, 3102-50, 3102-75, 3102-100, 3102-125, 3102-150	aluminum box

* Supplied with manufacturer inspection certificate

DIGITAL OUTSIDE MICROMETERS (BASIC TYPE, WITHOUT DATA OUTPUT)

ATTENTION: NO DATA OUTPUT

POPULAR MODEL

INSPECTION CERTIFICATE

- Resolution 0.001mm/0.00005"
- Button function: on/off, set, mm/inch, ABS/INC
- No data output
- Automatic power off
- Carbide measuring faces
- Friction thimble
- Supplied with spherical anvil
- Setting standards are included (except 0-25mm/0-1")



3109-25A

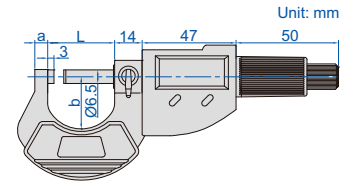

6

Individual

Code	Range	Accuracy	L	a	b
3109-25A*	0-25mm/0-1"	±2µm	32mm	6mm	27.5mm
3109-50A*	25-50mm/1-2"	±2µm	57mm	8mm	37mm
3109-75A*	50-75mm/2-3"	±3µm	82mm	8mm	50mm
3109-100A*	75-100mm/3-4"	±3µm	107mm	10mm	61mm
3109-125A	100-125mm/4-5"	±3µm	132mm	10mm	73mm
3109-150A	125-150mm/5-6"	±3µm	157mm	10mm	85mm
3109-175A	150-175mm/6-7"	±4µm	182mm	21mm	104mm
3109-200A	175-200mm/7-8"	±4µm	207mm	21mm	117mm

Set

Code	Range	Micrometers included	Packaging
3109-753A*	0-75mm/0-3"	3109-25A, 3109-50A, 3109-75A	blow mould case
3109-1004A*	0-100mm/0-4"	3109-25A, 3109-50A, 3109-75A, 3109-100A	blow mould case
3109-1506A	0-150mm/0-6"	3109-25A, 3109-50A, 3109-75A, 3109-100A, 3109-125A, 3109-150A	aluminum box

*Supplied with manufacturer inspection certificate



spherical anvil (included)

measure tube wall thickness



friction thimble for one hand operation



3109-753A



3109-1506A

DIGITAL VERTICAL MICROMETERS

DATA OUTPUT

IP65 WATERPROOF

INSPECTION CERTIFICATE

- Measure the thickness of plates for easy reading
- Resolution 0.001mm/0.00005"
- IP65 dust/waterproof
- Button function: on/off, set, mm/inch, ABS/INC
- Data output
- Automatic power off
- Carbide spindle tip
- Ratchet stop
- Supplied with setting standards (except 0-25mm/0-1")
- Optional accessory: data output cable (code 7315-30 page 4, 7302-30 page 12)



3565-25A

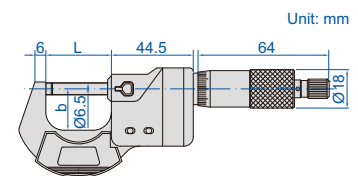

Code	Range	Type	Accuracy	L	b
3565-25A*	0-25mm/0-1"	A	±2µm	34.5mm	25mm
3565-50A*	25-50mm/1-2"	A	±2µm	59.5mm	32mm
3565-25BA*	0-25mm/0-1"	B	±2µm	34.5mm	25mm
3565-50BA*	25-50mm/1-2"	B	±2µm	59.5mm	32mm

*Supplied with manufacturer inspection certificate

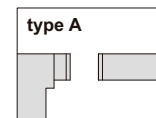

type A

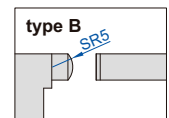

type B SR5

ATTENTION: SETTING STANDARDS ARE NOT INCLUDED



OUTSIDE MICROMETERS

INSIZE PLUS
MADE IN EUROPE

- Carbide measuring faces
- Graduation: 0.01mm
- Meet DIN863-1
- Friction thimble
- Optional accessory: setting standards (code 7386)

Code	Range	Accuracy	L	b
3701-25A *	0-25mm	4µm	37mm	24mm
3701-50A *	25-50mm	4µm	62mm	34mm
3701-75A *	50-75mm	5µm	87mm	46mm
3701-100A *	75-100mm	5µm	112mm	60mm
3701-125A *	100-125mm	6µm	139mm	72mm
3701-150A *	125-150mm	6µm	164mm	85mm
3701-175A *	150-175mm	7µm	190mm	97mm
3701-200A *	175-200mm	7µm	215mm	110mm
3701-225A *	200-225mm	8µm	240mm	122mm
3701-250A *	225-250mm	8µm	264mm	135mm
3701-275A *	250-275mm	9µm	290mm	148mm
3701-300A *	275-300mm	9µm	315mm	160mm

* Supplied with manufacturer inspection certificate



3701-25A

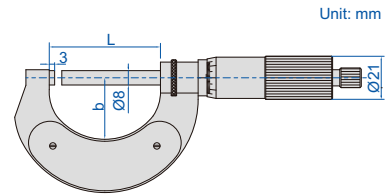

ATTENTION: SETTING STANDARDS ARE NOT INCLUDED

LIGHT WEIGHT

OUTSIDE MICROMETERS WITH 50mm RANGE

INSIZE PLUS
MADE IN EUROPE

- Graduation 0.01mm
- Ratchet stop
- One turn of sleeve makes 1mm spindle feed
- Carbide measuring faces
- Optional accessory: setting standards (code 7386)

Code	Range	Type	Accuracy	L	b	Weight
3682-50	0-50mm	A	4µm	62	34	0.46kg
3682-100	50-100mm	A	5µm	112	60	0.62kg
3682-150	100-150mm	A	6µm	164	85	0.78kg
3682-200	150-200mm	A	7µm	215	110	1.03kg
3682-250	200-250mm	A	8µm	264	135	1.25kg
3682-300	250-300mm	A	9µm	315	160	1.45kg
3682-350	300-350mm	B	10µm	370	190	1.50kg
3682-400	350-400mm	B	11µm	430	220	1.80kg
3682-450	400-450mm	B	12µm	475	250	2.15kg
3682-500	450-500mm	B	13µm	530	273	2.30kg
3682-550	500-550mm	B	14µm	570	291	2.40kg
3682-600	550-600mm	B	14µm	630	323	3.00kg
3682-650	600-650mm	B	16µm	675	351	3.30kg
3682-700	650-700mm	B	16µm	730	378	3.70kg
3682-750	700-750mm	B	18µm	785	401	3.90kg
3682-800	750-800mm	B	18µm	830	423	4.10kg
3682-850	800-850mm	B	20µm	885	440	4.30kg
3682-900	850-900mm	B	20µm	930	473	4.90kg
3682-950	900-950mm	B	22µm	980	503	5.80kg
3682-1000	950-1000mm	B	22µm	1030	520	6.10kg



3682-50

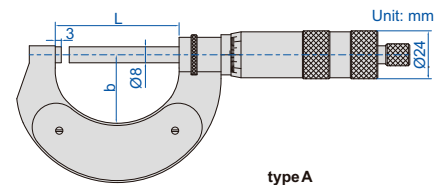

type A

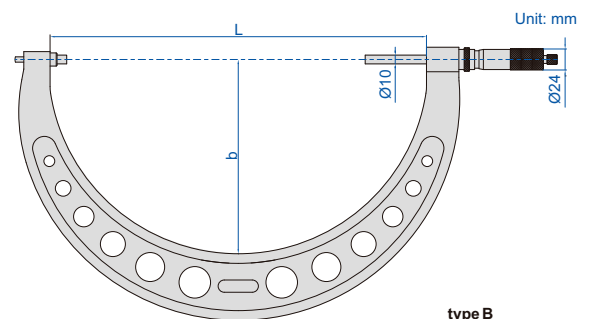

type B

OUTSIDE MICROMETERS (GRADUATION 0.005mm)

INSIZE PLUS
MADE IN EUROPE

ATTENTION: SETTING
STANDARDS ARE NOT INCLUDED

- Graduation 0.005mm
- Friction thimble
- One turn of sleeve makes 0.5mm spindle feed
- Carbide measuring faces
- Optional accessory: setting standards (code **7386**)

6



3681-25

(mm)				
Code	Range	Accuracy	L	b
3681-25	0-25mm	4µm	37	24
3681-50	25-50mm	4µm	62	34
3681-75	50-75mm	5µm	87	46
3681-100	75-100mm	5µm	112	60
3681-125	100-125mm	6µm	139	72
3681-150	125-150mm	6µm	164	85
3681-175	150-175mm	7µm	190	97
3681-200	175-200mm	7µm	215	110
3681-225	200-225mm	8µm	240	122
3681-250	225-250mm	8µm	264	135
3681-275	250-275mm	9µm	290	148
3681-300	275-300mm	9µm	315	160

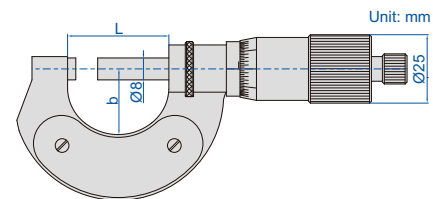

OUTSIDE MICROMETERS

INSPECTION
CERTIFICATE

- Graduation 0.01mm
- Carbide measuring faces
- Meet DIN863-1
- Supplied with setting standards (except 0-25mm)

Individual

Code	Range	Accuracy	L	a	b
3202-25A *	0-25mm	4µm	32mm	6mm	24mm
3202-50A *	25-50mm	4µm	57mm	8mm	32mm
3202-75A *	50-75mm	5µm	82mm	8mm	45mm
3202-100A *	75-100mm	5µm	107mm	8mm	57mm
3202-125A	100-125mm	6µm	133mm	8mm	70mm
3202-150A	125-150mm	6µm	125mm	8mm	82mm
3202-175A	150-175mm	7µm	183mm	8mm	95mm
3202-200A	175-200mm	7µm	209mm	8mm	107mm



3202-25A

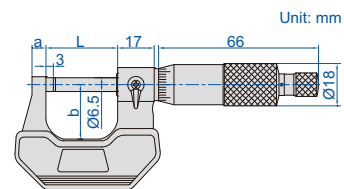

Set

Code	Range	Micrometers included
3202-753A *	0-75mm	3202-25A, 3202-50A, 3202-75A
3202-1004A *	0-100mm	3202-25A, 3202-50A, 3202-75A, 3202-100A
3202-1506A	0-150mm	3202-25A, 3202-50A, 3202-75A, 3202-100A, 3202-125A, 3202-150A

* Supplied with manufacturer inspection certificate

POPULAR MODEL

INSPECTION CERTIFICATE

OUTSIDE MICROMETERS



3203-25A



3203-50A



3203-1004A



3203-3006A

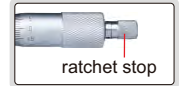

6

- Graduation: metric 0.01mm
inch 0.0001"
- Carbide measuring faces
- Meet DIN863-1
- Supplied with setting standards (except 0-25mm and 0-1")

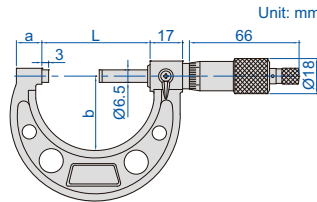

Metric (ratchet stop type)

Code	Range	Accuracy	L	a	b
3203-25A*	0-25mm	±2µm	32mm	9mm	28mm
3203-50A*	25-50mm	±2µm	57mm	14mm	38mm
3203-75A*	50-75mm	±2µm	82mm	15mm	49mm
3203-100A*	75-100mm	±3µm	107mm	15mm	60mm
3203-125A	100-125mm	±3µm	133mm	16.5mm	73mm
3203-150A	125-150mm	±3µm	158mm	16.5mm	85mm
3203-175A	150-175mm	±4µm	183mm	19.4mm	104mm
3203-200A	175-200mm	±4µm	209mm	19.4mm	117mm
3203-225A	200-225mm	±4µm	234mm	19.4mm	130mm
3203-250A	225-250mm	±5µm	260mm	19.4mm	142mm
3203-275A	250-275mm	±5µm	285mm	19.4mm	155mm
3203-300A	275-300mm	±5µm	310mm	19.4mm	168mm

Inch (ratchet stop type)

Code	Range	Accuracy	L	a	b
3203-1A*	0-1"	±0.0001"	1.260"	0.354"	1.102"
3203-2A*	1-2"	±0.0001"	2.244"	0.551"	1.496"
3203-3A*	2-3"	±0.0001"	3.228"	0.591"	1.929"
3203-4A*	3-4"	±0.00015"	4.213"	0.591"	2.362"
3203-5A*	4-5"	±0.00015"	5.236"	0.650"	2.874"
3203-6A*	5-6"	±0.00015"	6.220"	0.650"	3.346"
3203-7A	6-7"	±0.0002"	7.205"	0.764"	4.094"
3203-8A	7-8"	±0.0002"	8.228"	0.764"	4.606"
3203-9A	8-9"	±0.0002"	9.213"	0.764"	5.118"
3203-10A	9-10"	±0.00025"	10.236"	0.764"	5.591"
3203-11A	10-11"	±0.00025"	11.220"	0.764"	6.102"
3203-12A	11-12"	±0.00025"	12.205"	0.764"	6.614"

Metric micrometer set (ratchet stop type)

Code	Range	Micrometers included	Packaging
3203-753A*	0-75mm	3203-25A, 3203-50A, 3203-75A	blow mould case
3203-1004A*	0-100mm	3203-25A, 3203-50A, 3203-75A, 3203-100A	blow mould case
3203-1506A	0-150mm	3203-25A, 3203-50A, 3203-75A, 3203-100A, 3203-125A, 3203-150A	blow mould case
3203-3006A	150-300mm	3203-175A, 3203-200A, 3203-225A, 3203-250A, 3203-275A, 3203-300A	aluminum box
3203-3012A	0-300mm	3203-25A, 3203-50A, 3203-75A, 3203-100A, 3203-125A, 3203-150A, 3203-175A, 3203-200A, 3203-225A, 3203-250A, 3203-275A, 3203-300A	aluminum box

Inch micrometer set (ratchet stop type)

Code	Range	Micrometers included	Packaging
3203-33A*	0-3"	3203-1A, 3203-2A, 3203-3A	blow mould case
3203-44A*	0-4"	3203-1A, 3203-2A, 3203-3A, 3203-4A	blow mould case
3203-66A*	0-6"	3203-1A, 3203-2A, 3203-3A, 3203-4A, 3203-5A, 3203-6A	blow mould case
3203-126A	6-12"	3203-7A, 3203-8A, 3203-9A, 3203-10A, 3203-11A, 3203-12A	aluminum box
3203-1212A	0-12"	3203-1A, 3203-2A, 3203-3A, 3203-4A, 3203-5A, 3203-6A, 3203-7A, 3203-8A, 3203-9A, 3203-10A, 3203-11A, 3203-12A	aluminum box

Inch (friction thimble type)

Code	Range	Accuracy	L	a	b
3203-1FA*	0-1"	±0.0001"	1.260"	0.354"	1.102"
3203-2FA*	1-2"	±0.0001"	2.244"	0.551"	1.496"
3203-3FA*	2-3"	±0.0001"	2.244"	0.591"	1.929"

*Supplied with manufacturer inspection certificate

1µm GRADUATION OUTSIDE MICROMETERS



6

- Graduation 0.001mm
- Carbide measuring faces
- Meet DIN863-1
- Supplied with setting standards (except 0-25mm)



3210-25A

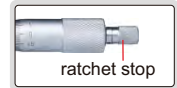

Ratchet stop type (mm)

Code	Range	Accuracy	L	a	b
3210-25A *	0-25mm	4µm	32	9	28
3210-50A *	25-50mm	4µm	57	14	38
3210-75A *	50-75mm	5µm	82	15	49
3210-100A *	75-100mm	5µm	107	15	60
3210-125A	100-125mm	6µm	133	16.5	73
3210-150A	125-150mm	6µm	158	16.5	85
3210-175A	150-175mm	7µm	183	19.4	104
3210-200A	175-200mm	7µm	209	19.4	117

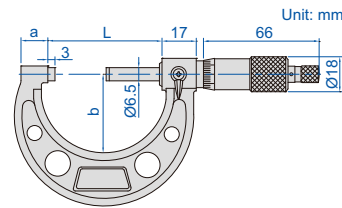

Friction thimble type (mm)

Code	Range	Accuracy	L	a	b
3210-25FA *	0-25mm	4µm	32	9	28
3210-50FA *	25-50mm	4µm	57	14	38

* Supplied with manufacturer inspection certificate

Micrometer set (ratchet stop type)

Code	Range	Micrometers included
3210-753A *	0-75mm	3210-25A, 3210-50A, 3210-75A
3210-1004A *	0-100mm	3210-25A, 3210-50A, 3210-75A, 3210-100A
3210-1506A	0-150mm	3210-25A, 3210-50A, 3210-75A, 3210-100A, 3210-125A, 3210-150A

OUTSIDE MICROMETERS WITH COUNTER



- Counter resolution: 0.01mm
- Thimble graduation: 0.01mm
- Carbide measuring faces
- Meet DIN863-1
- Ratchet stop
- Supplied with setting standards (except 0-25mm)



3400-25

Code	Range	Accuracy	L	a	b
3400-25 *	0-25mm	4µm	32mm	6mm	26mm
3400-50 *	25-50mm	4µm	57mm	8mm	32mm
3400-75 *	50-75mm	5µm	82mm	8mm	44.5mm
3400-100 *	75-100mm	5µm	107mm	8mm	57mm
3400-125 *	100-125mm	6µm	132.4mm	17mm	71.8mm
3400-150 *	125-150mm	6µm	157.8mm	17mm	84mm
3400-175 *	150-175mm	7µm	185mm	20mm	98.5mm
3400-200 *	175-200mm	7µm	210.4mm	20mm	111mm
3400-225 *	200-225mm	8µm	236mm	20mm	124mm
3400-250 *	225-250mm	8µm	261mm	20mm	136.5mm
3400-275 *	250-275mm	9µm	287mm	20mm	149mm
3400-300 *	275-300mm	9µm	312mm	20mm	162mm

* Supplied with manufacturer inspection certificate

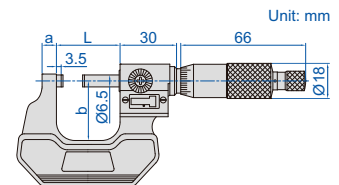

QUICK FEEDING OUTSIDE MICROMETERS

- Graduation 0.01mm
- 1mm feeding of each turn
- Friction thimble
- Carbide measuring faces
- Meet DIN863-1
- Supplied with setting standards (except 0-25mm)



3208-25B

Code	Range	Accuracy	L	a	b
3208-25B	0-25mm	4μm	32mm	6mm	24mm
3208-50B	25-50mm	4μm	57mm	8mm	32mm
3208-75B	50-75mm	5μm	82mm	8mm	45mm
3208-100B	75-100mm	5μm	107mm	8mm	57mm
3208-125B	100-125mm	6μm	133mm	8mm	70mm
3208-150B	125-150mm	6μm	158mm	8mm	82mm
3208-175B	150-175mm	7μm	183mm	8mm	95mm
3208-200B	175-200mm	7μm	209mm	8mm	107mm

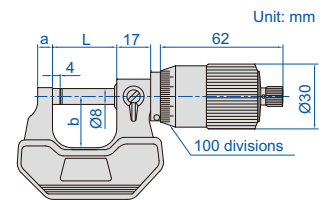

LONG SPINDLE OUTSIDE MICROMETERS

- Graduation 0.01mm
- Carbide measuring faces
- Meet DIN863-1
- Ratchet stop
- Supplied with setting standards (except 0-25mm)



3209-25

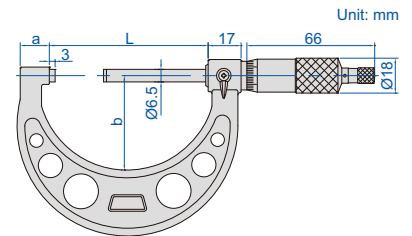

Code	Range	Accuracy	L	a	b
3209-25	0-25mm	4μm	57mm	14mm	38mm
3209-50	25-50mm	4μm	82mm	15mm	49mm
3209-75	50-75mm	5μm	107mm	15mm	60mm
3209-100	75-100mm	5μm	133mm	16.5mm	73mm

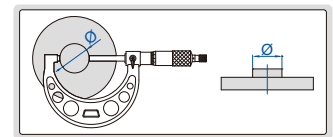
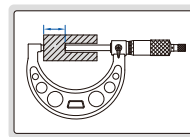

NON MAGNETIC MICROMETERS

- Suitable for magnetic materials
- Graduation: 0.01mm
- Non magnetic carbide measuring faces
- Ratchet stop



3231-25A

Code	Range	Accuracy	L	b
3231-25A	0-25mm	4μm	32mm	24mm
3231-50A	25-50mm	4μm	57mm	32mm
3231-75A	50-75mm	5μm	82mm	45mm
3231-100A	75-100mm	5μm	105mm	57mm

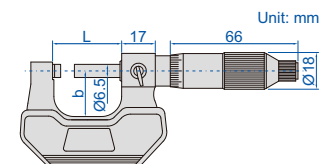

OUTSIDE MICROMETERS FOR LEFT OR RIGHT HANDERS

- Graduation 0.01mm
- Graduations on two sides
- Ratchet stop
- Carbide measuring faces
- Meet DIN863-1
- Supplied with setting standards (except 0-25mm)

6



3236-25B

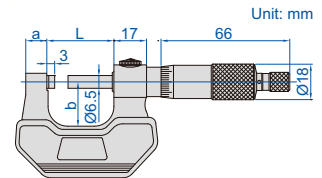

Code	Range	Accuracy	L	a	b
3236-25B	0-25mm	4µm	32	6	24
3236-50B	25-50mm	4µm	57	8	32
3236-75B	50-75mm	5µm	82	8	45
3236-100B	75-100mm	5µm	107	8	57
3236-125B	100-125mm	6µm	133	8	70
3236-150B	125-150mm	6µm	158	8	82
3236-175B	150-175mm	7µm	183	8	95
3236-200B	175-200mm	7µm	209	8	107

OUTSIDE MICROMETERS WITH INTERCHANGEABLE ANVILS

- Graduation 0.01mm
- Ratchet stop
- Meet DIN863-3
- Carbide measuring faces
- Supplied with setting standards

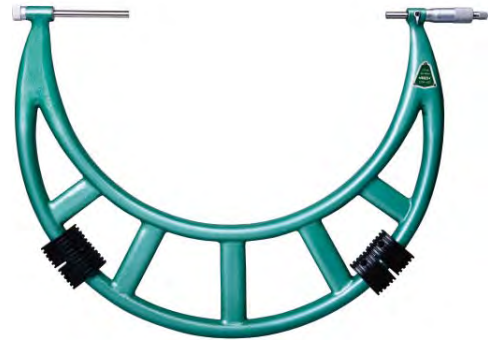

3206-400

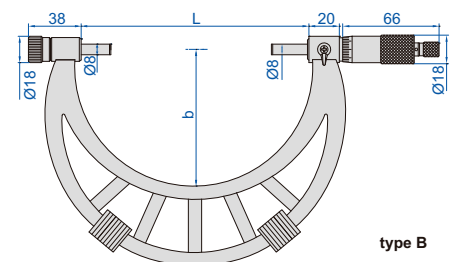
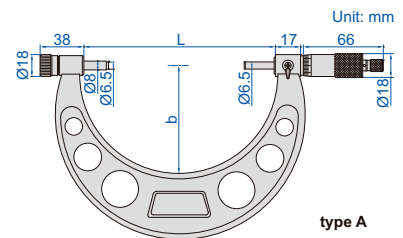
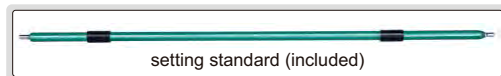
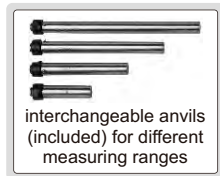

Code	Range	Type	Accuracy	L	b	Setting standard (included)
3206-50A	0-50mm	A	4µm	58	35	25
3206-100A	0-100mm	A	5µm	108	57	25, 50, 75
3206-150A	0-150mm	A	6µm	158	82	25, 50, 75, 100, 125
3206-151A	50-150mm	A	6µm	158	82	50, 75, 100, 125
3206-200A	100-200mm	A	7µm	208	114	100, 125, 150, 175
3206-300A	150-300mm	A	9µm	308	165	150, 175, 200, 225, 250, 275
3206-301A	200-300mm	A	9µm	308	165	200, 225, 250, 275
3206-400	300-400mm	B	11µm	409	224	325, 375
3206-500	400-500mm	B	13µm	509	275	425, 475
3206-600	500-600mm	B	14µm	609	321	525, 575
3206-700	600-700mm	B	16µm	709	371	625, 675
3206-800	700-800mm	B	18µm	809	426	725, 775
3206-900	800-900mm	B	20µm	909	476	825, 875
3206-1000	900-1000mm	B	22µm	1009	576	925, 975

IP65
WATERPROOF

DATA
OUTPUT

DIGITAL OUTSIDE MICROMETERS WITH INTERCHANGEABLE ANVILS



3506-100A



3506-400A

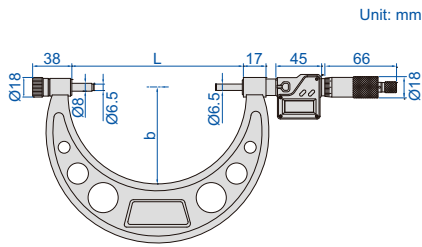

type A

Unit: mm

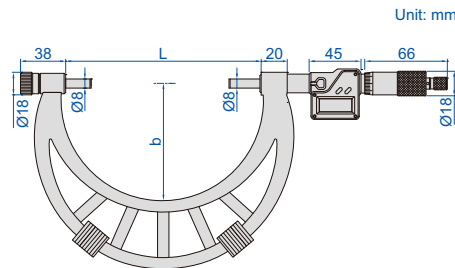

type B

Unit: mm

- Resolution 0.001mm/0.0001"
(resolution of **3506-100A** and **3506-150A** is 0.001mm/0.00005")
- IP65 dust/waterproof
- Button function: on/off, set, mm/inch, data transmit
- Data output
- Automatic power off
- Ratchet stop
- Carbide measuring faces
- Supplied with setting standards
- Optional accessory: data output cable (code **7315-31** page 4, **7302-31** page 12)

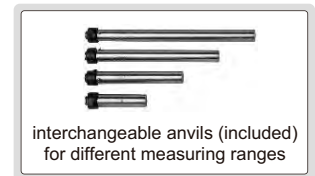

(mm)

Code	Range	Type	Accuracy	L	b	Setting standard (included)
3506-100A	0-100mm/0-4"	A	±5µm	105	57	25, 50, 75
3506-150A	0-150mm/0-6"	A	±6µm	155	82	25, 50, 75, 100, 125
3506-300A	150-300mm/6-12"	A	±8µm	305	165	150, 175, 200, 225, 250, 275
3506-301A	200-300mm/8-12"	A	±8µm	305	165	200, 225, 250, 275
3506-400A	300-400mm/12-16"	B	±9µm	405	224	325, 375
3506-500A	400-500mm/16-20"	B	±11µm	505	275	425, 475
3506-600A	500-600mm/20-24"	B	±12µm	605	321	525, 575
3506-700A	600-700mm/24-28"	B	±13µm	705	371	625, 675
3506-800A	700-800mm/28-32"	B	±15µm	805	426	725, 775
3506-900A	800-900mm/32-36"	B	±16µm	905	476	825, 875
3506-1000A	900-1000mm/36-40"	B	±17µm	1005	576	925, 975

OUTSIDE MICROMETERS WITH INTERCHANGEABLE ANVILS

INSIZE PLUS
MADE IN EUROPE

ATTENTION: SETTING
STANDARDS ARE NOT INCLUDED

LIGHT
WEIGHT

QUICK MEASUREMENT
ONE TURN OF SLEEVE OR RATCHET
STOP MAKES 1MM SPINDLE FEED

6



3675-300

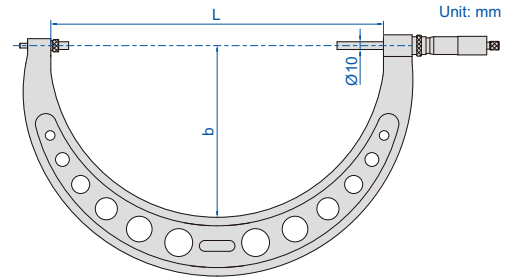

- Graduation 0.01mm
- Ratchet stop
- Meet DIN863-3
- Carbide measuring faces
- Light weight
- Optional accessory: setting standards (code 7386)

interchangeable anvil (included)
for different measuring ranges



Code	Range	Accuracy	L	b	Weight
3675-200	100-200mm	6μm	240	122	1.2kg
3675-300	200-300mm	6μm	325	165	1.5kg
3675-400	300-400mm	7μm	430	220	1.9kg
3675-500	400-500mm	8μm	530	273	2.4kg
3675-600	500-600mm	9μm	630	323	3.1kg
3675-700	600-700mm	9μm	730	378	3.8kg
3675-800	700-800mm	9μm	830	423	4.2kg
3675-900	800-900mm	10μm	930	473	5kg
3675-1000	900-1000mm	10μm	1030	520	6.2kg
3675-1100	1000-1100mm	11μm	1135	585	7.6kg
3675-1200	1100-1200mm	11μm	1230	635	8.6kg
3675-1300	1200-1300mm	12μm	1335	685	9.7kg
3675-1400	1300-1400mm	12μm	1430	735	11.3kg
3675-1500	1400-1500mm	13μm	1530	780	12.5kg
3675-1600	1500-1600mm	18μm	1660	840	13.6kg
3675-1700	1600-1700mm	19μm	1765	890	14.9kg
3675-1800	1700-1800mm	20μm	1870	940	16.2kg
3675-1900	1800-1900mm	21μm	1970	1000	17.5kg
3675-2000	1900-2000mm	22μm	2075	1055	18.8kg

(mm)

OUTSIDE MICROMETERS WITH EXTENSION ANVIL COLLAR

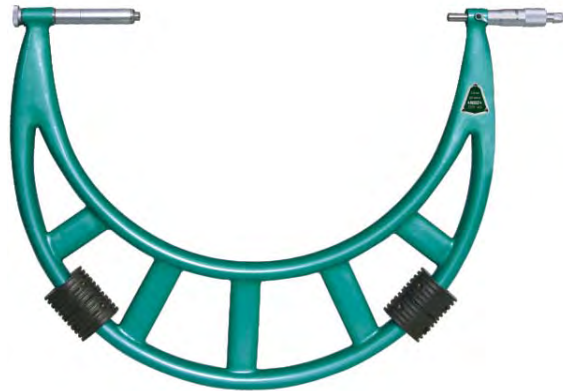

3205-400

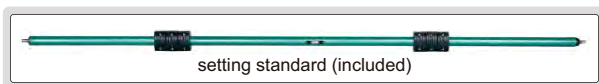

- Graduation 0.01mm
- Adjust collars for different measuring ranges
- Ratchet stop
- Carbide measuring faces
- Supplied with setting standards

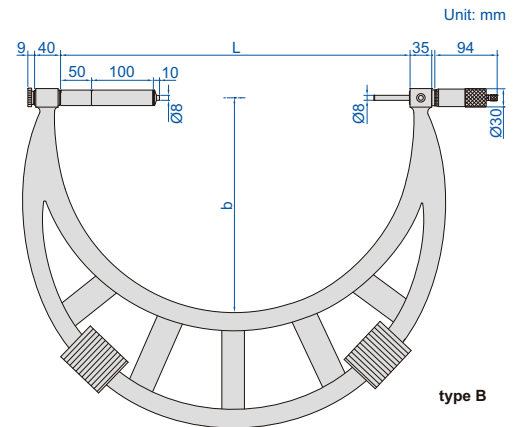
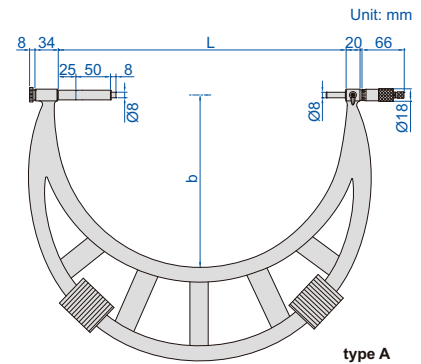

(mm)

Code	Range	Type	Accuracy	L	b	Setting standard (included)
3205-400	300-400mm	A	11µm	410	250	325, 375
3205-500	400-500mm	A	13µm	510	295	425, 475
3205-600	500-600mm	A	14µm	610	345	525, 575
3205-700	600-700mm	A	16µm	710	395	625, 675
3205-800	700-800mm	A	18µm	810	445	725, 775,
3205-900	800-900mm	A	20µm	910	495	825, 875
3205-1000	900-1000mm	A	22µm	1010	545	925, 975
3205-1200	1000-1200mm	B	22µm	1210	645	1050, 1150
3205-1400	1200-1400mm	B	24µm	1410	745	1250, 1350
3205-1600	1400-1600mm	B	28µm	1610	845	1450, 1550
3205-1800	1600-1800mm	B	31µm	1810	945	1650, 1750
3205-2000	1800-2000mm	B	34µm	2010	1045	1850, 1950



adjust collars for different measuring ranges

LIMIT MICROMETERS

- Used as Go/No-Go gage by setting upper and lower limits
- Graduation 0.002mm
- Carbide measuring faces
- Supplied with setting standard (except 0-25mm)

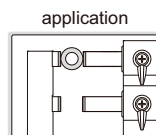

3235-25A

Code	Range	Accuracy	L	a	b
3235-25A	0-25mm	4µm	32mm	12mm	24mm
3235-50A	25-50mm	4µm	57mm	15mm	32mm

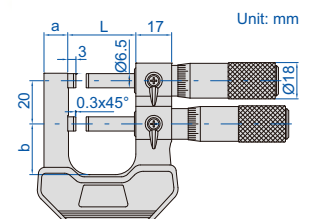

INDICATING MICROMETERS

ATTENTION: SETTING STANDARDS ARE NOT INCLUDED



3332-25

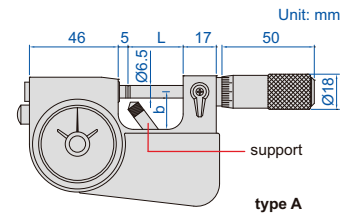

type A



3332-25B

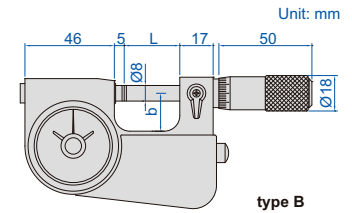

type B

- Meet DIN863-3
- Micrometer head graduation: 0.002mm
- Dial indicator: range ± 0.04 mm, graduation 0.001mm, accuracy 0.001mm
- Carbide measuring faces
- Optional accessory: gage blocks grade 0 (4101-A series), for zero setting

(mm)

Code	Micrometer head range	Micrometer head accuracy	Type	L	b	Remark
3332-25	0-25mm	4 μ m	A	28.5	19	with support
3332-50	25-50mm	4 μ m	A	53.5	30	with support
3332-75	50-75mm	5 μ m	A	78.5	45	without support
3332-100	75-100mm	5 μ m	A	103.5	57	without support
3332-25B	0-25mm	4 μ m	B	28.5	19	without support

MICROMETERS WITH DIAL INDICATOR

INSIZE PLUS
MADE IN EUROPE

ATTENTION: SETTING STANDARDS ARE NOT INCLUDED

INSPECTION CERTIFICATE

digital indicator is optional



3346-25

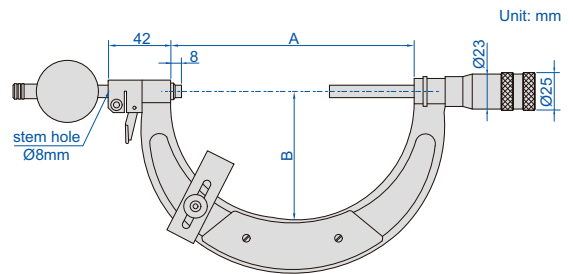

(mm)

Code	Micrometer head range	Micrometer head graduation	Micrometer head accuracy	A	B
3346-25*	0-25mm	5 μ m	4 μ m	37	24
3346-50*	25-50mm	5 μ m	4 μ m	62	34
3346-75*	50-75mm	5 μ m	5 μ m	87	46
3346-100*	75-100mm	5 μ m	5 μ m	112	60
3346-150*	100-150mm	5 μ m	6 μ m	164	85
3346-200*	150-200mm	5 μ m	7 μ m	215	110
3346-250*	200-250mm	5 μ m	8 μ m	264	135
3346-300*	250-300mm	5 μ m	9 μ m	315	160

- Anvil retracting range: 2.5mm
- Carbide measuring faces
- Parallelism of measuring faces: 1 μ m
- Optional accessory: dial indicator (code 2890-1F), digital indicator, gage blocks grade 1 (4101-B series), for zero setting

* Supplied with manufacturer inspection certificate

ATTENTION: SETTING
STANDARDS ARE NOT INCLUDED

LIGHT
WEIGHT

MICROMETERS WITH DIAL INDICATOR

INSIZE PLUS
MADE IN EUROPE

digital indicator
is optional



3685-300

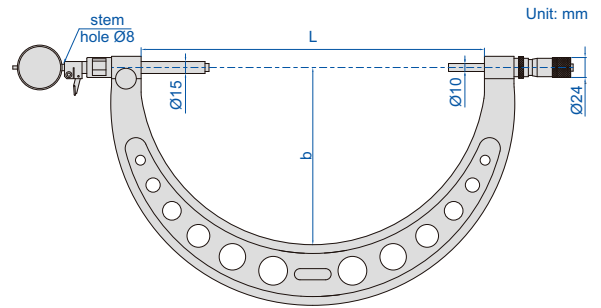

6

- Graduation 0.01mm
- Anvil with vernier graduation, convenient adjustment for different measuring ranges
- Meet DIN863-3
- Carbide measuring faces
- Anvil retracting range: 2.5mm
- Optional accessory: dial/digital indicators, setting standards (code **7386**)

anvil with vernier graduation,
can be adjusted for different measuring ranges



Range 100mm

(mm)

Code	Range	Micrometer head accuracy	L	b	Weight
3685-300	200-300mm	6µm	320	165	1.7kg
3685-400	300-400mm	7µm	430	220	2.1kg
3685-500	400-500mm	8µm	530	273	2.6kg
3685-600	500-600mm	9µm	630	323	3.3kg
3685-700	600-700mm	9µm	730	378	4.0kg
3685-800	700-800mm	9µm	830	423	4.4kg
3685-900	800-900mm	10µm	930	473	5.2kg
3685-1000	900-1000mm	10µm	1030	520	6.4kg

Range 200mm

(mm)

Code	Range	Micrometer head accuracy	L	b	Weight
3685-402	200-400mm	7µm	430	220	2.2kg
3685-602	400-600mm	9µm	630	323	3.4kg
3685-802	600-800mm	9µm	830	423	4.5kg
3685-1002	800-1000mm	10µm	1030	520	6.5kg
3685-1202	1000-1200mm	11µm	1230	635	8.9kg
3685-1402	1200-1400mm	12µm	1430	735	11.6kg
3685-1602	1400-1600mm	18µm	1660	840	13.9kg
3685-1802	1600-1800mm	20µm	1870	940	16.5kg
3685-2002	1800-2000mm	22µm	2075	1055	19.1kg

MICROMETERS WITH DIAL INDICATOR

ATTENTION: NOT SUITABLE FOR 0.001MM DIAL INDICATORS

- Meet DIN863-3
- Micrometer head graduation 0.01mm
- Anvil retracting range: 8mm
- Carbide measuring faces
- Supplied with setting standards (except 0-25mm)
- Optional accessory: dial indicators (graduation 0.01mm), digital indicators (resolution 0.01mm/0.0005")



digital indicator is optional

3331-25A

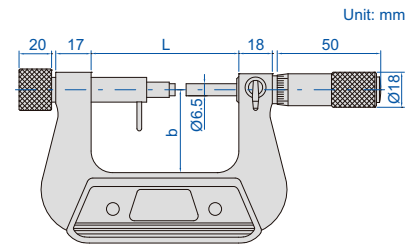

Code	Micrometer head range	Micrometer head accuracy	L	b
3331-25A	0-25mm	4µm	67mm	38mm
3331-50A	25-50mm	4µm	92.4mm	50mm
3331-75A	50-75mm	5µm	117.6mm	62mm
3331-100A	75-100mm	5µm	143mm	70mm
3331-125A	100-125mm	6µm	168.2mm	82mm
3331-150A	125-150mm	6µm	192mm	94.5mm
3331-175A	150-175mm	7µm	217mm	107mm

MICROMETERS WITH DIAL INDICATOR

ATTENTION: NOT SUITABLE FOR 0.001MM DIAL INDICATORS



digital indicator is optional

3296-100A

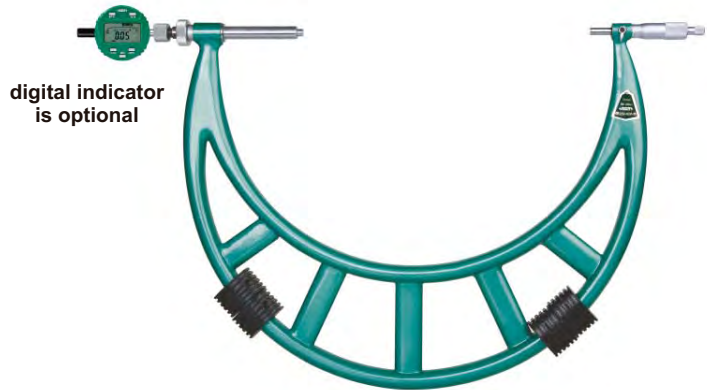

digital indicator is optional

3296-400A

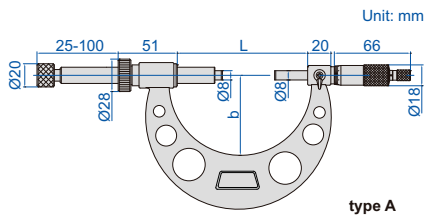

type A

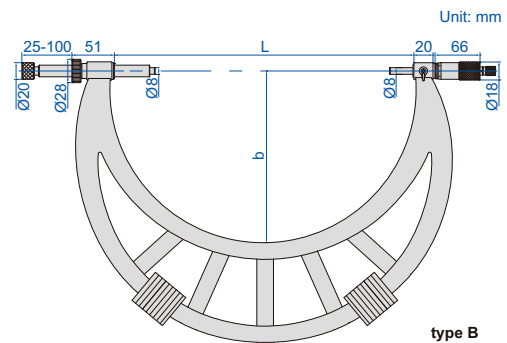

type B

Code	Range	Type	Accuracy	L	b
3296-100A	0-100mm	A	6µm	115	68
3296-200A	100-200mm	A	7µm	215	120
3296-300A	200-300mm	A	8µm	315	170
3296-400A	300-400mm	B	9µm	415	225
3296-500A	400-500mm	B	10µm	515	275
3296-600A	500-600mm	B	11µm	615	325
3296-700A	600-700mm	B	12µm	715	375
3296-800A	700-800mm	B	13µm	815	430
3296-900A	800-900mm	B	14µm	915	480
3296-1000A	900-1000mm	B	15µm	1015	530

(mm)

- Meet DIN863-3
- Graduation 0.01mm
- Ratchet stop
- Carbide measuring faces
- Supplied with setting standards
- Optional accessory: dial indicators (graduation 0.01mm), digital indicators (resolution 0.01mm/0.0005")

GROOVE MICROMETERS



3287-50B

- Measure width of grooves inside bores
- Graduation 0.01mm
- Two graduations for inside and outside measurements
- Non-rotating spindle
- Two-directional ratchet stop

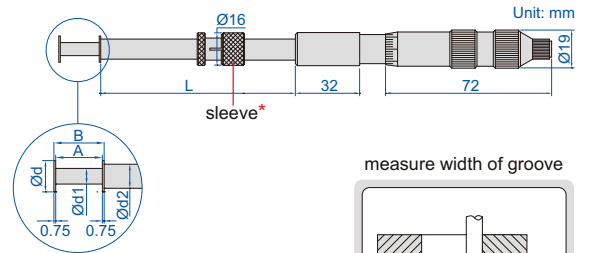

measure width of groove

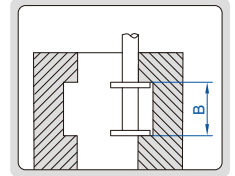

(mm)

measure width of keyway

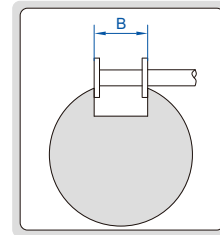

measure position of groove

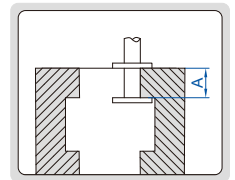

Code	Range (outside A)	Range (inside B)	Accuracy	L	Ød	Ød1	Ød2
3287-25B	0-25mm	1.6-26.5mm	10µm	120	13	6.5	10
3287-50B	25-50mm	26.5-51.5mm	10µm	120	13	6.5	10
3287-75B	50-75mm	51.5-76.5mm	10µm	120	13	6.5	10
3287-100B	75-100mm	76.5-101.5mm	10µm	120	13	6.5	10
3287-251B*	0-25mm	1.6-26.5mm	10µm	90	6.5	3	5

*3287-251B does not have sleeve



3-WIRES

application



- Used with standard outside micrometers to measure pitch diameter of screw threads
- Diameter accuracy: ±0.5µm
- Cylindricity: 1µm
- Hardness: HRC60
- Supplied with manufacturer inspection certificate



7382-19

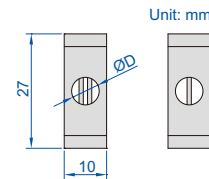

For outside micrometers with spindle Ø6.35mm (ØD)

Code	Pin gage diameter	Applicable pitch
7382-11	Ø0.170mm	0.2mm, 0.25mm, 0.3mm
7382-12	Ø0.195mm	0.35mm
7382-13	Ø0.220mm	0.4mm
7382-14	Ø0.250mm	0.45mm
7382-15	Ø0.290mm	0.5mm
7382-16	Ø0.335mm	0.6mm
7382-17	Ø0.390mm	0.7mm
7382-18	Ø0.455mm	0.75mm, 0.8mm
7382-19	Ø0.530mm	0.9mm
7382-110	Ø0.620mm	1.0mm
7382-111	Ø0.725mm	1.25mm
7382-112	Ø0.895mm	1.5mm
7382-113	Ø1.100mm	1.75mm, 2.0mm
7382-114	Ø1.350mm	2.5mm
7382-115	Ø1.650mm	3.0mm
7382-116	Ø2.050mm	3.5mm
7382-117	Ø2.550mm	4mm, 4.5mm
7382-118	Ø3.200mm	5mm, 5.5mm, 6mm
7382-1S	18 pairs/set, including all above 3-wires	

For outside micrometers with spindle Ø6.50mm (ØD)

Code	Pin gage diameter	Applicable pitch
7382-21	Ø0.170mm	0.2mm, 0.25mm, 0.3mm
7382-22	Ø0.195mm	0.35mm
7382-23	Ø0.220mm	0.4mm
7382-24	Ø0.250mm	0.45mm
7382-25	Ø0.290mm	0.5mm
7382-26	Ø0.335mm	0.6mm
7382-27	Ø0.390mm	0.7mm
7382-28	Ø0.455mm	0.75mm, 0.8mm
7382-29	Ø0.530mm	0.9mm
7382-210	Ø0.620mm	1.0mm
7382-211	Ø0.725mm	1.25mm
7382-212	Ø0.895mm	1.5mm
7382-213	Ø1.100mm	1.75mm, 2.0mm
7382-214	Ø1.350mm	2.5mm
7382-215	Ø1.650mm	3.0mm
7382-216	Ø2.050mm	3.5mm
7382-217	Ø2.550mm	4mm, 4.5mm
7382-218	Ø3.200mm	5mm, 5.5mm, 6mm
7382-2S	18 pairs/set, including all above 3-wires	

CARBIDE 3-WIRES

CUSTOMIZABLE DIAMETER Ød

INSPECTION CERTIFICATE

6

- When Ød ≤ 0.3mm, length L = 25mm;
When Ød > 0.3mm, length L = 45mm
- Made of carbide
- Hardness HRA90
- Diameter accuracy: ±0.5µm
- Roundness: 0.5µm
- Cylindricity: 1µm
- Supplied with manufacturer inspection certificate

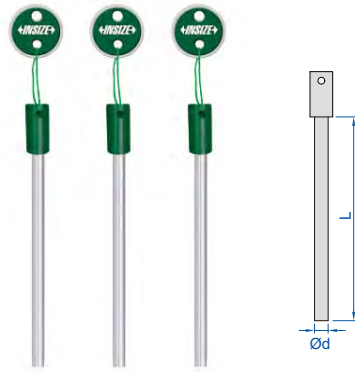

7394-76A

Code	Diameter (Ød)	Applicable pitch
7394-60A	0.170mm	0.2mm, 0.25mm, 0.3mm
7394-61A	0.195mm	0.35mm
7394-62A	0.220mm	0.4mm
7394-63A	0.250mm	0.45mm
7394-64A	0.290mm	0.5mm
7394-65A	0.335mm	0.6mm
7394-66A	0.390mm	0.7mm
7394-67A	0.455mm	0.75mm, 0.8mm
7394-68A	0.530mm	0.9mm
7394-69A	0.620mm	1.0mm
7394-70A	0.725mm	1.25mm
7394-71A	0.895mm	1.5mm
7394-72A	1.100mm	1.75mm, 2.0mm
7394-73A	1.350mm	2.5mm
7394-74A	1.650mm	3.0mm
7394-75A	2.050mm	3.5mm
7394-76A	2.550mm	4mm, 4.5mm
7394-77A	3.200mm	5mm, 5.5mm, 6mm

EXTERNAL SCREW THREAD MICROMETERS

INSIZE PLUS
MADE IN EUROPE

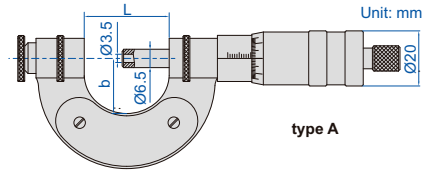

type A

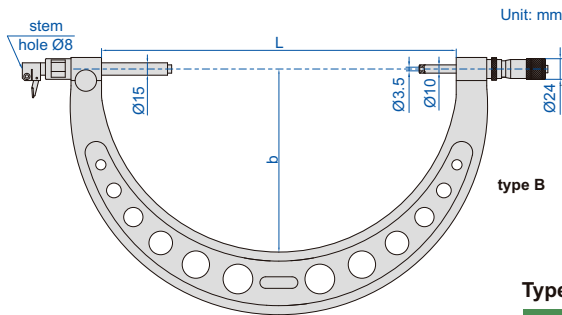
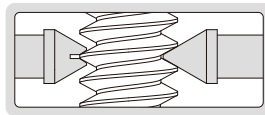

type B

- Measure pitch diameter of screw threads
- Graduation 0.01mm
- Optional accessory: setting standards (code 7384), external tread tips (code 7390), dial/digital indicators (only for type B)

Type A (ratchet stop) (mm)

Code	Range	Accuracy	L	b
3680-25 *	0-25mm	4µm	37	24
3680-50 *	25-50mm	4µm	62	34
3680-75 *	50-75mm	4µm	87	46
3680-100 *	75-100mm	4µm	112	60
3680-125 *	100-125mm	5µm	139	72
3680-150 *	125-150mm	5µm	164	85
3680-200 *	150-200mm	7µm	215	110
3680-250 *	200-250mm	7µm	264	135
3680-300 *	250-300mm	7µm	315	160

* Supplied with manufacturer inspection certificate

tips are optional



3680-50

tips are optional

digital indicator is optional



3680-4001

INSPECTION CERTIFICATE

Type B (without ratchet stop)

(mm)

Code	Range	Left anvil retracting stroke	Micrometer head accuracy	L	b
3680-3001 *	200-300mm	2.5mm	6µm	320	165
3680-4001 *	300-400mm	2.5mm	7µm	430	220
3680-5001 *	400-500mm	2.5mm	8µm	530	273
3680-6001 *	500-600mm	2.5mm	9µm	630	323
3680-7001 *	600-700mm	2.5mm	9µm	730	378
3680-8001 *	700-800mm	2.5mm	9µm	830	423
3680-9001 *	800-900mm	2.5mm	10µm	930	473
3680-10001 *	900-1000mm	2.5mm	10µm	1030	520
3680-4002 *	200-400mm	2.5mm	7µm	430	220
3680-6002 *	400-600mm	2.5mm	9µm	630	323
3680-8002 *	600-800mm	2.5mm	9µm	830	423
3680-10002 *	800-1000mm	2.5mm	10µm	1030	520
3680-12002 *	1000-1200mm	2.5mm	11µm	1230	635
3680-14002 *	1200-1400mm	2.5mm	12µm	1430	735
3680-16002 *	1400-1600mm	2.5mm	18µm	1660	840
3680-18002 *	1600-1800mm	2.5mm	20µm	1870	940
3680-20002 *	1800-2000mm	2.5mm	22µm	2075	1055

MEASURING TIPS FOR EXTERNAL SCREW THREAD MICROMETERS

INSIZE PLUS
MADE IN EUROPE

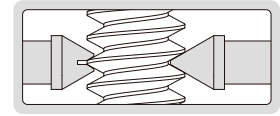
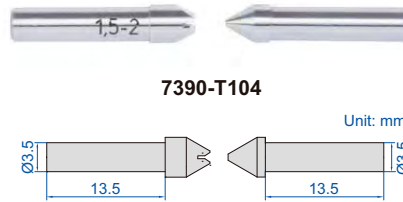

- Supplied in pair
- Made of hardened steel
- Suitable for 3680 series micrometers

6

60° thread angle

Code	Pitch
7390-T101	0.35-0.5mm/ 72-48TPI
7390-T102	0.6-0.8mm/ 44-32TPI
7390-T103	0.9-1.25mm/ 28-18TPI
7390-T104	1.5-2mm/ 16-11TPI
7390-T105	2.5-3.5mm/ 10-7TPI
7390-T106	4-6mm/ 6-4TPI

55° thread angle

Code	Pitch
7390-T201	60-48TPI
7390-T202	40-32TPI
7390-T203	28-22TPI
7390-T204	20-16TPI
7390-T205	14-11TPI
7390-T206	10-7TPI
7390-T207	6-4TPI

30° thread angle

Code	Pitch
7390-T301	1.5mm
7390-T302	2mm
7390-T303	3mm
7390-T304	4mm
7390-T305	5-6mm
7390-T306	7-8mm
7390-T307	9-10mm
7390-T308	12-14mm

SETTING STANDARDS FOR EXTERNAL SCREW THREAD MICROMETERS

ATTENTION: WHEN PITCH <0.4MM OR >63.5 TPI,
SETTING STANDARDS CANNOT BE USED TO SET ZERO,
A CALIBRATED WORK PIECE CAN BE USED INSTEAD

INSIZE PLUS
MADE IN EUROPE

TIPS FOR TRAPEZOIDAL, ACME
THREAD ARE ALSO AVAILABLE



7384-A100

- Made of hardened steel
- Deviation (difference between the ordered size and the size marked on the setting standard when supplied): $\pm 20\mu\text{m}$
For example, the ordered size is 25mm, the size marked on the setting standard when supplied may be 25.015mm

60° thread angle

(mm)

Code	L	Ød	Accuracy
7384-A25	25	7.8	$\pm 2.5\mu\text{m}$
7384-A50	50	7.8	$\pm 3\mu\text{m}$
7384-A75	75	7.8	$\pm 3.5\mu\text{m}$
7384-A100	100	7.8	$\pm 4\mu\text{m}$
7384-A125	125	7.8	$\pm 4.5\mu\text{m}$
7384-A150	150	7.8	$\pm 5\mu\text{m}$
7384-A175	175	7.8	$\pm 5.5\mu\text{m}$
7384-A200	200	7.8	$\pm 6\mu\text{m}$
7384-A225	225	10	$\pm 6.5\mu\text{m}$
7384-A250	250	10	$\pm 7\mu\text{m}$
7384-A275	275	10	$\pm 7.5\mu\text{m}$
7384-A300	300	10	$\pm 8\mu\text{m}$

55° thread angle

(mm)

Code	L	Ød	Accuracy
7384-B25	25	7.8	$\pm 2.5\mu\text{m}$
7384-B50	50	7.8	$\pm 3\mu\text{m}$
7384-B75	75	7.8	$\pm 3.5\mu\text{m}$
7384-B100	100	7.8	$\pm 4\mu\text{m}$
7384-B125	125	7.8	$\pm 4.5\mu\text{m}$
7384-B150	150	7.8	$\pm 5\mu\text{m}$
7384-B175	175	7.8	$\pm 5.5\mu\text{m}$
7384-B200	200	7.8	$\pm 6\mu\text{m}$
7384-B225	225	10	$\pm 6.5\mu\text{m}$
7384-B250	250	10	$\pm 7\mu\text{m}$
7384-B275	275	10	$\pm 7.5\mu\text{m}$
7384-B300	300	10	$\pm 8\mu\text{m}$

SCREW THREAD MICROMETERS

NON-ROTATING SPINDLE

6



3281-25A
(measuring tips are optional)



3281-S25
(measuring tips are included)

- Measure pitch diameter of screw threads
- Graduation 0.01mm
- Non-rotating spindle
- Ratchet stop
- Supplied with 60° setting standards (except 0-25mm)
- Optional accessory: 55° setting standards

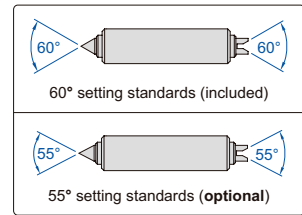
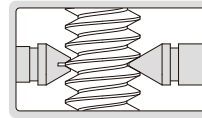

Measuring tips are optional (mm)

Code	Range	L	b	55° setting standard (optional)
3281-25A	0-25mm	42	26	-
3281-50A	25-50mm	67	38	3281-SP1
3281-75A	50-75mm	92	50	3281-SP2
3281-100A	75-100mm	117.6	62	3281-SP3
3281-125A	100-125mm	143	70	3281-SP4
3281-150A	125-150mm	168.2	82	3281-SP5
3281-175A	150-175mm	192	94.5	3281-SP6
3281-200A	175-200mm	217	107	3281-SP7
3281-225A	200-225mm	242	130	3281-SP8
3281-250A	225-250mm	267	142	3281-SP9
3281-275A	250-275mm	291	155	3281-SP10
3281-300A	275-300mm	317	167	3281-SP11

Measuring tips are included (mm)

Code	Range	L	b	Measuring tips (included)	55° setting standard (optional)
3281-S25	0-25mm	42	26	6 pairs of measuring tips: metric and unified thread (60° thread angle) 0.4-0.5mm/64-48TPI, 0.6-0.9mm/44-28TPI, 1-1.75mm/24-14TPI, 2-3mm/13-9TPI, 3.5-5mm/8-5TPI, 5.5-7mm/4.5-3.5TPI	-
3281-S50	25-50mm	67	38		3281-SP1
3281-S75	50-75mm	92	50		3281-SP2
3281-S100	75-100mm	117.6	62		3281-SP3
3281-S125	100-125mm	143	70		3281-SP4
3281-S150	125-150mm	168.2	82		3281-SP5
3281-S175	150-175mm	192	94.5		3281-SP6
3281-S200	175-200mm	217	107		3281-SP7
3281-S225	200-225mm	242	130		3281-SP8
3281-S250	225-250mm	267	142		3281-SP9
3281-S275	250-275mm	291	155		3281-SP10
3281-S300	275-300mm	317	167	3281-SP11	

accuracy of micrometers with tips (mm)

Pitch	Range							
	0-25	25-50	50-75	75-100	100-125	125-200	200-225	225-300
0.4-0.5	±0.01	-	-	-	-	-	-	-
0.6-0.8	±0.01	±0.013	-	-	-	-	-	-
1-1.25	±0.012	±0.015	±0.017	±0.017	-	-	-	-
1.5-2.0	±0.014	±0.017	±0.019	±0.019	±0.020	±0.023	±0.025	±0.028
2.5-3.5	±0.016	±0.019	±0.021	±0.021	±0.023	±0.025	±0.028	±0.031
4.0-7.0	-	±0.021	±0.023	±0.023	±0.025	±0.028	±0.031	±0.033

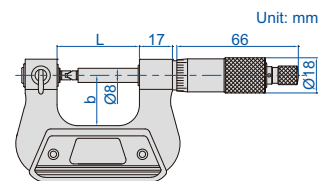

DATA
OUTPUT

NON-ROTATING
SPINDLE

DIGITAL SCREW THREAD MICROMETERS

6



3581-25A
(measuring tips are optional)



3581-S25
(measuring tips are included)

Measuring tips are optional

(mm)

Code	Range	L	b	55° setting standard (optional)
3581-25A	0-25mm/0-1"	42	26	-
3581-50A	25-50mm/1-2"	67	38	3281-SP1
3581-75A	50-75mm/2-3"	92	50	3281-SP2
3581-100A	75-100mm/3-4"	117.6	62	3281-SP3
3581-125A	100-125mm/4-5"	143	70	3281-SP4
3581-150A	125-150mm/5-6"	168.2	82	3281-SP5
3581-175A	150-175mm/6-7"	192	94.5	3281-SP6
3581-200A	175-200mm/7-8"	217	107	3281-SP7
3581-225A	200-225mm/8-9"	242	130	3281-SP8
3581-250A	225-250mm/9-10"	267	142	3281-SP9
3581-275A	250-275mm/10-11"	291	155	3281-SP10
3581-300A	275-300mm/11-12"	317	167	3281-SP11

- Measure pitch diameter of screw threads
- Resolution 0.001mm/0.00005"
- Button function: on/off, set, mm/inch, data transmit
- Data output
- Automatic power off
- Non-rotating spindle
- Ratchet stop
- Supplied with 60° setting standards (except 0-25mm/0-1")
- Optional accessory: 55° setting standards, data output cable (code 7315-31 page 4, 7302-31 page 12)

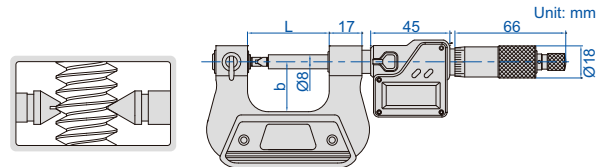

Measuring tips are included

(mm)

Code	Range	L	b	Measuring tips (included)	55° setting standard (optional)
3581-S25	0-25mm/0-1"	42	26	6 pairs of measuring tips: metric and unified thread (60° thread angle) 0.4-0.5mm/64-48TPI, 0.6-0.9mm/44-28TPI, 1-1.75mm/24-14TPI, 2-3mm/13-9TPI, 3.5-5mm/8-5TPI, 5.5-7mm/4.5-3.5TPI	-
3581-S50	25-50mm/1-2"	67	38		3281-SP1
3581-S75	50-75mm/2-3"	92	50		3281-SP2
3581-S100	75-100mm/3-4"	117.6	62		3281-SP3
3581-S125	100-125mm/4-5"	143	70		3281-SP4
3581-S150	125-150mm/5-6"	168.2	82		3281-SP5
3581-S175	150-175mm/6-7"	192	94.5		3281-SP6
3581-S200	175-200mm/7-8"	217	107		3281-SP7
3581-S225	200-225mm/8-9"	242	130		3281-SP8
3581-S250	225-250mm/9-10"	267	142		3281-SP9
3581-S275	250-275mm/10-11"	291	155		3281-SP10
3581-S300	275-300mm/11-12"	317	167	3281-SP11	

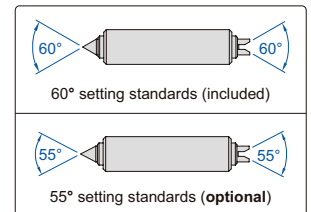

accuracy of micrometers with tips

(mm)

Pitch	Range							
	0-25	25-50	50-75	75-100	100-125	125-200	200-225	225-300
0.4~0.5	±0.01	-	-	-	-	-	-	-
0.6~0.8	±0.01	±0.013	-	-	-	-	-	-
1~1.25	±0.012	±0.015	±0.017	±0.017	-	-	-	-
1.5~2.0	±0.014	±0.017	±0.019	±0.019	±0.020	±0.023	±0.025	±0.028
2.5~3.5	±0.016	±0.019	±0.021	±0.021	±0.023	±0.025	±0.028	±0.031
4.0~7.0	-	±0.021	±0.023	±0.023	±0.025	±0.028	±0.031	±0.033

MEASURING TIPS FOR SCREW THREAD MICROMETERS

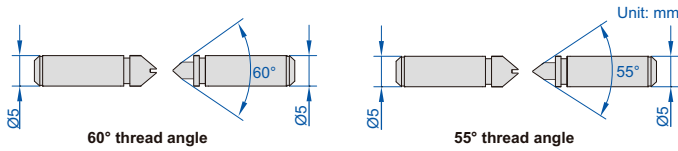

7381-T13

6

- Supplied in pair
- Suitable for 3281, 3581 series micrometers

Metric and unified thread (60° thread angle)

Code	Pitch
7381-T11	0.4-0.5mm/ 64-48TPI
7381-T12	0.6-0.9mm/ 44-28TPI
7381-T13	1-1.75mm/ 24-14TPI
7381-T14	2-3mm/ 13-9TPI
7381-T15	3.5-5mm/ 8-5TPI
7381-T16	5.5-7mm/ 4.5-3.5TPI
7381-TS	6 pairs/set, including all above tips

Whitworth thread (55° thread angle)

Code	Pitch
7381-T21	60-48TPI
7381-T22	48-40TPI
7381-T23	40-32TPI
7381-T24	32-24TPI
7381-T25	24-18TPI
7381-T26	18-14TPI
7381-T27	14-10TPI
7381-T28	10-7TPI
7381-T29	7-4.5TPI
7381-T210	4.5-3.5TPI
7381-T2S	10 pairs/set, including all above tips

EXTERNAL GEAR TOOTH MICROMETERS

INSIZE PLUS
MADE IN EUROPE

**INSPECTION
CERTIFICATE**

ATTENTION: SETTING
STANDARDS ARE NOT INCLUDED

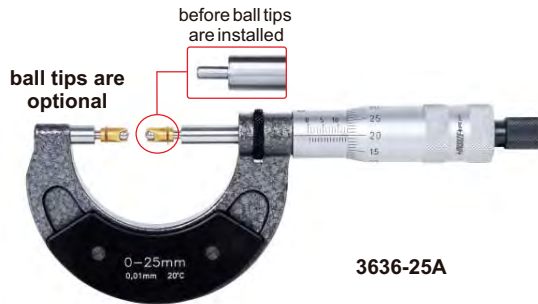

3636-25A

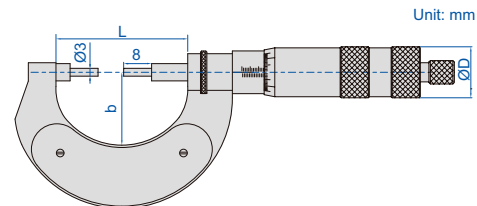

- Meet DIN863-3
- Measure over-pin diameter of gears
- Graduation 0.01mm
- Ratchet stop
- Optional accessory: ball tips (code 7389), cylindrical tips (code 7393), setting standards (code 7386)

cylindrical tips (optional)

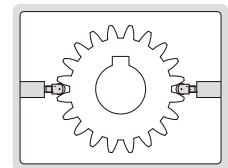

Code	Range	Accuracy	L	b	ØD
3636-25A*	0-25mm	3µm	62	34	20
3636-50A*	25-50mm	3µm	87	46	20
3636-75A*	50-75mm	4µm	112	60	20
3636-100A*	75-100mm	4µm	139	72	20
3636-125A*	100-125mm	5µm	164	85	20
3636-150A*	125-150mm	5µm	190	97	20
3636-175A*	150-175mm	5µm	215	110	20
3636-200A*	175-200mm	5µm	240	122	20

*Supplied with manufacturer inspection certificate

Code	Range	Accuracy	L	b	ØD
3636-225A*	200-225mm	6µm	264	135	20
3636-250A*	225-250mm	6µm	290	148	20
3636-300A*	250-300mm	6µm	325	165	24
3636-350A*	300-350mm	7µm	370	190	24
3636-400A*	350-400mm	7µm	430	220	24
3636-450A*	400-450mm	8µm	475	250	24
3636-500A*	450-500mm	8µm	530	273	24
3636-550A*	500-550mm	9µm	570	291	24
3636-600A*	550-600mm	9µm	630	323	24

**CYLINDRICAL DIAMETER
ØD CAN BE CUSTOMIZED**

CYLINDRICAL TIPS FOR GEAR TOOTH MICROMETERS

INSIZE PLUS
MADE IN EUROPE

- Supplied in pair
- Made of hardened steel
- Self-positioning
- Suitable for **3636, 3638, 3678,** series micrometers



7393-T5

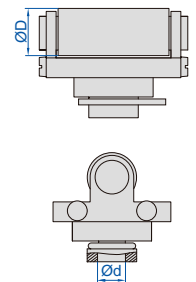

6

Code	Diameter of shaft (ØD)	Ød	Accuracy
7393-T1	1mm	3mm	±1µm
7393-T2	2mm	3mm	±1µm
7393-T3	3mm	3mm	±1µm
7393-T3D5	3.5mm	3mm	±1µm
7393-T4	4mm	3mm	±1µm
7393-T5	5mm	3mm	±1µm
7393-T6	6mm	3mm	±1µm
7393-T7	7mm	3mm	±1µm
7393-T8	8mm	3mm	±1µm

**BALL TIPS DIAMETER
SØD CAN BE CUSTOMIZED**

BALL TIPS FOR GEAR TOOTH MICROMETERS

INSIZE PLUS
MADE IN EUROPE

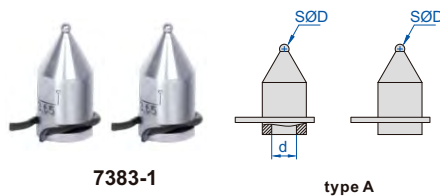

7383-1

type A

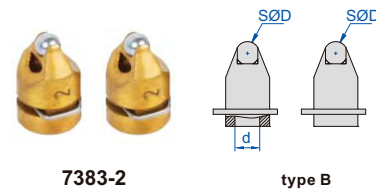

7383-2

type B

- Supplied in pair
- Made of hardened steel
- Suitable for **3636, 3638, 3678** series micrometers

Code	Ball dia. (SØD)	d	Accuracy	Type
7383-1	SØ1mm	Ø3mm	±1µm	A
7383-1D5	SØ1.5mm	Ø3mm	±1µm	B
7383-1D75	SØ1.75mm	Ø3mm	±1µm	B
7383-2	SØ2mm	Ø3mm	±1µm	B
7383-2D25	SØ2.25mm	Ø3mm	±1µm	B
7383-2D5	SØ2.5mm	Ø3mm	±1µm	B
7383-3	SØ3mm	Ø3mm	±1µm	B
7383-3D5	SØ3.5mm	Ø3mm	±1µm	B
7383-4	SØ4mm	Ø3mm	±1µm	B
7383-4D5	SØ4.5mm	Ø3mm	±1µm	B
7383-5	SØ5mm	Ø3mm	±1µm	B
7383-5D5	SØ5.5mm	Ø3mm	±1µm	B
7383-6	SØ6mm	Ø3mm	±1µm	B

Code	Ball dia. (SØD)	d	Accuracy	Type
7383-6D5	SØ6.5mm	Ø3mm	±1µm	B
7383-7	SØ7mm	Ø3mm	±1µm	B
7383-7D5	SØ7.5mm	Ø3mm	±1µm	B
7383-8	SØ8mm	Ø3mm	±1µm	B
7383-9	SØ9mm	Ø3mm	±1µm	B
7383-10	SØ10mm	Ø3mm	±1µm	B
7383-10D5	SØ10.5mm	Ø3mm	±1.5µm	B
7383-11	SØ11mm	Ø3mm	±1.5µm	B
7383-12	SØ12mm	Ø3mm	±1.5µm	B
7383-13	SØ13mm	Ø3mm	±1.5µm	B
7383-14	SØ14mm	Ø3mm	±1.5µm	B
7383-15	SØ15mm	Ø3mm	±1.5µm	B
7383-16	SØ16mm	Ø3mm	±1.5µm	B

GEAR TOOTH MICROMETERS

- Meet DIN863-3
- Measure over-pin diameter of gears
- Graduation 0.01mm
- Ratchet stop
- Supplied with setting standards (except 0-25mm)
- Optional accessory: ball tips (code 7391)

6

Code	Range	Accuracy	L	b
3291-25	0-25mm	4μm	67	38
3291-50	25-50mm	4μm	92.4	50
3291-75	50-75mm	5μm	117.6	62
3291-100	75-100mm	5μm	143	70
3291-125	100-125mm	6μm	168.2	82
3291-150	125-150mm	6μm	192	94.5
3291-175	150-175mm	7μm	217	107



3291-25

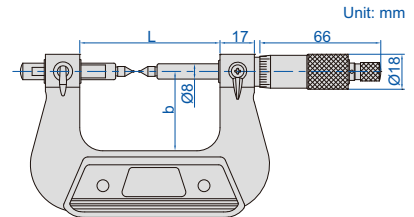
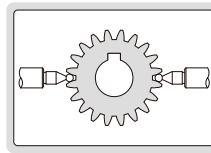

DIGITAL GEAR TOOTH MICROMETERS

IP65
WATERPROOF

DATA
OUTPUT

- Measure over-pin diameter of gears
- Resolution 0.001mm/0.00005"
- IP65 dust/waterproof
- Button function: on/off, set, mm/inch, data transmit
- Data output
- Automatic power off
- Ratchet stop
- Supplied with setting standards (except 0-25mm/0-1")
- Optional accessory: ball tips (code 7391), data output cable (code 7315-31 page 4, 7302-31 page 12)

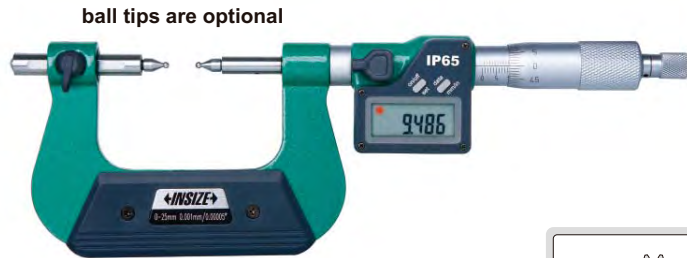

3591-25A

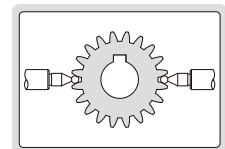

Code	Range	Accuracy	L	b
3591-25A	0-25mm/0-1"	±4μm	67	38
3591-50A	25-50mm/1-2"	±4μm	92.4	50
3591-75A	50-75mm/2-3"	±5μm	117.6	62
3591-100A	75-100mm/3-4"	±5μm	143	70
3591-125A	100-125mm/4-5"	±6μm	168.2	82
3591-150A	125-150mm/5-6"	±6μm	192	94.5
3591-175A	150-175mm/6-7"	±7μm	217	107

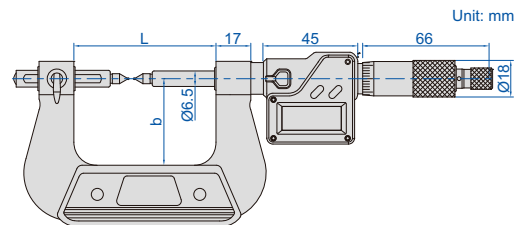

BALL TIPS FOR GEAR TOOTH MICROMETERS

BALL TIPS DIAMETER SØD CAN BE CUSTOMIZED WITH SIZES BETWEEN 1.50-6.00MM

- Supplied in pair
- Suitable for 3291, 3591 series micrometers

Code	Ball dia. (D)
7391-T2	SØ1.5mm
7391-T3	SØ2.0mm
7391-T4	SØ2.5mm
7391-T5	SØ3.0mm

Code	Ball dia. (D)
7391-T6	SØ3.5mm
7391-T7	SØ4.0mm
7391-T8	SØ4.5mm
7391-T9	SØ5.0mm
7391-T10	SØ6.0mm



7391-T5

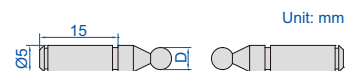

ATTENTION: SETTING STANDARDS ARE NOT INCLUDED

INSPECTION CERTIFICATE

POINT MICROMETERS

INSIZE PLUS
MADE IN EUROPE

Code	Range	Accuracy	L	b
3659-25A*	0-25mm	4µm	62	34
3659-50A*	25-50mm	4µm	87	46
3659-75A*	50-75mm	5µm	112	60
3659-100A*	75-100mm	5µm	139	72
3659-125A*	100-125mm	6µm	164	85
3659-150A*	125-150mm	6µm	190	97
3659-175A*	150-175mm	7µm	215	110
3659-200A*	175-200mm	7µm	240	122
3659-225A*	200-225mm	8µm	264	135
3659-250A*	225-250mm	8µm	290	148

* Supplied with manufacturer inspection certificate



3659-25A

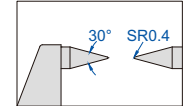
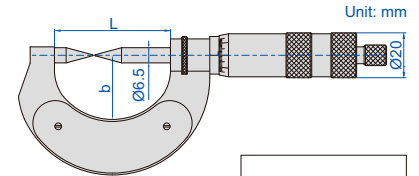

- Measure the web thickness of drills, small grooves and keyways
- Graduation: 0.01mm
- Ratchet stop
- Carbide tips
- Optional accessory: setting standards (code 7386)

6

POINT MICROMETERS

- Measure the web thickness of drills, small grooves and keyways
- Graduation 0.01mm
- Ratchet stop
- Carbide tips
- Supplied with setting standards (except 0-25mm)

Code	Range	Type	Accuracy	L	b
3230-25A	0-25mm	A	4µm	57	32
3230-50A	25-50mm	A	4µm	82	44.5
3230-75A	50-75mm	A	5µm	107	57
3230-100A	75-100mm	A	5µm	132.6	69.5
3230-25BA	0-25mm	B	4µm	57	32
3230-50BA	25-50mm	B	4µm	82	44.5
3230-75BA	50-75mm	B	5µm	107	57
3230-100BA	75-100mm	B	5µm	132.6	69.5



3230-25A

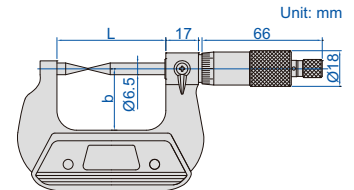

DIGITAL POINT MICROMETERS

- Measure the web thickness of drills, small grooves and keyways
- Resolution 0.001mm/0.00005"
- IP65 dust/waterproof
- Button function: on/off, set, mm/inch, data transmit
- Data output
- Automatic power off
- Ratchet stop
- Carbide tips
- Supplied with setting standards (except 0-25mm/0-1")
- Optional accessory: data output cable (code 7315-31 page 4, 7302-31 page 12)

Code	Range	Type	Accuracy	L	b
3530-25A	0-25mm/0-1"	A	±4µm	57	32
3530-50A	25-50mm/1-2"	A	±4µm	82	44.5
3530-75A	50-75mm/2-3"	A	±5µm	107	57
3530-100A	75-100mm/3-4"	A	±5µm	132.6	69.5
3530-25BA	0-25mm/0-1"	B	±4µm	57	32
3530-50BA	25-50mm/1-2"	B	±4µm	82	44.5
3530-75BA	50-75mm/2-3"	B	±5µm	107	57
3530-100BA	75-100mm/3-4"	B	±5µm	132.6	69.5



3530-25A

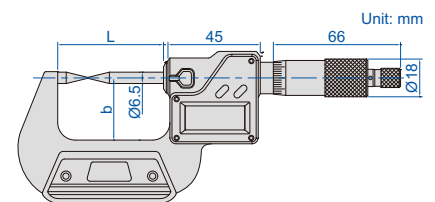
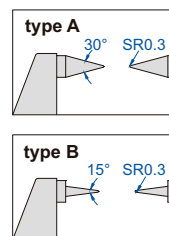

DATA OUTPUT

IP65 WATERPROOF

HIGH PRECISION DIGITAL POINT MICROMETERS/SNAP GAGES

ONE TURN OF SLEEVE MAKES 5MM SPINDLE FEED, PRESS THE FORK, THE SPINDLE RETRACTS 3MM

ABSOLUTE ENCODER, THE ORIGINAL DATA REMAINS AFTER POWER OFF

MEASUREMENT ACCURACY IS NOT AFFECTED BY THE USE OF SLEEVE

NON-ROTATING SPINDLE

DATA OUTPUT

ATTENTION: RECHARGEABLE BATTERY, FOR 24 HOURS CONTINUOUS WORKING

IP65 WATERPROOF



6



3354-25

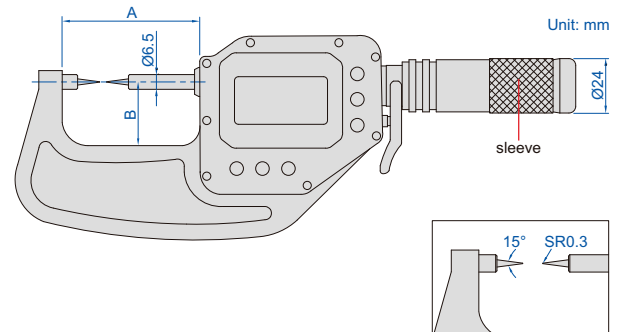

- Measure the web thickness of drills, small grooves and keyways
- Absolute encoder, the original data remains after power off
- Adjustable resolution: 0.0002mm/0.00001"
0.001mm/0.00005"
0.01mm/0.0005"
- One turn of sleeve makes 5mm spindle feed
- Measurement accuracy is not affected by the use of sleeve
- Press the fork, the spindle retracts 3mm
- Linear ball bearings for ten million times use
- Carbide spindle and anvil
- Measuring force 7-10N
Customizable measuring force range 2-12N
Attention: small measuring force will reduce the dustproof and waterproof level
- Button function: data output, tolerance, data preset, data hold, measuring direction change, max./min./TIR, power off time, on/off, zero, mm/inch, adjust resolution
- Supplied with gage blocks for zero setting (except 0-25mm/0-1")
- Power: rechargeable battery, for 24 hours continuous working

alarm when over tolerance

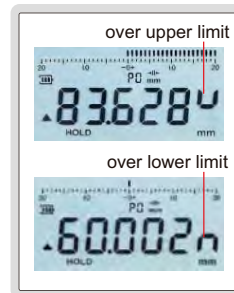

wireless receiver

2134-R1, 2134-R2 (optional)



With data interface

Optional accessory:

wireless transmitter, code 7315-3350 page 6

data output cable (keyboard format), code 7302-3350 page 13

Code	Range	Accuracy	Repeatability	A	B
3354-25 *	0-25mm/0-1"	2µm	1µm	63mm	25mm
3354-50 *	25-50mm/1-2"	2µm	1µm	88mm	42mm
3354-75 *	50-75mm/2-3"	2µm	1µm	113mm	56mm

Built-in wireless

Optional accessory:

wireless receiver (keyboard format, connect up to 15 digital indicators), code 2134-R1

wireless receiver (serial port format, connect up to 15 digital indicators), code 2134-R2

Code	Range	Accuracy	Repeatability	A	B
3354-25WL *	0-25mm/0-1"	2µm	1µm	63mm	25mm
3354-50WL *	25-50mm/1-2"	2µm	1µm	88mm	42mm
3354-75WL *	50-75mm/2-3"	2µm	1µm	113mm	56mm

*Supplied with manufacturer inspection certificate

GEAR ROOT DIAMETER MICROMETERS

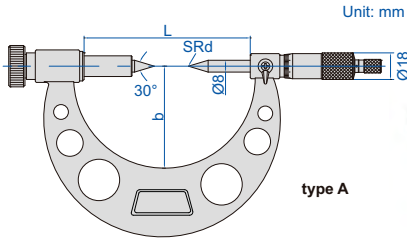

type A



3297-100



3297-300

- Measure diameter of gear root circle
- Graduation 0.01mm
- Ratchet stop
- Meet DIN863-3
- Carbide measuring faces
- Supplied with setting standards

Code	Range	Type	Accuracy	L	b	SRd
3297-100	5-100mm	A	5µm	137	72	0.4
3297-200	100-200mm	A	7µm	237	129	0.5
3297-300	200-300mm	B	9µm	414	225	0.7
3297-400	300-400mm	B	11µm	514	275	0.7
3297-500	400-500mm	B	13µm	614	325	0.7
3297-600	500-600mm	B	15µm	714	375	0.7
3297-700	600-700mm	B	16µm	814	425	0.7
3297-800	700-800mm	B	18µm	914	475	0.7
3297-900	800-900mm	B	20µm	1014	525	0.7

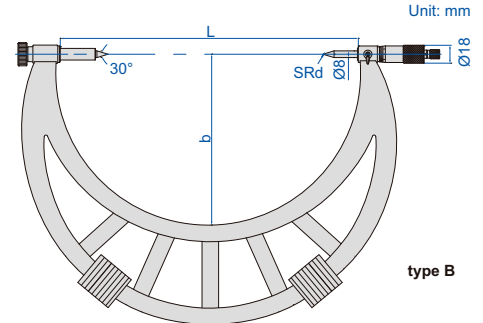

type B

IP65
WATERPROOF

DATA
OUTPUT

DIGITAL GEAR ROOT DIAMETER MICROMETERS

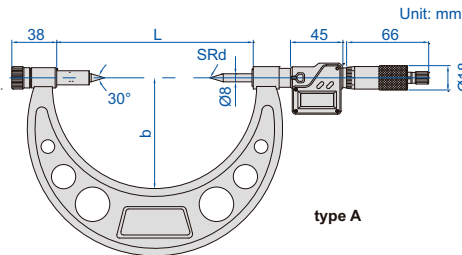

type A



3597-100

- Measure diameter of gear root circle
- Resolution 0.001mm/0.0001" (resolution of 3597-100 and 3597-200 is 0.001mm/0.00005")
- IP65 dust/waterproof
- Button function: on/off, set, mm/inch, data transmit
- Data output
- Automatic power off
- Ratchet stop
- Carbide measuring faces
- Supplied with setting standards
- Optional accessory: data output cable (code 7315-31 page 4, 7302-31 page 12)



3597-300

Code	Range	Type	Accuracy	L	b	SRd
3597-100	5-100mm	A	3µm	137	72	0.4
3597-200	100-200mm	A	4µm	237	129	0.5
3597-300	200-300mm	B	5µm	414	225	0.7
3597-400	300-400mm	B	6µm	514	275	0.7
3597-500	400-500mm	B	7µm	614	325	0.7
3597-600	500-600mm	B	8µm	714	375	0.7
3597-700	600-700mm	B	8µm	814	425	0.7
3597-800	700-800mm	B	9µm	914	475	0.7
3597-900	800-900mm	B	10µm	1014	525	0.7

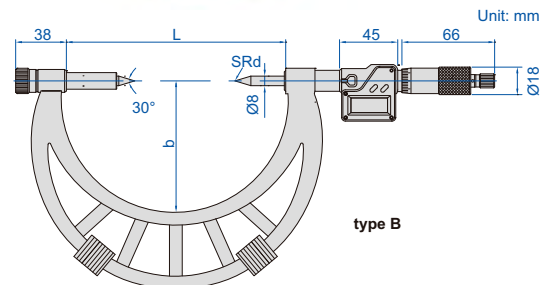

type B

BLADE MICROMETERS

INSIZE PLUS
MADE IN EUROPE



ATTENTION: SETTING
STANDARDS ARE NOT INCLUDED

6



3650-25A

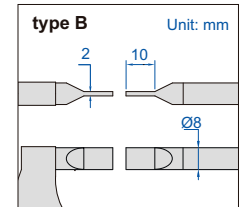
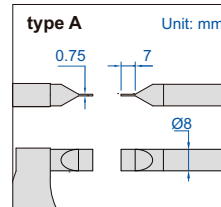
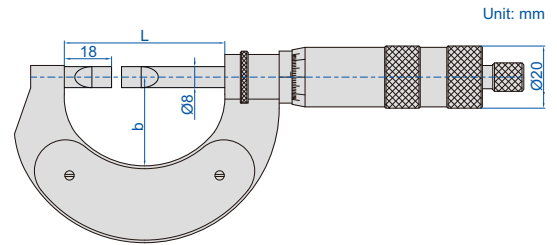
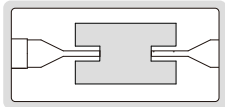

- Meet DIN863-3
- Graduation 0.01mm
- Force: 5-10N
- Optional accessory: setting standards (code 7386)

(mm)

Code	Range	Type	Accuracy	L	b
3650-25A*	0-25mm	A	4µm	62	34
3650-50A*	25-50mm	A	4µm	87	46
3650-75A*	50-75mm	B	5µm	112	60
3650-100A*	75-100mm	B	5µm	139	72
3650-125A*	100-125mm	B	6µm	164	85
3650-150A*	125-150mm	B	6µm	190	97
3650-175A*	150-175mm	B	7µm	215	110
3650-200A*	175-200mm	B	7µm	240	122
3650-225A*	200-225mm	B	8µm	264	135
3650-250A*	225-250mm	B	8µm	290	148
3650-275A*	250-275mm	B	9µm	315	160
3650-300A*	275-300mm	B	9µm	340	174

*Supplied with manufacturer inspection certificate

NON-ROTATING SPINDLE

BLADE MICROMETERS

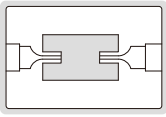

- Meet DIN863-3
- Measure the groove diameter of shafts and keyways
- Graduation 0.01mm
- Non-rotating spindle
- Ratchet stop
- Supplied with setting standards (except 0-25mm)



3232-25A

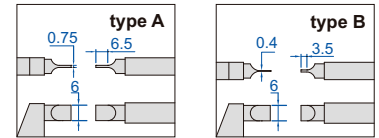
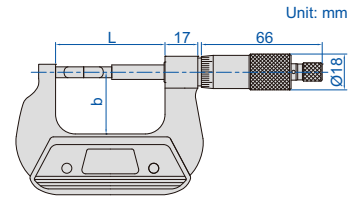

Type A		(mm)		
Code	Range	Accuracy	L	b
3232-25A	0-25mm	4µm	57	32
3232-50A	25-50mm	4µm	82	44.5
3232-75A	50-75mm	5µm	107	57
3232-100A	75-100mm	5µm	132.6	69.5
3232-125A	100-125mm	6µm	158	82
3232-150A	125-150mm	6µm	183.4	94.5
3232-175A	150-175mm	7µm	208.8	107
3232-200A	175-200mm	7µm	234.2	129.6
3232-225A	200-225mm	8µm	259.6	142.3
3232-250A	225-250mm	8µm	285	155
3232-275A	250-275mm	9µm	310.4	167.7
3232-300A	275-300mm	9µm	336.5	177.8

Type B		(mm)		
Code	Range	Accuracy	L	b
3232-25BA	0-25mm	4µm	57	32
3232-50BA	25-50mm	4µm	82	44.5
3232-75BA	50-75mm	5µm	107	57
3232-100BA	75-100mm	5µm	132.6	69.5
3232-125BA	100-125mm	6µm	158	82
3232-150BA	125-150mm	6µm	183.4	94.5
3232-175BA	150-175mm	7µm	208.8	107
3232-200BA	175-200mm	7µm	234.2	129.6
3232-225BA	200-225mm	8µm	259.6	142.3
3232-250BA	225-250mm	8µm	285	155
3232-275BA	250-275mm	9µm	310.4	167.7
3232-300BA	275-300mm	9µm	336.5	177.8

DATA OUTPUT

NON-ROTATING SPINDLE

DIGITAL BLADE MICROMETERS

- Measure the groove diameter of shafts and keyways
- Resolution 0.001mm/0.00005"
- Non-rotating spindle
- Button function: on/off, set, mm/inch, data transmit
- Data output
- Automatic power off
- Ratchet stop
- Supplied with setting standards (except 0-25mm/0-1")
- Optional accessory: data output cable (code 7315-31 page 4, 7302-31 page 12)



3532-25A

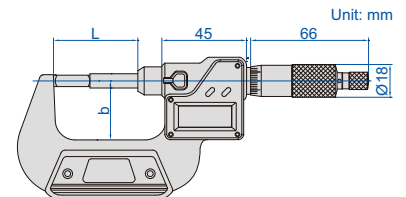

		(mm)			
Code	Range	Type	Accuracy	L	b
3532-25A	0-25mm/0-1"	A	±4µm	57	32
3532-50A	25-50mm/1-2"	A	±4µm	82	44.5
3532-75A	50-75mm/2-3"	A	±5µm	107	57
3532-100A	75-100mm/3-4"	A	±5µm	132.6	69.5
3532-125A	100-125mm/4-5"	A	±6µm	158	82
3532-150A	125-150mm/5-6"	A	±6µm	183.4	94.5
3532-175A	150-175mm/6-7"	A	±7µm	208.8	107
3532-25BA	0-25mm/0-1"	B	±4µm	57	32
3532-50BA	25-50mm/1-2"	B	±4µm	82	44.5
3532-75BA	50-75mm/2-3"	B	±5µm	107	57
3532-100BA	75-100mm/3-4"	B	±5µm	132.6	69.5
3532-125BA	100-125mm/4-5"	B	±6µm	158	82
3532-150BA	125-150mm/5-6"	B	±6µm	183.4	94.5
3532-175BA	150-175mm/6-7"	B	±7µm	208.8	107

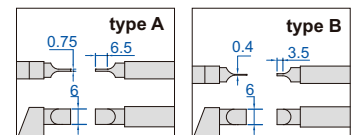
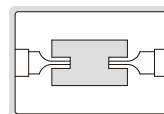

HIGH PRECISION DIGITAL BLADE MICROMETERS/SNAP GAGES



MEASUREMENT ACCURACY IS NOT AFFECTED BY THE USE OF SLEEVE

IP65
WATERPROOF

DATA
OUTPUT

ABSOLUTE ENCODER, THE ORIGINAL DATA REMAINS AFTER POWER OFF

NON-ROTATING
SPINDLE

ONE TURN OF SLEEVE MAKES 5MM SPINDLE FEED, PRESS THE FORK, THE SPINDLE RETRACTS 3MM

ATTENTION: RECHARGEABLE BATTERY, FOR 24 HOURS CONTINUOUS WORKING



3352-25A



- Measure the groove diameter of shafts and keyways
- Absolute encoder, the original data remains after power off
- Adjustable resolution: 0.0002mm/0.00001"
0.001mm/0.00005"
0.01mm/0.0005"
- One turn of sleeve makes 5mm spindle feed
- Measurement accuracy is not affected by the use of sleeve
- Press the fork, the spindle retracts 3mm
- Linear ball bearings for ten million times use
- Carbide spindle and anvil
- Measuring force 7-10N
Customizable measuring force range 2-12N
Attention: small measuring force will reduce the dustproof and waterproof level
- Button function: data output, tolerance, data preset, data hold, measuring direction change, max./min./TIR, power off time, on/off, zero, mm/inch, adjust resolution
- Supplied with gage blocks for zero setting (except 0-25mm/0-1")
- Power: rechargeable battery, for 24 hours continuous working

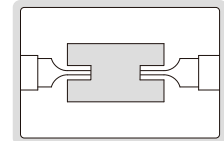
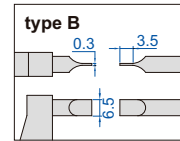
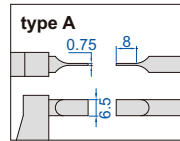
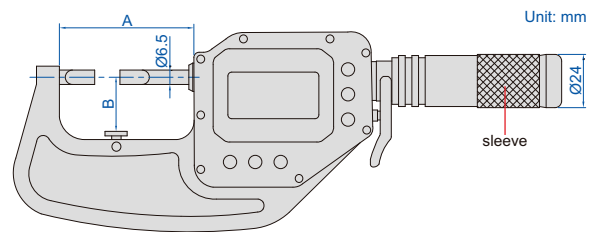

With data interface

Optional accessory:

wireless transmitter, code **7315-3350** page 6

data output cable (keyboard format), code **7302-3350** page 13

Code	Range	Type	Accuracy	Repeatability	A	B
3352-25A*	0-25mm/0-1"	A	2µm	1µm	63mm	25mm
3352-50A*	25-50mm/1-2"	A	2µm	1µm	88mm	42mm
3352-75A*	50-75mm/2-3"	A	2µm	1µm	113mm	56mm
3352-25B*	0-25mm/0-1"	B	2µm	1µm	63mm	25mm
3352-50B*	25-50mm/1-2"	B	2µm	1µm	88mm	42mm
3352-75B*	50-75mm/2-3"	B	2µm	1µm	113mm	56mm

Built-in wireless

Optional accessory:

wireless receiver (keyboard format, connect up to 15 digital indicators), code **2134-R1**

wireless receiver (serial port format, connect up to 15 digital indicators), code **2134-R2**

Code	Range	Type	Accuracy	Repeatability	A	B
3352-25AWL*	0-25mm/0-1"	A	2µm	1µm	63mm	25mm
3352-50AWL*	25-50mm/1-2"	A	2µm	1µm	88mm	42mm
3352-75AWL*	50-75mm/2-3"	A	2µm	1µm	113mm	56mm
3352-25BWL*	0-25mm/0-1"	B	2µm	1µm	63mm	25mm
3352-50BWL*	25-50mm/1-2"	B	2µm	1µm	88mm	42mm
3352-75BWL*	50-75mm/2-3"	B	2µm	1µm	113mm	56mm

*Supplied with manufacturer inspection certificate

alarm when
over tolerance

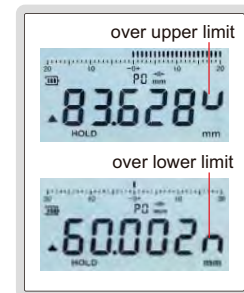

wireless receiver
2134-R1, 2134-R2 (optional)



RELATIVE PRODUCT: DIGITAL CRIMP HEIGHT CALIPER (CODE 1165-150A)

- Measure the height of crimp contact
- Graduation 0.01mm
- Ratchet stop
- Supplied with setting standards (except 0-25mm)

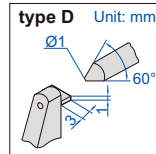
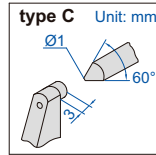
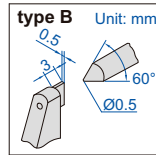

CRIMP HEIGHT MICROMETERS



3266-25BA

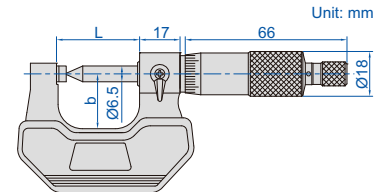

Code	Range	Type	Accuracy	L	b
3266-25BA	0-25mm	B	4µm	34	24
3266-25CA	0-25mm	C	4µm	34	24
3266-50CA	25-50mm	C	4µm	59	32
3266-75CA	50-75mm	C	5µm	85	45
3266-100CA	75-100mm	C	5µm	110	57
3266-25DA	0-25mm	D	4µm	34	24

IP65 WATERPROOF

DATA OUTPUT

RELATIVE PRODUCT: DIGITAL CRIMP HEIGHT CALIPER (CODE 1165-150A)

- Measure the height of crimp contact
- Resolution 0.001mm/0.00005"
- IP65 dust/waterproof
- Button function: on/off, set, mm/inch, data transmit
- Data output
- Automatic power off
- Ratchet stop
- Supplied with setting standards (except 0-25mm/0-1")
- Optional accessory: data output cable (code 7315-31 page 4, 7302-31 page 12)



3566-25BA

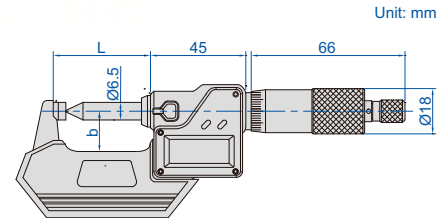

Code	Range	Type	Accuracy	L	b
3566-25BA	0-25mm/0-1"	B	±4µm	34.5	25
3566-25CA	0-25mm/0-1"	C	±4µm	34.5	25
3566-50CA	25-50mm/0-1"	C	±4µm	59.5	32
3566-75CA	50-75mm/0-1"	C	±5µm	84.5	44.5
3566-100CA	75-100mm/0-1"	C	±5µm	109.5	57
3566-25DA	0-25mm/0-1"	D	±4µm	34.5	25

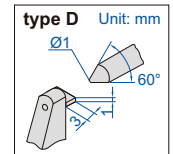
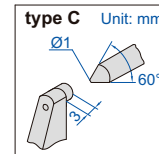
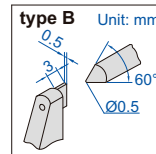

ATTENTION: SETTING STANDARDS ARE NOT INCLUDED

INSPECTION CERTIFICATE

SPLINE MICROMETERS

←INSIZE→ PLUS
MADE IN EUROPE



3658-25

Code	Range	Accuracy	L	b
3658-25*	0-25mm	4µm	62	34
3658-50*	25-50mm	4µm	87	46
3658-75*	50-75mm	5µm	112	60
3658-100*	75-100mm	5µm	139	72
3658-125*	100-125mm	6µm	164	85
3658-150*	125-150mm	6µm	190	97
3658-175*	150-175mm	7µm	215	110
3658-200*	175-200mm	7µm	240	122
3658-225*	200-225mm	8µm	264	135
3658-250*	225-250mm	8µm	290	148

*Supplied with manufacturer inspection certificate

- Meet DIN863-3
- Measure splined shafts, slots and keyways
- Graduation 0.01mm
- Ratchet stop
- Carbide measuring faces
- Optional accessory: setting standards (code 7386)

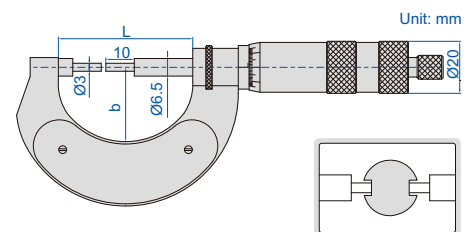

SPLINE MICROMETERS

- Meet DIN863-3
- Measure splined shafts, slots and keyways
- Graduation 0.01mm
- Ratchet stop
- Carbide measuring faces
- Supplied with setting standards (except 0-25mm)

6



(mm)

3233-25BA

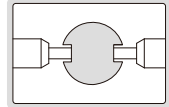

Code	Range	Type	Accuracy	L	b
3233-25A	0-25mm	A	4µm	57	32
3233-50A	25-50mm	A	4µm	82	44.5
3233-75A	50-75mm	A	5µm	107	57
3233-100A	75-100mm	A	5µm	132.6	69.5
3233-125A	100-125mm	A	6µm	158	82
3233-150A	125-150mm	A	6µm	183.4	94.5
3233-175A	150-175mm	A	7µm	208.8	107
3233-25BA	0-25mm	B	4µm	57	32
3233-50BA	25-50mm	B	4µm	82	44.5
3233-75BA	50-75mm	B	5µm	107	57
3233-100BA	75-100mm	B	5µm	132.6	69.5
3233-125BA	100-125mm	B	6µm	158	82
3233-150BA	125-150mm	B	6µm	183.4	94.5
3233-175BA	150-175mm	B	7µm	208.8	107

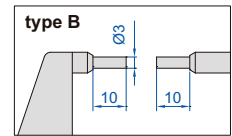
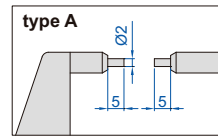
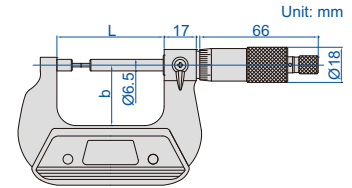

DIGITAL SPLINE MICROMETERS

IP65
WATERPROOF

DATA
OUTPUT

- Measure splined shafts, slots and keyways
- Resolution 0.001mm/0.00005"
- IP65 dust/waterproof
- Button function: on/off, set, mm/inch, data transmit
- Data output
- Automatic power off
- Ratchet stop
- Carbide measuring faces
- Supplied with setting standards (except 0-25mm/0-1")
- Optional accessory: data output cable (code 7315-31 page 4, 7302-31 page 12)



3533-25BA

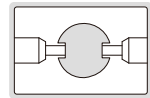

Code	Range	Type	Accuracy	L	b
3533-25A	0-25mm/0-1"	A	±4µm	57	32
3533-50A	25-50mm/1-2"	A	±4µm	82	44.5
3533-75A	50-75mm/2-3"	A	±5µm	107	57
3533-100A	75-100mm/3-4"	A	±5µm	132.6	69.5
3533-125A	100-125mm/4-5"	A	±6µm	158	82
3533-150A	125-150mm/5-6"	A	±6µm	183.4	94.5
3533-175A	150-175mm/6-7"	A	±7µm	208.8	107
3533-25BA	0-25mm/0-1"	B	±4µm	57	32
3533-50BA	25-50mm/1-2"	B	±4µm	82	44.5
3533-75BA	50-75mm/2-3"	B	±5µm	107	57
3533-100BA	75-100mm/3-4"	B	±5µm	132.6	69.5
3533-125BA	100-125mm/4-5"	B	±6µm	158	82
3533-150BA	125-150mm/5-6"	B	±6µm	183.4	94.5
3533-175BA	150-175mm/6-7"	B	±7µm	208.8	107

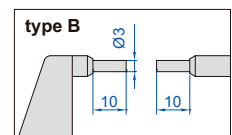
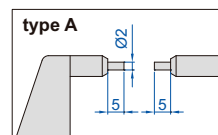
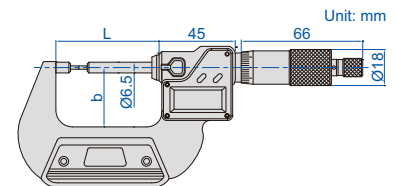



HIGH PRECISION DIGITAL SPLINE MICROMETERS/SNAP GAGES

ONE TURN OF SLEEVE MAKES 5MM SPINDLE FEED, PRESS THE FORK, THE SPINDLE RETRACTS 3MM

MEASUREMENT ACCURACY IS NOT AFFECTED BY THE USE OF SLEEVE

NON-ROTATING SPINDLE

ABSOLUTE ENCODER, THE ORIGINAL DATA REMAINS AFTER POWER OFF

IP65 WATERPROOF

ATTENTION: RECHARGEABLE BATTERY, FOR 24 HOURS CONTINUOUS WORKING

DATA OUTPUT

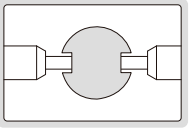

3356-25

- Measure splined shafts, slots and keyways
- Absolute encoder, the original data remains after power off
- Adjustable resolution: 0.0002mm/0.00001"
 - 0.001mm/0.00005"
 - 0.01mm/0.0005"
- One turn of sleeve makes 5mm spindle feed
- Measurement accuracy is not affected by the use of sleeve
- Press the fork, the spindle retracts 3mm
- Linear ball bearings for ten million times use
- Carbide spindle and anvil
- Measuring force 7-10N
 - Customizable measuring force range 2-12N
 - Attention: small measuring force will reduce the dustproof and waterproof level
- Button function: data output, tolerance, data preset, data hold, measuring direction change, max./min./TIR, power off time, on/off, zero, mm/inch, adjust resolution
- Supplied with gage blocks for zero setting (except 0-25mm/0-1")
- Power: rechargeable battery, for 24 hours continuous working

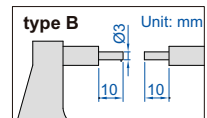
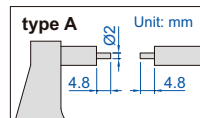
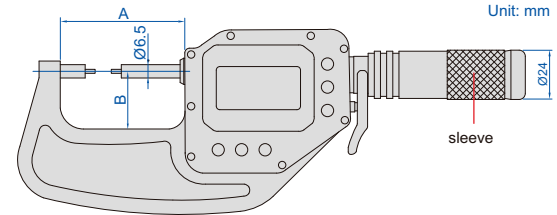

With data interface

Optional accessory:
 wireless transmitter, code 7315-3350 page 6
 data output cable (keyboard format), code 7302-3350 page 13

Code	Range	Accuracy	Type	Repeatability	A	B
3356-25 *	0-25mm/0-1"	2µm	A	1µm	63mm	25mm
3356-50 *	25-50mm/1-2"	2µm	A	1µm	88mm	42mm
3356-75 *	50-75mm/2-3"	2µm	A	1µm	113mm	56mm
3356-25B *	0-25mm/0-1"	2µm	B	1µm	63mm	25mm
3356-50B *	25-50mm/1-2"	2µm	B	1µm	88mm	42mm
3356-75B *	50-75mm/2-3"	2µm	B	1µm	113mm	56mm

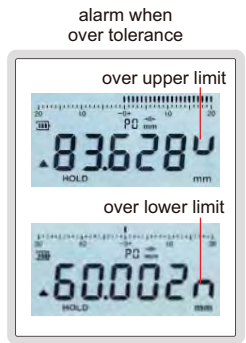

Built-in wireless

Optional accessory:
 wireless receiver (keyboard format, connect up to 15 digital indicators), code 2134-R1
 wireless receiver (serial port format, connect up to 15 digital indicators), code 2134-R2

Code	Range	Accuracy	Type	Repeatability	A	B
3356-25WL *	0-25mm/0-1"	2µm	A	1µm	63mm	25mm
3356-50WL *	25-50mm/1-2"	2µm	A	1µm	88mm	42mm
3356-75WL *	50-75mm/2-3"	2µm	A	1µm	113mm	56mm
3356-25BWL *	0-25mm/0-1"	2µm	B	1µm	63mm	25mm
3356-50BWL *	25-50mm/1-2"	2µm	B	1µm	88mm	42mm
3356-75BWL *	50-75mm/2-3"	2µm	B	1µm	113mm	56mm



* Supplied with manufacturer inspection certificate

CYLINDRICAL ANVIL TUBE MICROMETERS

6

- Measure wall thickness of tubes
- Graduation 0.01mm
- Ratchet stop
- Carbide spindle tip
- Supplied with setting standards (except 0-25mm)



3261-25A

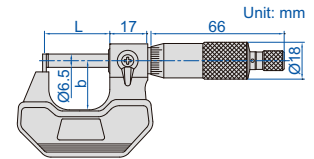
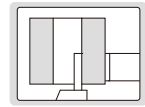

(mm)

Code	Range	Type	Accuracy	L	b
3261-25A	0-25mm	A	6µm	36	25
3261-50A	25-50mm	A	6µm	61	32
3261-25BA	0-25mm	B	6µm	36	25
3261-50BA	25-50mm	B	6µm	61	32
3261-25CA	0-25mm	C	6µm	36	25
3261-50CA	25-50mm	C	6µm	61	32
3261-25DA	0-25mm	D	6µm	36	25
3261-50DA	25-50mm	D	6µm	61	32
3261-25EA	0-25mm	E	6µm	36	25
3261-50EA	25-50mm	E	6µm	61	32
3261-25FA	0-25mm	F	6µm	36	25
3261-50FA	25-50mm	F	6µm	61	32

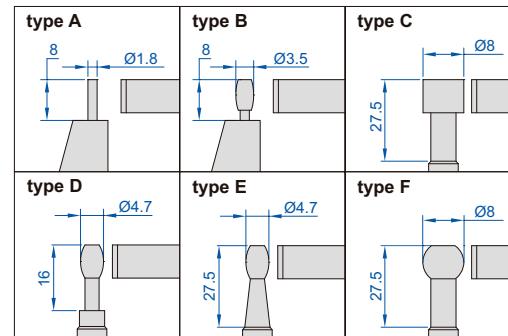

DIGITAL CYLINDRICAL ANVIL TUBE MICROMETERS

IP65
WATERPROOF

DATA
OUTPUT

- Measure wall thickness of tubes
- Resolution 0.001mm/0.00005"
- IP65 dust/waterproof
- Button function: on/off, set, mm/inch, data transmit
- Data output
- Automatic power off
- Ratchet stop
- Carbide spindle tip
- Supplied with setting standards (except 0-25mm/0-1")
- Optional accessory: data output cable (code 7315-31 page 4, 7302-31 page 12)



3561-25A

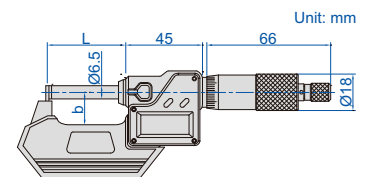
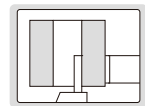

(mm)

Code	Range	Type	Accuracy	L	b
3561-25A	0-25mm/0-1"	A	±6µm	36	25
3561-50A	25-50mm/1-2"	A	±6µm	61	32
3561-25BA	0-25mm/0-1"	B	±6µm	36	25
3561-50BA	25-50mm/1-2"	B	±6µm	61	32
3561-25CA	0-25mm/0-1"	C	±6µm	36	25
3561-50CA	25-50mm/1-2"	C	±6µm	61	32
3561-25DA	0-25mm/0-1"	D	±6µm	36	25
3561-50DA	25-50mm/1-2"	D	±6µm	61	32
3561-25EA	0-25mm/0-1"	E	±6µm	36	25
3561-50EA	25-50mm/1-2"	E	±6µm	61	32
3561-25FA	0-25mm/0-1"	F	±6µm	36	25
3561-50FA	25-50mm/1-2"	F	±6µm	61	32

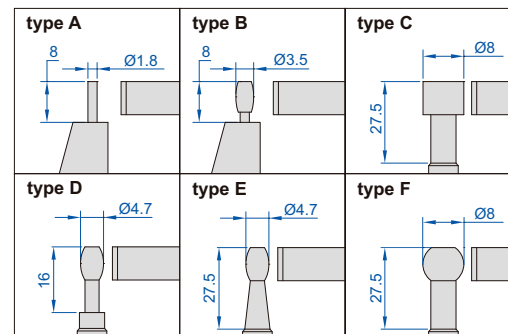

SPHERICAL ANVIL TUBE MICROMETERS

- Meet DIN863-3
- Measure wall thickness of tubes
- Graduation 0.01mm
- Ratchet stop
- Carbide measuring faces
- Supplied with setting standards (except 0-25mm)



3260-25A

Code	Range	Type	Accuracy	L	b
3260-25A	0-25mm	A	4µm	32	24
3260-50A	25-50mm	A	4µm	57	32
3260-75A	50-75mm	A	5µm	82	44.5
3260-100A	75-100mm	A	5µm	107	57
3260-25SA	0-25mm	B	4µm	32	24
3260-50SA	25-50mm	B	4µm	57	32
3260-75SA	50-75mm	B	5µm	82	44.5
3260-100SA	75-100mm	B	5µm	107	57

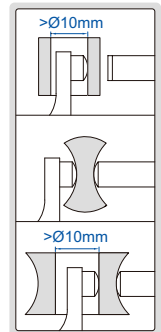
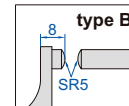
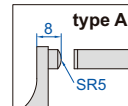
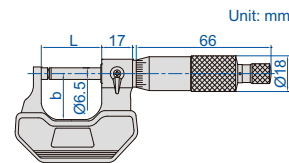

IP65
WATERPROOF

DATA
OUTPUT

DIGITAL SPHERICAL ANVIL TUBE MICROMETERS

- Measure wall thickness of tubes
- Resolution 0.001mm/0.00005"
- IP65 dust/waterproof
- Button function: on/off, set, mm/inch, data transmit
- Data output
- Automatic power off
- Ratchet stop
- Carbide measuring faces
- Supplied with setting standards (except 0-25mm/0-1")
- Optional accessory: data output cable (code 7315-31 page 4, 7302-31 page 12)



3560-25A

Code	Range	Type	Accuracy	L	b
3560-25A	0-25mm/0-1"	A	±4µm	32	24
3560-50A	25-50mm/1-2"	A	±4µm	57	32
3560-75A	50-75mm/2-3"	A	±5µm	82	44.5
3560-100A	75-100mm/3-4"	A	±5µm	107	57
3560-25SA	0-25mm/0-1"	B	±4µm	32	24
3560-50SA	25-50mm/1-2"	B	±4µm	57	32
3560-75SA	50-75mm/2-3"	B	±5µm	82	44.5
3560-100SA	75-100mm/3-4"	B	±5µm	107	57

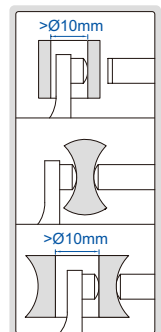
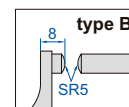
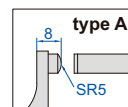
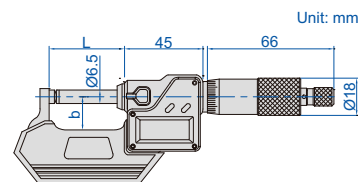

HIGH PRECISION DIGITAL SPHERICAL ANVIL TUBE MICROMETERS/SNAP GAGES

IP65
WATERPROOF

NON-ROTATING
SPINDLE

ABSOLUTE ENCODER, THE ORIGINAL
DATA REMAINS AFTER POWER OFF

ONE TURN OF SLEEVE MAKES 5MM SPINDLE FEED,
PRESS THE FORK, THE SPINDLE RETRACTS 3MM

MEASUREMENT ACCURACY IS NOT
AFFECTED BY THE USE OF SLEEVE

INSPECTION
CERTIFICATE

ATTENTION: RECHARGEABLE BATTERY,
FOR 24 HOURS CONTINUOUS WORKING

DATA
OUTPUT

6

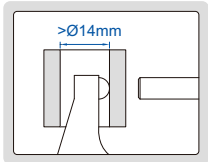

3355-25

- Measure wall thickness of tubes
- Absolute encoder, the original data remains after power off
- Adjustable resolution: 0.0002mm/0.00001"
0.001mm/0.00005"
0.01mm/0.0005"
- One turn of sleeve makes 5mm spindle feed
- Measurement accuracy is not affected by the use of sleeve
- Press the fork, the spindle retracts 3mm
- Linear ball bearings for ten million times use
- Carbide spindle and anvil
- Measuring force 7-10N
Customizable measuring force range 2-12N
Attention: small measuring force will reduce the dustproof and waterproof level
- Button function: data output, tolerance, data preset, data hold, measuring direction change, max./min./TIR, power off time, on/off, zero, mm/inch, adjust resolution
- Supplied with gage blocks for zero setting (except 0-25mm/0-1")
- Power: rechargeable battery, for 24 hours continuous working

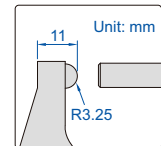
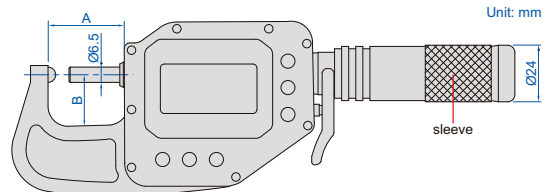

With data interface

Optional accessory:
wireless transmitter, code **7315-3350** page 6
data output cable (keyboard format), code **7302-3350** page 13

Code	Range	Accuracy	Repeatability	A	B
3355-25 *	0-25mm/0-1"	2µm	1µm	38mm	24mm
3355-50 *	25-50mm/1-2"	2µm	1µm	63mm	25mm
3355-75 *	50-75mm/2-3"	2µm	1µm	88mm	42mm
3355-100 *	75-100mm/3-3.95"	2µm	1µm	113mm	56mm

Built-in wireless

Optional accessory:
wireless receiver (keyboard format, connect up to 15 digital indicators), code **2134-R1**
wireless receiver (serial port format, connect up to 15 digital indicators), code **2134-R2**

Code	Range	Accuracy	Repeatability	A	B
3355-25WL *	0-25mm/0-1"	2µm	1µm	38mm	24mm
3355-50WL *	25-50mm/1-2"	2µm	1µm	63mm	25mm
3355-75WL *	50-75mm/2-3"	2µm	1µm	88mm	42mm
3355-100WL *	75-100mm/3-3.95"	2µm	1µm	113mm	56mm

*Supplied with manufacturer inspection certificate

alarm when
over tolerance

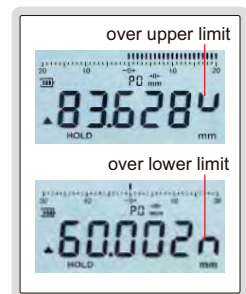

wireless receiver
2134-R1, 2134-R2 (optional)



RELATIVE PRODUCT: DIGITAL DISK BRAKE AND PAD CALIPER
DIGITAL DRUM BRAKE CALIPER (CODE 1162-125A, 1167-150A, 1168-300A)

DISK BRAKE MICROMETERS

- Measure thickness of disk brakes
- Graduation 0.01mm
- Ratchet stop
- Carbide measuring faces
- Supplied with setting standards

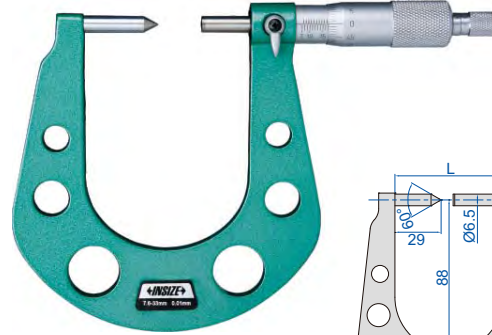

3288-33A

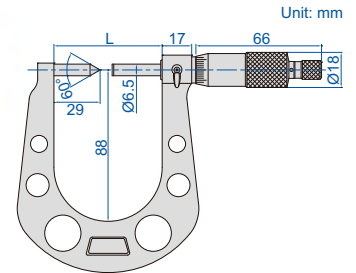

Code	Range	Accuracy	L
3288-33A	7.6-33mm	5µm	64.5mm
3288-50A	25-50mm	5µm	82mm

RELATIVE PRODUCT: DIGITAL DISK BRAKE AND PAD CALIPER
DIGITAL DRUM BRAKE CALIPER (CODE 1162-125A, 1167-150A, 1168-300A)

DIGITAL DISK BRAKE MICROMETERS

- Measure thickness of disk brakes
- Resolution 0.001mm/0.00005"
- IP65 dust/waterproof
- Button function: on/off, set, mm/inch, data transmit
- Data output
- Automatic power off
- Ratchet stop
- Carbide measuring faces
- Supplied with setting standards
- Optional accessory: data output cable (code 7315-31 page 4, 7302-31 page 12)



3588-33A

IP65
WATERPROOF

DATA
OUTPUT

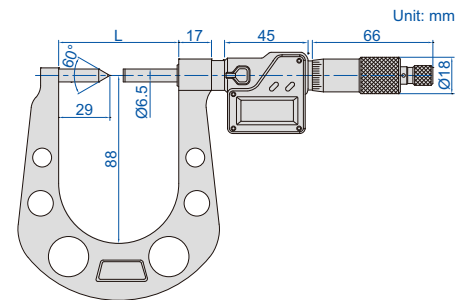

Code	Range	Accuracy	L
3588-33A	7.6-33mm/0.3-1.3"	±5µm	64.5mm
3588-50A	25-50mm/1-2"	±5µm	82mm

ATTENTION: SETTING STANDARDS ARE NOT INCLUDED

SHEET METAL MICROMETERS

INSIZE PLUS
MADE IN EUROPE

- Deep frame suitable for sheet metal, paper and plastic
- Graduation 0.01mm
- Ratchet stop
- Carbide measuring faces
- Optional accessory: setting standards (code 7386)



3653-252A

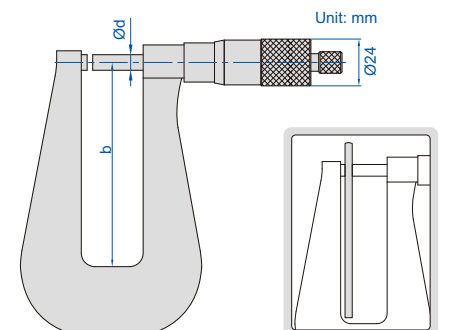

Code	Range	Accuracy	(mm)	
			b	Ød
3653-251A	0-25mm	4µm	50	6.5
3653-252A	0-25mm	5µm	100	8
3653-253A	0-25mm	6µm	150	6.5
3653-254A	0-25mm	8µm	250	6.5
3653-501A	25-50mm	4µm	50	8
3653-502A	0-50mm	4µm	50	8
3653-503A	0-50mm	5µm	100	8
3653-100A	50-100mm	5µm	100	8

SHEET METAL MICROMETERS

- Deep frame suitable for sheet metal, paper and plastic
- Graduation 0.01mm
- Ratchet stop
- Carbide measuring faces

6

Code	Range	Type	Accuracy	b
3239-253	0-25mm	A	7µm	155mm
3239-253F	0-25mm	B	7µm	155mm
3239-254F	0-25mm	B	10µm	310mm
3239-253S	0-25mm	C	7µm	155mm



3239-253

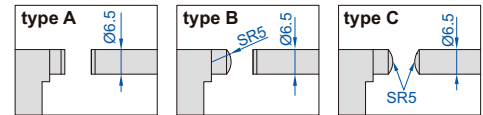
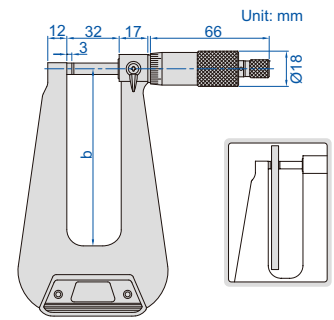

DIGITAL SHEET METAL MICROMETERS

DATA OUTPUT

IP65 WATERPROOF

- Deep frame suitable for sheet metal, paper and plastic
- Resolution 0.001mm/0.00005"
- IP65 dust/waterproof
- Button function: on/off, set, mm/inch, data transmit
- Data output
- Automatic power off
- Ratchet stop
- Carbide measuring faces
- Optional accessory: data output cable (code 7315-31 page 4, 7302-31 page 12)



3539-253A

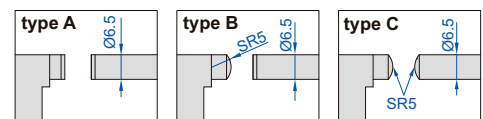
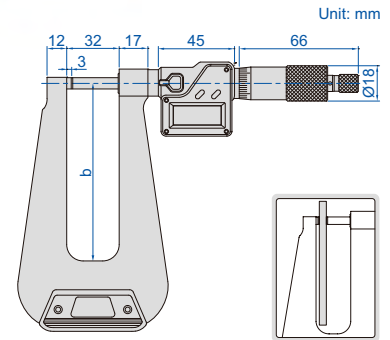

Code	Range	Type	Accuracy	b
3539-253A	0-25mm/0-1"	A	±7µm	155mm
3539-253FA	0-25mm/0-1"	B	±7µm	155mm
3539-254FA	0-25mm/0-1"	B	±10µm	310mm
3539-253SA	0-25mm/0-1"	C	±7µm	155mm

INTERCHANGEABLE ANVIL MICROMETERS

- Measure tube thickness, shoulder edge distance, rivet head height, etc.
- Supplied with flat anvil and rod anvil
- Graduation 0.01mm
- Ratchet stop
- Carbide spindle tip
- Setting standards are included (except 0-25mm)



3262-25A

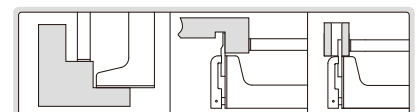
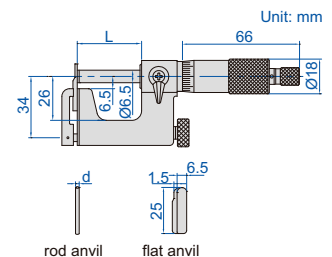

Code	Range	Accuracy	L	d
3262-25A	0-25mm	4µm	28.5mm	Ø3mm
3262-50A	25-50mm	4µm	53.5mm	Ø5mm

IP65
WATERPROOF

DATA
OUTPUT

DIGITAL INTERCHANGEABLE ANVIL MICROMETERS

- Measure tube thickness, shoulder edge distance, rivet head height, etc.
- Supplied with flat anvil and rod anvil
- Resolution 0.001mm/0.00005"
- IP65 dust/waterproof
- Button function: on/off, set, mm/inch, data transmit
- Data output
- Automatic power off
- Ratchet stop
- Carbide spindle tip
- Setting standards are included (except 0-25mm/0-1")
- Optional accessory: data output cable (code 7315-31 page 4, 7302-31 page 12)



3562-25A

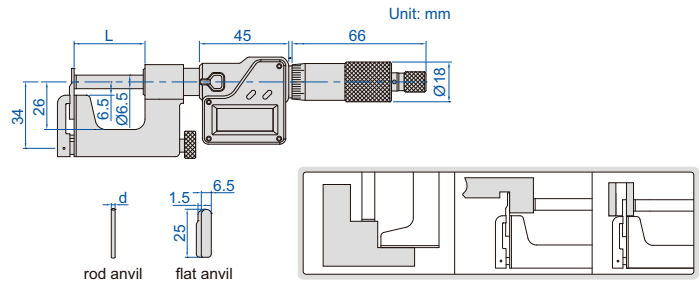

Code	Range	Accuracy	L	d
3562-25A	0-25mm/0-1"	±4µm	28.5mm	Ø3mm
3562-50A	25-50mm/1-2"	±4µm	53.5mm	Ø5mm

6

LARGE ANVIL MICROMETERS

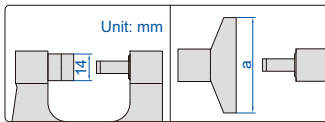

3234-25A

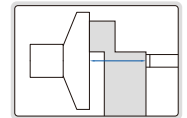

- Graduation 0.01mm
- Ratchet stop
- Supplied with setting standards (except 0-25mm)

Code	Range	Accuracy	L	a	b
3234-25A	0-25mm	4µm	42mm	50mm	26mm
3234-50A	25-50mm	4µm	67mm	60mm	38mm

DIGITAL LARGE ANVIL MICROMETERS

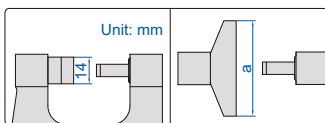

DATA
OUTPUT

IP65
WATERPROOF



3534-25A

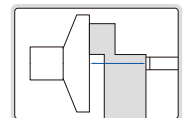

- Resolution 0.001mm/0.00005"
- IP65 dust/waterproof
- Button function: on/off, set, mm/inch, data transmit
- Data output
- Automatic power off
- Ratchet stop
- Supplied with setting standards (except 0-25mm/0-1")
- Optional accessory: data output cable (code 7315-31 page 4, 7302-31 page 12)

Code	Range	Accuracy	L	a	b
3534-25A	0-25mm/0-1"	±4µm	42mm	50mm	26mm
3534-50A	25-50mm/1-2"	±4µm	67mm	60mm	38mm

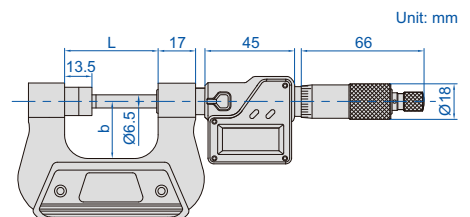

V-ANVIL MICROMETERS

6



3290-153A

- Measure the diameter of parts or cutting tools with odd grooves, such as taps, reamers and end mills
- Graduation 0.01mm
- Ratchet stop
- Carbide measuring faces
- Supplied with setting standards

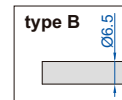
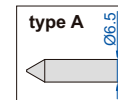
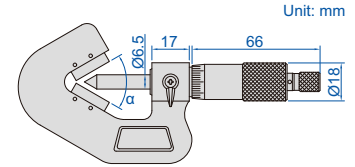

Code	Range	Flutes	Accuracy	α	Type
3290-153A	1-15mm	3	4 μ m	60°	A
3290-203A	5-20mm	3	4 μ m	60°	B
3290-353A	20-35mm	3	5 μ m	60°	B
3290-503A	35-50mm	3	5 μ m	60°	B
3290-653A	50-65mm	3	6 μ m	60°	B
3290-803A	65-80mm	3	6 μ m	60°	B
3290-953A	80-95mm	3	7 μ m	60°	B
3290-255A	5-25mm	5	4 μ m	108°	B

Code	Range	Flutes	Accuracy	α	Type
3290-455A	25-45mm	5	5 μ m	108°	B
3290-655A	45-65mm	5	6 μ m	108°	B
3290-855A	65-85mm	5	7 μ m	108°	B
3290-1055A	85-105mm	5	8 μ m	108°	B
3290-257A	5-25mm	7	4 μ m	128°34'17"	B
3290-457A	25-45mm	7	5 μ m	128°34'17"	B
3290-657A	45-65mm	7	6 μ m	128°34'17"	B
3290-857A	65-85mm	7	7 μ m	128°34'17"	B

DIGITAL V-ANVIL MICROMETERS

IP65
WATERPROOF

DATA
OUTPUT



3590-153A

- Measure the diameter of parts or cutting tools with odd grooves, such as taps, reamers and end mills
- Resolution 0.001mm/0.00005"
- IP65 dust/waterproof
- Button function: on/off, set, mm/inch, data transmit
- Data output
- Automatic power off
- Ratchet stop
- Carbide measuring faces
- Supplied with setting standards
- Optional accessory: data output cable (code 7315-31 page 4, 7302-31 page 12)

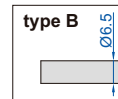
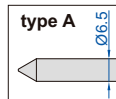
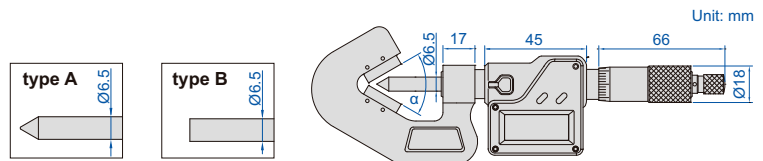

Code	Range	Flutes	Accuracy	α	Type
3590-153A	1-15mm/0.04-0.6"	3	±4 μ m	60°	A
3590-203A	5-20mm/0.2-0.8"	3	±4 μ m	60°	B
3590-353A	20-35mm/0.8-1.4"	3	±5 μ m	60°	B
3590-503A	35-50mm/1.4-2.0"	3	±5 μ m	60°	B
3590-653A	50-65mm/2.0-2.6"	3	±6 μ m	60°	B
3590-803A	65-80mm/2.6-3.2"	3	±6 μ m	60°	B
3590-953A	80-95mm/3.2-3.6"	3	±6 μ m	60°	B
3590-255A	5-25mm/0.2-1.0"	5	±4 μ m	108°	B

Code	Range	Flutes	Accuracy	α	Type
3590-455A	25-45mm/1.0-1.8"	5	±5 μ m	108°	B
3590-655A	45-65mm/1.8-2.6"	5	±6 μ m	108°	B
3590-855A	65-85mm/2.6-3.4"	5	±6 μ m	108°	B
3590-1055A	85-105mm/3.4-4.2"	5	±6 μ m	108°	B
3590-257A	5-25mm/0.2-1.0"	7	±4 μ m	128°34'17"	B
3590-457A	25-45mm/1.0-1.8"	7	±4 μ m	128°34'17"	B
3590-657A	45-65mm/1.8-2.6"	7	±5 μ m	128°34'17"	B
3590-857A	65-85mm/2.6-3.4"	7	±5 μ m	128°34'17"	B

NON-ROTATING SPINDLE UNIVERSAL MICROMETERS

NON-ROTATING SPINDLE

Anvil/spindle tip (included) Unit: mm

Flat		
Spherical		
Spline		
Disk		
Blade		
Knife-edge		
Point		



3280-25A

- Meet DIN863-3
- Graduation 0.01mm
- Non-rotating spindle
- Ratchet stop
- Supplied with 7 pairs of anvil/spindle tip
- Setting standards are included (except 0-25mm)
- Optional accessory: 55° anvil/spindle tip (code 3280-SP1 and 3280-SP2)

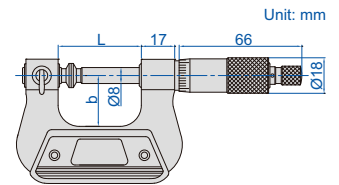

Unit: mm

Code	Range	Accuracy	L	b
3280-25A	0-25mm	4µm	42mm	26mm
3280-50A	25-50mm	4µm	67mm	38mm
3280-75A	50-75mm	5µm	92mm	50mm
3280-100A	75-100mm	5µm	118mm	62mm
3280-125A	100-125mm	6µm	143mm	70mm
3280-150A	125-150mm	6µm	168mm	82mm
3280-175A	150-175mm	7µm	192mm	95mm
3280-200A	175-200mm	7µm	217mm	107mm

55° anvil/spindle tip (optional) Unit: mm

Code 3280-SP1 Knife-edge		
Code 3280-SP2 Point		

DIGITAL UNIVERSAL MICROMETERS

DATA OUTPUT

NON-ROTATING SPINDLE

Anvil/spindle tip (included) Unit: mm

Flat		
Spherical		
Spline		
Disk		
Blade		
Knife-edge		
Point		



3580-25A

- Resolution 0.001mm/0.00005"
- Non-rotating spindle
- Button function: on/off, set, mm/inch, data transmit
- Data output
- Automatic power off
- Ratchet stop
- Supplied with 7 pairs of anvil/spindle tip
- Setting standards are included (except 0-25mm/0-1")
- Optional accessory: 55° anvil/spindle tip code 3280-SP1 and 3280-SP2, data output cable (code 7315-31 page 4, 7302-31 page 12)

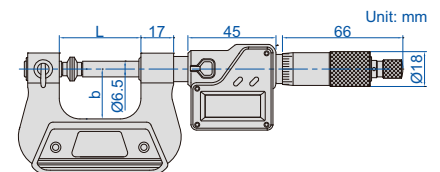

Unit: mm

Code	Range	Accuracy	L	b
3580-25A	0-25mm/0-1"	±4µm	42	26
3580-50A	25-50mm/1-2"	±4µm	67	38
3580-75A	50-75mm/2-3"	±5µm	92	50
3580-100A	75-100mm/3-4"	±5µm	118	62
3580-125A	100-125mm/4-5"	±6µm	143	70
3580-150A	125-150mm/5-6"	±6µm	168	82
3580-175A	150-175mm/6-7"	±7µm	192	95
3580-200A	175-200mm/7-8"	±7µm	217	107

(mm)

CALIPER TYPE MICROMETERS

6

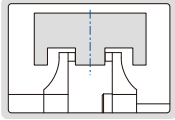

3238-25

- Graduation 0.01mm
- Non-rotating spindle
- Ratchet stop
- Carbide measuring faces
- Supplied with setting standards (except 0-25mm)

Code	Range	Accuracy	L
3238-25	0-25mm	10 μ m	56mm
3238-50	25-50mm	10 μ m	81mm
3238-75	50-75mm	11 μ m	106mm
3238-100	75-100mm	11 μ m	131mm

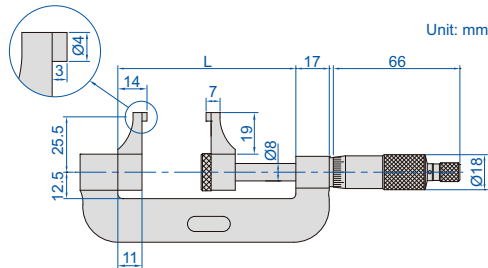

DIGITAL CALIPER TYPE MICROMETERS

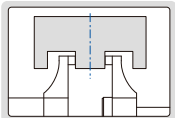

3538-25

- Resolution: 0.001mm/0.00005"
- Non-rotating spindle
- Buttons: on/off, data set, mm/in, ABS/INC
- Data output
- Automatic power off
- Ratchet friction thimble
- Carbide measuring faces
- Supplied with setting standards (except 0-25mm/0-1")

Code	Range	Accuracy	L
3538-25	0-25mm/0-1"	\pm 10 μ m	56mm
3538-50	25-50mm/1-2"	\pm 10 μ m	81mm
3538-75	50-75mm/2-3"	\pm 11 μ m	106mm
3538-100	75-100mm/3-4"	\pm 11 μ m	131mm

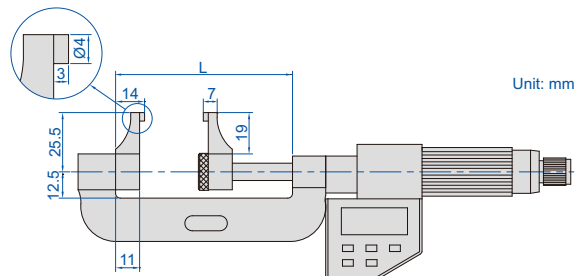

NON-ROTATING SPINDLE

JAW TYPE MICROMETERS

- Graduation 0.01mm
- Non-rotating spindle
- Ratchet stop
- Supplied with setting standards (except 0-25mm)



3283-25A

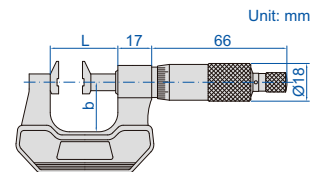

Code	Range	Accuracy	L	a	b	c	R	D
3283-25A	0-25mm	4µm	34	6	24	5	10	8
3283-50A	25-50mm	4µm	59	6	32	5	10	8
3283-75A	50-75mm	5µm	85	6	45	5	10	8
3283-100A	75-100mm	5µm	110	6	57	5	10	8
3283-125A	100-125mm	6µm	138	9	70	8	15	12
3283-150A	125-150mm	6µm	163	9	82	8	15	12
3283-175A	150-175mm	7µm	188	9	95	8	15	12
3283-200A	175-200mm	7µm	214	9	107	8	15	12

(mm)

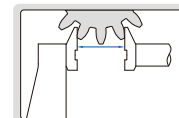
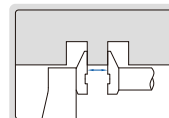
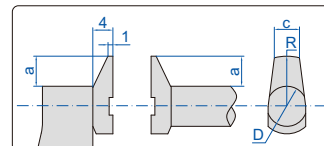

DATA OUTPUT

NON-ROTATING SPINDLE

DIGITAL JAW TYPE MICROMETERS



3583-25A

- Resolution 0.001mm/0.00005"
- Non-rotating spindle
- Button function: on/off, set, mm/inch, data transmit
- Data output
- Automatic power off
- Ratchet stop
- Supplied with setting standards (except 0-25mm/0-1")
- Optional accessory: data output cable (code 7315-31 page 4, 7302-31 page 12)

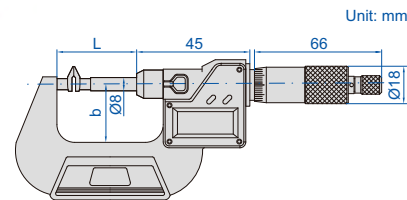

Code	Range	Accuracy	L	a	b	c	R	D
3583-25A	0-25mm/0-1"	±4µm	43	6.5	32	5	10	8
3583-50A	25-50mm/1-2"	±4µm	85	6.5	44.5	5	10	8
3583-75A	50-75mm/2-3"	±5µm	110	6.5	57	5	10	8
3583-100A	75-100mm/3-4"	±5µm	135	6.5	70	5	10	8
3583-125A	100-125mm/4-5"	±6µm	160	11.5	86	8	15	12
3583-150A	125-150mm/5-6"	±6µm	186	11.5	94.5	8	15	12
3583-175A	150-175mm/6-7"	±7µm	211	11.5	107	8	15	12
3583-200A	175-200mm/7-8"	±7µm	236	11.5	120	8	15	12

(mm)

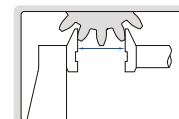
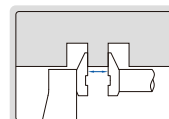
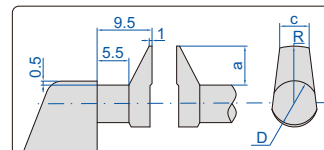

DISK MICROMETERS

INSIZE PLUS
MADE IN EUROPE

- Graduation: 0.01mm
- Ratchet stop
- One turn of sleeve makes 0.5mm spindle feed
- Optional accessory: setting standards (code 7386)

ATTENTION: SETTING
STANDARDS ARE NOT INCLUDED



3676-25

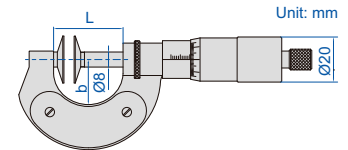
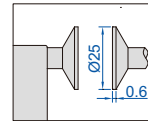
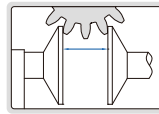

6

(mm)

Code	Range	Accuracy	L	b
3676-25	0-25mm	4µm	37	24
3676-50	25-50mm	4µm	62	34
3676-75	50-75mm	5µm	87	46
3676-100	75-100mm	5µm	112	60
3676-125	100-125mm	6µm	139	72
3676-150	125-150mm	6µm	164	85
3676-175	150-175mm	7µm	190	97
3676-200	175-200mm	7µm	215	110
3676-225	200-225mm	8µm	240	122
3676-250	225-250mm	8µm	264	135
3676-275	250-275mm	9µm	290	148
3676-300	275-300mm	9µm	315	160

LARGE RANGE DISK MICROMETERS

INSIZE PLUS
MADE IN EUROPE

ATTENTION: SETTING
STANDARDS ARE NOT INCLUDED

LIGHT
WEIGHT

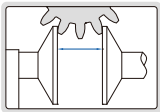

- Graduation: 0.01mm
- Ratchet stop
- Quick measurement, one turn of sleeve makes 1mm spindle feed
- Light weight
- Optional accessory: setting standards (code 7386)



3677-350

(mm)

Code	Range	Accuracy	L	b	Weight
3677-350	300-350mm	8µm	370	190	1.65kg
3677-400	350-400mm	8µm	430	220	1.95kg
3677-450	400-450mm	9µm	475	250	2.30kg
3677-500	450-500mm	9µm	530	273	2.45kg
3677-550	500-550mm	10µm	570	291	2.55kg
3677-600	550-600mm	10µm	630	323	3.15kg
3677-650	600-650mm	10µm	675	351	3.45kg
3677-700	650-700mm	10µm	730	378	3.85kg
3677-750	700-750mm	10µm	785	401	4.05kg
3677-800	750-800mm	10µm	830	423	4.25kg
3677-850	800-850mm	11µm	885	440	4.45kg
3677-900	850-900mm	11µm	930	473	5.05kg
3677-950	900-950mm	11µm	980	503	5.95kg
3677-1000	950-1000mm	11µm	1030	520	6.25kg

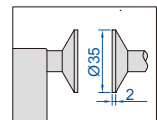
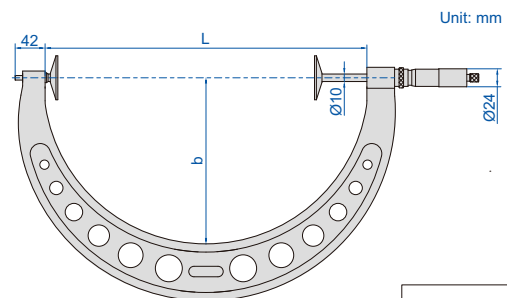

DISK MICROMETERS

- Measure root tangent length of gear
- Graduation 0.01mm
- Ratchet stop
- Supplied with setting standards

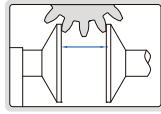

3282-25

Code	Range	Accuracy	Parallelism	L	b	c
3282-25	0-25mm	4µm	5µm	34	24	3.3
3282-50	25-50mm	4µm	5µm	59	32	3.3
3282-75	50-75mm	5µm	5µm	85	45	3.3
3282-100	75-100mm	5µm	5µm	110	57	3.3

(mm)

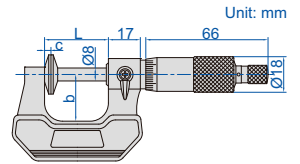
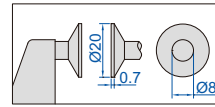

6

NON-ROTATING SPINDLE

NON-ROTATING SPINDLE DISK MICROMETERS

- Measure root tangent length of gear
- Graduation 0.01mm
- Non-rotating spindle
- Ratchet stop
- Supplied with setting standards

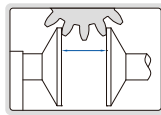

3294-25

Code	Range	Accuracy	Parallelism	L	b
3294-25	0-25mm	4µm	5µm	34	24
3294-50	25-50mm	4µm	5µm	59	32
3294-75	50-75mm	5µm	5µm	85	45
3294-100	75-100mm	5µm	5µm	110	57

(mm)

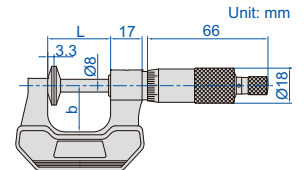
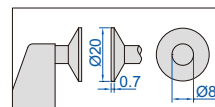

DATA OUTPUT

NON-ROTATING SPINDLE

DIGITAL NON-ROTATING SPINDLE DISK MICROMETERS

- Measure root tangent length of gear
- Resolution 0.001mm/0.00005"
- Non-rotating spindle
- Button function: on/off, set, mm/inch, data transmit
- Data output
- Automatic power off
- Ratchet stop
- Supplied with setting standards
- Optional accessory: data output cable (code 7315-31 page 4, 7302-31 page 12)

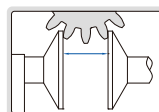

3594-25A

Code	Range	Accuracy	Parallelism	L	b
3594-25A	0-25mm/0-1"	±4µm	5µm	43mm	32mm
3594-50A	25-50mm/1-2"	±4µm	5µm	68mm	44.5mm
3594-75A	50-75mm/2-3"	±5µm	5µm	93mm	57mm
3594-100A	75-100mm/3-4"	±5µm	5µm	118.5mm	70mm

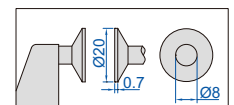
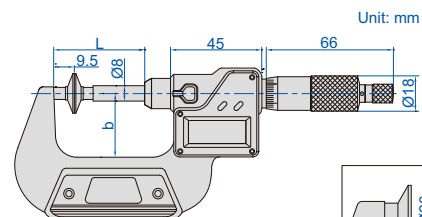

HIGH PRECISION DIGITAL DISK MICROMETERS/SNAP GAGES

DATA OUTPUT

NON-ROTATING SPINDLE

ONE TURN OF SLEEVE MAKES 5MM SPINDLE FEED, PRESS THE FORK, THE SPINDLE RETRACTS 3MM

ABSOLUTE ENCODER, THE ORIGINAL DATA REMAINS AFTER POWER OFF

MEASUREMENT ACCURACY IS NOT AFFECTED BY THE USE OF SLEEVE

ATTENTION: RECHARGEABLE BATTERY, FOR 24 HOURS CONTINUOUS WORKING

IP65 WATERPROOF



6



3353-25

- Measure root tangent length of gear
- Absolute encoder, the original data remains after power off
- Adjustable resolution: 0.0002mm/0.00001"
 - 0.001mm/0.00005"
 - 0.01mm/0.0005"
- One turn of sleeve makes 5mm spindle feed
- Measurement accuracy is not affected by the use of sleeve
- Press the fork, the spindle retracts 3mm
- Linear ball bearings for ten million times use
- Carbide spindle and anvil
- Measuring force 7-10N
 - Customizable measuring force range 2-12N
 - Attention: small measuring force will reduce the dustproof and waterproof level
- Button function: data output, tolerance, data preset, data hold, measuring direction change, max./min./TIR, power off time, on/off, zero, mm/inch, adjust resolution
- Supplied with gage blocks for zero setting
- Power: rechargeable battery, for 24 hours continuous working

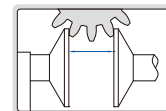
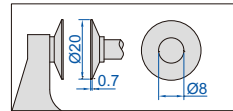
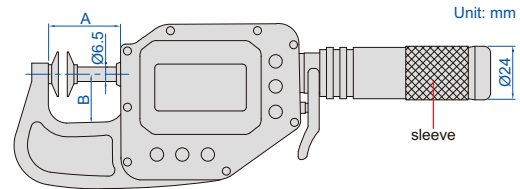

With data interface

Optional accessory:
wireless transmitter, code **7315-3350** page 6
data output cable (keyboard format), code **7302-3350** page 13

Code	Range	Accuracy	Repeatability	Parallelism	A	B
3353-25 *	0-25mm/0-1"	4µm	1µm	4µm	38mm	24mm
3353-50 *	25-50mm/1-2"	4µm	1µm	4µm	63mm	25mm
3353-75 *	50-75mm/2-3"	5µm	1µm	5µm	88mm	42mm
3353-100 *	75-100mm/3-3.95"	5µm	1µm	5µm	113mm	56mm
3353-125 *	100-125mm/4-5"	6µm	2µm	6µm	128mm	62.5mm
3353-150 *	125-150mm/5-6"	6µm	2µm	6µm	153mm	75mm

Built-in wireless

Optional accessory:
wireless receiver (keyboard format, connect up to 15 digital indicators), code **2134-R1**
wireless receiver (serial port format, connect up to 15 digital indicators), code **2134-R2**

Code	Range	Accuracy	Repeatability	Parallelism	A	B
3353-25WL *	0-25mm/0-1"	4µm	1µm	4µm	38mm	24mm
3353-50WL *	25-50mm/1-2"	4µm	1µm	4µm	63mm	25mm
3353-75WL *	50-75mm/2-3"	5µm	1µm	5µm	88mm	42mm
3353-100WL *	75-100mm/3-3.95"	5µm	1µm	5µm	113mm	56mm
3353-125WL *	100-125mm/4-5"	6µm	2µm	6µm	128mm	62.5mm
3353-150WL *	125-150mm/5-6"	6µm	2µm	6µm	153mm	75mm

* Supplied with manufacturer inspection certificate

alarm when over tolerance

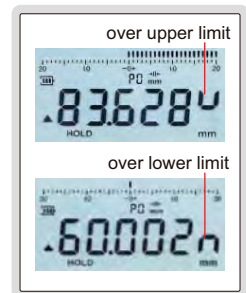

wireless receiver

2134-R1, 2134-R2 (optional)



SHEET METAL MICROMETERS

- Meet DIN863-3
- Measure thickness of sheet metal, paper, plastic and rubber parts
- Graduation 0.01mm
- Ratchet stop
- Carbide measuring faces



3263-25A

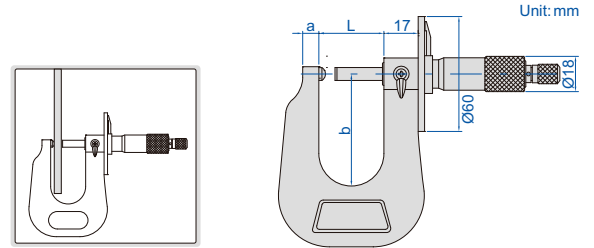

6

Code	Range	Type	Accuracy	L	a	b
3263-15A	0-15mm	A	4µm	22	8	50
3263-25A	0-25mm	A	4µm	32	8	50
3263-50A	0-50mm	A	5µm	57	12	100
3263-15B	0-15mm	B	4µm	22	8	50
3263-25B	0-25mm	B	4µm	32	8	50
3263-50B	0-50mm	B	5µm	57	12	100

(mm)

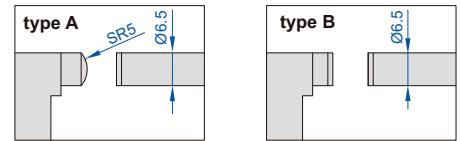

MICROMETERS FOR HOT PLATE

- Measure thickness of hot rolling sheet metal
- Carbide measuring faces
- Supplied with setting standard (except 0-15mm)



3264-15

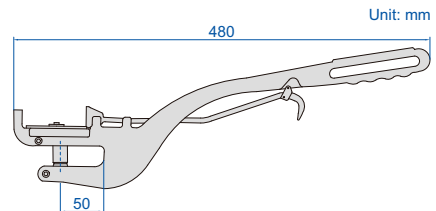

Code	Range	Graduation	Accuracy
3264-15	0-15mm	0.05mm	0.05mm
3264-30	15-30mm	0.05mm	0.05mm
3264-45	30-45mm	0.05mm	0.05mm
3264-60	45-60mm	0.05mm	0.05mm
3264-75	60-75mm	0.05mm	0.05mm
3264-90	75-90mm	0.05mm	0.05mm
3264-105	90-105mm	0.05mm	0.05mm

HUB MICROMETERS

- Meet DIN863-3
- Measure hub thickness and shoulder inside a bore
- Graduation 0.01mm
- Ratchet stop
- Carbide measuring faces
- Supplied with setting standards (except 0-25mm)



3292-25

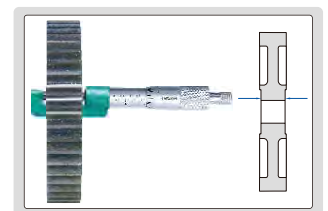
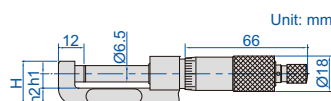

Code	Range	Accuracy	h1	h2	H
3292-25	0-25mm	4µm	6	9	18.7
3292-50	25-50mm	4µm	6.5	11	21.2
3292-75	50-75mm	5µm	6.5	11	21.2
3292-100	75-100mm	5µm	6.5	11	21.2

(mm)

WIRE MICROMETER

- Meet DIN863-3
- Measure diameter of wires and small balls
- Graduation 0.01mm
- Ratchet stop
- Carbide measuring faces

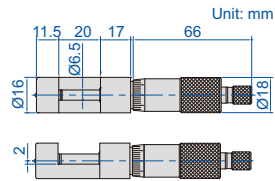

3285-10

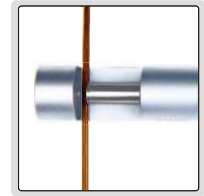

Code	Range	Accuracy
3285-10	0-10mm	4µm

6

CAN SEAM MICROMETERS



3293-131



3293-132



3293-133

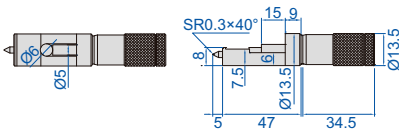

3293-131

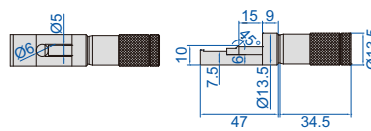

3293-132

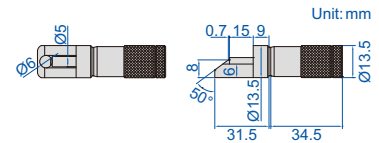

3293-133

- Measure the width, height and depth of can seams
- Graduation 0.01mm

Code	Range	Accuracy
3293-131	0-13mm	4µm
3293-132	0-13mm	4µm
3293-133	0-13mm	4µm

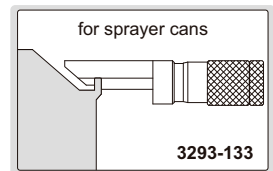
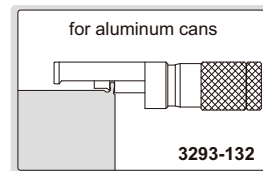
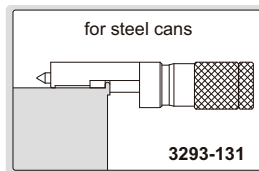

OPTICAL PARALLELS

- Check the flatness and parallelism of measuring faces of micrometer
- Flatness of A and B: 0.1µm
- Parallelism between A and B: 0.6µm



4184-41A

Code	Parallels included (b)	ØD	Applicable micrometer
4184-41A	15.62mm, 15.75mm, 15.87mm, 16.00mm	30mm	0-25mm
4184-42A	40.62mm, 40.75mm, 40.87mm, 41.00mm	30mm	25-50mm
4184-43B	65.62mm, 65.75mm, 65.87mm, 66.00mm	40mm	50-75mm
4184-44B	90.62mm, 90.75mm, 90.87mm, 91.00mm	50mm	75-100mm

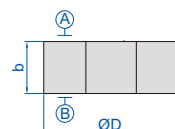

MICROMETER MEASURING FORCE DETECTOR

- For outside micrometers
0-25mm/0-1", 25-50mm/1-2",
50-75mm/2-3" and 75-100mm/3-4"

Code	Measuring force
6315	5-12N



6315

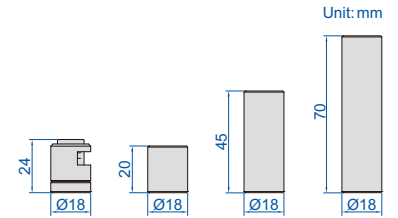

REFER TO PAGE
290-291 FOR DETAILS

MICROMETER INSPECTION GAGE BLOCK SETS



4107-10



4160-10

MICROMETER STAND



6302

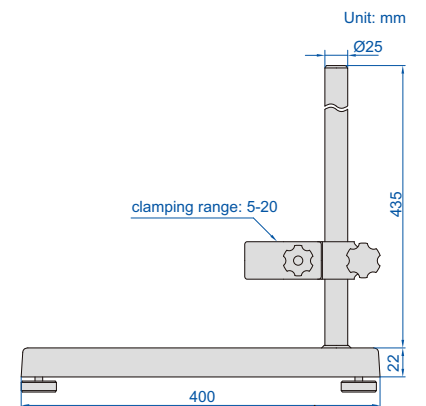

Code
6302

- Suitable for 100-300mm outside micrometers
(except 3675 series)

MICROMETER STAND

- Suitable for outside micrometers up to 100mm



6300

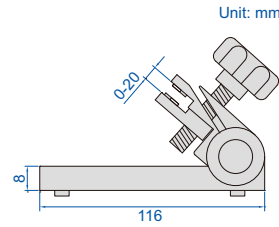

Code
6300

MICROMETER STAND

- Suitable for outside micrometers up to 100mm

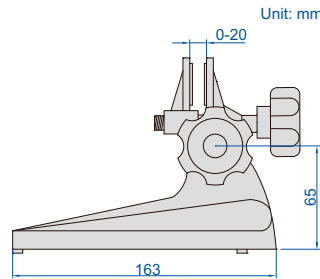

6301

Code
6301

- Suitable for inside micrometers

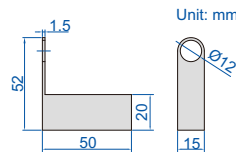

6301-1

Code	Description	Applicable products
6301-1	clamp for inside micrometers	all sizes of 3220 series

- Suitable for three points internal micrometers

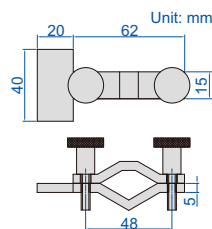

6301-2

Code	Description	Applicable products
6301-2	clamp for three points internal micrometers	up to 100mm of 3127 and 3227 series

MICROMETER SETTING STANDARDS

INSIZE PLUS
MADE IN EUROPE



7386-100

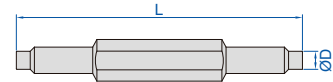

- Suitable for outside micrometers

Code	Length (L)	Accuracy	ØD
7386-25	25mm	±1.25µm	6.5mm
7386-50	50mm	± 1.25µm	6.5mm
7386-75	75mm	± 1.5µm	6.5mm
7386-100	100mm	± 2µm	6.5mm
7386-125	125mm	± 2.5µm	6.5mm
7386-150	150mm	± 2.5µm	6.5mm
7386-175	175mm	± 2.5µm	6.5mm
7386-200	200mm	± 3µm	6.5mm
7386-225	225mm	± 3µm	6.5mm
7386-250	250mm	± 3µm	6.5mm
7386-275	275mm	±3µm	6.5mm
7386-300	300mm	±3µm	10mm
7386-325	325mm	±3.5µm	10mm
7386-350	350mm	±3.5µm	10mm
7386-375	375mm	±3.5µm	10mm
7386-400	400mm	±3.5µm	10mm

Code	Length (L)	Accuracy	ØD
7386-425	425mm	±3.5µm	10mm
7386-450	450mm	±3.5µm	10mm
7386-475	475mm	±3.5µm	10mm
7386-500	500mm	±3.5µm	10mm
7386-525	525mm	±3.5µm	10mm
7386-550	550mm	±3.5µm	10mm
7386-575	575mm	±3.5µm	10mm
7386-600	600mm	±3.5µm	10mm
7386-625	625mm	±4µm	10mm
7386-650	650mm	±4µm	10mm
7386-675	675mm	±4µm	10mm
7386-700	700mm	±4µm	10mm
7386-725	725mm	±4µm	10mm
7386-750	750mm	±4µm	10mm
7386-775	775mm	±4µm	10mm
7386-800	800mm	±4µm	10mm
7386-825	825mm	±4µm	10mm

Code	Length (L)	Accuracy	ØD
7386-850	850mm	±4µm	10mm
7386-875	875mm	±4µm	10mm
7386-900	900mm	±5µm	10mm
7386-925	925mm	±5µm	10mm
7386-950	950mm	±5µm	10mm
7386-975	975mm	±5µm	10mm
7386-1000	1000mm	±5µm	10mm
7386-1050	1050mm	±5µm	10mm
7386-1150	1150mm	±6µm	10mm
7386-1250	1250mm	±7µm	10mm
7386-1350	1350mm	±7µm	10mm
7386-1450	1450mm	±7µm	10mm
7386-1550	1550mm	±9µm	10mm
7386-1650	1650mm	±10µm	10mm
7386-1750	1750mm	±10µm	10mm
7386-1850	1850mm	±11µm	10mm
7386-1950	1950mm	±12µm	10mm

MICROMETER SETTING STANDARDS

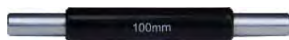

6310-100



type A



6310-300

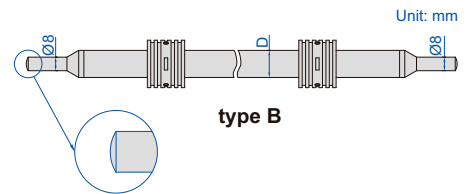

type B

Code	Length	Type	Accuracy	D
6310-25	25	A	±1.5µm	Ø7
6310-50	50	A	±2µm	Ø7
6310-75	75	A	±2.5µm	Ø7
6310-100	100	A	±3µm	Ø8
6310-125	125	A	±3.5µm	Ø8
6310-150	150	A	±4µm	Ø8
6310-175	175	A	±4.5µm	Ø8
6310-200	200	A	±5µm	Ø8
6310-225	225	A	±5.5µm	Ø8
6310-250	250	A	±6µm	Ø8
6310-275	275	A	±6.5µm	Ø8
6310-300	300	B	±7µm	Ø16
6310-325	325	B	±7.5µm	Ø16
6310-350	350	B	±8µm	Ø16
6310-375	375	B	±8.5µm	Ø16

Code	Length	Type	Accuracy	D
6310-400	400	B	±9µm	Ø16
6310-425	425	B	±9.5µm	Ø16
6310-450	450	B	±10µm	Ø16
6310-475	475	B	±10.5µm	Ø16
6310-500	500	B	±11µm	Ø16
6310-525	525	B	±11.5µm	Ø16
6310-575	575	B	±12.5µm	Ø16
6310-625	625	B	±13.5µm	Ø16
6310-675	675	B	±14.5µm	Ø16
6310-725	725	B	±15.5µm	Ø16
6310-775	775	B	±16.5µm	Ø16
6310-825	825	B	±17.5µm	Ø16
6310-875	875	B	±18.5µm	Ø16
6310-925	925	B	±19.5µm	Ø16
6310-975	975	B	±20.5µm	Ø16

Code	Length	Type	Accuracy	D
6310-1050	1050	B	±22µm	Ø23
6310-1150	1150	B	±24µm	Ø23
6310-1250	1250	B	±26µm	Ø23
6310-1350	1350	B	±28µm	Ø23
6310-1450	1450	B	±30µm	Ø23
6310-1550	1550	B	±32µm	Ø23
6310-1650	1650	B	±34µm	Ø23
6310-1750	1750	B	±36µm	Ø23
6310-1850	1850	B	±38µm	Ø23
6310-1950	1950	B	±40µm	Ø23

CALIPER/MICROMETER LAPPING MACHINE CODE 6318



6

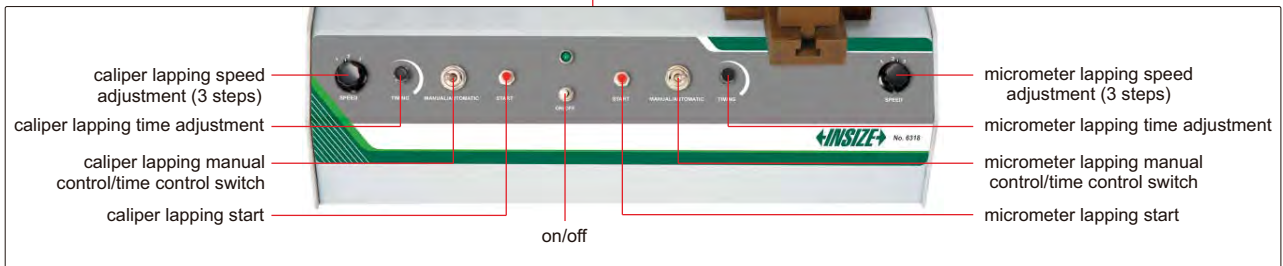

lapping measuring surfaces of caliper lower jaws



lapping measuring surfaces of outside micrometer



- For lapping measuring surfaces of caliper lower jaws and outside micrometers
- Suitable for 0-300mm range calipers and 0-100mm range outside micrometers
- Supplied with lapping block and diamond paste for calipers
- Lapping blocks for micrometers are optional, diamond paste is included
- Optional accessory: micrometer lapping blocks

caliper lapping block (included)



micrometer lapping blocks (code: 6307-1, optional)



SPECIFICATION

Power supply	220V, 50/60Hz
Dimension (L×W×H)	430×400×210mm
Weight	28kg

MICROMETER LAPPING BLOCKS (optional)

Code	For micrometer	Remark
6307-1	0~25mm	includes 4 lapping blocks
6307-2	25~50mm	includes 4 lapping blocks
6307-3	50~75mm	includes 4 lapping blocks
6307-4	75~100mm	includes 4 lapping blocks



MICROMETER LAPPING MACHINE CODE 6307

- Used for lapping micrometer measuring surfaces
- Suitable for 0~100mm outside micrometers
- Supplied with diamond paste
- Optional accessory: micrometer lapping blocks

SPECIFICATION

Power supply	220V, 50/60HZ
Dimension (L×W×H)	360×230×210mm
Weight	15kg

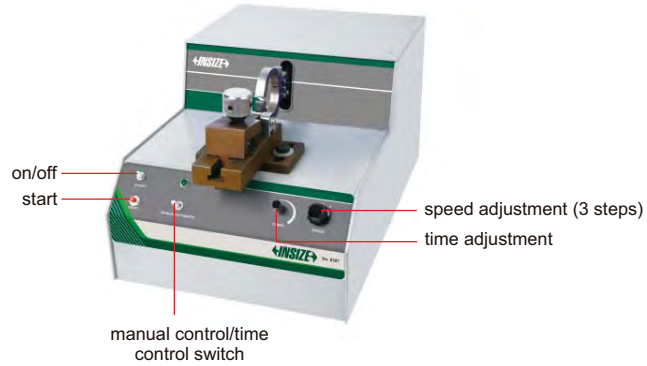

MICROMETER LAPPING BLOCKS (optional)

Code	For micrometer	Remark
6307-1	0~25mm	includes 4 lapping blocks
6307-2	25~50mm	includes 4 lapping blocks
6307-3	50~75mm	includes 4 lapping blocks
6307-4	75~100mm	includes 4 lapping blocks

micrometer lapping blocks (code: 6307-1, optional)



IP65
WATERPROOF

DATA
OUTPUT

DIGITAL MICROMETER HEADS

- Resolution 0.001mm/0.00005"
- IP65 dust/waterproof
- Button function: on/off, set, mm/inch, data transmit
- Data output, automatic power off
- Ratchet stop
- Optional accessory: data output cable (code 7315-31 page 4, 7302-31 page 12)



6353-25W

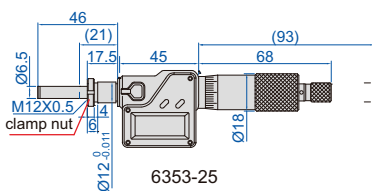

6353-25

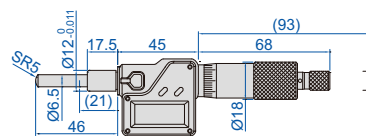

6353-25WS

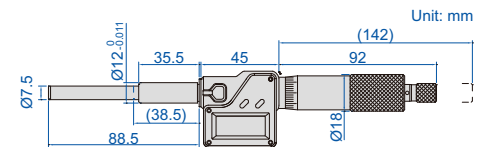

6353-50W

Unit: mm

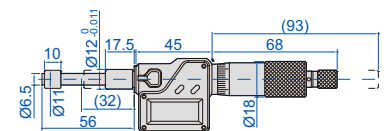

6354-25W

Rotating spindle

Code	Range	Stem	Spindle tip	Accuracy
6353-25	0-25mm/0-1"	with clamp nut	flat (carbide)	±2µm
6353-25W	0-25mm/0-1"	plain	flat (carbide)	±2µm
6353-25S	0-25mm/0-1"	with clamp nut	spherical (SR5)	±2µm
6353-25WS	0-25mm/0-1"	plain	spherical (SR5)	±2µm
6353-50W	0-50mm/0-2"	plain	flat (carbide)	±4µm

Non-rotating spindle

Code	Range	Stem	Spindle tip	Accuracy
6354-25W	0-25mm/0-1"	plain	flat	±2µm

SMALL MICROMETER HEAD

- Graduation 0.02mm

Code	Range	Stem	Spindle tip	Accuracy
6372-5WS	0-5mm	plain	spherical (SR1.5)	5µm



6372-5WS

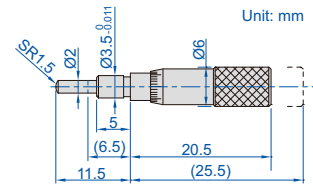

6

SMALL MICROMETER HEADS

- Range 0-6.5mm
- Graduation 0.01mm
- Accuracy 5µm



6385-65W

Code	Stem	Spindle tip
6385-65	with clamp nut	flat
6385-65W	plain	flat
6385-65S	with clamp nut	spherical (SR3)
6385-65WS	plain	spherical (SR3)

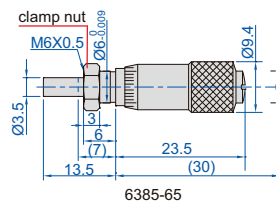

6385-65

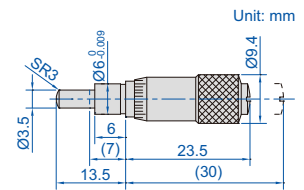

6385-65WS

LARGE THIMBLE MICROMETER HEADS

- Meet DIN863-2
- Large thimble diameter for easy reading
- Graduation 0.01mm
- Accuracy 3µm

Code	Range	Stem	Spindle tip
6373-65	0-6.5mm	with clamp nut	flat
6373-65W	0-6.5mm	plain	flat
6373-65S	0-6.5mm	with clamp nut	spherical (SR3)
6373-65WS	0-6.5mm	plain	spherical (SR3)
6373-13	0-13mm	with clamp nut	flat
6373-13W	0-13mm	plain	flat

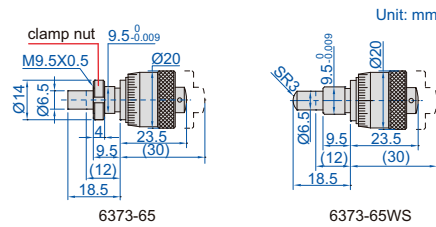

6373-65

6373-65WS



6373-65

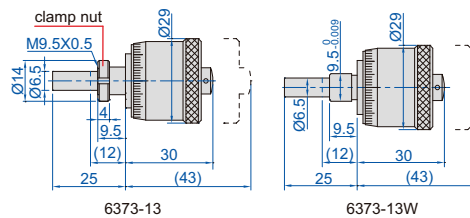

6373-13

6373-13W



6373-13

MICROMETER HEADS WITH ZERO ADJUSTABLE THIMBLE

- Meet DIN863-2
- Range 0-13mm
- Graduation 0.01mm
- Accuracy 3µm
- The thimble can be set to zero at any position

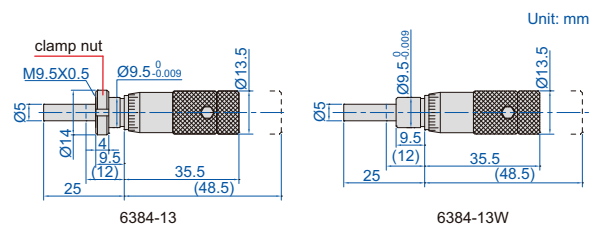

6384-13

6384-13W



6384-13W

Code	Stem	Spindle tip
6384-13	with clamp nut	flat
6384-13W	plain	flat

MICROMETER HEADS

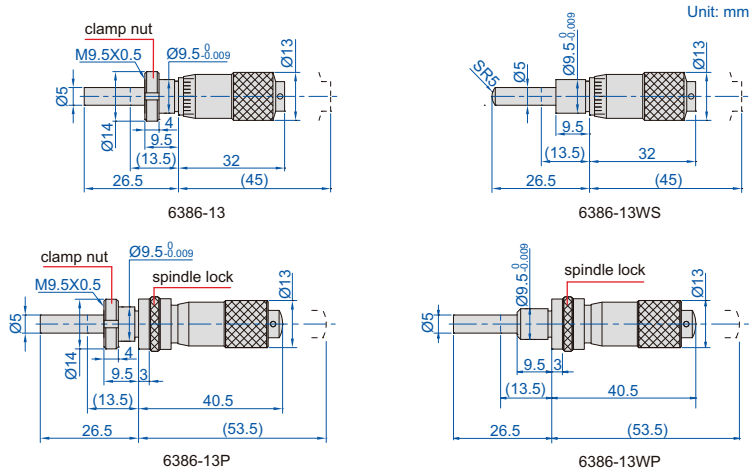

6386-13W



6386-13P

Code	Range	Stem	Spindle tip	Remark	Accuracy
6386-13	0-13mm	with clamp nut	flat		3µm
6386-13W	0-13mm	plain	flat		3µm
6386-13S	0-13mm	with clamp nut	spherical (SR5)		3µm
6386-13WS	0-13mm	plain	spherical (SR5)		3µm
6386-13P	0-13mm	with clamp nut	flat	with spindle lock	3µm
6386-13WP	0-13mm	plain	flat	with spindle lock	3µm

- Meet DIN863-2
- Graduation 0.01mm

MICROMETER HEADS

- Meet DIN863-2
- Graduation 0.01mm
- Accuracy 3µm



6387-15WS

Code	Range	Stem	Spindle tip
6387-15	0-15mm	with clamp nut	flat
6387-15W	0-15mm	plain	flat
6387-15S	0-15mm	with clamp nut	spherical (SR5)
6387-15WS	0-15mm	plain	spherical (SR5)

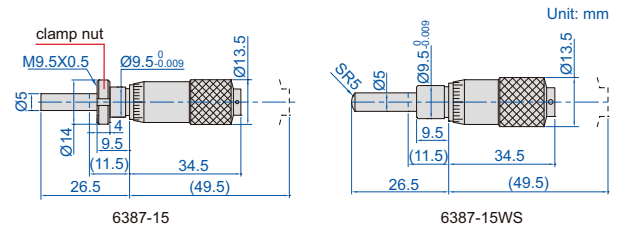

MICROMETER HEADS

- Meet DIN863-2
- Graduation 0.01mm
- Ratchet stop



6381-25



6381-25P

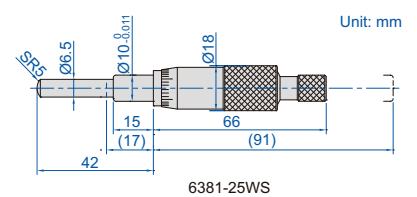
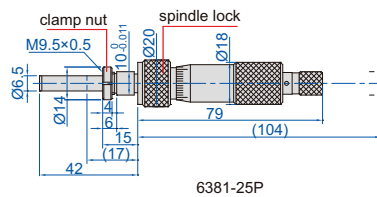
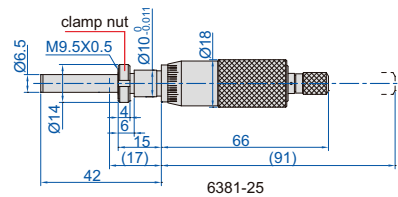

Code	Range	Stem	Spindle tip	Remark	Accuracy
6381-25	0-25mm	with clamp nut	flat (carbide)		3µm
6381-25W	0-25mm	plain	flat (carbide)		3µm
6381-25S	0-25mm	with clamp nut	spherical (SR5)		3µm
6381-25WS	0-25mm	plain	spherical (SR5)		3µm
6381-25P	0-25mm	with clamp nut	flat (carbide)	with spindle lock	3µm
6381-25WP	0-25mm	plain	flat (carbide)	with spindle lock	3µm

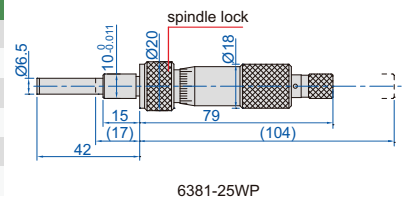

NON-ROTATING SPINDLE MICROMETER HEAD

- Meet DIN863-2
- Graduation 0.01mm
- Ratchet stop
- Non-rotating spindle



6377-25W

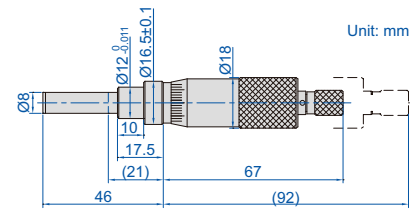

6

Code	Range	Stem	Spindle tip	Accuracy
6377-25W	0-25mm	plain	flat (carbide)	3 μ m

LARGE MICROMETER HEADS



6388-50AW

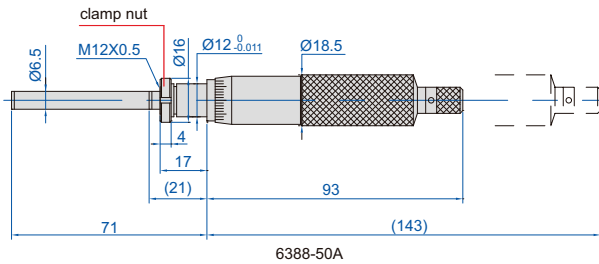

6388-50A

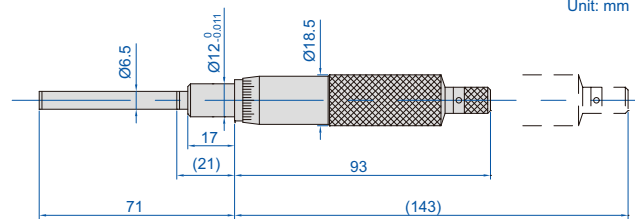

6388-50AW

Code	Range	Stem	Spindle tip	Accuracy
6388-50A	0-50mm	with clamp nut	flat (carbide)	5 μ m
6388-50AW	0-50mm	plain	flat (carbide)	5 μ m

- Graduation 0.01mm
- Ratchet stop

QUICK SPINDLE FEEDING MICROMETER HEADS



6375-15W



6375-25W



6375-50W

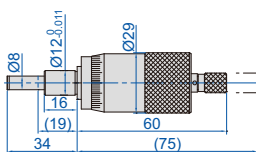

6375-15W

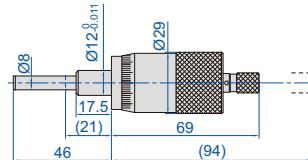

6375-25W

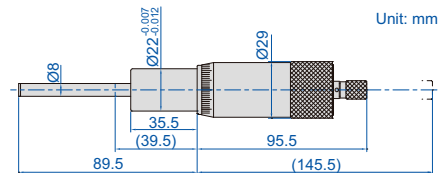

6375-50W

Code	Range	Stem	Spindle tip	Accuracy
6375-15W	0-15mm	plain	flat (carbide)	3 μ m
6375-25W	0-25mm	plain	flat (carbide)	3 μ m
6375-50W	0-50mm	plain	flat (carbide)	5 μ m

- Micrometers up to 25mm meet DIN863-2
- Graduation 0.01mm
- Quick spindle feed of 1mm/rev.
- Ratchet stop

BORE DIAMETER, CIRCUMFERENCE MEASUREMENT

07



Inside Micrometers
Page 158-159



Inside Micrometers
Page 159-166



**Three Points Internal
Micrometers**
Page 167-170



**Pistol Grip Three Points
Bore Gages**
Page 171



Bore Plug Gages
Page 172-173



Bore Gages
Page 174-179



Bore Gage Setters
Page 180-181



Telescoping Gage Sets
Page 181-182



Circumference Tapes
Page 182-183

INSIDE MICROMETERS

INSIZE PLUS
MADE IN EUROPE

**INSPECTION
CERTIFICATE**



3679-55

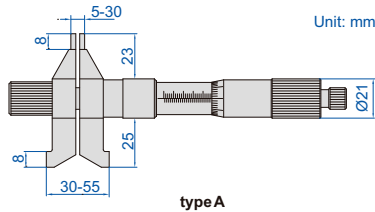

type A



3679-75

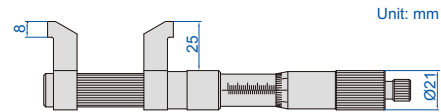

type B

for type A, the upper jaws and lower jaws can be set zero separately



- Graduation: 0.01mm
- Carbide measuring faces
- Ratchet stop
- Optional accessory: setting ring (code **6312**), caliper/height gage checker (code **6884**)

Code	Range	Type	Accuracy
3679-55 *	5-55mm	A	4µm
3679-75 *	50-75mm	B	5µm
3679-100 *	75-100mm	B	6µm
3679-125 *	100-125mm	B	7µm
3679-150 *	125-150mm	B	8µm
3679-175 *	150-175mm	B	9µm
3679-200 *	175-200mm	B	9µm
3679-225 *	200-225mm	B	10µm
3679-250 *	225-250mm	B	10µm
3679-275 *	250-275mm	B	12µm
3679-300 *	275-300mm	B	12µm

* Supplied with manufacturer inspection certificate

Code	Range	Type	Accuracy
3679-325 *	300-325mm	B	15µm
3679-350 *	325-350mm	B	15µm
3679-375 *	350-375mm	B	16µm
3679-400 *	375-400mm	B	16µm
3679-425 *	400-425mm	B	17µm
3679-450 *	425-450mm	B	17µm
3679-475 *	450-475mm	B	18µm
3679-500 *	475-500mm	B	18µm
3679-525 *	500-525mm	B	19µm
3679-550 *	525-550mm	B	19µm
3679-575 *	550-575mm	B	20µm
3679-600 *	575-600mm	B	20µm

INSIDE MICROMETERS (ECONOMIC TYPE)

ATTENTION: LOW PARALLELISM OF TWO MEASURING FACES

- Graduation 0.01mm
- Ratchet stop
- Carbide measuring faces
- Optional accessory: setting ring (code **6312**), micrometer stand and clamp (code **6301** and **6301-1**)

micrometer stand with clamp (optional)

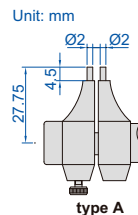

type A



3220-50

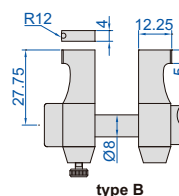

type B

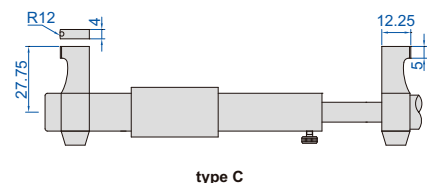

type C

Code	Range	Type	Setting ring	Accuracy
3220-30	5-30mm	A	5mm (included)	7µm
3220-50	25-50mm	B	25mm (included)	8µm
3220-75	50-75mm	B	50mm (optional)	9µm
3220-100	75-100mm	C	75mm (optional)	10µm

DATA OUTPUT

ATTENTION: LOW PARALLELISM OF TWO MEASURING FACES

DIGITAL INSIDE MICROMETERS (ECONOMIC TYPE)

- Resolution 0.001mm/0.00005"
- Button function: on/off, set, mm/inch, data transmit
- Data output
- Automatic power off
- Ratchet stop
- Carbide measuring faces
- Optional accessory: data output cable (code 7315-31 page 4, 7302-31 page 12), setting ring (code 6312)



3520-30

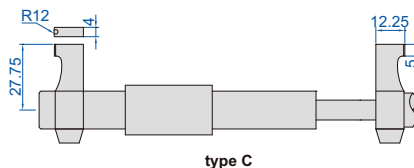
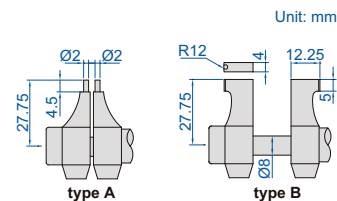

Code	Range	Type	Setting ring	Accuracy
3520-30	5-30mm/0.2-1.2"	A	5mm (included)	$\pm 5\mu\text{m}$
3520-50	25-50mm/1-2"	B	25mm (included)	$\pm 6\mu\text{m}$
3520-75	50-75mm/2-3"	B	50mm (optional)	$\pm 7\mu\text{m}$
3520-100	75-100mm/3-4"	C	75mm (optional)	$\pm 8\mu\text{m}$



INTERNAL GEAR TOOTH MICROMETERS

INSIZE PLUS
MADE IN EUROPE

- Measure over-pin diameter of gears
- Graduation: 0.01mm
- Ratchet stop
- Optional accessory: ball tips (code 7383), cylindrical tips (code 7393, only for micrometers with L=8mm)

before ball tips are installed ball tips are optional



3678-50

cylindrical tips (optional)
(only for micrometers with L=8mm)



Code	Range	Accuracy	L
3678-50*	25-50mm	$4\mu\text{m}$	6mm
3678-75*	50-75mm	$5\mu\text{m}$	8mm

*Supplied with manufacturer inspection certificate

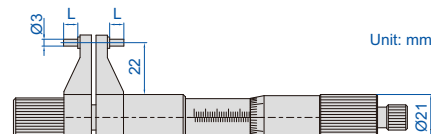
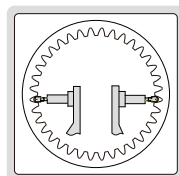

TUBULAR INSIDE MICROMETERS

- Graduation 0.01mm
- Accuracy: $(6+L/50)\mu\text{m}$
L=maximum measuring length (mm)
- Optional accessory: setting ring (code 6312), gage block accessory (code 6881), cylinder gage block (code 4001), caliper/height gage checker (code 6884)



3221-200

Code	Range	Travel of micrometer head	Extension rods
3221-32	25-32mm	7mm	—
3221-50	25-50mm	7mm	2 pcs
3221-63	50-63mm	13mm	—
3221-200	50-200mm	13mm	6 pcs
3221-300	50-300mm	13mm	10 pcs
3221-225	200-225mm	25mm	—
3221-500	200-500mm	25mm	3 pcs
3221-1000	200-1000mm	25mm	8 pcs

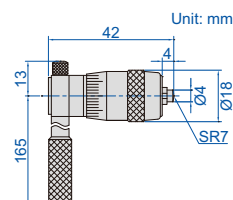

application



TUBULAR INSIDE MICROMETERS

- Micrometers up to 500mm meet DIN863-4
- Graduation 0.01mm
- Carbide measuring faces
- Optional accessory: gage block accessory (code **6881**), cylinder gage block (code **4001**), caliper/height gage checker (code **6884**)



3229-225

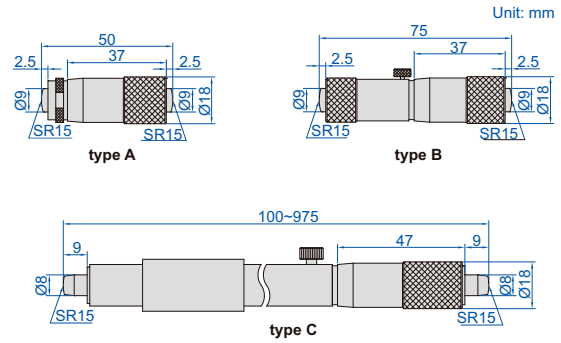

Code	Range	Type	Accuracy
3229-75	50-75mm	A	5µm
3229-100	75-100mm	B	5µm
3229-125	100-125mm	C	6µm
3229-150	125-150mm	C	6µm
3229-175	150-175mm	C	7µm
3229-200	175-200mm	C	7µm
3229-225	200-225mm	C	8µm
3229-250	225-250mm	C	8µm
3229-275	250-275mm	C	9µm
3229-300	275-300mm	C	9µm
3229-325	300-325mm	C	9µm
3229-350	325-350mm	C	9µm
3229-375	350-375mm	C	10µm
3229-400	375-400mm	C	10µm
3229-425	400-425mm	C	10µm
3229-450	425-450mm	C	10µm
3229-475	450-475mm	C	11µm
3229-500	475-500mm	C	11µm
3229-525	500-525mm	C	11µm
3229-550	525-550mm	C	11µm
3229-575	550-575mm	C	11µm
3229-600	575-600mm	C	12µm
3229-625	600-625mm	C	12µm
3229-650	625-650mm	C	12µm
3229-675	650-675mm	C	13µm
3229-700	675-700mm	C	13µm

Code	Range	Type	Accuracy
3229-725	700-725mm	C	13µm
3229-750	725-750mm	C	14µm
3229-775	750-775mm	C	14µm
3229-800	775-800mm	C	14µm
3229-825	800-825mm	C	15µm
3229-850	825-850mm	C	15µm
3229-875	850-875mm	C	15µm
3229-900	875-900mm	C	16µm
3229-925	900-925mm	C	16µm
3229-950	925-950mm	C	16µm
3229-975	950-975mm	C	17µm
3229-1000	975-1000mm	C	17µm

TUBULAR INSIDE MICROMETERS



3224-2000

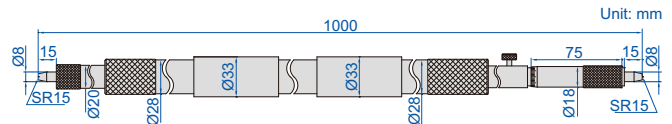

Code	Range	Extension rods
3224-2000	1000-2000mm	50mm, 100mm (2 pcs), 200mm, 500mm
3224-3000	1000-3000mm	50mm, 100mm (2 pcs), 200mm, 500mm, 1000mm
3224-4000	1000-4000mm	50mm, 100mm (2 pcs), 200mm, 500mm, 1000mm (2 pcs)
3224-5000	1000-5000mm	50mm, 100mm (2 pcs), 200mm, 500mm, 1000mm (3 pcs)

- Micrometer head: 1000-1050mm
- Graduation 0.01mm
- Accuracy: $(7+n+L/50)\mu\text{m}$
n=number of rods
L=maximum measuring length (mm)
- Travel of micrometer head 50mm
- Carbide measuring faces

TUBULAR INSIDE MICROMETERS

- Micrometer head: 50-63mm
- Graduation 0.01mm
- Accuracy: $(3+n+L/50)\mu\text{m}$
 n =number of rods
 L =maximum measuring length (mm)
- Supplied with setting standards
- Carbide measuring faces



3222-150

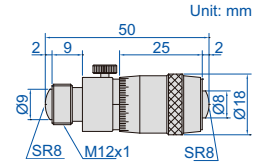

Code	Range	Travel of micrometer head	Extension rods
3222-63	50-63mm	13mm	—
3222-150	50-150mm	13mm	13mm, 25mm, 50mm
3222-300	50-300mm	13mm	13mm, 25mm, 50mm (2 pcs), 100mm
3222-500	50-500mm	13mm	13mm, 25mm, 50mm (2 pcs), 100mm, 200mm
3222-600	50-600mm	13mm	13mm, 25mm, 50mm, 100mm, 150mm, 200mm
3222-1000	50-1000mm	13mm	13mm, 25mm, 50mm (2 pcs), 100mm, 200mm (2 pcs), 300mm
3222-1500	50-1500mm	13mm	13mm, 25mm, 50mm (2 pcs), 100mm, 200mm (3 pcs), 300mm (2 pcs)

TUBULAR INSIDE MICROMETERS

INSIZE PLUS
MADE IN EUROPE



3684-100

- Micrometer head: 50-75mm
- Graduation: 0.01mm
- Carbide measuring faces

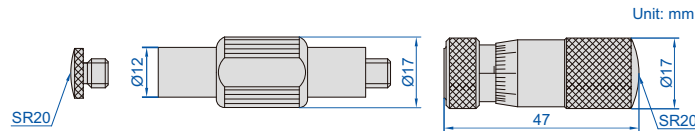

Code	Range	Accuracy	Travel of micrometer head	Extension rods
3684-75	50-75mm	5 μm	25mm	—
3684-100	50-100mm	5 μm	25mm	25mm
3684-150	50-150mm	6 μm	25mm	25mm, 50mm
3684-250	50-250mm	8 μm	25mm	25mm, 50mm, 100mm
3684-300	50-300mm	9 μm	25mm	25mm, 50mm (2 pcs), 100mm
3684-350	50-350mm	10 μm	25mm	25mm, 50mm, 100mm (2 pcs)
3684-450	50-450mm	10 μm	25mm	25mm, 50mm, 100mm, 200mm
3684-650	50-650mm	12 μm	25mm	25mm, 50mm, 100mm, 200mm (2 pcs)
3684-850	50-850mm	15 μm	25mm	25mm, 50mm, 100mm, 200mm, 400mm
3684-1250	50-1250mm	20 μm	25mm	25mm, 50mm, 100mm, 200mm, 400mm (2 pcs)
3684-1450	50-1450mm	22 μm	25mm	25mm, 50mm, 100mm, 200mm, 400mm, 600mm

TUBULAR INSIDE MICROMETERS

INSIZE PLUS
MADE IN EUROPE

7



3683-200

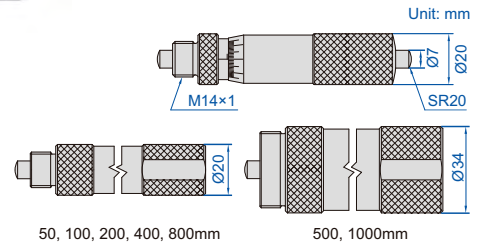

- Micrometer head: 100-150mm
- Graduation: 0.01mm
- Carbide measuring faces
- Heat insulation extension rods

Code	Range	Accuracy	Travel of micrometer head	Heat insulation extension rods
3683-150	100-150mm	6μm	50mm	—
3683-200	100-200mm	7μm	50mm	50mm
3683-300	100-300mm	9μm	50mm	50mm, 100mm
3683-500	100-500mm	13μm	50mm	50mm, 100mm, 200mm
3683-900	100-900mm	16μm	50mm	50mm, 100mm, 200mm, 400mm
3683-1300	100-1300mm	22μm	50mm	50mm, 100mm, 200mm, 400mm (2 pcs)
3683-1700	100-1700mm	27μm	50mm	50mm, 100mm, 200mm, 400mm, 800mm
3683-2000	100-2000mm	32μm	50mm	50mm, 100mm, 200mm (2 pcs), 500mm, 1000mm
3683-2100	100-2100mm	32μm	50mm	50mm, 100mm, 200mm, 400mm (2 pcs), 800mm
3683-2500	100-2500mm	40μm	50mm	50mm, 100mm, 200mm, 400mm, 800mm (2 pcs)
3683-3000	100-3000mm	50μm	50mm	50mm, 100mm, 200mm (2 pcs), 500mm, 1000mm (2 pcs)
3683-4000	100-4000mm	60μm	50mm	50mm, 100mm, 200mm (2 pcs), 500mm, 1000mm (3 pcs)
3683-5000	100-5000mm	72μm	50mm	50mm, 100mm, 200mm (2 pcs), 500mm, 1000mm (4 pcs)
3683-6000	100-6000mm	90μm	50mm	50mm, 100mm, 200mm (2 pcs), 500mm, 1000mm (5 pcs)

TUBULAR INSIDE MICROMETERS

- Micrometer head: 100-125mm
- Graduation 0.01mm
- Accuracy: $(3+n+L/50)\mu\text{m}$
n=number of rods
L=maximum measuring length (mm)
- Travel of micrometer head 25mm
- Supplied with setting standards
- Carbide measuring faces



3225-500

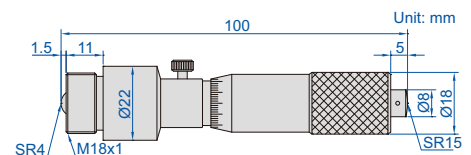

Code	Range	Extension rods
3225-125	100-125mm	—
3225-500	100-500mm	25mm, 50mm, 100mm, 200mm
3225-900	100-900mm	25mm, 50mm, 100mm, 200mm, 400mm
3225-1300	100-1300mm	25mm, 50mm, 100mm, 200mm, 400mm (2 pcs)
3225-1700	100-1700mm	25mm, 50mm, 100mm, 200mm, 400mm (3 pcs)
3225-2100	100-2100mm	25mm, 50mm, 100mm, 200mm, 400mm (4 pcs)

IP65
WATERPROOF

DATA
OUTPUT

DIGITAL TUBULAR INSIDE MICROMETERS

- Micrometer head: 150-175mm
- Graduation: 0.001mm/0.00005"
- Accuracy: $(3+n+L/50)\mu\text{m}$
n=number of rods
L=maximum measuring length (mm)
- Carbide measuring faces
- The diameter of extension rods is 22mm
- IP65 dust/waterproof
- Button function: on/off, set, mm/inch, data transmit
- Data output
- Automatic power off
- Supplied with setting standards
- Optional accessory: data output cable (code 7315-31 page 4, 7302-31 page 12)

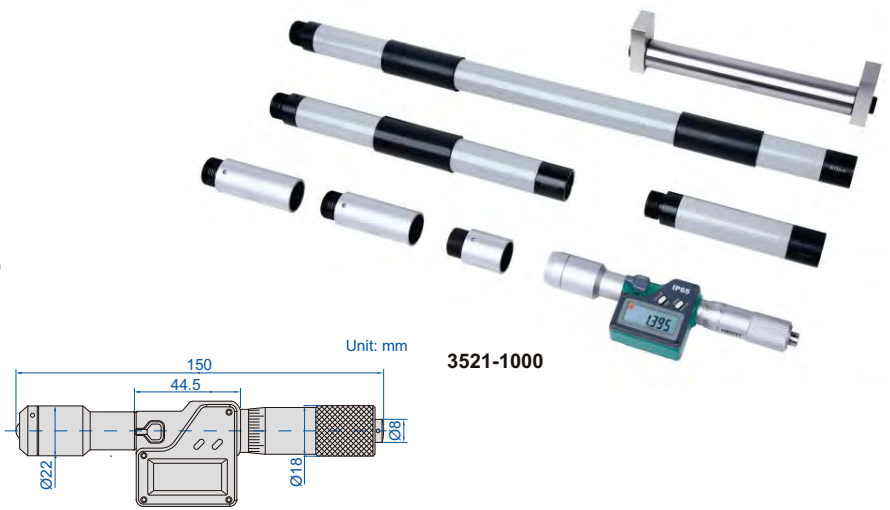

3521-1000

7

Code	Range	Travel of micrometer head	Extension rods
3521-175	150-175mm	25mm	—
3521-1000	150-1000mm	25mm	25mm, 50mm (2 pcs), 100mm, 200mm, 400mm
3521-1500	150-1500mm	25mm	25mm, 50mm (2 pcs), 100mm (2 pcs), 200mm, 400mm (2 pcs)
3521-2000	150-2000mm	25mm	25mm, 50mm (2 pcs), 100mm, 200mm (2 pcs), 400mm (3 pcs)

TUBULAR INSIDE MICROMETERS

INSIZE PLUS
MADE IN EUROPE

- Carbide measuring faces for micrometer head and extension rods
- Points of extension rods are spring loaded
- Optional accessory: gage block accessory (code 6881), cylinder gage block (code 4001), caliper/height gage checker (code 6884)



3634-1300

Micrometer head

Range	Graduation	Accuracy	Weight
100-125mm	0.01mm	$\pm 4\mu\text{m}$	154g

Extension rods

Length (L)	Accuracy	Weight	Material
25mm	$\pm 1.25\mu\text{m}$	37g	steel
50mm	$\pm 1.25\mu\text{m}$	65g	steel
100mm	$\pm 2\mu\text{m}$	113g	steel
200mm	$\pm 3.5\mu\text{m}$	208g	steel
400mm	$\pm 4.5\mu\text{m}$	402g	steel
1000mm	$\pm 7.5\mu\text{m}$	909g	carbon fiber

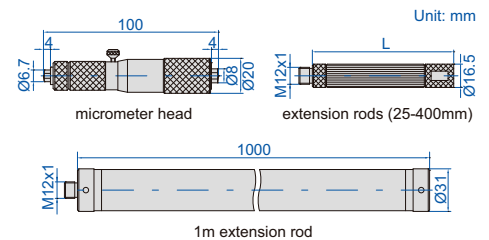

Code	Range	Extension rods
3634-350	100-350mm	25mm, 200mm
3634-500	100-500mm	25mm, 50mm, 100mm, 200mm
3634-1300	100-1300mm	25mm, 50mm, 100mm, 200mm, 400mm (2 pcs)
3634-1500	100-1500mm	25mm, 50mm, 100mm, 200mm (2 pcs), 400mm (2 pcs)
3634-2100	100-2100mm	25mm, 50mm, 100mm, 200mm, 400mm (4 pcs)
3634-3100	100-3100mm	25mm, 50mm, 100mm, 200mm (2 pcs), 400mm, 1000mm (2 pcs)
3634-4100	100-4100mm	25mm, 50mm, 100mm, 200mm (2 pcs), 400mm, 1000mm (3 pcs)
3634-5100	100-5100mm	25mm, 50mm, 100mm, 200mm (2 pcs), 400mm, 1000mm (4 pcs)
3634-6100	100-6100mm	25mm, 50mm, 100mm, 200mm (2 pcs), 400mm, 1000mm (5 pcs)

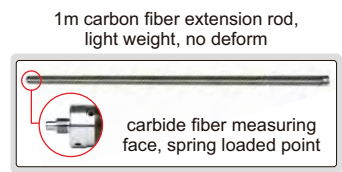

DIGITAL NON-ROTATING SPINDLE TUBULAR INSIDE MICROMETERS

INSIZE PLUS
MADE IN EUROPE

DATA
OUTPUT

SPRING LOADED
MEASURING POINT

NON-ROTATING
SPINDLE

7

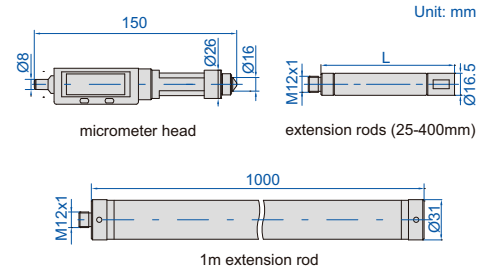

- Carbide measuring faces for micrometer head and extension rods
- Points of extension rods are spring loaded
- Data output
- Button function: mm/inch, max./min. value tracking, preset value, hold, on/off, zero
- CR2032 battery, automatic power off, turn the sleeve to turn on
- Optional accessory: data output cable (code **7315-80**, **7302-80**), gage block accessory (code **6881**), cylinder gage block (code **4001**), caliper/height gage checker (code **6884**)

Extension rods

Length (L)	Accuracy	Weight	Material
25mm	$\pm 1.25\mu\text{m}$	37g	steel
50mm	$\pm 1.25\mu\text{m}$	65g	steel
100mm	$\pm 2\mu\text{m}$	113g	steel
200mm	$\pm 3.5\mu\text{m}$	208g	steel
400mm	$\pm 4.5\mu\text{m}$	402g	steel
1000mm	$\pm 7.5\mu\text{m}$	909g	carbon fiber

Micrometer head

Range	Resolution	Accuracy	Repeatability	Measuring force	Weight
150-180mm	0.001mm/0.00005" 0.01mm/0.0005" 0.0005mm/0.00002" (switchable)	$\pm 4\mu\text{m}$	1 μm	5-10N	275g

Code	Range	Extension rods
3635-350	150-350mm	25mm, 50mm, 100mm
3635-550	150-550mm	25mm, 50mm, 100mm, 200mm
3635-950	150-950mm	25mm, 50mm, 100mm, 200mm, 400mm
3635-1550	150-1550mm	25mm, 50mm, 100mm, 200mm (2 pcs), 400mm (2 pcs)
3635-2150	150-2150mm	25mm, 50mm, 100mm, 200mm, 400mm (4 pcs)
3635-3150	150-3150mm	25mm, 50mm, 100mm, 200mm (2 pcs), 400mm, 1000mm (2 pcs)
3635-4150	150-4150mm	25mm, 50mm, 100mm, 200mm (2 pcs), 400mm, 1000mm (3 pcs)
3635-5150	150-5150mm	25mm, 50mm, 100mm, 200mm (2 pcs), 400mm, 1000mm (4 pcs)
3635-6150	150-6150mm	25mm, 50mm, 100mm, 200mm (2 pcs), 400mm, 1000mm (5 pcs)

1m carbon fiber extension rod,
light weight, no deform

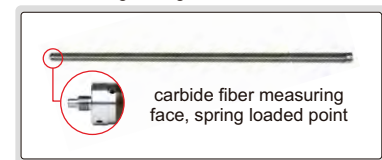

non-rotating spindle, spring loaded point
and max./min. value tracking make it
easy to find the right measuring position

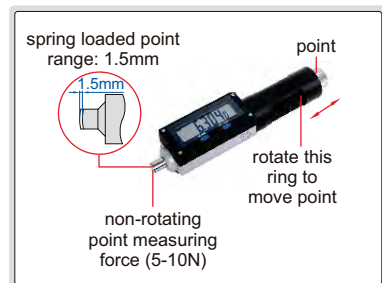

INTERNAL GEAR TOOTH MICROMETERS

INSIZE PLUS
MADE IN EUROPE



3638-200

- Measure over-pin diameter of gears
- Points of extension rods are spring loaded
- Optional accessory: ball tips (code 7383)

Micrometer head

Range	Graduation	Accuracy
100-115mm	0.01mm	±4µm
150-175mm	0.01mm	±4µm

Extension rod

Length (L)	Accuracy
15mm	±1µm
25mm	±1.25µm
30mm	±1.25µm
50mm	±1.25µm
100mm	±2µm
200mm	±3.5µm
400mm	±4.5µm

Code	Range	Micrometer head	Extension rod (L)
3638-200	100-205mm	100-115mm	15mm, 25mm, 50mm
3638-500	100-505mm	100-115mm	15mm, 25mm, 50mm, 100mm, 200mm
3638-900	100-905mm	100-115mm	15mm, 25mm, 50mm, 100mm, 200mm, 400mm
3638-1100	150-1150mm	150-175mm	25mm, 50mm, 100mm, 200mm, 200mm, 400mm

INTERNAL SCREW THREAD MICROMETERS

INSIZE PLUS
MADE IN EUROPE

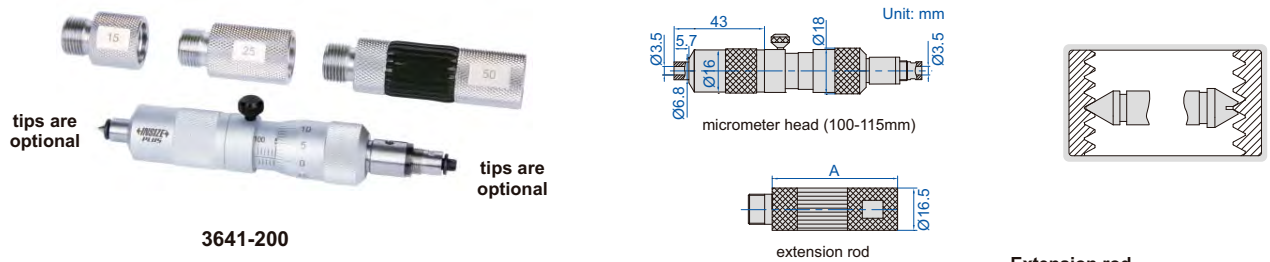

3641-200

- Measure pitch diameter of screw thread
- Points of extension rods are spring loaded
- Optional accessory: measuring tips for internal screw thread micrometer (code 7385, L=13.5mm)

Micrometer head

Range	Graduation	Accuracy
100-115mm	0.01mm	±4µm
150-175mm	0.01mm	±4µm

Extension rod

Length (A)	Accuracy
15mm	±1µm
25mm	±1.25µm
50mm	±1.25µm
100mm	±2µm
200mm	±3.5µm
400mm	±4.5µm

Code	Range	Micrometer head	Extension rod (A)	Applicable tips
3641-200	100-205mm	100-115mm	15mm, 25mm, 50mm	stem length L=13.5mm
3641-500	100-505mm	100-115mm	15mm, 25mm, 50mm, 100mm, 200mm	stem length L=13.5mm
3641-900	100-905mm	100-115mm	15mm, 25mm, 50mm, 100mm, 200mm, 400mm	stem length L=13.5mm
3641-1100	150-1150mm	150-175mm	25mm, 50mm, 100mm, 200mm, 200mm, 400mm	stem length L=13.5mm

MEASURING TIPS FOR INTERNAL SCREW THREAD MICROMETERS

INSIZE PLUS
MADE IN EUROPE

TIPS FOR TRAPEZOIDAL, ACME
THREAD ARE ALSO AVAILABLE

- Supplied in pair
- Made of hardened steel
- Suitable for 3641 series micrometers



7385-T106A

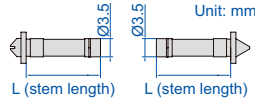

7385-T106B

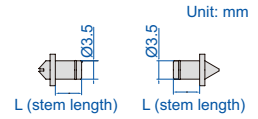

7

60° thread angle

Code		Applicable pitch (mm)
L=13.5mm	L=5mm	
7385-T101A	7385-T101B	0.35
7385-T102A	7385-T102B	0.4/0.45
7385-T103A	7385-T103B	0.5/0.6
7385-T104A	7385-T104B	0.7/0.75/0.8
7385-T105A	7385-T105B	1/1.25
7385-T106A	7385-T106B	1.5/1.75
7385-T107A	7385-T107B	2.0/2.5
7385-T108A	7385-T108B	3.0/3.5
7385-T109A	7385-T109B	4.0/4.5/5.0
7385-T110A	7385-T110B	5.5/6.0

55° thread angle

Code		Applicable pitch (TPI)
L=13.5mm	L=5mm	
7385-T201A	7385-T201B	60/48
7385-T202A	7385-T202B	40/32
7385-T203A	7385-T203B	28/26/24/22
7385-T204A	7385-T204B	20/19/18/16
7385-T205A	7385-T205B	14/12/11
7385-T206A	7385-T206B	10/9/8
7385-T207A	7385-T207B	7/6
7385-T208A	7385-T208B	5/4.5/4
7385-T209A	7385-T209B	3.5/3.25/3/2.875/2.75
7385-T210A	7385-T210B	2.625/2.5/2

INTERNAL SCREW THREAD MICROMETERS

- Graduation: 0.01mm
- Optional accessory: measuring tips for internal screw thread micrometer (code 7321)

Code	Range
3226-1001	75-100mm
3226-1251	100-125mm
3226-1501	125-150mm
3226-1751	150-175mm
3226-2001	175-200mm

Code	Range
3226-2251	200-225mm
3226-2501	225-250mm
3226-2751	250-275mm
3226-3001	275-300mm



measuring tips for screw thread (optional)

measuring tips for screw thread (optional)

3226-1001

measuring tips for internal screw thread micrometer (optional)



MEASURING TIPS FOR INTERNAL SCREW THREAD MICROMETERS

- Supplied in pair
- Suitable for 3226 series micrometers

Metric and unified screw (60° thread angle)

Code	Pitch
7321-T11	0.4-0.5mm/64-48TPI
7321-T12	0.6-0.9mm/44-28TPI
7321-T13	1-1.75mm/24-14TPI
7321-T14	2-3mm/13-9TPI
7321-T15	3.5-5mm/8-5TPI
7321-T16	5.5-7mm/4.5-3.5TPI
7321-T1S	6 pairs/set, including all above tips



7321-T1S

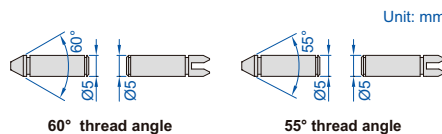

Whitworth screw (55° thread angle)

Code	Pitch
7321-T21	60-48TPI
7321-T22	48-40TPI
7321-T23	40-32TPI
7321-T24	32-24TPI
7321-T25	24-18TPI
7321-T26	18-14TPI
7321-T27	14-10TPI
7321-T28	10-7TPI
7321-T29	7-4.5TPI
7321-T210	4.5-3.5TPI
7321-T2S	10 pairs/set, including all above tips

TWO POINTS/THREE POINTS INTERNAL MICROMETERS

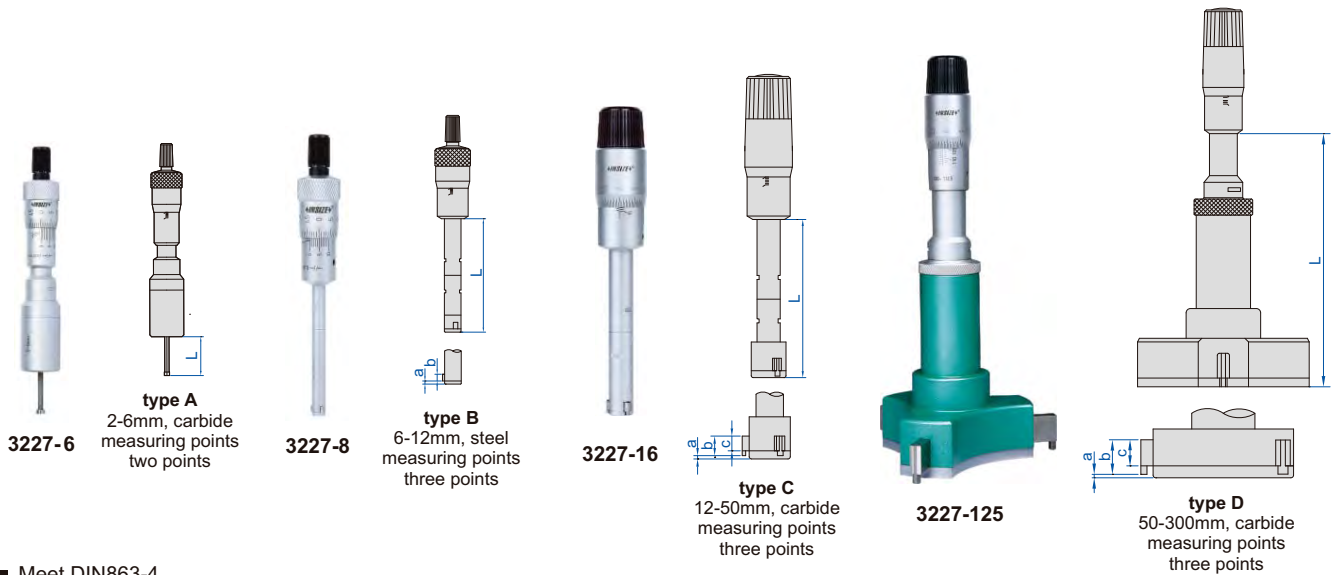

- Meet DIN863-4
- 2-12mm: graduation 0.001mm
12-300mm: graduation 0.005mm
- Ratchet stop
- Optional accessory: setting rings (code **6312**),
micrometer stand and clamp (code **6301** and **6301-2**)

Individual

(mm)

Code	Range	Type	Accuracy	Setting ring	Extension rod (included)	L	a	b	c
3227-2 *	2-2.5mm	A (two points)	6µm	Ø2.5 (included)	—	12	—	—	—
3227-3 *	2.5-3mm	A (two points)	6µm	Ø2.5 (included)	—	12	—	—	—
3227-4 *	3-4mm	A (two points)	6µm	Ø4 (included)	—	22	—	—	—
3227-5 *	4-5mm	A (two points)	6µm	Ø5 (included)	—	22	—	—	—
3227-6 *	5-6mm	A (two points)	6µm	Ø6 (included)	—	22	—	—	—
3227-8 *	6-8mm	B (three points)	4µm	Ø6 (included)	100	54.5	1.5	2.5	—
3227-10 *	8-10mm	B (three points)	4µm	Ø8 (included)	100	54.5	1.5	2.5	—
3227-12 *	10-12mm	B (three points)	4µm	Ø10 (included)	100	54.5	1.5	2.5	—
3227-16 *	12-16mm	C (three points)	4µm	Ø16 (included)	150	80	0.5	6	4.5
3227-20 *	16-20mm	C (three points)	4µm	Ø16 (included)	150	80	0.5	6	4.5
3227-25 *	20-25mm	C (three points)	4µm	Ø25 (included)	150	90	0.5	8	6
3227-30 *	25-30mm	C (three points)	4µm	Ø25 (included)	150	90	0.5	8	6
3227-40 *	30-40mm	C (three points)	4µm	Ø40 (included)	150	97	0.5	14	12
3227-50 *	40-50mm	C (three points)	5µm	Ø40 (included)	150	97	0.5	14	12
3227-63 *	50-63mm	D (three points)	5µm	Ø62 (included)	150	114	0.5	17.5	14.5
3227-75 *	62-75mm	D (three points)	5µm	Ø62 (included)	150	114	0.5	17.5	14.5
3227-88 *	75-88mm	D (three points)	5µm	Ø87 (included)	150	114	0.5	17.5	14.5
3227-100 *	87-100mm	D (three points)	5µm	Ø87 (included)	150	114	0.5	17.5	14.5
3227-125 *	100-125mm	D (three points)	6µm	optional	150	140	0.9	29	25
3227-150 *	125-150mm	D (three points)	6µm	optional	150	140	0.9	29	25
3227-175 *	150-175mm	D (three points)	7µm	optional	150	140	0.9	29	25
3227-200 *	175-200mm	D (three points)	7µm	optional	150	140	0.9	29	25
3227-225	200-225mm	D (three points)	8µm	optional	150	140	0.9	29	25
3227-250	225-250mm	D (three points)	8µm	optional	150	140	0.9	29	25
3227-275	250-275mm	D (three points)	9µm	optional	150	140	0.9	29	25
3227-300	275-300mm	D (three points)	9µm	optional	150	140	0.9	29	25

To be continued

Continued from previous page

micrometer stand with clamp (optional)



setting ring



2-100mm: included
100-300mm: optional

extension rod

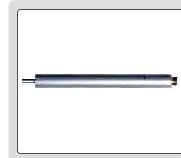

included



3227-504

Set

Code	Range	Micrometers included	Setting ring (included)	Extension rod (included)
3227-232 *	2-3mm	2-2.5mm, 2.5-3mm	Ø2.5mm	—
3227-363 *	3-6mm	3-4mm, 4-5mm, 5-6mm	Ø4mm, Ø5mm, Ø6mm	—
3227-123 *	6-12mm	6-8mm, 8-10mm, 10-12mm	Ø6mm, Ø8mm, Ø10mm	100mm
3227-202 *	12-20mm	12-16mm, 16-20mm	Ø16mm	150mm
3227-504 *	20-50mm	20-25mm, 25-30mm, 30-40mm, 40-50mm	Ø25mm, Ø40mm	150mm
3227-1004 *	50-100mm	50-63mm, 62-75mm, 75-88mm, 87-100mm	Ø62mm, Ø87mm	150mm

* Supplied with manufacturer inspection certificate

DIGITAL TWO POINTS/THREE POINTS INTERNAL MICROMETERS

IP65
WATERPROOF

DATA
OUTPUT



3127-5

type A
2-6mm, carbide measuring points two points



3127-12

type B
6-12mm, steel measuring points three points



3127-40

type C
12-50mm, carbide measuring points three points



3127-125

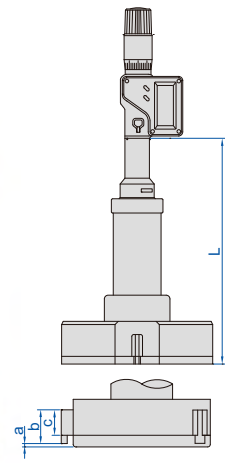

type D
50-300mm, carbide measuring points three points

- Resolution 0.001mm/0.00005" (resolution of 3127-275 and 3127-300 is 0.001mm/0.0001")
- IP65 dust/waterproof
- Buttons: on/off, set, mm/inch, data transmit
- Data output
- Automatic power off
- Ratchet stop
- Optional accessory: data output cable (code 7315-31 page 4, 7302-31 page 12), setting ring (code 6312), micrometer stand and clamp (code 6301 and 6301-2)

To be continued

Continued from previous page

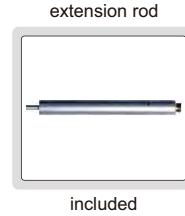

3127-202

Individual

(mm)

Code	Range	Type	Accuracy	Setting ring	Extension rod (included)	L	a	b	c
3127-2*	2-2.5mm/0.08-0.10"	A (two points)	6µm	Ø2.5 (included)	—	12	—	—	—
3127-3*	2.5-3mm/0.10-0.12"	A (two points)	6µm	Ø2.5 (included)	—	12	—	—	—
3127-4*	3-4mm/0.12-0.16"	A (two points)	6µm	Ø4 (included)	—	22	—	—	—
3127-5*	4-5mm/0.16-0.20"	A (two points)	6µm	Ø5 (included)	—	22	—	—	—
3127-6*	5-6mm/0.20-0.24"	A (two points)	6µm	Ø6 (included)	—	22	—	—	—
3127-8*	6-8mm/0.24-0.31"	B (three points)	4µm	Ø6 (included)	100	57	1.5	2.5	—
3127-10*	8-10mm/0.31-0.39"	B (three points)	4µm	Ø8 (included)	100	57	1.5	2.5	—
3127-12*	10-12mm/0.39-0.47"	B (three points)	4µm	Ø10 (included)	100	57	1.5	2.5	—
3127-16*	12-16mm/0.47-0.63"	C (three points)	4µm	Ø16 (included)	150	99	0.5	6	4.5
3127-20*	16-20mm/0.63-0.79"	C (three points)	4µm	Ø16 (included)	150	99	0.5	6	4.5
3127-25*	20-25mm/0.79-0.98"	C (three points)	4µm	Ø25 (included)	150	105	0.5	8	6
3127-30*	25-30mm/0.98-1.18"	C (three points)	4µm	Ø25 (included)	150	105	0.5	8	6
3127-40*	30-40mm/1.18-1.57"	C (three points)	4µm	Ø40 (included)	150	110	0.5	14	12
3127-50*	40-50mm/1.57-1.97"	C (three points)	5µm	Ø40 (included)	150	110	0.5	14	12
3127-63*	50-63mm/1.97-2.48"	D (three points)	5µm	Ø62 (included)	150	127	0.5	17.5	14.5
3127-75*	62-75mm/2.44-2.95"	D (three points)	5µm	Ø62 (included)	150	127	0.5	17.5	14.5
3127-88*	75-88mm/2.95-3.46"	D (three points)	5µm	Ø87 (included)	150	127	0.5	17.5	14.5
3127-100*	87-100mm/3.43-3.94"	D (three points)	5µm	Ø87 (included)	150	127	0.5	17.5	14.5
3127-125*	100-125mm/3.94-4.92"	D (three points)	6µm	optional	150	175	0.9	29	25
3127-150*	125-150mm/4.92-5.91"	D (three points)	6µm	optional	150	175	0.9	29	25
3127-175*	150-175mm/5.91-6.89"	D (three points)	7µm	optional	150	175	0.9	29	25
3127-200*	175-200mm/6.89-7.87"	D (three points)	7µm	optional	150	175	0.9	29	25
3127-225	200-225mm/7.87-8.86"	D (three points)	8µm	optional	150	175	0.9	29	25
3127-250	225-250mm/8.86-9.84"	D (three points)	8µm	optional	150	175	0.9	29	25
3127-275	250-275mm/9.84-10.83"	D (three points)	9µm	optional	150	175	0.9	29	25
3127-300	275-300mm/10.83-11.81"	D (three points)	9µm	optional	150	175	0.9	29	25

Set

Code	Range	Micrometers included	Setting ring (included)	Extension rod (included)
3127-232*	2-3mm/0.08-0.12"	2-2.5mm, 2.5-3mm	Ø2.5mm	—
3127-363*	3-6mm/0.12-0.24"	3-4mm, 4-5mm, 5-6mm	Ø4mm, Ø5mm, Ø6mm	—
3127-123*	6-12mm/0.24-0.47"	6-8mm, 8-10mm, 10-12mm	Ø6mm, Ø8mm, Ø10mm	100mm
3127-202*	12-20mm/0.47-0.79"	12-16mm, 16-20mm	Ø16mm	150mm
3127-504*	20-50mm/0.79-1.97"	20-25mm, 25-30mm, 30-40mm, 40-50mm	Ø25mm, Ø40mm	150mm
3127-1004*	50-100mm/1.97-3.94"	50-63mm, 62-75mm, 75-88mm, 87-100mm	Ø62mm, Ø87mm	150mm

* Supplied with manufacturer inspection certificate

WIDE RANGE THREE POINTS INTERNAL MICROMETERS



7

- Meet DIN863-4
- Graduation 0.001mm
- Carbide measuring faces
- Ratchet stop
- Setting rings are included (except 200-300mm)

Code	Range	Accuracy	Setting ring
3228-70*	50-70mm	5µm	Ø50mm (included)
3228-100*	70-100mm	5µm	Ø70mm (included)
3228-150*	100-150mm	6µm	Ø100mm (included)
3228-250*	150-250mm	8µm	Ø150mm (included)
3228-300*	200-300mm	9µm	Ø200mm (optional)

*Supplied with manufacturer inspection certificate



3228-70

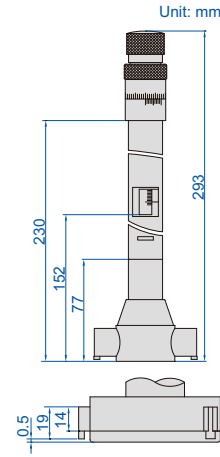

setting ring

DIGITAL WIDE RANGE THREE POINTS INTERNAL MICROMETERS



- Meet DIN863-4
- Resolution 0.001mm/0.00005" (resolution of **3128-300** is 0.001mm/0.0001")
- IP54 dust/waterproof
- Buttons: on/off, set, mm/inch, ABS/INC
- Data output
- Automatic power off
- Carbide measuring faces
- Ratchet stop
- Supplied with extension rods
- Setting rings are included (except 200-300mm)
- Optional accessory: data output cable (code **7315-30** page 4, **7302-30** page 12)



3128-70

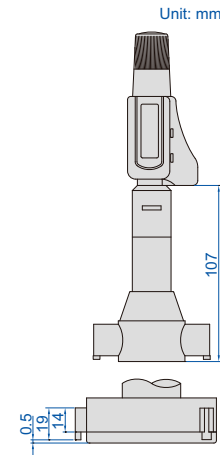

setting ring



extension rod (included)

Code	Range	Accuracy	Setting ring	Extension rod (included)
3128-70*	50-70mm/1.97-2.76"	5µm	Ø50mm (included)	150mm
3128-100*	70-100mm/2.76-3.94"	5µm	Ø70mm (included)	150mm
3128-150*	100-150mm/3.94-5.91"	6µm	Ø100mm (included)	150mm
3128-250*	150-250mm/5.91-9.84"	8µm	Ø150mm (included)	150mm
3128-300*	200-300mm/7.87-11.81"	9µm	Ø200mm (optional)	150mm

*Supplied with manufacturer inspection certificate



PISTOL GRIP THREE POINTS BORE GAGES

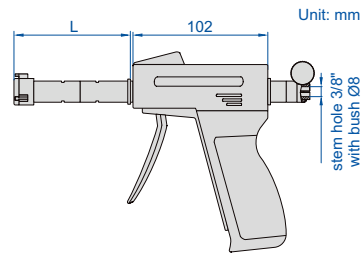

- Optional accessory:
digital indicators (code **2108-101F**, resolution 0.001mm/0.00005"),
setting rings (code **6312**)

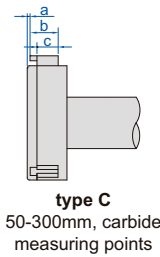
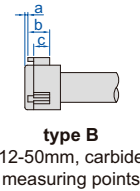
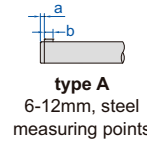
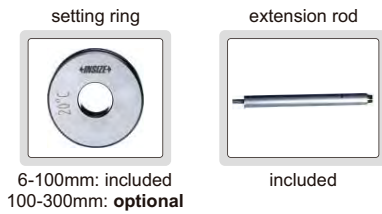

Individual

(mm)

Code	Range	Type	Accuracy (without digital indicator)	Setting ring	Extension rod (included)	L	a	b	c
2124-8 *	6-8mm	A	4µm	Ø6mm (included)	100mm	50	1.5	2.5	—
2124-10 *	8-10mm	A	4µm	Ø8mm (included)	100mm	50	1.5	2.5	—
2124-12 *	10-12mm	A	4µm	Ø10mm (included)	100mm	50	1.5	2.5	—
2124-16 *	12-16mm	B	4µm	Ø16mm (included)	150mm	65	0.5	6	4.5
2124-20 *	16-20mm	B	4µm	Ø16mm (included)	150mm	65	0.5	6	4.5
2124-25 *	20-25mm	B	4µm	Ø25mm (included)	150mm	91	0.5	8	6
2124-30 *	25-30mm	B	4µm	Ø25mm (included)	150mm	91	0.5	8	6
2124-40 *	30-40mm	B	4µm	Ø40mm (included)	150mm	97	0.5	14	12
2124-50 *	40-50mm	B	5µm	Ø40mm (included)	150mm	97	0.5	14	12
2124-63 *	50-63mm	C	5µm	Ø62mm (included)	150mm	112	0.5	17.5	14.5
2124-75 *	62-75mm	C	5µm	Ø62mm (included)	150mm	112	0.5	17.5	14.5
2124-88 *	75-88mm	C	5µm	Ø87mm (included)	150mm	112	0.5	17.5	14.5
2124-100 *	87-100mm	C	5µm	Ø87mm (included)	150mm	112	0.5	17.5	14.5
2124-125 *	100-125mm	C	6µm	optional	150mm	140	0.9	29	25
2124-150 *	125-150mm	C	6µm	optional	150mm	140	0.9	29	25
2124-175 *	150-175mm	C	7µm	optional	150mm	140	0.9	29	25
2124-200 *	175-200mm	C	7µm	optional	150mm	140	0.9	29	25
2124-225	200-225mm	C	8µm	optional	150mm	140	0.9	29	25
2124-250	225-250mm	C	8µm	optional	150mm	140	0.9	29	25
2124-275	250-275mm	C	9µm	optional	150mm	140	0.9	29	25
2124-300	275-300mm	C	9µm	optional	150mm	140	0.9	29	25

Set

Code	Range	Probes included	Setting ring (included)	Extension rod (included)
2124-S123 *	6-12mm	6-8mm, 8-10mm, 10-12mm	Ø6mm, Ø8mm, Ø10mm	100mm
2124-S202 *	12-20mm	12-16mm, 16-20mm	Ø16mm	150mm
2124-S504 *	20-50mm	20-25mm, 25-30mm, 30-40mm, 40-50mm	Ø25mm, Ø40mm	150mm
2124-S1004 *	50-100mm	50-63mm, 62-75mm, 75-88mm, 87-100mm	Ø62mm, Ø87mm	150mm



2124-S504

* Supplied with manufacturer inspection certificate

BORE PLUG GAGES

INSIZE PLUS
MADE IN EUROPE



7

digital indicator
is optional

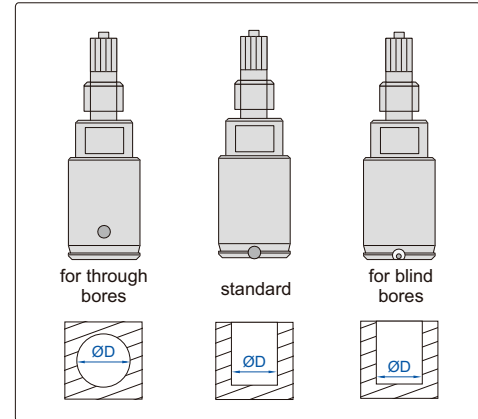
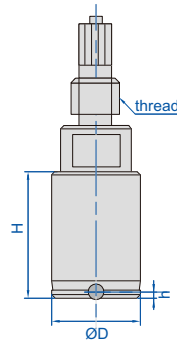
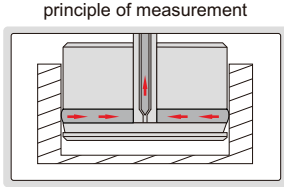

- TiN coating provides very good hardness (2200 HV), corrosion resistance with outstanding sliding and friction characteristics

SPECIFICATION OF PROBE

(mm)

Range (ØD)	6-8 *	8-10	10-20	20-50	50-100	100-130	130-280
Travel of point	0.15	0.15	0.15	0.20	0.20	0.20	0.20
Thread	M6x0.75			M10x1			
Height of point (h)	for through bores	5	5	5	6	7.5	10
	standard	1.6	1.6	1.6	2.5	2.5	2.5
Height of probe (H)	for blind bores	—	—	0.6	1.2	1.2	—
	for through bores	27	27	27	29	33.5	36
	standard	23.5	23.5	23.5	25.5	28.5	28.5
for blind bores	—	—	23.5	—	28.5	28.5	—
Repeatability	0.001						

* When measuring range is 6-8mm, we suggest to use Ø7.5mm extension rod;
When measuring range is 6-8mm, it has insertion chamfer for self-centering

To be continued

Continued from previous page



PROBE

Code	Type
4683-NO□□□□	for through bores
4683-XK□□□□	standard
4683-SL□□□□	for blind bores

SETTING RING

Code
6312-□□□□□

Ordering examples:

Code	Type	Range
4683-NO38D10H7	for through bores	38.10H7

Attention: "D" stands for "°".

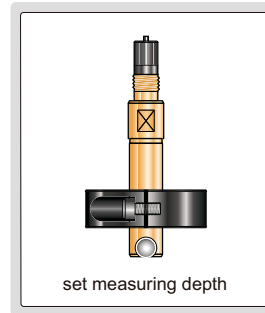

4683-G

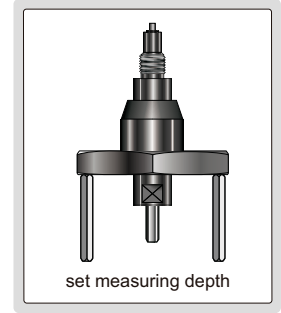

4683-J

DEPTH STOP

Code	Applicable for probe
4683-G□□□□□	6.0~85mm
4683-J□□□□□	28~150mm

Ordering examples:

Code	Applicable for probe
4683-G22H7	22H7



HANDLE

Code	Length (L)	Diameter (ØD)	Thread
4683-HM50S	50mm	8mm	M6x0.75
4683-HM100S	100mm	8mm	M6x0.75
4683-HM150S*	150mm	8mm	M6x0.75
4683-HM60	60mm	15mm	M10x1
4683-HM150*	150mm	15mm	M10x1

* The length 150mm are fabricated of temperature-stable steel



EXTENSION ROD FOR HANDLE

Code	Length (H)	Diameter (ØD)	Thread
4683-VL65T	65mm	7.5mm	M6x0.75
4683-VL50S	50mm	8mm	M6x0.75
4683-VL100S*	100mm	8mm	M6x0.75
4683-VL150S*	150mm	8mm	M6x0.75
4683-VL250S*	250mm	8mm	M6x0.75
4683-VL50	50mm	15mm	M10x1
4683-VL100*	100mm	15mm	M10x1
4683-VL150*	150mm	15mm	M10x1
4683-VL250*	250mm	15mm	M10x1

* The length 100mm and above are fabricated of temperature-stable steel

90° ADAPTER

Code	Thread
4683-WS1	M6x0.75
4683-WS2	M10x1

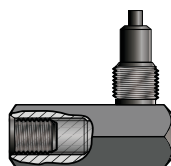

PRECISION BORE GAGES FOR SMALL HOLES

7

with digital indicator

read the diameter directly, after inputting the size of setting ring.



the minimum value tracking function can find the diameter automatically.

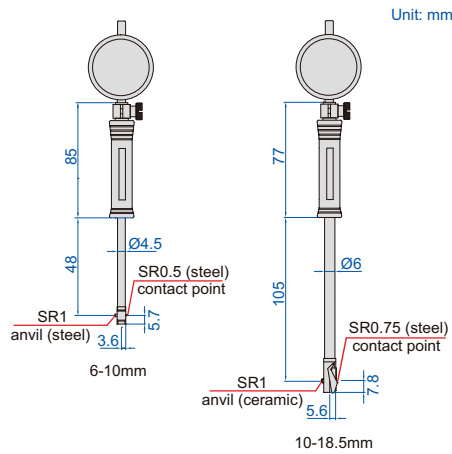

Unit: mm



2853-10

2153-18

- Optional accessory: setting ring (code 6312), bore gage setter

With dial indicator

Code	Range	Indicator	Accuracy	Repeatability
2853-10	6-10mm	dial indicator, range 1mm, graduation 0.001mm (code 2313-1FA)	±0.007mm	0.0015mm
2853-18	10-18.5mm		±0.007mm	0.0015mm

With digital indicator (data output cable code 7315-50M page 5, 7302-40M page 13, optional)

Code	Range	Indicator	Accuracy	Repeatability
2153-10	6-10mm	digital indicator, code 2108-101F, range 12.7mm/0.5", resolution 0.001mm/0.00005"	±0.007mm	0.002mm
2153-18	10-18.5mm		±0.007mm	0.002mm

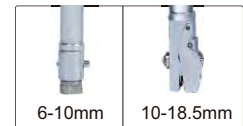

BORE GAGES FOR SMALL HOLES

ATTENTION: NOT SUITABLE FOR 0.001MM DIAL INDICATORS

with digital indicator

read the diameter directly, after inputting the size of setting ring.



the minimum value tracking function can find the diameter automatically.

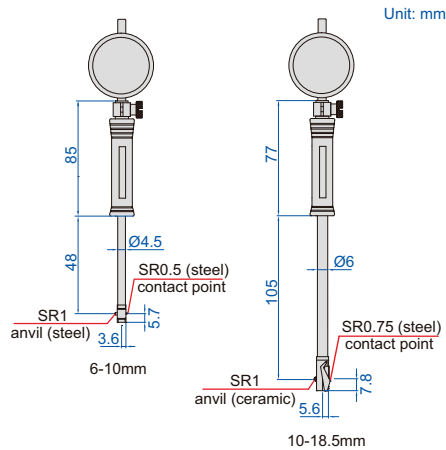
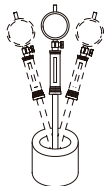

Unit: mm

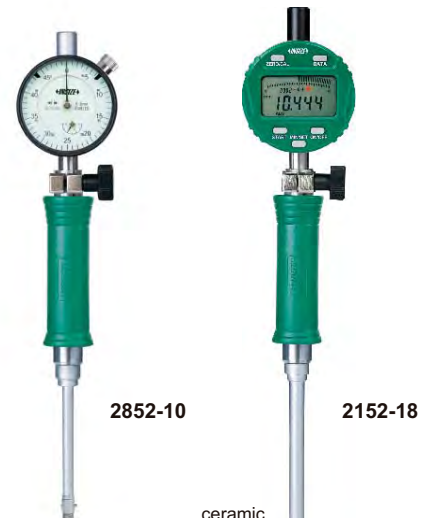

2852-10

2152-18

- Optional accessory: setting ring (code 6312), bore gage setter

With dial indicator

Code	Range	Indicator	Accuracy	Repeatability
2852-10	6-10mm	dial indicator, range 3mm, graduation 0.01mm (code 2311-3F)	±0.012mm	0.003mm
2852-18	10-18.5mm		±0.012mm	0.003mm

With digital indicator (data output cable code 7315-50M page 5, 7302-40M page 13, optional)

Code	Range	Indicator	Accuracy	Repeatability
2152-10	6-10mm	digital indicator, code 2108-10F, range 12.7mm/0.5", resolution 0.002mm/0.0001" (can switch to: 0.01mm/0.0005")	±0.012mm	0.003mm
2152-18	10-18.5mm		±0.012mm	0.003mm



PRECISION BORE GAGES

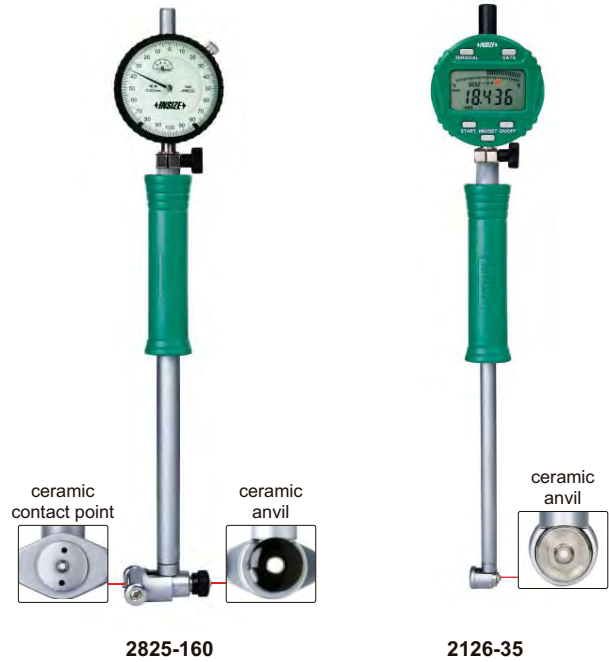
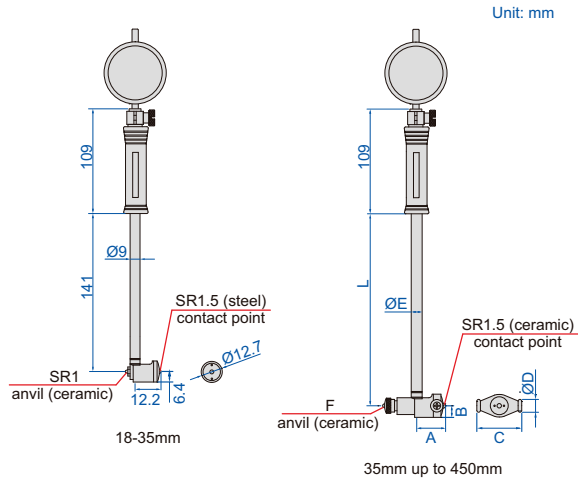

- Optional accessory: setting ring (code **6312**), bore gage setter

(mm)							
Range	A	B	C	ØD	ØE	F	L
35-60mm	22	9	27	13	12.8	SR2	141
50-100mm	26	9	35	13	12.8	SR2	141
50-160mm	26	9	35	13	12.8	SR2	141
100-160mm	26	9	35	13	12.8	SR2	141
160-250mm	56.5	13	74.5	15	12.8	SR2	241
250-450mm	86.5	15	101.5	15	14.5	SR2.5	241

With dial indicator

Code	Range	Indicator	Accuracy	Repeatability
2825-35	18-35mm	dial indicator, range 1mm, graduation 0.001mm (code 2313-1FA)	±0.007mm	0.0015mm
2825-60	35-60mm		±0.007mm	0.0015mm
2825-100	50-100mm		±0.007mm	0.0015mm
2825-160	50-160mm		±0.007mm	0.0015mm
2825-161	100-160mm		±0.007mm	0.0015mm
2825-250	160-250mm		±0.007mm	0.0015mm
2825-450	250-450mm		±0.007mm	0.0015mm

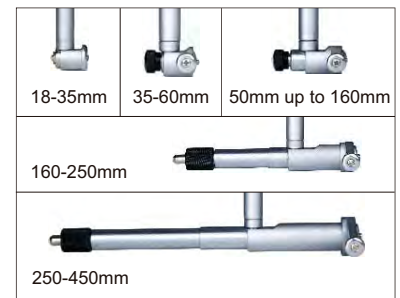

With digital indicator

(data output cable code **7315-50M** page 5, **7302-40M** page 13, optional)

Code	Range	Indicator	Accuracy	Repeatability
2126-35	18-35mm	digital indicator, code 2108-101F , range 12.7mm/0.5", resolution 0.001mm/0.00005"	±0.007mm	0.002mm
2126-60	35-60mm		±0.007mm	0.002mm
2126-100	50-100mm		±0.007mm	0.002mm
2126-160	50-160mm		±0.007mm	0.002mm
2126-161	100-160mm		±0.007mm	0.002mm
2126-250	160-250mm		±0.007mm	0.002mm
2126-450	250-450mm		±0.007mm	0.002mm

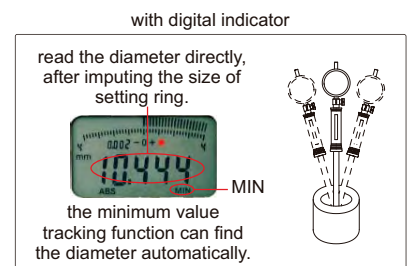

BORE GAGES

POPULAR MODEL

ATTENTION: NOT SUITABLE FOR 0.001MM DIAL INDICATORS



7

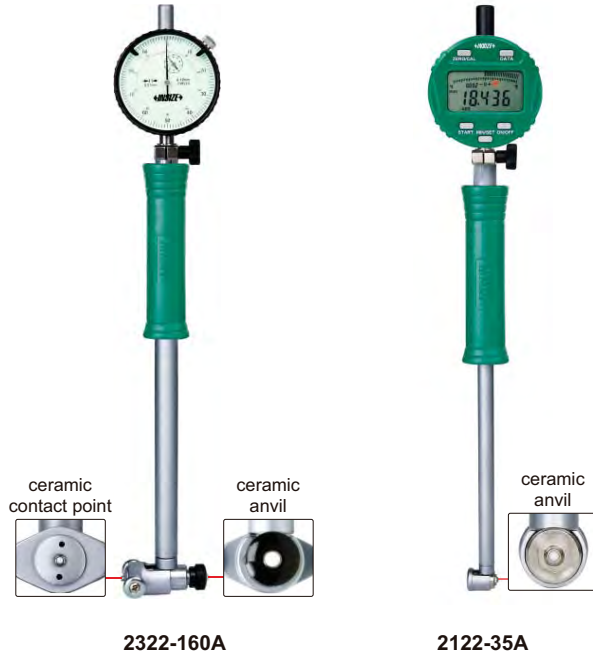
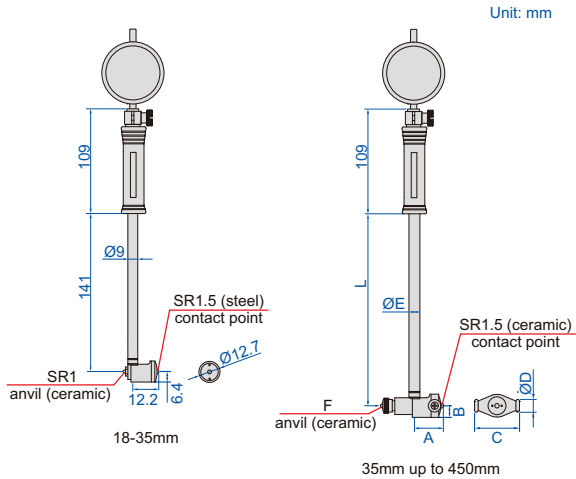

- Optional accessory: setting ring (code **6312**), long handle (code **7351**), bore gage setter

(mm)							
Range	A	B	C	ØD	ØE	F	L
35-60mm	22	9	27	13	12.8	SR2	141
50-100mm	26	9	35	13	12.8	SR2	141
50-160mm	26	9	35	13	12.8	SR2	141
100-160mm	26	9	35	13	12.8	SR2	141
160-250mm	56.5	13	74.5	15	12.8	SR2	241
250-450mm	86.5	15	101.5	15	14.5	SR2.5	241

With dial indicator

Code	Range	Indicator	Accuracy	Repeatability
2322-35A	18-35mm	dial indicator, range 10mm, graduation 0.01mm (code 2308-10FA)	±0.015mm	0.003mm
2322-60A	35-60mm		±0.018mm	0.003mm
2322-100A	50-100mm		±0.018mm	0.003mm
2322-160A	50-160mm		±0.018mm	0.003mm
2322-161A	100-160mm		±0.018mm	0.003mm
2322-250A	160-250mm		±0.018mm	0.003mm
2322-450A	250-450mm		±0.018mm	0.003mm

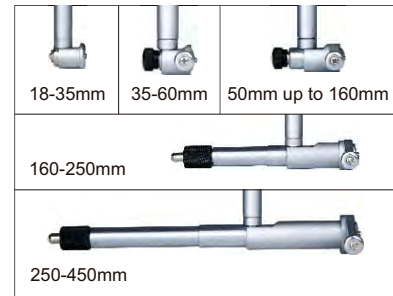

With digital indicator

(data output cable code **7315-50M** page 5, **7302-40M** page 13, optional)

Code	Range	Indicator	Accuracy	Repeatability
2122-35A	18-35mm	digital indicator, code 2108-10F , range 12.7mm/0.5", resolution 0.002mm/0.0001" (can switch to: 0.01mm/0.0005")	±0.015mm	0.003mm
2122-60A	35-60mm		±0.018mm	0.003mm
2122-100A	50-100mm		±0.018mm	0.003mm
2122-160A	50-160mm		±0.018mm	0.003mm
2122-161A	100-160mm		±0.018mm	0.003mm
2122-250A	160-250mm		±0.018mm	0.003mm
2122-450A	250-450mm		±0.018mm	0.003mm

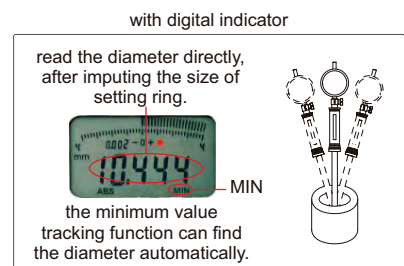

ATTENTION: NOT SUITABLE FOR 0.001MM DIAL INDICATORS

BORE GAGES

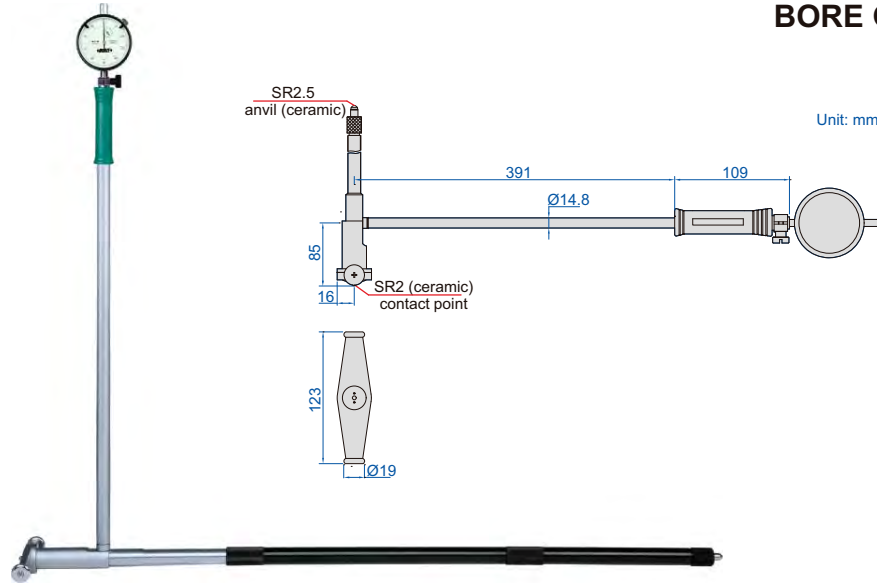

2828-800A

With dial indicator

Code	Range	Indicator	Accuracy	Repeatability
2828-800A	400-800mm	dial indicator, code 2308-10FA, range 10mm, graduation 0.01mm	±0.025mm	0.003mm

With digital indicator (data output cable code 7315-50M page 5, 7302-40M page 13, optional)

Code	Range	Indicator	Accuracy	Repeatability
2128-800A	400-800mm	digital indicator, code 2108-10F, range 12.7mm/0.5", resolution 0.002mm/0.0001" (can switch to: 0.01mm/0.0005")	±0.025mm	0.003mm

ATTENTION: NOT SUITABLE FOR 0.001MM DIAL INDICATORS

BORE GAGES

- Optional accessory: setting ring (code 6312), long handle (code 7351), bore gage setter

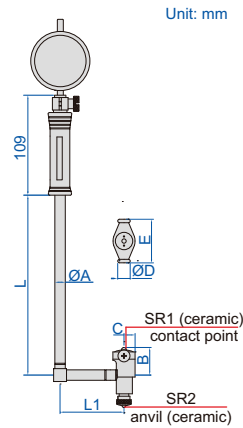
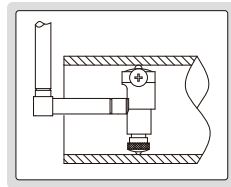

2827-160A

with digital indicator

(mm)							
Range	ØA	B	C	ØD	E	L	L1
35-60mm	12.8	22	9	13	27	141	75
50-160mm	12.8	28.5	9.2	13	35	141	76.2
160-250mm	14.5	62.0	12.7	15	74.5	391	100
250-450mm	14.5	91.5	15.0	15	101.5	391	100

With dial indicator

Code	Range	Indicator	Accuracy	Repeatability
2827-60A	35-60mm	dial indicator, code 2308-10FA, range 10mm, graduation 0.01mm	±0.018mm	0.003mm
2827-160A	50-160mm		±0.018mm	0.003mm
2827-250A	160-250mm		±0.018mm	0.003mm
2827-450A	250-450mm		±0.018mm	0.003mm

With digital indicator

(data output cable code 7315-50M page 5, 7302-40M page 13, optional)

Code	Range	Indicator	Accuracy	Repeatability
2127-60	35-60mm	digital indicator, code 2108-10F, range 12.7mm/0.5", resolution 0.002mm/0.0001" (can switch to: 0.01mm/0.0005")	±0.018mm	0.003mm
2127-160	50-160mm		±0.018mm	0.003mm
2127-250	160-250mm		±0.018mm	0.003mm
2127-450	250-450mm		±0.018mm	0.003mm

read the diameter directly, after inputting the size of setting ring.



the minimum value tracking function can find the diameter automatically.

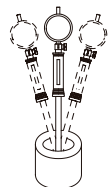

BORE GAGE SETS

ATTENTION: NOT SUITABLE FOR 0.001MM DIAL INDICATORS

7



2824-S160

2724-S3

- Optional accessory: setting ring (code 6312), long handle (code 7351), bore gage setter

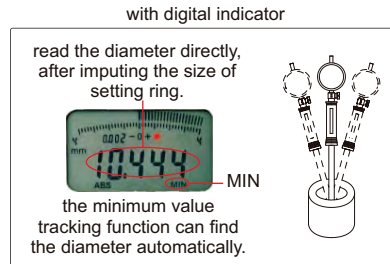

packaging (code 2824-S3)

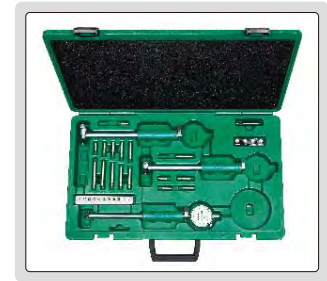

With dial indicator

Code	Range	Indicator	Bore gages included	Accuracy	Repeatability
2824-S160	35-160mm	dial indicator, code 2308-10FA, range 10mm, graduation 0.01mm	① 35-50mm (dial indicator and handle are not included) ② 50-160mm	35-50mm $\pm 0.018\text{mm}$ 50-160mm $\pm 0.018\text{mm}$	0.003mm
2824-S3	18-160mm	dial indicator, code 2308-10FA, range 10mm, graduation 0.01mm	① 18-35mm ② 35-60mm (dial indicator is not included) ③ 50-160mm (dial indicator is not included)	18-35mm $\pm 0.015\text{mm}$ 35-60mm $\pm 0.018\text{mm}$ 50-160mm $\pm 0.018\text{mm}$	0.003mm

With digital indicator (data output cable code 7315-50M page 5, 7302-40M page 13, optional)

Code	Range	Indicator	Bore gages included	Accuracy	Repeatability
2724-S160	35-160mm	digital indicator, code 2108-10F range 12.7mm/0.5", resolution 0.002mm/0.0001" (can switch to: 0.01mm/0.0005")	① 35-50mm (digital indicator and handle are not included) ② 50-160mm	35-50mm $\pm 0.018\text{mm}$ 50-160mm $\pm 0.018\text{mm}$	0.003mm
2724-S3	18-160mm	digital indicator, code 2108-10F range 12.7mm/0.5", resolution 0.002mm/0.0001" (can switch to: 0.01mm/0.0005")	① 18-35mm ② 35-60mm (digital indicator is not included) ③ 50-160mm (digital indicator is not included)	18-35mm $\pm 0.015\text{mm}$ 35-60mm $\pm 0.018\text{mm}$ 50-160mm $\pm 0.018\text{mm}$	0.003mm

ATTENTION: NOT SUITABLE FOR 0.001MM DIAL INDICATORS

MEASURE DIAMETER OF BORES WITH BARRIER INSIDE

BORE GAGE FOR BARRIER INSIDE BORE

application



digital indicator is optional

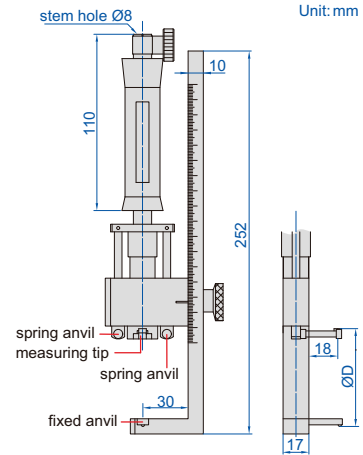

2348-210

(mm)

Code	Range ØD	Diameter of barrier Ød	Travel of measuring tip	Accuracy (without dial indicator)	Measuring force
2348-210	40-210mm	<D-14 (less than 50mm)*	1.6	0.018	2N

*For example:

When measuring size ØD is 40mm, D-14=26mm, so the diameter of barrier should be less than 26mm.

When measuring size ØD is 70mm, D-14=56mm, however it should be less than 50mm, so the diameter of barrier should be less than 50mm.

- To assist deep-hole measurement
- Can be used for bore gages 2122, 2322, 2824, 2724, 2127 and 2827

method of use (replace the original handle with long handle)

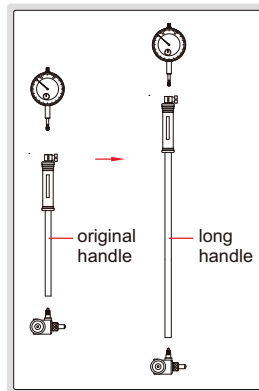

LONG HANDLES

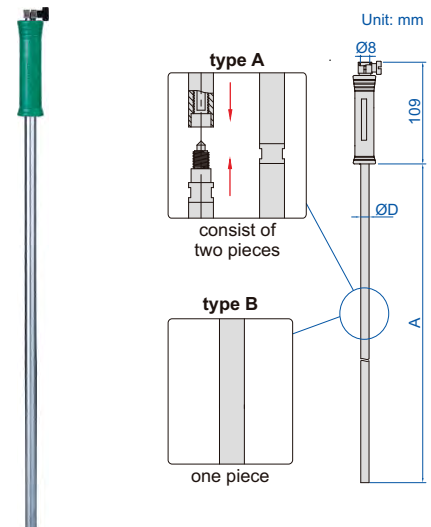

7351-EX11

Code	Applicable bore gages	A	ØD	Type
7351-EX11	35-60mm, 50-100mm, 50-160mm, 100-160mm	475mm	13mm	B
7351-EX12		980mm	13mm	
7351-EX13		1480mm	14.5mm	A
7351-EX14		1980mm	14.5mm	
7351-EX21	160-250mm, 250-450mm	480mm	14.5mm	B
7351-EX22		980mm	14.5mm	A
7351-EX23		1480mm	14.5mm	
7351-EX24		1980mm	14.5mm	

ANVILS FOR BORE GAGES

7

- For bore gages 2852, 2152, 2322, 2122, 2127, 2724, 2825, 2126, 2824, 2853, 2153 and 2827



7350-160

Code	Applicable bore gages	Material of measuring face	Quantity per set	Measuring range of anvil (mm)
7350-10	6-10mm	steel	9 pcs	6, 6.5, 7, 7.5, 8, 8.5, 9, 9.5, 10
7350-18	10-18.5mm	ceramic	9 pcs	10, 11, 12, 13, 14, 15, 16, 17, 18
7350-35	18-35mm	ceramic	9 pcs	18, 20, 22, 24, 26, 28, 30, 32, 34
7350-60	35-60mm	ceramic	6 pcs	35, 40, 45, 50, 55, 60
7350-100	50-100mm	ceramic	11 pcs	50, 55, 60, 65, 70, 75, 80, 85, 90, 95, 100
7350-160	50-160mm	ceramic	12 pcs	50, 55, 60, 65, 70, 75, 80, 85, 90, 95, 100, 105
7350-161	100-160mm	ceramic	12 pcs	50, 55, 60, 65, 70, 75, 80, 85, 90, 95, 100, 105
7350-250	160-250mm	ceramic	5 pcs	160, 170, 180, 190, 200
7350-450	250-450mm	ceramic	5 pcs	250, 260, 270, 280, 290

BORE GAGE SETTERS

- Vertical and horizontal use
- To be used with gage blocks

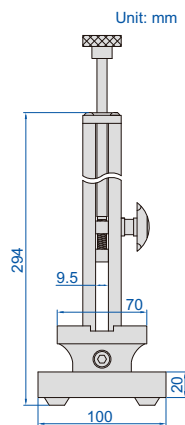
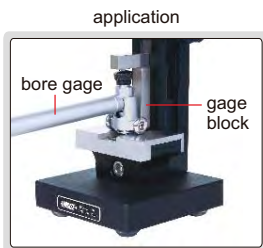

7353-160



gage blocks for 7353-160



Code	Range	Repeatability	Remark
7353-160	0-160mm	1.2µm	with gage block set
7353-160W	0-160mm	1.2µm	without gage block set

Gage block set for 7353-160

Blocks per set	Size (mm)	Step (mm)	Quantity	Remark
33	1.005	0.01	1 pc	grade 2 (ISO3650)
	1.01-1.09		9 pcs	
	1.1-1.9		9 pcs	
	1-9	1	9 pcs	
	10-30	10	3 pcs	
	50	1 pc		
	100		1 pc	



BORE GAGE SETTER

- Used together with gage blocks to set bore gages

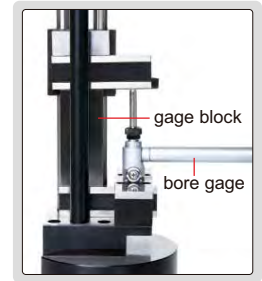
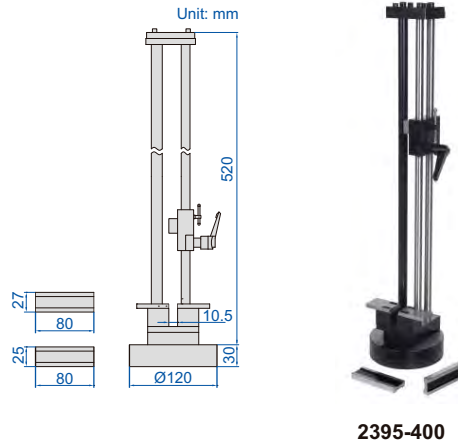

Code	Setting range
2395-400	18-400mm

2395-400

SMALL HOLE GAGE SET

- 4 gages per set
- For small holes, slots and grooves, etc.
- Satin chrome finish

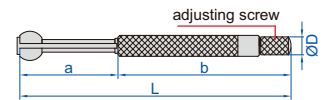
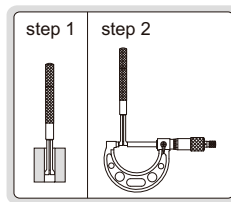

4208-1

Range	L	a	b	ØD
3-5mm	76	24	52	5
5-7.5mm	79	27	52	5
7.5-10mm	88	30	58	6
10-13mm	91	34	58	6

Code	Total range	Gages included
4208-1	3-13mm	3-5mm, 5-7.5mm, 7.5-10mm, 10-13mm

TELESCOPING GAGE SET

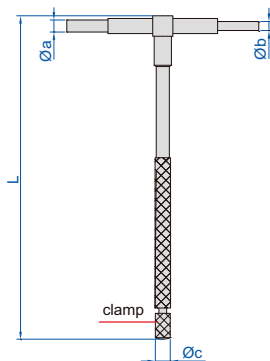

4206-1

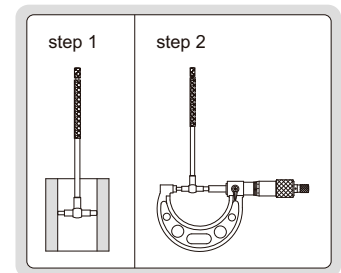

- 6 gages per set
- For quick measurement of inside diameter of holes and width of slots
- Satin chrome finish

Range	L	Øa	Øb	Øc
8-12.7mm	115	3.9	2.9	6.2
12.7-19mm	115	5.3	3.8	6.2
19-32mm	115	5.3	3.8	6.2
32-54mm	137	7.6	6.1	7.2
54-90mm	137	7.6	6.1	7.2
90-150mm	137	7.6	6.1	7.2

Code	Total range	Gages included
4206-1	8-150mm	8-12.7mm, 12.7-19mm, 19-32mm, 32-54mm, 54-90mm, 90-150mm

LONG HANDLE TELESCOPING GAGES

- For quick measurement of inside diameter of deep holes and width of slots
- Satin chrome finish

7

Code	Range	L	\varnothing_a	\varnothing_b	\varnothing_c
4209-1	8-12.7mm	300	3.9	2.9	6.2
4209-2	12.7-19mm	300	5.3	3.8	6.2
4209-3	19-32mm	300	5.3	3.8	6.2
4209-4	32-54mm	300	7.6	6.1	7.2
4209-5	54-90mm	300	7.6	6.1	7.2
4209-6	90-150mm	300	7.6	6.1	7.2

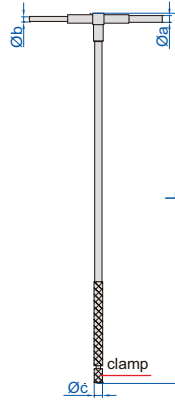

4209-6

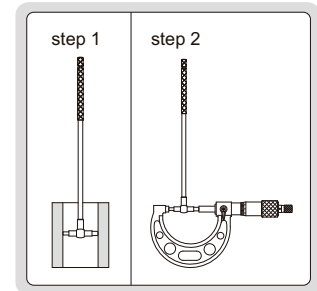

DIAMETER TAPES

CAN BE CUSTOM-MADE



7135-525

- Measure diameter of pipes, trees, tires, etc.
- Made of stainless steel



Code	Diameter range	Graduation	Accuracy
7135-35*	Ø20-35mm	0.05mm	±0.05mm
7135-55*	Ø30-55mm	0.05mm	±0.05mm
7135-125	Ø50-125mm	0.01mm	±0.05mm
7135-225	Ø100-225mm	0.01mm	±0.05mm
7135-375	Ø200-375mm	0.01mm	±0.05mm
7135-525	Ø350-525mm	0.01mm	±0.05mm
7135-725	Ø500-725mm	0.01mm	±0.06mm
7135-925	Ø700-925mm	0.01mm	±0.06mm
7135-1125	Ø900-1125mm	0.02mm	±0.06mm
7135-1325	Ø1100-1325mm	0.02mm	±0.08mm
7135-1525	Ø1300-1525mm	0.02mm	±0.08mm
7135-1725	Ø1500-1725mm	0.02mm	±0.08mm
7135-1925	Ø1700-1925mm	0.02mm	±0.08mm
7135-2125	Ø1900-2125mm	0.02mm	±0.08mm
7135-2325	Ø2100-2325mm	0.02mm	±0.10mm
7135-2525	Ø2300-2525mm	0.02mm	±0.10mm
7135-2750	Ø2500-2750mm	0.02mm	±0.10mm
7135-3000	Ø2750-3000mm	0.02mm	±0.10mm
7135-3250	Ø3000-3250mm	0.02mm	±0.15mm
7135-3500	Ø3250-3500mm	0.02mm	±0.15mm

Code	Diameter range	Graduation	Accuracy
7135-3750	Ø3500-3750mm	0.02mm	±0.15mm
7135-4000	Ø3750-4000mm	0.02mm	±0.20mm
7135-4250	Ø4000-4250mm	0.02mm	±0.20mm
7135-4500	Ø4250-4500mm	0.02mm	±0.20mm
7135-4750	Ø4500-4750mm	0.02mm	±0.20mm
7135-5000	Ø4750-5000mm	0.02mm	±0.20mm
7135-5250	Ø5000-5250mm	0.02mm	±0.005%L**
7135-5500	Ø5250-5500mm	0.02mm	±0.005%L**
7135-5750	Ø5500-5750mm	0.02mm	±0.005%L**
7135-6000	Ø5750-6000mm	0.02mm	±0.005%L**
7135-6250	Ø6000-6250mm	0.02mm	±0.005%L**
7135-6500	Ø6250-6500mm	0.02mm	±0.005%L**
7135-6750	Ø6500-6750mm	0.02mm	±0.005%L**
7135-7000	Ø6750-7000mm	0.02mm	±0.005%L**
7135-7250	Ø7000-7250mm	0.02mm	±0.005%L**
7135-7500	Ø7250-7500mm	0.02mm	±0.005%L**
7135-7750	Ø7500-7750mm	0.02mm	±0.005%L**
7135-8000	Ø7750-8000mm	0.02mm	±0.005%L**
7135-8250	Ø8000-8250mm	0.02mm	±0.005%L**

** L is the actual measured value (unit: mm)

* The thickness of code 7135-35 and 7135-55 is 0.10mm, while the thickness of other codes is 0.25mm

CAN BE CUSTOM-MADE

CIRCUMFERENCE TAPES

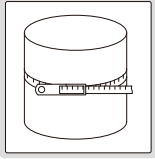

7136-1880

- Measure diameter and circumference of pipes, trees, tires, etc.
- Made of stainless steel

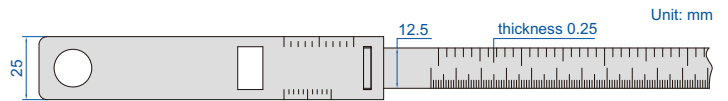

Code	Circumference range	Diameter range	Graduation	Accuracy	
				circumference	diameter
7136-940	160-940mm	Ø50-300mm	0.1mm	±0.30mm	±0.10mm
7136-1880	940-1880mm	Ø300-600mm	0.1mm	±0.30mm	±0.10mm
7136-2830	1880-2830mm	Ø600-900mm	0.1mm	±0.30mm	±0.10mm
7136-3770	2830-3770mm	Ø900-1200mm	0.1mm	±0.30mm	±0.10mm
7136-4710	3770-4710mm	Ø1200-1500mm	0.1mm	±0.30mm	±0.10mm
7136-5650	4710-5650mm	Ø1500-1800mm	0.1mm	±0.30mm	±0.10mm
7136-6600	5650-6600mm	Ø1800-2100mm	0.1mm	±0.30mm	±0.10mm
7136-7540	6600-7540mm	Ø2100-2400mm	0.1mm	±0.30mm	±0.10mm
7136-8480	7540-8480mm	Ø2400-2700mm	0.1mm	±0.30mm	±0.10mm
7136-9430	8480-9430mm	Ø2700-3000mm	0.1mm	±0.30mm	±0.10mm

CIRCUMFERENCE TAPES (ECONOMIC TYPE)

- Measure diameter and circumference of soft materials like pipes, trees, tires, etc.
- Graduation: 0.1mm
- Laser engraved scale
- Made of stainless steel



7114-950

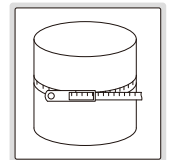

Code	Circumference range	Diameter range	Accuracy	
			circumference	diameter
7114-950	150-950mm	Ø50-300mm	±3mm	±1mm
7114-2200	940-2200mm	Ø300-700mm	±3mm	±1mm
7114-3460	2190-3460mm	Ø700-1100mm	±3mm	±1mm

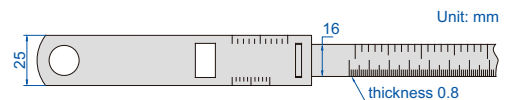

TAPER GAGES

REFER TO PAGE 374 FOR DETAILS

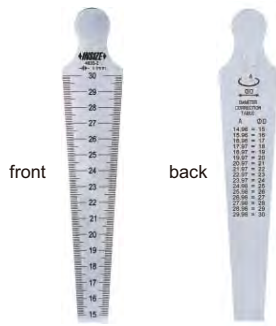

4833-2

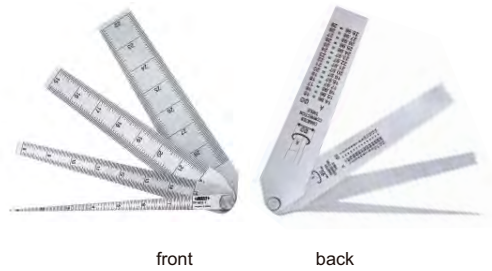

TAPER GAGE SET
4837-1

TAPER BORE GAGES

REFER TO PAGE 375 FOR DETAILS



4852-15

SMALL TAPER BORE GAGE

REFER TO PAGE 375 FOR DETAILS



4855-5

INSIDE SPRING CALIPERS

REFER TO PAGE 383 FOR DETAILS



7261-150



Large Diameter Gages
Page 186



Outside Diameter Variation Measuring
Instruments
Page 187



Outside Diameter Measuring
Instruments
Page 188



Digital Radius Gages
Page 189



Digital Radius Gages
Page 190-191



Digital Arc Radius Calipers
Page 191



Digital Radius Calipers
Page 192



Radius Gages
Page 192

LARGE DIAMETER GAGE CODE ISQ-RA600

INSIZE PLUS
MADE IN EUROPE

DATA
OUTPUT



8

- To measure large external or internal diameters
- Automatic judgment and display external or internal diameter
- Backlight LCD display, can rotate 180° for easy reading
- Memory of 12 readings and average calculation
- With minimum and maximum measurement mode
- Angle can be displayed



software flash disk
(included)

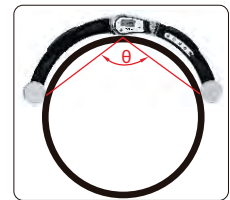

display of angle



external diameter measurement



internal diameter measurement



software (included),
data output, save and print

SPECIFICATION

Range	external	Ø500~6000mm/19.69~236.22"
	internal	Ø1100~6000mm/43.31~236.22"
Resolution	0.01mm/0.001"	
Accuracy	±(0.01+D²/30)mm (D is the diameter to be measured, in meter)	
Power supply	rechargeable battery (for 8 hours working)	
Weight	3.8kg	

Accuracy sample by diameters

Diameter	Accuracy
500mm	±0.018mm
1000mm	±0.043mm
1500mm	±0.085mm
2000mm	±0.143mm
2500mm	±0.218mm
3000mm	±0.310mm
4000mm	±0.543mm
5000mm	±0.843mm
6000mm	±1.210mm

STANDARD DELIVERY

Main unit	1 pc
AC/DC adapter	1 pc
Software and USB cable	1 pc

CAN BE
CUSTOM-MADE

OUTSIDE DIAMETER VARIATION MEASURING INSTRUMENTS

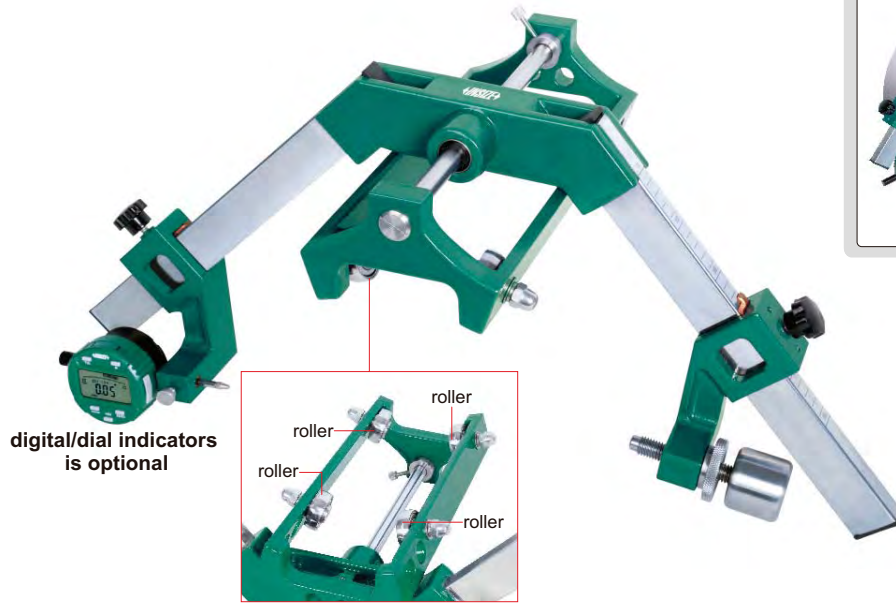

2715-350

application



8

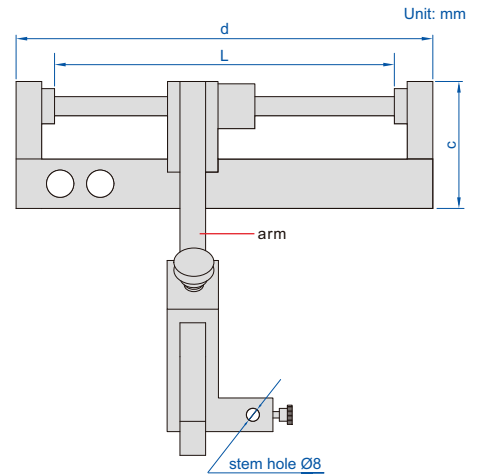
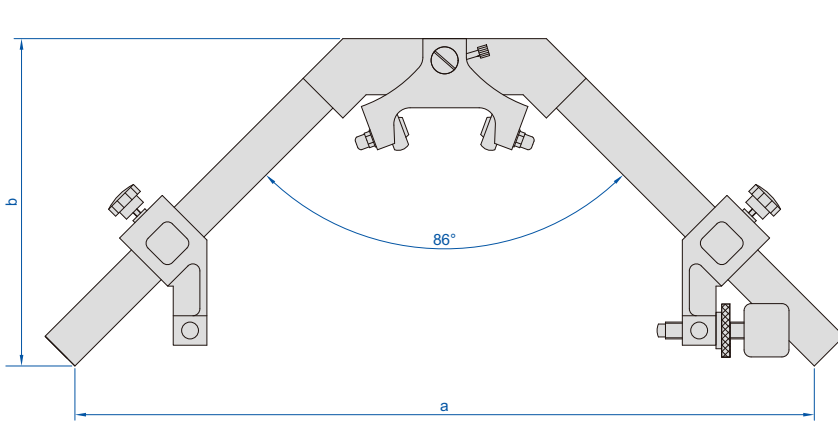

- Measurement of diameter variation, convexity, concavity, taper and other parameters
- Continuous measurement in the axis direction
- Four rollers are included
- Optional accessory: 0.01mm or 0.001mm graduation digital/dial indicators

(mm)

Code	Range (diameter)	Accuracy	Repeatability	Arm moving range (L)	a	b	c	d	Weight
2715-350	100-350mm/4-14"	0.01mm	3µm	200mm	500	230	80	260	4kg
2715-500	200-500mm/8-20"	0.01mm	3µm	151mm	630	260	95	260	5kg
2715-700	300-700mm/12-28"	0.01mm	3µm	197mm	910	372	112	320	6.5kg
2715-1000	500-1000mm/20-40"	0.01mm	3µm	190mm	1170	460	120	320	8kg
2715-1600	800-1600mm/32-64"	0.02mm	6µm	202mm	1860	690	180	320	12.5kg
2715-2000	1400-2000mm/56-80"	0.02mm	6µm	232mm	2156	860	210	350	18.5kg

OUTSIDE DIAMETER MEASURING INSTRUMENTS

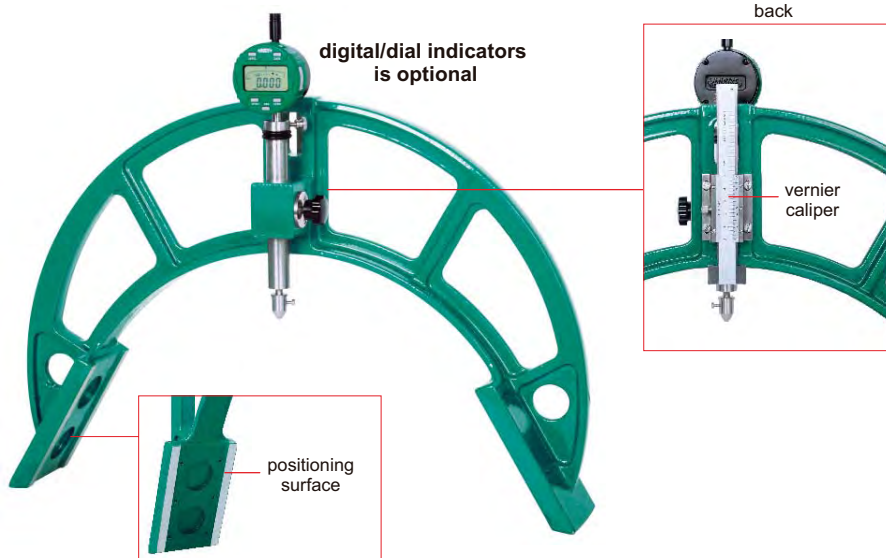

2716-500

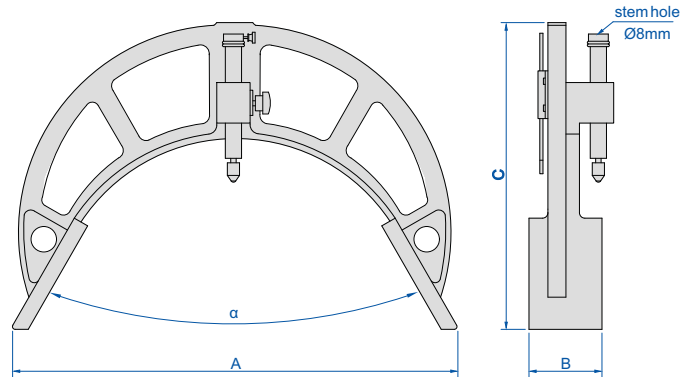

- Comparison measurement by digital/dial indicators. Need standard workpieces to set zero. Measure diameter/convex/concave/taper/roundness and other parameters, can also measure the wear and surface scratch of the workpieces
- Diameter measurement by vernier caliper, graduation: 0.02mm
- The frame is made of aluminum magnesium alloy with light weight and high strength
- Optional accessory: 0.01mm or 0.001mm digital/dial indicators

(mm)

Code	Range (diameter)	Repeatability (by digital/dial indicators)	Accuracy (by vernier caliper)	α	A	B	C	Weight
2716-60	18-60	0.01mm	0.04mm	60°	140	60	160	1kg
2716-120	60-120	0.01mm	0.04mm	60°	166	65	162	1.5kg
2716-200	120-200	0.01mm	0.04mm	60°	225	70	228	2kg
2716-300	200-300	0.01mm	0.04mm	60°	330	80	262	2.5kg
2716-400	300-400	0.01mm	0.04mm	60°	405	80	303	4kg
2716-500	400-500	0.01mm	0.04mm	60°	494	80	340	5kg
2716-600	500-600	0.01mm	0.04mm	60°	594	80	398	6kg
2716-700	600-700	0.01mm	0.04mm	60°	685	80	446	7.5kg
2716-800	700-800	0.01mm	0.04mm	60°	772	80	479	9kg
2716-900	800-900	0.01mm	0.04mm	60°	860	80	520	10kg
2716-1000	900-1000	0.01mm	0.04mm	60°	950	80	560	11.5kg
2716-1100	1000-1100	0.01mm	0.04mm	60°	1035	90	575	13kg
2716-1200	1000-1200	0.01mm	0.08mm	83.62°	960	100	460	12kg
2716-1300	1100-1300	0.01mm	0.08mm	83.62°	1000	100	485	13.5kg
2716-1400	1200-1400	0.01mm	0.08mm	83.62°	1100	100	512	15kg
2716-1600	1400-1600	0.01mm	0.08mm	83.62°	1260	100	540	17kg
2716-1800	1600-1800	0.01mm	0.08mm	83.62°	1460	100	570	19kg
2716-2000	1800-2000	0.01mm	0.08mm	83.62°	1645	100	605	21kg

DIGITAL RADIUS GAGES



DATA OUTPUT



2188-55



2188-233



2188-143



2188-323

- Measure radius of external arc, arc angle of measured surface should be larger than 60°
- Display radius value, no need to calculate
- Button function: on/off, zero, data preset, inch/mm
- Keep preset data in memory after restart
- CR2032 battery, automatic power off (time is adjustable)
- Data output
- Stainless steel base
- Optional accessory: setting standards, data output cable (code 7315-50M page 5, 7302-40M page 13)

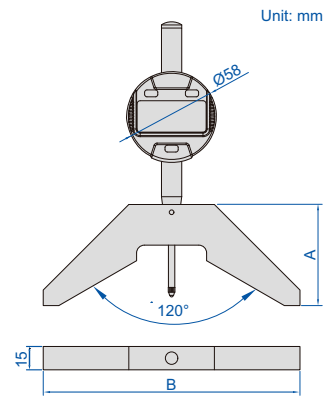
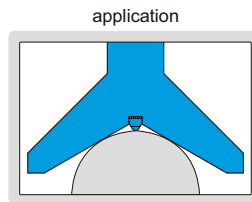

Code	Range (radius)	Resolution	Accuracy	A	B
2188-55	4-53mm/0.16-2.09"	0.01mm/0.0005"	±0.02mm	40mm	65mm
2188-143	48-143mm/1.89-5.63"	0.01mm/0.0005"	±0.03mm	65mm	165mm
2188-233	138-233mm/5.43-9.17"	0.01mm/0.0005"	±0.03mm	85mm	255mm
2188-323	228-323mm/8.98-12.72"	0.01mm/0.0005"	±0.04mm	95mm	345mm

Setting standards

Code	Setting standards	Remark
4110-10D00	setting standard for 2188-55	included
2188-P143	setting standard for 2188-143	optional
2188-P233	setting standard for 2188-233	optional
2188-P323	setting standard for 2188-323	optional



2188-P143

setting standard application



DIGITAL RADIUS GAGE (LOW ACCURACY)

DATA OUTPUT



2183

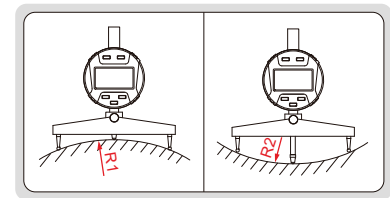
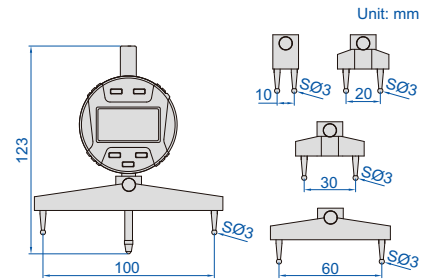

- Resolution: 0.01mm/0.001"
- Buttons: on/off, hold, mm/inch, s (select jaws), zero
- Measure radius of internal or external arcs
- Display can be rotated by 320°
- Supplied with 5 jaws for different sizes of arc
- Data output
- Battery CR2032, automatic power off (time is adjustable)
- Optional accessory: data output cable (code 7315-2183, 7302-2183)

Code	Range of external radius (R1)	Range of internal radius (R2)	Accuracy (mm)
2183	5-910mm/0.2-35.83"	7-910mm/0.3-35.83"	±0.01R*

*R is the radius to be measured. For example, radius is 100mm, the accuracy is ±0.01×100=±1mm

DIGITAL RADIUS GAGE

DATA OUTPUT



2511

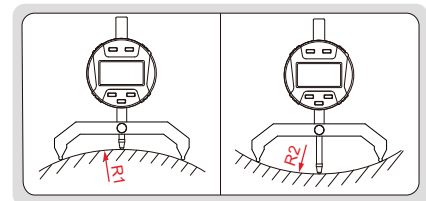
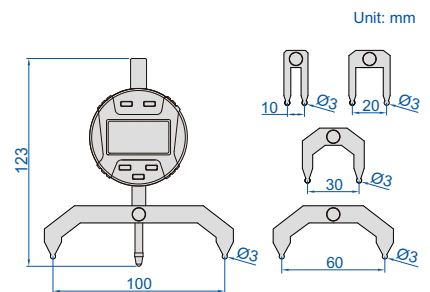

- Resolution: 0.01mm/0.001"
- Buttons: on/off, hold, mm/inch, s (select jaws), zero
- Measure radius of internal or external arcs
- Cylindrical measuring jaws, self-positioning
- Display can be rotated by 320°
- Supplied with 5 jaws for different sizes of arc
- Data output
- Battery CR2032, automatic power off (time is adjustable)
- Optional accessory: data output cable (code 7315-2183, 7302-2183)



Code	Range of external radius (R1)	Range of internal radius (R2)	Accuracy (mm)
2511	5-910mm/0.2-35.83"	7-910mm/0.3-35.83"	±0.005R*

*R is the radius to be measured. For example, radius is 100mm, the accuracy is ±0.005×100=±0.5mm

LARGE RANGE DIGITAL RADIUS GAGE

DATA OUTPUT

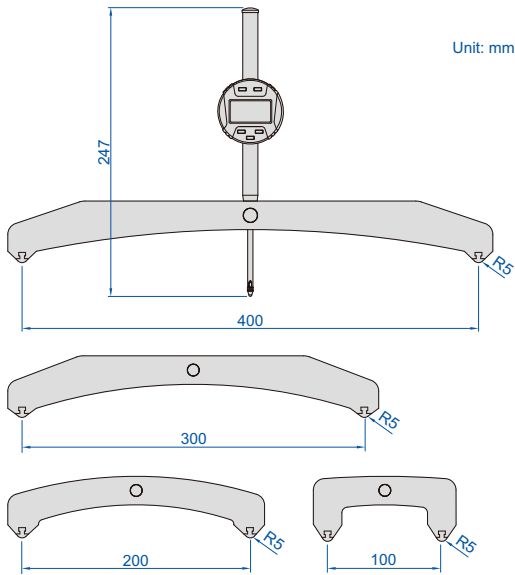

2197

- Measure radius of internal or external arcs
- Resolution: 0.01mm/0.001"
- Buttons: on/off, hold, mm/inch, s (select jaws), zero
- Display can be rotated by 320°
- Supplied with 4 jaws for different sizes of arc
- Battery CR2032, automatic power off (time is adjustable)
- Data output
- Optional accessory: data output cable (code 7315-2183, 7302-2183)

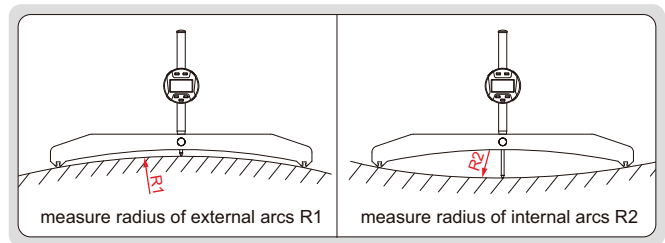

Code	Range of external radius (R1)	Range of internal radius (R2)	Accuracy (mm)
2197	100-15000mm/4-590"	100-15000mm/4-590"	±0.005R*



*R is the radius to be measured. For example, radius is 100mm, the accuracy is ±0.005x100=±0.5mm

DIGITAL ARC RADIUS CALIPERS

DATA OUTPUT

- Non waterproof
- Measure the radius of arc less than half round
- Resolution: 0.01mm/0.0005"
- Buttons: on/off, zero, mm/inch
- Automatic power off, move the digital unit to turn on power
- Battery CR2032
- Data output
- Made of stainless steel



1189-200B

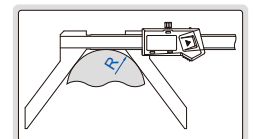

With data interface
(data output cable code 7315-21 page 4, 7302-21 page 12, optional)

Code	Range (R)	Accuracy	L	c	d
1189-150B	5-150mm/0.2-6"	±0.05mm	263mm	16mm	65mm
1189-200B	5-200mm/0.2-8"	±0.07mm	313mm	16mm	85mm

Built-in wireless (receiver code 7315-2/3/6/7/8/9 is required)

Code	Range (R)	Accuracy	L	c	d
1189-150BWL	5-150mm/0.2-6"	±0.05mm	263mm	16mm	65mm
1189-200BWL	5-200mm/0.2-8"	±0.07mm	313mm	16mm	85mm

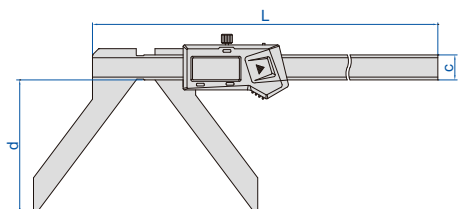

DIGITAL RADIUS CALIPERS

DATA
OUTPUT

ATTENTION: THE ACTUAL RADIUS
IS 2.414 TIMES OF THE READING



1501-25



1501-10

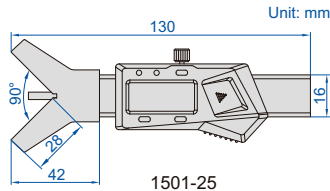

1501-25

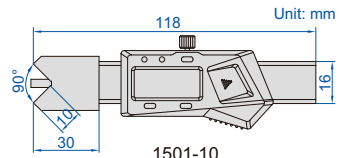

1501-10

- Non waterproof
- Measure radius of external arc, arc angle of measured surface should be larger than 90°
- Resolution: 0.01mm/0.0005"
- Buttons: on/off, set, mm/inch, preset (+, -)
- Automatic power off, move the digital unit to turn on power
- Battery CR2032
- Data output
- Made of stainless steel
- Supplied with pin gage for zero setting

1501-10 can measure
small workpieces or
workpieces with steps

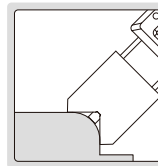

application

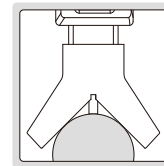

pin gage
(included)



Code	Range (radius)	Accuracy
1501-25	2-25mm/0.079-1"	±0.05mm
1501-10	2-10mm/0.079-0.394"	±0.05mm

RADIUS GAGES

REFER TO PAGE 370 FOR DETAILS



4801-17



4802-31



RADIUS GAGE SET
4804-26



Digital Chamfer Gages
Page 194



Chamfer Gages
Page 195



Digital Chamfer Gages
Page 195

CHAMFER GAGES



1267-6

- Measure 30°/45°/60° chamfer dimension
- Graduation: 0.02mm
- Made of stainless steel
- Satin chrome plated reading surface

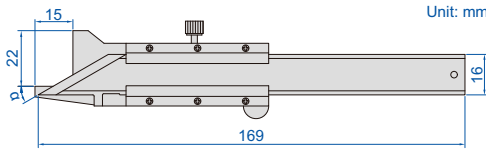

measure chamfer dimension

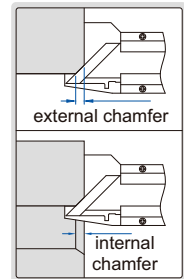

for internal chamfer measurement, diameter should be larger than ØD

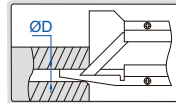

Code	Range	Accuracy	Chamfer (α)	ØD
1267-6	0-10mm	±0.06mm	45°	7mm
1267-63	0-10mm	±0.06mm	30°	8mm
1267-66	0-10mm	±0.06mm	60°	7mm

DIGITAL CHAMFER GAGES

DATA OUTPUT



1180-6

- Non waterproof
- Measure 15°/20°/30°/45°/60° chamfer dimension
- Resolution: 0.01mm/0.0005"
- Buttons: on/off, zero, mm/inch
- Automatic power off, move the digital unit to turn on power
- Battery CR2032
- Data output
- Made of stainless steel

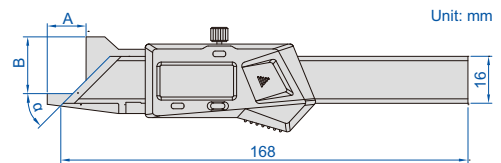

for internal chamfer measurement, diameter should be larger than ØD

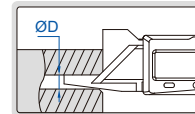

measure chamfer dimension

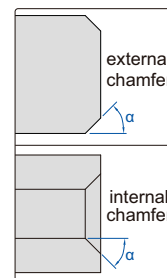
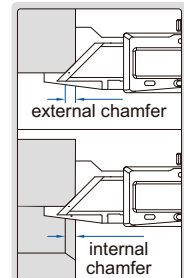

With data interface (data output cable code 7315-21 page 4, 7302-21 page 12, optional)

Code	Range	Accuracy	Chamfer (α)	A	B	ØD
1180-6	0-10mm/0-0.39"	±0.06mm	45°	15mm	22mm	7mm
1180-61	0-10mm/0-0.39"	±0.06mm	15°	33mm	20mm	11mm
1180-62	0-10mm/0-0.39"	±0.06mm	20°	33mm	20mm	11mm
1180-63	0-10mm/0-0.39"	±0.06mm	30°	15mm	22mm	8mm
1180-66	0-10mm/0-0.39"	±0.06mm	60°	14mm	21mm	7mm

Built-in wireless (receiver code 7315-2/3/6/7/8/9 is required)

Code	Range	Accuracy	Chamfer (α)	A	B	ØD
1180-6WL	0-10mm/0-0.39"	±0.06mm	45°	15mm	22mm	7mm
1180-61WL	0-10mm/0-0.39"	±0.06mm	15°	33mm	20mm	11mm
1180-62WL	0-10mm/0-0.39"	±0.06mm	20°	33mm	20mm	11mm
1180-63WL	0-10mm/0-0.39"	±0.06mm	30°	15mm	22mm	8mm
1180-66WL	0-10mm/0-0.39"	±0.06mm	60°	14mm	21mm	7mm

CHAMFER GAGE

for internal chamfer measurement, diameter should be larger than ØD

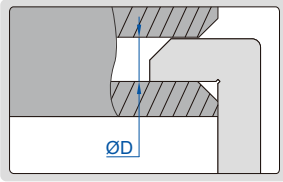

4844-1

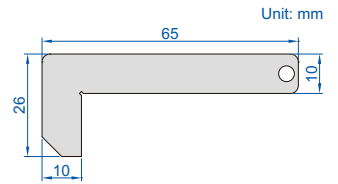

- To measure internal and external chamfers
- Made of stainless steel

Code	Graduation	Accuracy	ØD
4844-1	0.5mm	±0.25mm	11mm

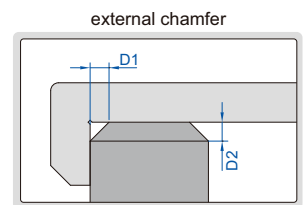
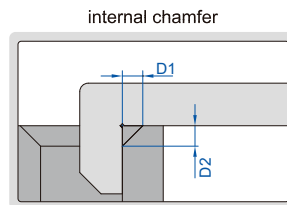

ATTENTION: THE ACTUAL LENGTH IS 1.1414 TIMES OF THE READING

ATTENTION: CHAMFER OF HOLES CANNOT BE MEASURED

DATA OUTPUT

DIGITAL CHAMFER GAGES



1537-20

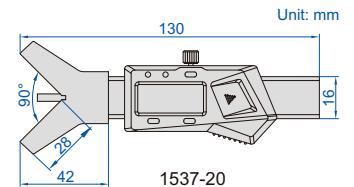

- Non waterproof
- Measure 45° chamfer length
- Resolution: 0.01mm/0.0005"
- Buttons: on/off, set, mm/inch, preset (+, -)
- Automatic power off, move the digital unit to turn on power
- Battery CR2032
- Data output
- Made of stainless steel
- Supplied with pin gage for zero setting



1537-8

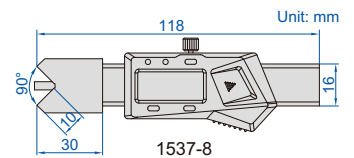

Code	Range	Accuracy
1537-20	0-20mm/0-0.787"	±0.05mm
1537-8	0-8mm/0-0.315"	±0.05mm

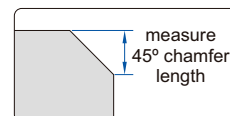

pin gage (included)



1537-8 can measure small workpieces or workpieces with steps

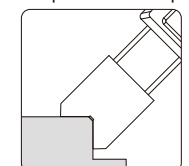

10

INDICATORS, LINEAR GAGES, DIAL INDICATOR STANDS



Dial Test Indicators
Page 197-199



Styli For Dial Test Indicators
Page 199



Digital Indicators
Page 200-212



Zeroing Foot Switches
Page 209



High Precision Digital Indicators
Page 213



Dial Indicators
Page 213-218



Points
Page 219-221



Spindle Lift Knobs
Page 222



Shaft Sleeves
Page 222



Backs
Page 222-223



Dial Indicator Testers
Page 224



Optical Grating Linear Gages And Display Units
Page 225-228



Capacitance Type Linear Gages And Display Units
Page 228-230



Dial Test Indicator Holders
Page 231-232



Magnetic Stands
Page 233-238



Dial Indicator Stands (non-magnetic)
Page 238-239



Dial Indicator Stands
Page 240-246



Digital Height Gages
Page 246

JEWELLED BEARING

INSPECTION CERTIFICATE

DIAL TEST INDICATORS

POPULAR MODEL

- Meet DIN2270 (except **2380-02, 2381-02, 2381-021**)
- Jeweled bearing
- Carbide contact point
- Two measuring directions
- Anti magnetic body
- Supplied with two clamps: diameter Ø4mm and Ø8mm
- Optional accessory: styli (page 199)

clamp (included)

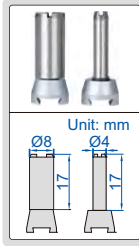

2380-08

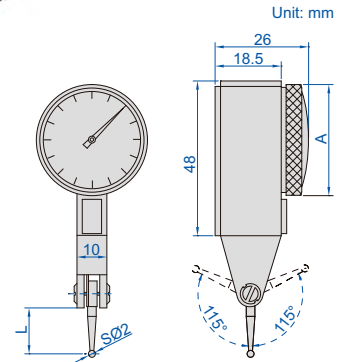

(mm)

Code	Range	Graduation	Accuracy	Hysteresis	Dial reading	A	L
2380-08*	0.8mm	0.01mm	13µm	3µm	0-40-0	Ø30	13.5
2381-08*	0.8mm	0.01mm	13µm	3µm	0-40-0	Ø37	13.5
2380-02*	0.2mm	0.002mm	6µm	2µm	0-100-0	Ø30	12.5
2381-02*	0.2mm	0.002mm	6µm	2µm	0-100-0	Ø37	12.5
2381-021*	0.2mm	0.001mm	6µm	2µm	0-100-0	Ø37	12.5

*Supplied with manufacturer inspection certificate

10

JEWELLED BEARING

INSPECTION CERTIFICATE

INCH DIAL TEST INDICATORS

- Jeweled bearing
- Carbide contact point
- Two measuring directions
- Anti magnetic body
- Supplied with two clamps: 5/32" DIA and 3/8" DIA



2380-31

clamp (included)

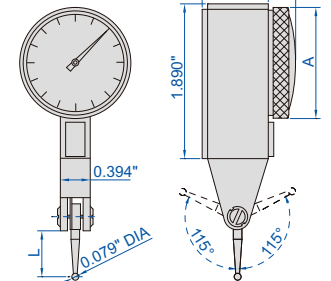
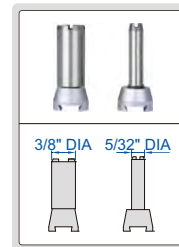

Code	Range	Graduation	Accuracy	Dial reading	A	L
2380-31*	0.03"	0.001"	±0.001"	0-15-0	1.181" DIA	0.50"
2380-35*	0.03"	0.0005"	±0.0005"	0-15-0	1.181" DIA	0.50"
2380-301*	0.008"	0.0001"	±0.0001"	0-40-0	1.181" DIA	0.563"
2381-31*	0.03"	0.001"	±0.001"	0-15-0	1.457" DIA	0.50"
2381-35*	0.03"	0.0005"	±0.0005"	0-15-0	1.457" DIA	0.50"
2381-301*	0.008"	0.0001"	±0.0001"	0-40-0	1.457" DIA	0.563"

*Supplied with manufacturer inspection certificate

JEWELLED BEARING

INSPECTION CERTIFICATE

LONG STYLUS DIAL TEST INDICATOR

- Meet DIN2270
- Jeweled bearing
- Carbide contact point
- Two measuring directions
- Anti magnetic body
- Supplied with two clamps: diameter Ø4mm and Ø8mm
- Optional accessory: styli (page 199)



2383-08A

clamp (included)

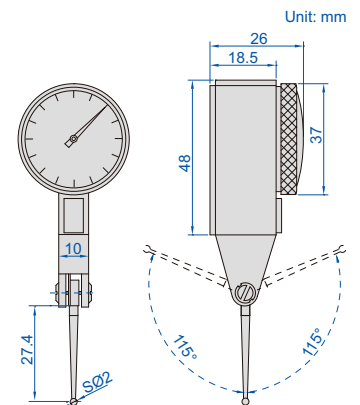
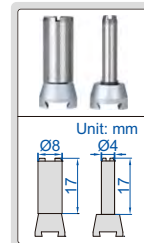

Code	Range	Graduation	Accuracy	Hysteresis	Dial reading
2383-08A*	0.8mm	0.01mm	13µm	3µm	0-40-0

*Supplied with manufacturer inspection certificate

VERTICAL TYPE DIAL TEST INDICATOR

- Meet DIN2270
- Jeweled bearing
- Carbide contact point
- Two measuring directions
- Anti magnetic body
- Supplied with two clamps: diameter $\varnothing 4\text{mm}$ and $\varnothing 8\text{mm}$
- Optional accessory: styli (page 199)

clamp (included)

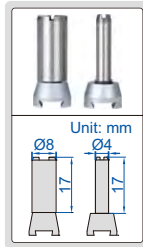

2398-08

INSPECTION CERTIFICATE

JEWELLED BEARING

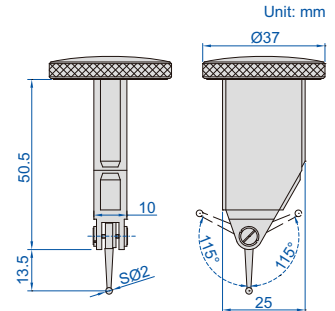

Code	Range	Graduation	Accuracy	Hysteresis	Dial reading
2398-08*	0.8mm	0.01mm	13 μm	3 μm	0-40-0

*Supplied with manufacturer inspection certificate

10

TILTED FACE TYPE DIAL TEST INDICATOR

- Meet DIN2270
- Jeweled bearing
- Carbide contact point
- Two measuring directions
- Anti magnetic body
- Supplied with two clamps: diameter $\varnothing 4\text{mm}$ and $\varnothing 8\text{mm}$
- Optional accessory: styli (page 199)



2399-08

INSPECTION CERTIFICATE

JEWELLED BEARING

clamp (included)

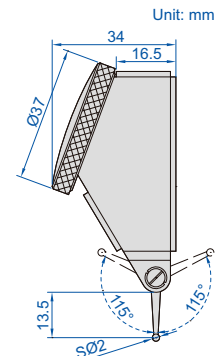
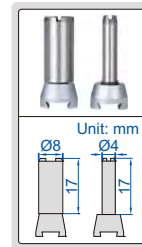

Code	Range	Graduation	Accuracy	Hysteresis	Dial reading
2399-08*	0.8mm	0.01mm	13 μm	3 μm	0-40-0

*Supplied with manufacturer inspection certificate

LARGE RANGE DIAL TEST INDICATOR

- Dial reading: 0-40-0
- Jeweled bearing
- Carbide contact point
- Two measuring directions
- Anti magnetic body
- Supplied with two clamps: diameter $\varnothing 4\text{mm}$ and $\varnothing 8\text{mm}$
- Optional accessory: styli (page 199)



2386-16A

INSPECTION CERTIFICATE

JEWELLED BEARING

clamp (included)

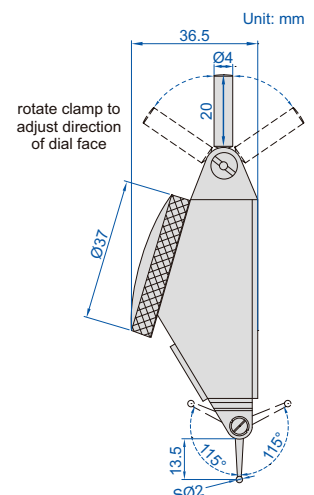
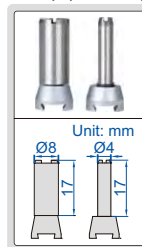

Code	Range	Graduation	Accuracy	Hysteresis
2386-16A*	1.6mm	0.01mm	25 μm	8 μm

*Supplied with manufacturer inspection certificate

JEWELLED BEARING

INSPECTION CERTIFICATE

LARGE RANGE VERTICAL TYPE DIAL TEST INDICATOR

- Dial Reading: 0-40-0
- Jeweled bearing
- Carbide contact point
- Two measuring directions
- Anti magnetic body
- Supplied with two clamps: diameter Ø4mm and Ø8mm
- Optional accessory: styli (page 199)

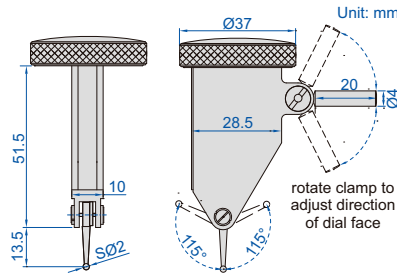

2480-16

clamp (included)

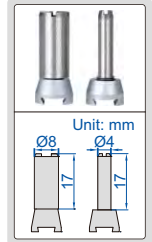

10

Code	Range	Graduation	Accuracy	Hysteresis
2480-16*	1.6mm	0.01mm	18µm	3µm

* Supplied with manufacturer inspection certificate

CLAMPS FOR DIAL TEST INDICATORS

Code	ØD
6298-1	Ø4mm
6298-2	Ø8mm



6298-1



6298-2

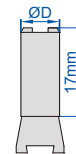

STYLI FOR DIAL TEST INDICATORS

Code	For dial test indicator	Material of contact point	L	D
6284-1	2380-08 2398-08 2381-08 2399-08	steel	13.5mm	SØ1mm
6284-31		ruby	13.5mm	SØ1mm
6284-3		carbide	13.5mm	SØ2mm
6284-4		ruby	13.5mm	SØ2mm
6284-8		carbide	13.5mm	SØ3mm
6284-21	2380-02 2381-02 2381-021	steel	12.5mm	SØ1mm
6284-22		carbide	12.5mm	SØ2mm
6284-24		ruby	12.5mm	SØ2mm
6284-23		carbide	12.5mm	SØ3mm
6284-61	2386-16A 2480-16	steel	13.5mm	SØ1mm
6284-62		carbide	13.5mm	SØ2mm
6284-63		ruby	13.5mm	SØ2mm
6284-64		carbide	13.5mm	SØ3mm
6284-81	2383-08A	steel	27.4mm	SØ1mm
6284-82		carbide	27.4mm	SØ2mm
6284-83		ruby	27.4mm	SØ2mm
6284-84		carbide	27.4mm	SØ3mm



6284-3

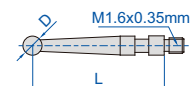

DIGITAL INDICATORS (STANDARD TYPE)

DATA OUTPUT

INSPECTION CERTIFICATE

POPULAR MODEL



2112-10



2112-251



2112-25P



2112-501

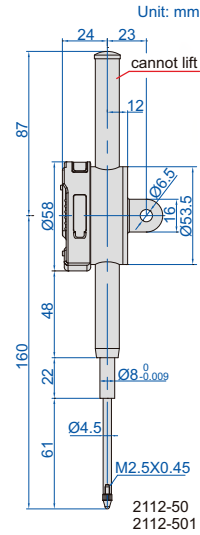
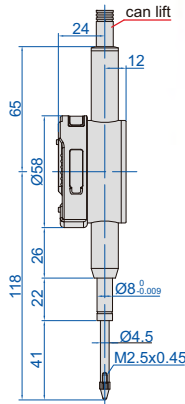
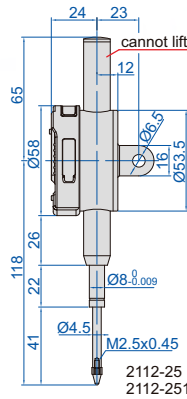
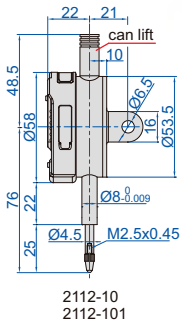

- Button function: on/off, inch/mm, zero, data preset, change measuring direction, absolute/incremental measurement
- Switchable high/low frequency measurement mode, high frequency mode is suitable for high speed moving of spindle and has large power consumption, low power consumption in low frequency mode
- Keep preset data in memory after restart
- CR2032 battery, automatic power off (time is adjustable)
- Data output
- Optional accessory: data output cable (code 7315-50M page 5, 7302-40M page 13, 7305-40M page 9), backs (page 222~223), contact points (page 219~221)

Resolution 0.001mm/0.00005"

Code	Range	Accuracy	Hysteresis	Maximum measuring force	Remark
2112-101F*	12.7mm/0.5"	5µm	2µm	1.5N	flat back
2112-251F*	25.4mm/1"	5µm	3µm	2.2N	flat back
2112-501F*	50.8mm/2"	6µm	3µm	2.5N	flat back
2112-101*	12.7mm/0.5"	5µm	2µm	1.5N	lug back
2112-251*	25.4mm/1"	5µm	3µm	2.2N	lug back
2112-501*	50.8mm/2"	6µm	3µm	2.5N	lug back
2112-251P*	25.4mm/1"	5µm	3µm	2.2N	flat back, with lift cap
2112-501P*	50.8mm/2"	6µm	3µm	2.5N	flat back, with lift cap

Resolution 0.01mm/0.0005"

Code	Range	Accuracy	Hysteresis	Maximum measuring force	Remark
2112-10F*	12.7mm/0.5"	20µm	10µm	1.5N	flat back
2112-25F*	25.4mm/1"	20µm	10µm	2.2N	flat back
2112-50F*	50.8mm/2"	30µm	10µm	2.5N	flat back
2112-10*	12.7mm/0.5"	20µm	10µm	1.5N	lug back
2112-25*	25.4mm/1"	20µm	10µm	2.2N	lug back
2112-50*	50.8mm/2"	30µm	10µm	2.5N	lug back
2112-25P*	25.4mm/1"	20µm	10µm	2.2N	flat back, with lift cap
2112-50P*	50.8mm/2"	30µm	10µm	2.5N	flat back, with lift cap

*Supplied with manufacturer inspection certificate

2112-251P/501P/25P/50P



spindle lift knob is included



DATA
OUTPUT

INSPECTION
CERTIFICATE

METRIC DIGITAL INDICATORS

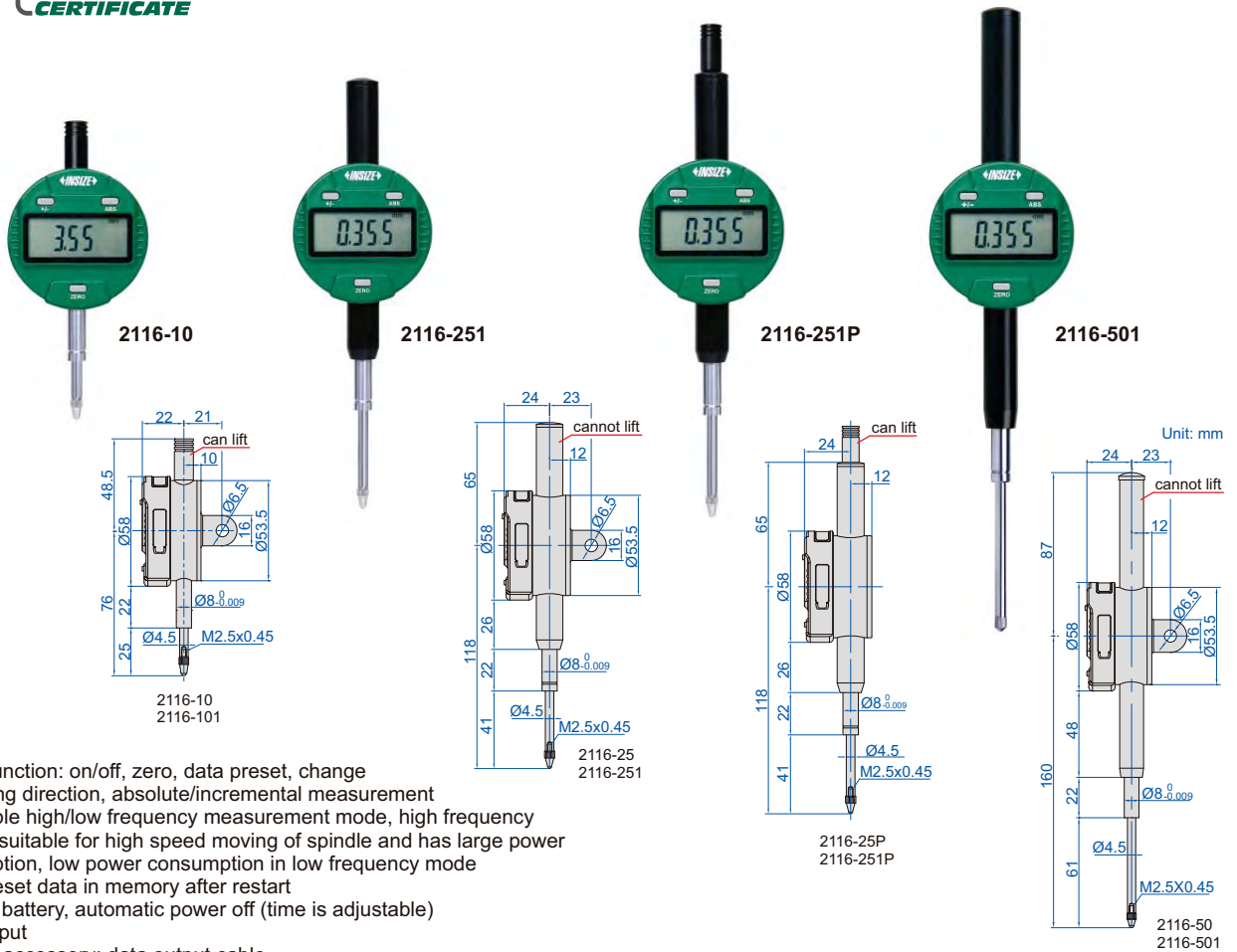

- Button function: on/off, zero, data preset, change measuring direction, absolute/incremental measurement
- Switchable high/low frequency measurement mode, high frequency mode is suitable for high speed moving of spindle and has large power consumption, low power consumption in low frequency mode
- Keep preset data in memory after restart
- CR2032 battery, automatic power off (time is adjustable)
- Data output
- Optional accessory: data output cable (code **7315-50M** page 5, **7302-40M** page 13, **7305-40M** page 9), backs (page 222~223), contact points (page 219~221)

Resolution 0.001mm

Code	Range	Accuracy	Hysteresis	Maximum measuring force	Remark
2116-101F*	12.7mm	5µm	2µm	1.5N	flat back
2116-251F*	25.4mm	5µm	3µm	2.2N	flat back
2116-501F*	50.8mm	6µm	3µm	2.5N	flat back
2116-101*	12.7mm	5µm	2µm	1.5N	lug back
2116-251*	25.4mm	5µm	3µm	2.2N	lug back
2116-501*	50.8mm	6µm	3µm	2.5N	lug back
2116-251P*	25.4mm	5µm	3µm	2.2N	flat back, with lift cap
2116-501P*	50.8mm	6µm	3µm	2.5N	flat back, with lift cap

Resolution 0.01mm

Code	Range	Accuracy	Hysteresis	Maximum measuring force	Remark
2116-10F*	12.7mm	20µm	10µm	1.5N	flat back
2116-25F*	25.4mm	20µm	10µm	2.2N	flat back
2116-50F*	50.8mm	30µm	10µm	2.5N	flat back
2116-10*	12.7mm	20µm	10µm	1.5N	lug back
2116-25*	25.4mm	20µm	10µm	2.2N	lug back
2116-50*	50.8mm	30µm	10µm	2.5N	lug back
2116-25P*	25.4mm	20µm	10µm	2.2N	flat back, with lift cap
2116-50P*	50.8mm	30µm	10µm	2.5N	flat back, with lift cap

*Supplied with manufacturer inspection certificate

2116-251P/501P/25P/50P



spindle lift knob is included



DIGITAL INDICATORS (ADVANCED TYPE)

INSPECTION CERTIFICATE

DATA OUTPUT



analog pointer

analog pointer

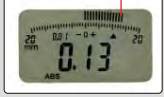

spindle lift knob is included

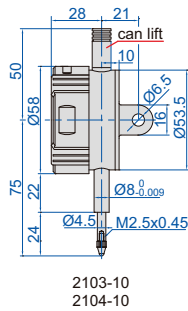

2103-10
2104-10

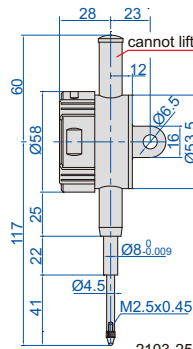

2103-25
2104-25

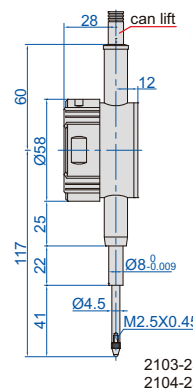

2103-25P
2104-25P

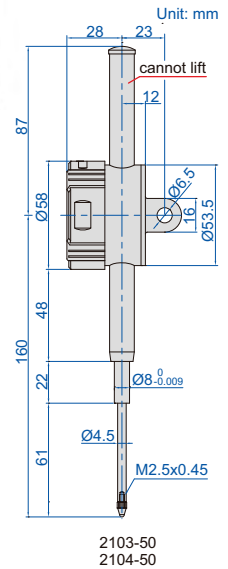

2103-50
2104-50

Unit: mm

max./min./TIR

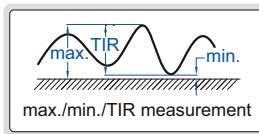

- Reading in digital and analog
- Display can be rotated by 320°
- Button function: tolerance Go and No-Go display, data preset, measuring direction change, max./min./TIR measurement, inch/metric conversion, absolute/incremental measurement
- Keep preset data and tolerance data in memory after restart
- CR2032 battery, automatic power off (time is adjustable), data output
- Optional accessory: data output cable (code **7315-50M** page 5, **7302-40M** page 13, **7305-40M** page 9), backs (page 222~223), contact points (page 219~221)

Resolution 0.001mm/0.00005"

Code	Range	Accuracy	Hysteresis	Maximum measuring force	Remark
2103-10F*	12.7mm/0.5"	5µm	2µm	1.5N	flat back
2103-25F*	25.4mm/1"	5µm	3µm	2.2N	flat back
2103-50F*	50.8mm/2"	6µm	3µm	2.5N	flat back
2103-10*	12.7mm/0.5"	5µm	2µm	1.5N	lug back
2103-25*	25.4mm/1"	5µm	3µm	2.2N	lug back
2103-50*	50.8mm/2"	6µm	3µm	2.5N	lug back
2103-25P*	25.4mm/1"	5µm	3µm	2.2N	flat back, with lift cap
2103-50P*	50.8mm/2"	6µm	3µm	2.5N	flat back, with lift cap

alarm when over tolerance

blink when over lower limit blink when over upper limit



Resolution 0.01mm/0.0005"

Code	Range	Accuracy	Hysteresis	Maximum measuring force	Remark
2104-10F*	12.7mm/0.5"	20µm	10µm	1.5N	flat back
2104-25F*	25.4mm/1"	20µm	10µm	2.2N	flat back
2104-50F*	50.8mm/2"	30µm	10µm	2.5N	flat back
2104-10*	12.7mm/0.5"	20µm	10µm	1.5N	lug back
2104-25*	25.4mm/1"	20µm	10µm	2.2N	lug back
2104-50*	50.8mm/2"	30µm	10µm	2.5N	lug back
2104-25P*	25.4mm/1"	20µm	10µm	2.2N	flat back, with lift cap
2104-50P*	50.8mm/2"	30µm	10µm	2.5N	flat back, with lift cap

2103-25P/50P
2104-25P/50P

pull lift cap to lift point



display can be rotated by 320°





DIGITAL INDICATORS (WITH TRANSMISSION BUTTON AND SIGNAL LIGHT)

DATA OUTPUT

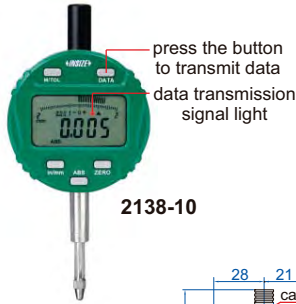

2138-10

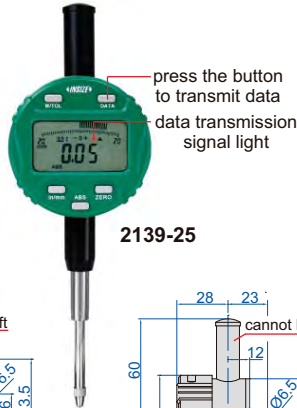

2139-25

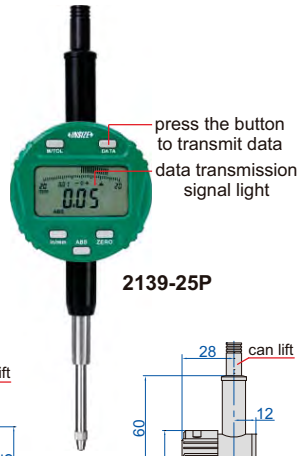

2139-25P

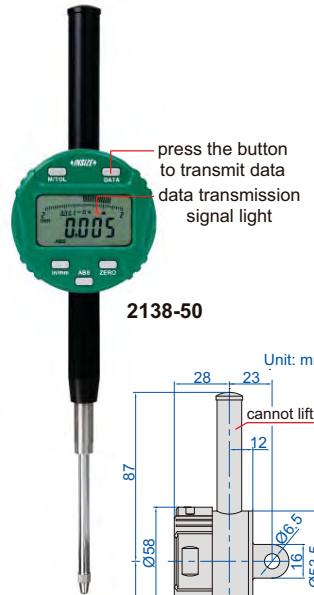

2138-50

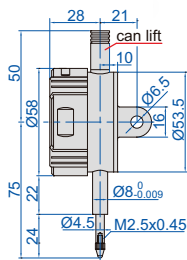

2138-10
2139-10

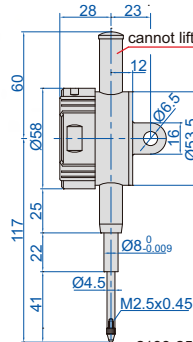

2138-25
2139-25

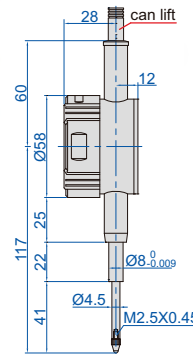

2138-25P
2139-25P

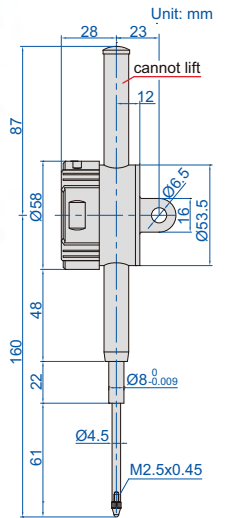

2138-50
2139-50

- Reading in digital and analog
- Display can be rotated by 320°
- Button function: on/off, zero, tolerance Go and No-Go display, data preset, measuring direction change, max./min./TIR measurement, inch/metric conversion, absolute/incremental measurement, data output
- Keep preset data and tolerance data in memory after restart
- CR2032 battery, automatic power off (time is adjustable)
- Data output
- Optional accessory: data output cable (flat back: code **7315-51** page 5, **7302-40M** page 13, **7305-40M** page 9; lug back: code **7315-50M** page 5, **7302-40M** page 13, **7305-40M** page 9), backs (page 222~223), contact points (page 219~221)

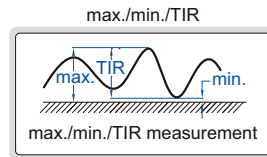

analog pointer

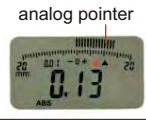

alarm when over tolerance

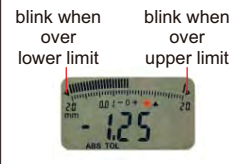

2138-25P/50P
2129-25P/50P



Resolution 0.001mm/0.00005"

Code	Range	Accuracy	Hysteresis	Maximum measuring force	Remark
2138-10F*	12.7mm/0.5"	5µm	2µm	1.5N	flat back
2138-25F*	25.4mm/1"	5µm	3µm	2.2N	flat back
2138-50F*	50.8mm/2"	6µm	3µm	2.5N	flat back
2138-10*	12.7mm/0.5"	5µm	2µm	1.5N	lug back
2138-25*	25.4mm/1"	5µm	3µm	2.2N	lug back
2138-50*	50.8mm/2"	6µm	3µm	2.5N	lug back
2138-25P*	25.4mm/1"	5µm	3µm	2.2N	flat back, with lift cap
2138-50P*	50.8mm/2"	6µm	3µm	2.5N	flat back, with lift cap

Resolution 0.01mm/0.0005"

Code	Range	Accuracy	Hysteresis	Maximum measuring force	Remark
2139-10F*	12.7mm/0.5"	20µm	10µm	1.5N	flat back
2139-25F*	25.4mm/1"	20µm	10µm	2.2N	flat back
2139-50F*	50.8mm/2"	30µm	10µm	2.5N	flat back
2139-10*	12.7mm/0.5"	20µm	10µm	1.5N	lug back
2139-25*	25.4mm/1"	20µm	10µm	2.2N	lug back
2139-50*	50.8mm/2"	30µm	10µm	2.5N	lug back
2139-25P*	25.4mm/1"	20µm	10µm	2.2N	flat back, with lift cap
2139-50P*	50.8mm/2"	30µm	10µm	2.5N	flat back, with lift cap

*Supplied with manufacturer inspection certificate



WATERPROOF DIGITAL INDICATORS

WATERPROOF

DATA OUTPUT

INSPECTION CERTIFICATE

alarm when over tolerance



spindle lift knob is included (except 2115-101/101F, 2115-10/10F)



max./min./TIR

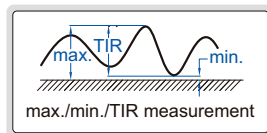

2115-10

2115-25

2115-50

- Dust/waterproof
- Button function: on/off, zero, mm/inch, data preset, tolerance, change measuring direction, max./min./TIR measurement, absolute/incremental measurement
- Keep preset data and tolerance data in memory after restart
- CR2032 battery, automatic power off
- Data output
- Optional accessory: data output cable (code 7315-50M page 5, 7302-40M page 13, 7305-40M page 9), backs (page 222~223), contact points (page 219~221)

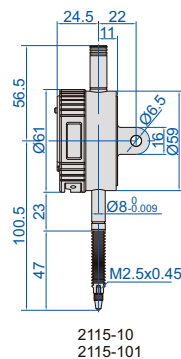

2115-10
2115-101

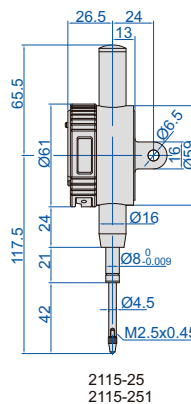

2115-25
2115-251

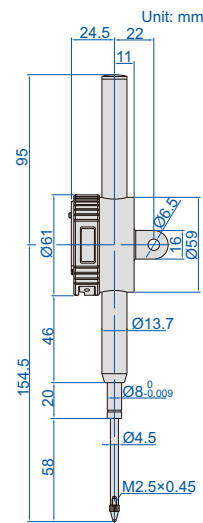

2115-50
2115-501

Resolution 0.001mm/0.00005"

Code	Range	Dust/waterproof	Accuracy	Hysteresis	Remark
2115-101*	12.7mm/0.5"	IP65	5µm	2µm	lug back
2115-251*	25.4mm/1"	IP54	5µm	3µm	lug back
2115-501*	50.8mm/2"	IP54	6µm	3µm	lug back
2115-101F*	12.7mm/0.5"	IP65	5µm	2µm	flat back
2115-251F*	25.4mm/1"	IP54	5µm	3µm	flat back
2115-501F*	50.8mm/2"	IP54	6µm	3µm	flat back

Resolution 0.01mm/0.0005"

Code	Range	Dust/waterproof	Accuracy	Hysteresis	Remark
2115-10*	12.7mm/0.5"	IP65	20µm	10µm	lug back
2115-25*	25.4mm/1"	IP54	20µm	10µm	lug back
2115-50*	50.8mm/2"	IP54	30µm	10µm	lug back
2115-10F*	12.7mm/0.5"	IP65	20µm	10µm	flat back
2115-25F*	25.4mm/1"	IP54	20µm	10µm	flat back
2115-50F*	50.8mm/2"	IP54	30µm	10µm	flat back

*Supplied with manufacturer inspection certificate



DATA OUTPUT

INSPECTION CERTIFICATE

ADJUSTABLE COEFFICIENT DIGITAL INDICATORS

10

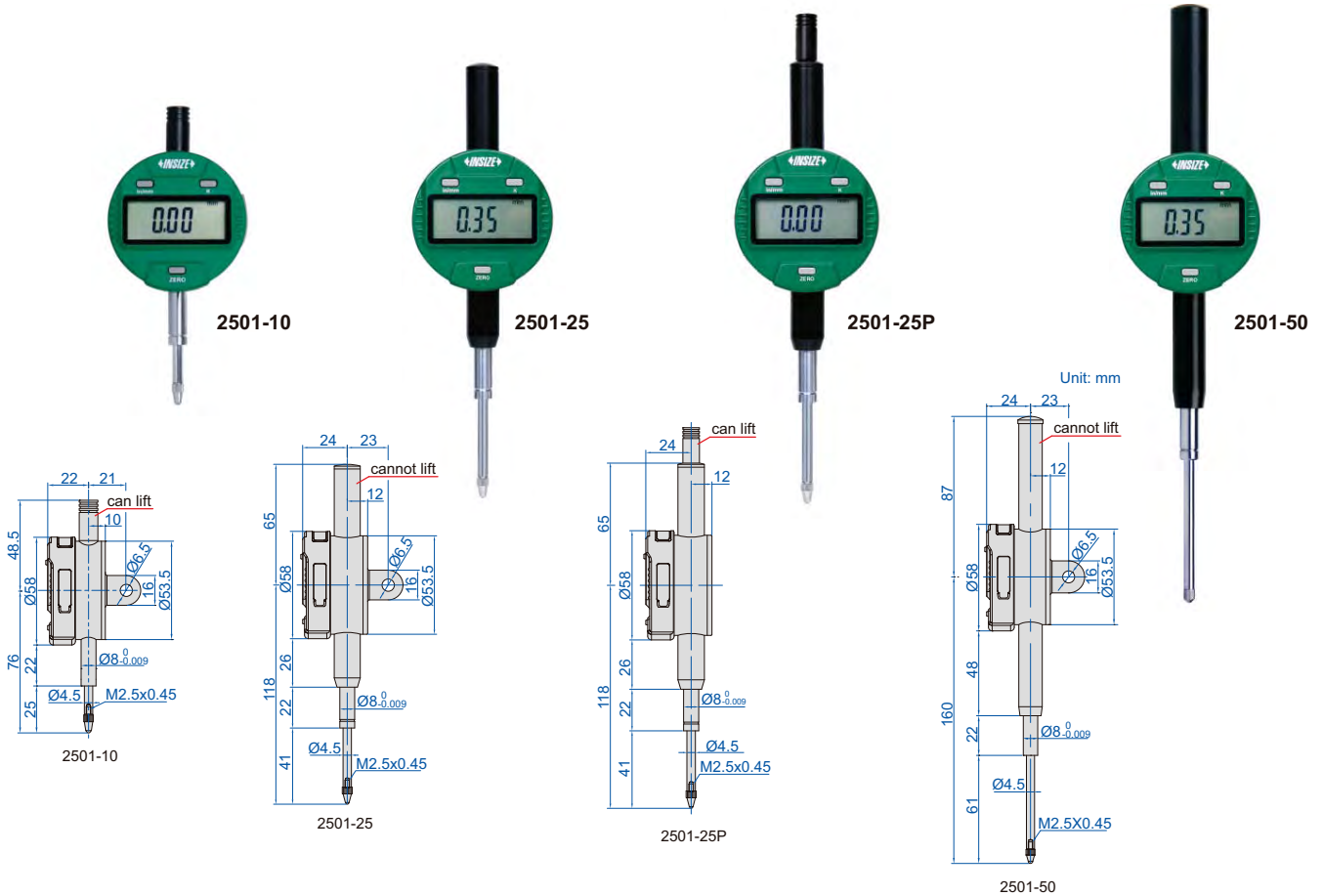

- DISPLAY READING = COEFFICIENT X SPINDLE MOVEMENT.
The coefficient can be adjusted from 0 to 9.9999.
For example, coefficient is 4.5562, spindle moves 3.60mm,
display reading is 4.5562 x 3.60=16.40mm
- Button function: on/off, zero, data preset, inch/mm, coefficient set, measuring direction change
- Switchable high/low frequency measurement mode, high frequency mode is suitable for high speed moving of spindle and has large power consumption, low power consumption in low frequency mode
- Keep preset data in memory after restart
- CR2032 battery, automatic power off (time is adjustable)
- Data output
- Optional accessory: data output cable (code **7315-50M** page 5, **7302-40M** page 13, **7305-40M** page 9), backs (page 222~223), contact points (page 219~221)

2501-25P/50P



spindle lift knob is included



Resolution 0.01mm/0.0005"

Code	Range	Accuracy	Hysteresis	Maximum measuring force	Remark
2501-10*	12.7mm/0.5"	20µm	10µm	1.5N	lug back
2501-25*	25.4mm/1"	20µm	10µm	2.2N	lug back
2501-50*	50.8mm/2"	30µm	10µm	2.5N	lug back
2501-10F*	12.7mm/0.5"	20µm	10µm	1.5N	flat back
2501-25F*	25.4mm/1"	20µm	10µm	2.2N	flat back
2501-50F*	50.8mm/2"	30µm	10µm	2.5N	flat back
2501-25P*	25.4mm/1"	20µm	10µm	2.2N	flat back, with lift cap
2501-50P*	50.8mm/2"	30µm	10µm	2.5N	flat back, with lift cap

*Supplied with manufacturer inspection certificate

DIGITAL INDICATORS FOR BORE GAGES (WITH TRANSMISSION BUTTON AND SIGNAL LIGHT)



THE ORIGINAL DATA
REMAINS AFTER POWER OFF

DATA
OUTPUT



2108-10F

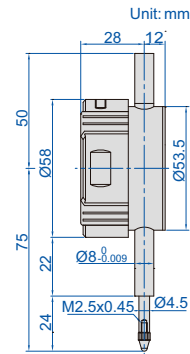

- Specially designed for bore gages
- The minimum value tracking function can find the diameter automatically
- Read the diameter directly, after inputting the size of setting ring
- Reading in digital and analog
- Display can be rotated by 320°
- Button function: on/off, minimum value tracking, calibration, data preset, inch/metric conversion
- Data remains after power off, no need to recalibrate after power on
- CR2032 battery, automatic power off (time is adjustable)
- Data output
- Optional accessory: data output cable (code 7315-51 page 5, 7302-40M page 13, 7305-40M page 9), backs (page 222~223), contact points (page 219~221), spindle lift knob (code 7332)

analog pointer



read the diameter directly, after inputting the size of setting ring.



the minimum value tracking function can find the diameter automatically.



Code	Range	Resolution	Accuracy	Hysteresis	Remark
2108-10F *	12.7mm/0.5"	0.002mm/0.0001" (can switch to: 0.01mm/0.0005")	20µm	10µm	flat back
2108-101F *	12.7mm/0.5"	0.001mm/0.00005"	5µm	2µm	flat back

*Supplied with manufacturer inspection certificate

WATERPROOF DIGITAL INDICATORS FOR BORE GAGES

IP54
WATERPROOF

DATA
OUTPUT

THE ORIGINAL DATA
REMAINS AFTER POWER OFF



- Specially designed for bore gages
- The minimum value tracking function can find the diameter automatically
- Read the diameter directly, after inputting the size of setting ring
- Button function: on/off, minimum value tracking, calibration, data preset, inch/metric conversion
- Data remains after power off, no need to recalibrate after power on
- CR2032 battery, automatic power off (time is adjustable)
- Data output
- Optional accessory: data output cable (code 7315-50M page 5, 7302-40M page 13, 7305-40M page 9), backs (page 222~223), contact points (page 219~221), spindle lift knob (code 7332)



2137-10F

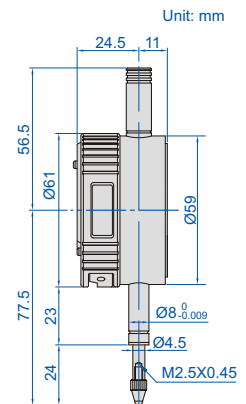

read the diameter directly, after inputting the size of setting ring.



the minimum value tracking function can find the diameter automatically.



Code	Range	Resolution	Accuracy	Hysteresis	Remark
2137-10F *	12.7mm/0.5"	0.002mm/0.0001" (can switch to: 0.01mm/0.0005")	20µm	10µm	flat back
2137-101F *	12.7mm/0.5"	0.001mm/0.00005"	5µm	2µm	flat back

*Supplied with manufacturer inspection certificate

DATA
OUTPUT

INSPECTION
CERTIFICATE

DIGITAL INDICATORS WITH LIFTING LEVER



2109-10

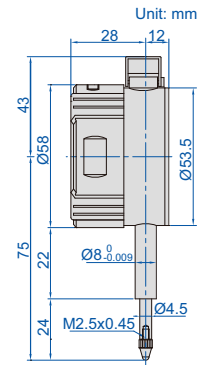

- Reading in digital and analog
- Display can be rotated by 320°
- Button function: tolerance Go and No-Go display, data preset, measuring direction change, max./min./TIR measurement, inch/metric conversion, absolute/incremental measurement
- Keep preset data and tolerance data in memory after restart
- CR2032 battery, automatic power off (time is adjustable)
- Data output
- Optional accessory: data output cable (code **7315-50M** page 5, **7302-40M** page 13, **7305-40M** page 9), backs (page 222~223), contact points (page 219~221)

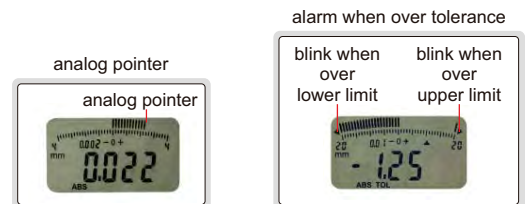

10

Code	Range	Resolution	Accuracy	Hysteresis	Remark
2109-10*	10mm/0.4"	0.01mm/0.0005"	20µm	10µm	flat back
2109-101*	10mm/0.4"	0.001mm/0.00005"	5µm	2µm	flat back

*Supplied with manufacturer inspection certificate

DATA
OUTPUT

INSPECTION
CERTIFICATE

COMPACT DIGITAL INDICATORS

- Button function:
 - in/mm: short press for inch/metric conversion
long press to change measuring direction
 - ABS: short press for absolute/incremental measurement
long press to preset data
 - O/ON: short press to turn on when power is off
short press to set zero when power is on
long press to turn off
- Keep preset data in memory after restart
- CR1632 battery, automatic power off
- Data output
- Optional accessory: data output cable (code **7315-50M** page 5, **7302-40M** page 13, **7305-40M** page 9), contact points (page 219~221)



2114-51F

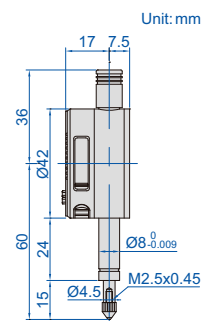

Code	Range	Resolution	Accuracy	Hysteresis	Remark
2114-5F*	5mm/0.2"	0.01mm/0.0005"	20µm	10µm	flat back
2114-51F*	5mm/0.2"	0.001mm/0.00005"	5µm	2µm	flat back

*Supplied with manufacturer inspection certificate

BACK PLUNGER TYPE DIGITAL INDICATORS



DATA OUTPUT



2118-10

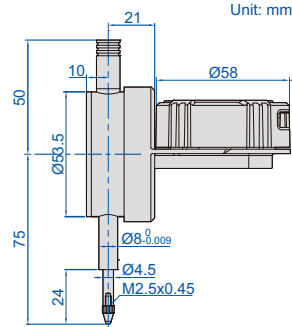

10

- Display can rotate 320°, and display direction is changeable
- Reading in digital and analog
- Button function: tolerance Go and No-Go display, data preset, measuring direction change, max./min./TIR measurement, inch/metric conversion, absolute/incremental measurement
- Keep preset data and tolerance data in memory after restart
- CR2032 battery, automatic power off (time is adjustable)
- Data output
- Optional accessory: data output cable (code 7315-50M page 5, 7302-40M page 13, 7305-40M page 9), backs (page 222~223), contact points (page 219~221)

spindle lift knob is included



max./min./TIR

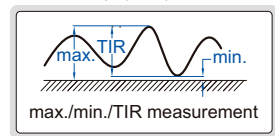

max./min./TIR measurement

alarm when over tolerance

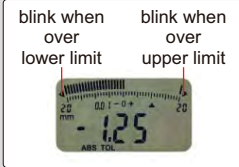

analog pointer



display direction is changeable

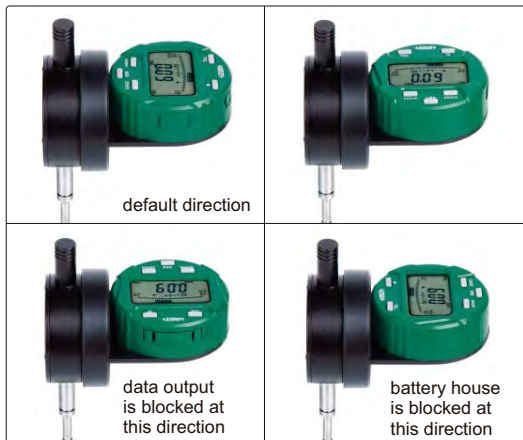

default direction

data output is blocked at this direction

battery house is blocked at this direction

display can rotate 320°



remark: to change above direction, 4 fixing screws on the back of display need to be removed first.

Code	Range	Resolution	Accuracy	Hysteresis	Remark
2118-10 *	12.7mm/0.5"	0.01mm/0.0005"	20µm	10µm	flat back
2118-101 *	12.7mm/0.5"	0.001mm/0.00005"	5µm	2µm	flat back

*Supplied with manufacturer inspection certificate

LARGE STROKE DIGITAL INDICATORS

DATA OUTPUT

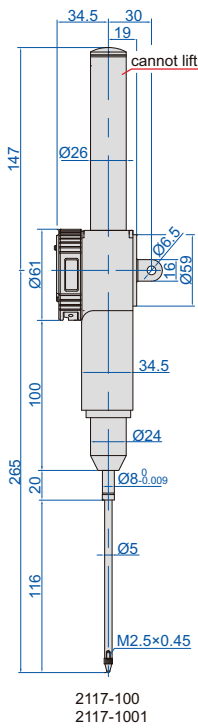

2117-100
2117-1001



2117-100

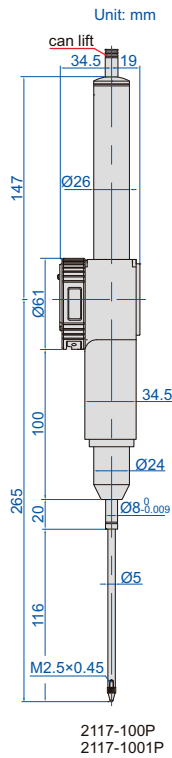

2117-100P
2117-1001P



2117-100P

Resolution 0.01mm/0.0005"

Code	Range	Accuracy	Hysteresis	Remark
2117-100	100mm/4"	30µm	10µm	lug back
2117-100P	100mm/4"	30µm	10µm	flat back, with lift cap

Resolution 0.001mm/0.00005"

Code	Range	Accuracy	Hysteresis	Remark
2117-1001	100mm/4"	9µm	3µm	lug back
2117-1001P	100mm/4"	9µm	3µm	flat back, with lift cap

- Button function: on/off, zero, mm/inch, data preset, tolerance, change measuring direction, max./min./TIR measurement, absolute/incremental measurement
- Keep preset data and tolerance data in memory after restart
- CR2032 battery, automatic power off
- Maximum measuring force: 3.2N
- Data output
- Optional accessory: data output cable (code 7315-50M page 5, 7302-40M page 13, 7305-40M page 9), backs (page 222~223), contact points (page 219~221)

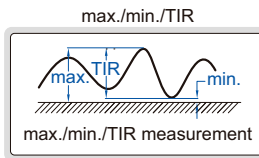

spindle lift knob is included



alarm when over tolerance

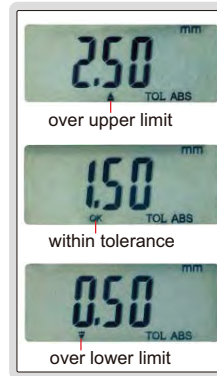

2117-100P/1001P



application

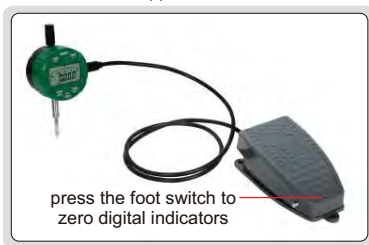

press the foot switch to zero digital indicators



7360-1M

ZEROING FOOT SWITCH

- For zeroing of digital indicators

Code	Description	Interface of digital indicators	Applicable products
7360-1M	zeroing foot switch with cable (length 2.5m)		for digital indicators

INDUCTIVE DIGITAL COMPARATOR

ATTENTION: RECHARGEABLE BATTERY,
FOR 12 HOURS CONTINUOUS WORKING

IP54
WATERPROOF

DATA
OUTPUT



2149-2

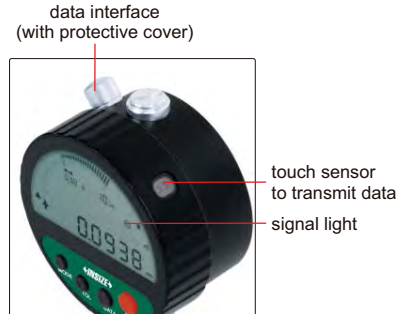

10

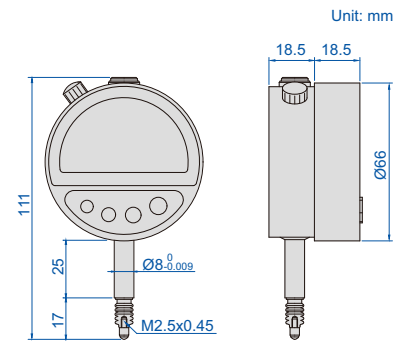
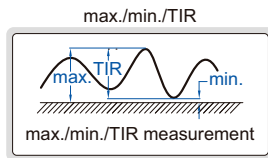

- Built-in wireless transmission
- IP54 dust/waterproof
- Reading in digital and analog
- Display can be rotated by 320°
- Can store 10 set parameters, and the parameter can be searched and recalled
- 999 groups value can be stored
- Touch sensor: use the sensor to transmit data, avoiding press the button to cause deformation of the dial indicator stand and affect the zero position
- Button function: on/off, zero, data hold, measuring direction change, inch/metric conversion, data preset, absolute/incremental measurement, max./min./TIR measurement, tolerance Go and No-Go display, data output, analog pointer resolution and range change, print data
- Power: rechargeable battery, for 12 hours continuous working
- Ruby probe
- Data output
- Optional accessory: wireless receiver (code **2149-RE**, transmission distance is 2 meters), printer (code **ISF-DF-PRINTER**)

Code	Range	Resolution	Accuracy	Hysteresis	Repeatability	Measuring force
2149-2	2mm/0.08"	0.1µm/0.000005"	0.5µm	0.2µm	0.3µm	0.8-1N

CONTINUOUS DATA COLLECTION CAN BE CUSTOMIZED (PRESS "DATA" BUTTON TO START CONTINUOUS COLLECTION, PRESS AGAIN TO STOP; COLLECTION FREQUENCY CAN BE CUSTOMIZED, THE FASTEST DATA COLLECTION IS 10PCS PER SECOND)

ATTENTION: RECHARGEABLE BATTERY, FOR 24 HOURS CONTINUOUS WORKING

ABSOLUTE ENCODER, THE ORIGINAL DATA REMAINS AFTER POWER OFF



WIRELESS HIGH PRECISION DIGITAL INDICATORS

alarm when over tolerance

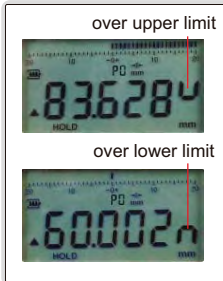

LINEAR BALL BEARINGS FOR TEN MILLION TIMES USE

analog pointer

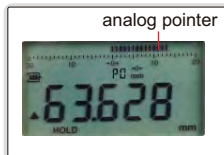

transmit data

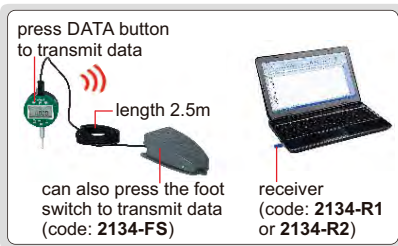

- Built-in wireless transmission, Zigbee single
- Linear ball bearings for ten million times use
- Absolute encoder, the original data remains after power off
- Reading in digital and analog
- Button function: data output, tolerance, data preset, data hold, measuring direction change, max./min./TIR, power off time, on/off, mm/inch, adjust resolution
- Power: rechargeable battery, for 24 hours continuous working
- Optional accessory: contact points (page 219-221), foot switch, code: **2134-FS**
wireless receiver, code: **2134-R1** (keyboard format) **2134-R2** (serial port format)

Standard precision

Carbide probe

Adjustable resolution: 0.0005mm/0.00002"
0.001mm/0.00005"
0.01mm/0.0005"

Code	Range	Accuracy	Hysteresis	A	B	C	ØD	Remark
2134-10*	12.7mm/0.5"	3µm	1.5µm	75.4mm	20.6mm	24.8mm	5mm	flat back
2134-10L*	12.7mm/0.5"	3µm	1.5µm	75.4mm	20.6mm	24.8mm	5mm	lug back
2134-25*	25.4mm/1"	3µm	1.5µm	109.5mm	38.5mm	41mm	5mm	flat back
2134-50*	50.8mm/2"	3µm	1.5µm	201mm	32mm	72mm	4.5mm	flat back

High precision

Ruby probe

Adjustable resolution: 0.0002mm/0.00001"
0.001mm/0.00005"
0.01mm/0.0005"

Code	Range	Accuracy	Hysteresis	A	B	C	ØD	Remark
2134-101*	12.7mm/0.5"	1.5µm	1µm	77.4	26	21.4	4	flat back
2134-101L*	12.7mm/0.5"	1.5µm	1µm	77.4	26	21.4	4	lug back
2134-251*	25.4mm/1"	1.8µm	1µm	116.1	42.5	44	4	flat back

* Supplied with manufacturer inspection certificate



2134-10



2134-25



2134-50

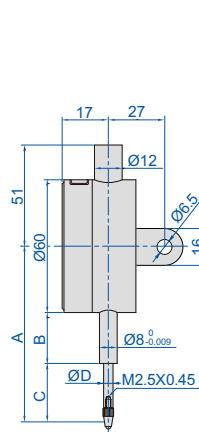

2134-10L
2134-101L

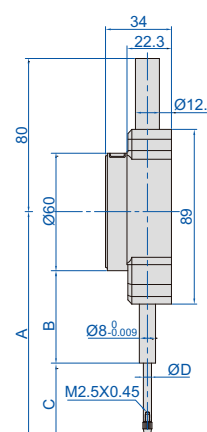

2134-25
2134-251

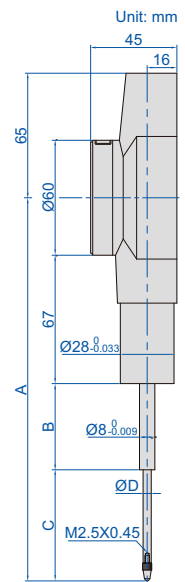

2134-50

spindle lift knob is included

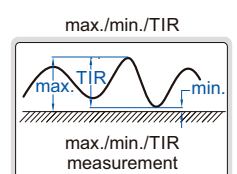

HIGH PRECISION DIGITAL INDICATORS

LINEAR BALL BEARINGS
FOR TEN MILLION TIMES USE

ABSOLUTE ENCODER, THE ORIGINAL
DATA REMAINS AFTER POWER OFF

DATA
OUTPUT

ATTENTION: RECHARGEABLE BATTERY,
FOR 24 HOURS CONTINUOUS WORKING



alarm when over tolerance

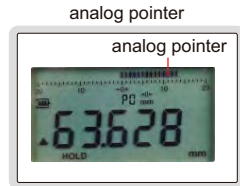
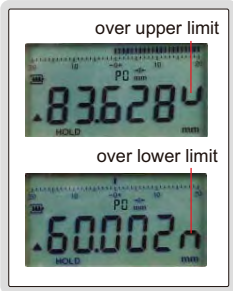

2133-10

2133-25

2133-50

- Linear ball bearings for ten million times use
- Absolute encoder, the original data remains after power off
- Reading in digital and analog
- Data output
- Button function: data output, tolerance, data preset, data hold, measuring direction change, max./min./TIR, power off time, on/off, mm/inch, adjust resolution
- Power: rechargeable battery, for 24 hours continuous working
- Optional accessory: contact points (page 219~221), wireless transmitter, code **7315-60** page 5 data output cable (keyboard format), code **7302-60** page 13 data output cable (serial port format), code **7305-G60** page 11 (cable length 3m, optional cable length maximum 15m; RS232 protocol, optional RS485 protocol)

Standard precision

Carbide probe

Adjustable resolution: 0.0005mm/0.00002"
0.001mm/0.00005"
0.01mm/0.0005"

Code	Range	Accuracy	Hysteresis	A	B	C	ØD	Remark
2133-10*	12.7mm/0.5"	3µm	1.5µm	75.4mm	20.6mm	24.8mm	5mm	flat back
2133-10L*	12.7mm/0.5"	3µm	1.5µm	75.4mm	20.6mm	24.8mm	5mm	lug back
2133-25*	25.4mm/1"	3µm	1.5µm	109.5mm	38.5mm	41mm	5mm	flat back
2133-50*	50.8mm/2"	3µm	1.5µm	201mm	32mm	72mm	4.5mm	flat back

High precision

Ruby probe

Adjustable resolution: 0.0002mm/0.00001"
0.001mm/0.00005"
0.01mm/0.0005"

Code	Range	Accuracy	Hysteresis	A	B	C	ØD	Remark
2133-101*	12.7mm/0.5"	1.5µm	1µm	77.4mm	26mm	21.4mm	4mm	flat back
2133-101L*	12.7mm/0.5"	1.5µm	1µm	77.4mm	26mm	21.4mm	4mm	lug back
2133-251*	25.4mm/1"	1.8µm	1µm	116.1mm	42.5mm	44mm	4mm	flat back

*Supplied with manufacturer inspection certificate

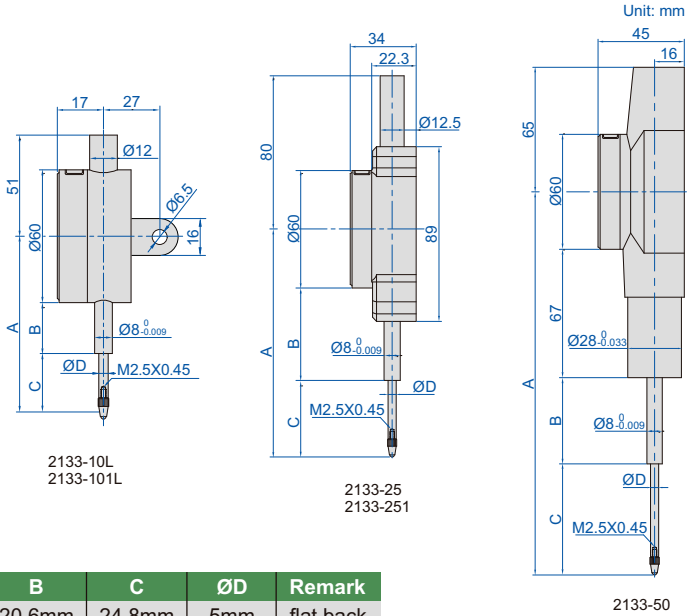

spindle lift knob is included



max./min./TIR

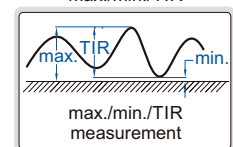



DATA OUTPUT

Ø28MM STEM SUITABLE FOR REINFORCED CLAMPING

ABSOLUTE ENCODER, THE ORIGINAL DATA REMAINS AFTER POWER OFF

LINEAR BALL BEARINGS FOR TEN MILLION TIMES USE

ATTENTION: RECHARGEABLE BATTERY, FOR 24 HOURS CONTINUOUS WORKING

HIGH PRECISION DIGITAL INDICATORS

- Linear ball bearings for ten million times use
- Ø28mm stem suitable for reinforced clamping
- Absolute encoder, the original data remains after power off
- Adjustable resolution: 0.0002mm/0.00001"
0.001mm/0.00005"
0.01mm/0.0005"
- Reading in digital and analog
- Button function: data output, tolerance, data preset, data hold, measuring direction change, max./min./TIR, power off time, on/off, mm/inch, adjust resolution
- Power: rechargeable battery, for 24 hours continuous working
- Ruby probe

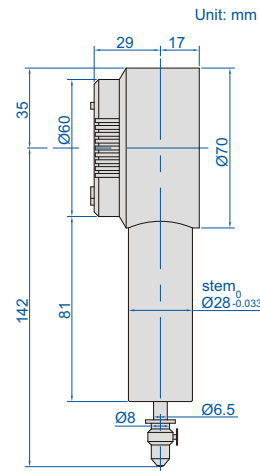

2140-6

alarm when over tolerance

over upper limit



over lower limit



analog pointer

analog pointer



With data interface

Optional accessory:

wireless transmitter, code **7315-60** page 5

data output cable (keyboard format), code **7302-60** page 13

data output cable (serial port format), code **7305-G60** page 11

(cable length 3m, optional cable length maximum 15m; RS232 protocol, optional RS485 protocol)

Code	Range	Accuracy	Hysteresis	Remark
2140-6	0-6mm/0-0.24"	1.6µm	0.8µm	flat back

max./min./TIR

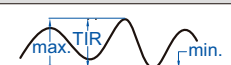

max./min./TIR measurement

Built-in wireless

Optional accessory:

wireless receiver (keyboard format, connect up to 15 digital indicators), code **2134-R1**

wireless receiver (serial port format, connect up to 15 digital indicators), code **2134-R2**

Code	Range	Accuracy	Hysteresis	Remark
2140-6WL*	0-6mm/0-0.24"	1.6µm	0.8µm	flat back

*Continuous data collection can be customized (press "DATA" button to start continuous collection, press again to stop; collection frequency can be customized, the fastest data collection is 10 pcs per second)

wireless receiver
2134-R1, 2134-R2 (optional)



JEWELLED BEARING

INSPECTION CERTIFICATE

PRECISION DIAL INDICATORS

- Graduation: 0.001mm
- Jeweled bearing
- Supplied with limit pointers and bezel clamp
- Optional accessory: backs (page 222~223), contact points (page 219~221)



2313-1A

(mm)

Code	Range	Accuracy	Hysteresis	Range/rev	Dial reading	Remark	A	B	C	D
2313-1FA *	1mm	5µm	2µm	0.2mm	0-100-0	flat back	45	62.5	19.5	15
2313-2FA *	2mm	6µm	2.5µm	0.2mm	0-100-0	flat back	45	62.5	19.5	15
2313-1A *	1mm	5µm	2µm	0.2mm	0-100-0	lug back	45	62.5	19.5	15
2313-2A *	2mm	6µm	2.5µm	0.2mm	0-100-0	lug back	45	62.5	19.5	15

*Supplied with manufacturer inspection certificate

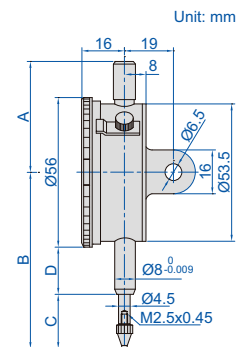

COMPACT DIAL INDICATORS

- Meet DIN878
- Jeweled bearing
- Supplied with limit pointers and bezel clamp
- Optional accessory: backs (page 222~223), contact points (page 219~221)



2311-5

JEWELLED BEARING

INSPECTION CERTIFICATE

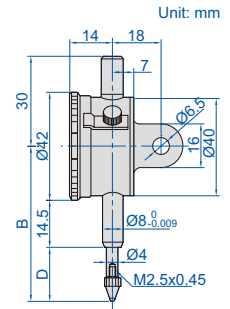

Code	Range	Graduation	Accuracy	Hysteresis	Range/rev	Dial reading	Remark	B	D
2311-3F *	3mm	0.01mm	12µm	3µm	0.5mm	0-50	flat back	46	10.5
2311-5F *	5mm	0.01mm	14µm	3µm	0.5mm	0-50	flat back	48	12.5
2311-3 *	3mm	0.01mm	12µm	3µm	0.5mm	0-50	lug back	46	10.5
2311-5 *	5mm	0.01mm	14µm	3µm	0.5mm	0-50	lug back	48	12.5

* Supplied with manufacturer inspection certificate

10

DIAL INDICATORS (STANDARD TYPE)

- Meet DIN878
- Jeweled bearing
- Supplied with limit pointers and bezel clamp
- Optional accessory: backs (page 222~223), contact points (page 219~221)



2308-10A

JEWELLED BEARING

INSPECTION CERTIFICATE

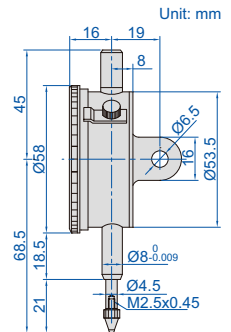

Code	Range	Graduation	Accuracy	Hysteresis	Range/rev	Dial reading	Remark
2308-3FA *	3mm	0.01mm	12µm	3µm	1mm	0-100	flat back
2308-5FA *	5mm	0.01mm	14µm	3µm	1mm	0-100	flat back
2308-10FA *	10mm	0.01mm	17µm	3µm	1mm	0-100	flat back
2308-3A *	3mm	0.01mm	12µm	3µm	1mm	0-100	lug back
2308-5A *	5mm	0.01mm	14µm	3µm	1mm	0-100	lug back
2308-10A *	10mm	0.01mm	17µm	3µm	1mm	0-100	lug back

* Supplied with manufacturer inspection certificate

DIAL INDICATORS (BASIC TYPE)

- Meet DIN878
- Jeweled bearing
- Supplied with limit hands and bezel clamp
- Packed in carton box
- Optional accessory: backs (page 222~223), contact points (page 219~221)



2301-10

POPULAR MODEL

INSPECTION CERTIFICATE

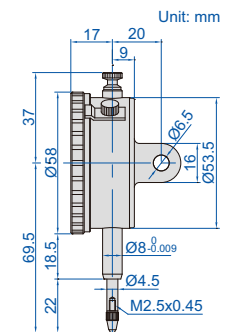

Code	Range	Graduation	Accuracy	Hysteresis	Range/rev	Dial reading	Remark
2301-10F *	10mm	0.01mm	17µm	3µm	1mm	0-100	flat back
2301-10 *	10mm	0.01mm	17µm	3µm	1mm	0-100	lug back with spare flat back

* Supplied with manufacturer inspection certificate



JEWELLED BEARING

REVERSE READING DIAL INDICATORS

- Meet DIN878
- Suitable for depth and step measurements
- Jeweled bearing
- Supplied with limit pointers and bezel clamp
- Optional accessory: backs (page 222~223), contact points (page 219~221)



2801-10

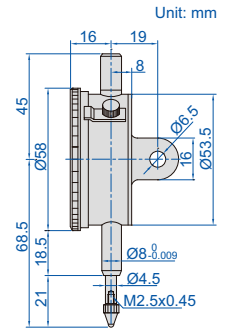

Code	Range	Graduation	Accuracy	Hysteresis	Range/rev	Dial reading	Remark
2801-10F *	10mm	0.01mm	17µm	3µm	1mm	100-0	flat back
2801-10 *	10mm	0.01mm	17µm	3µm	1mm	100-0	lug back

*Supplied with manufacturer inspection certificate

10



SHOCK PROOF

JEWELLED BEARING

SHOCKPROOF DIAL INDICATORS

- Meet DIN878
- Shockproof
- Jeweled bearing
- Supplied with limit pointers and bezel clamp
- Optional accessory: backs (page 222~223), contact points (page 219~221)



2314-10A

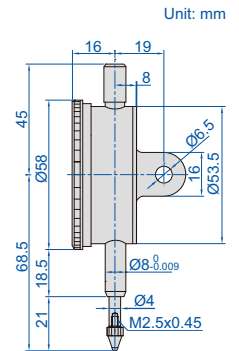

Code	Range	Graduation	Accuracy	Hysteresis	Range/rev	Dial reading	Remark
2314-3FA *	3mm	0.01mm	12µm	3µm	1mm	0-100	flat back
2314-5FA *	5mm	0.01mm	14µm	3µm	1mm	0-100	flat back
2314-10FA *	10mm	0.01mm	17µm	3µm	1mm	0-100	flat back
2314-3A *	3mm	0.01mm	12µm	3µm	1mm	0-100	lug back
2314-5A *	5mm	0.01mm	14µm	3µm	1mm	0-100	lug back
2314-10A *	10mm	0.01mm	17µm	3µm	1mm	0-100	lug back

*Supplied with manufacturer inspection certificate

IP54 WATERPROOF



WATERPROOF DIAL INDICATORS

- Meet DIN878
- IP54 dust/waterproof
- With limit pointers
- Optional accessory: backs (page 222~223), contact points (page 219~221)



2324-10A

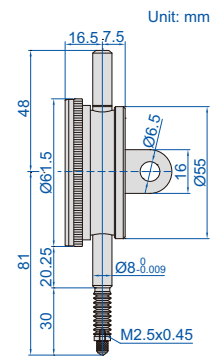

Code	Range	Graduation	Accuracy	Hysteresis	Range/rev	Dial reading	Remark
2324-10FA *	10mm	0.01mm	17µm	3µm	1mm	0-100	flat back
2324-10A *	10mm	0.01mm	17µm	3µm	1mm	0-100	lug back

*Supplied with manufacturer inspection certificate

DIAL INDICATORS (LONG STROKE)



- Supplied with limit pointers and bezel clamp
- Optional accessory: backs (page 222~223), contact points (page 219~221)



2310-30A

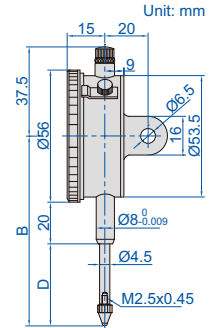

Code	Range	Graduation	Accuracy	Hysteresis	Range/rev	Dial reading	Remark	B	D
2310-20FA *	20mm	0.01mm	25µm	5µm	1mm	0-100	flat back	83	35
2310-30FA *	30mm	0.01mm	35µm	7µm	1mm	0-100	flat back	88	40
2310-20A *	20mm	0.01mm	25µm	5µm	1mm	0-100	lug back	83	35
2310-30A *	30mm	0.01mm	35µm	7µm	1mm	0-100	lug back	88	40

* Supplied with manufacturer inspection certificate

10

DIAL INDICATORS (LONG STROKE, BASIC TYPE)



- Supplied with limit pointers and bezel clamp
- Packed in carton box
- Optional accessory: backs (page 222~223), contact points (page 219~221)



2302-25

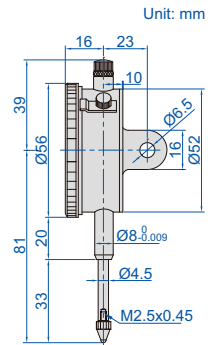

Code	Range	Graduation	Accuracy	Hysteresis	Range/rev	Dial reading	Remark
2302-25F *	25mm	0.01mm	35µm	7µm	1mm	0-100	flat back
2302-25 *	25mm	0.01mm	35µm	7µm	1mm	0-100	lug back with spare flat back

* Supplied with manufacturer inspection certificate

DOUBLE FACE DIAL INDICATOR



- Meet DIN878
- Read from both sides
- Jeweled bearing
- Supplied with limit pointers
- Optional accessory: contact points (page 219~221)



front

2328-10

back

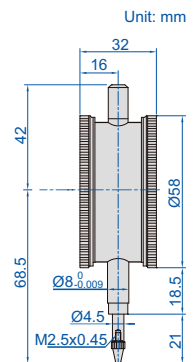

Code	Range	Graduation	Accuracy	Hysteresis	Range/rev	Dial reading
2328-10 *	10mm	0.01mm	17µm	3µm	1mm	0-100

* Supplied with manufacturer inspection certificate

DIAL INDICATORS (GRADUATION 0.1mm)



2318-30

- Supplied with limit pointers and bezel clamp
- Optional accessory: backs (page 222~223), contact points (page 219~221)

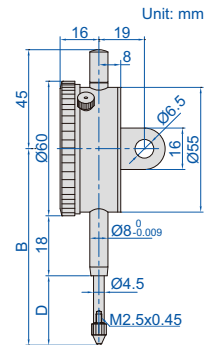

Code	Range	Graduation	Accuracy	Hysteresis	Range/rev	Dial reading	Remark	B	D
2318-10F	10mm	0.1mm	40µm	20µm	10mm	0-10	flat back	70	20
2318-20F	20mm	0.1mm	50µm	20µm	10mm	0-10	flat back	85	35
2318-25F	25mm	0.1mm	60µm	20µm	10mm	0-10	flat back	85	35
2318-30F	30mm	0.1mm	60µm	20µm	10mm	0-10	flat back	90	40
2318-10	10mm	0.1mm	40µm	20µm	10mm	0-10	lug back	70	20
2318-20	20mm	0.1mm	50µm	20µm	10mm	0-10	lug back	85	35
2318-25	25mm	0.1mm	60µm	20µm	10mm	0-10	lug back	85	35
2318-30	30mm	0.1mm	60µm	20µm	10mm	0-10	lug back	90	40

10



JEWELLED BEARING

SHOCK PROOF

DIAL INDICATORS (LONG STROKE)

- Shockproof
- Jeweled bearing
- Supplied with limit pointers
- Optional accessory: backs (page 222~223), contact points (page 219~221)



2309-50

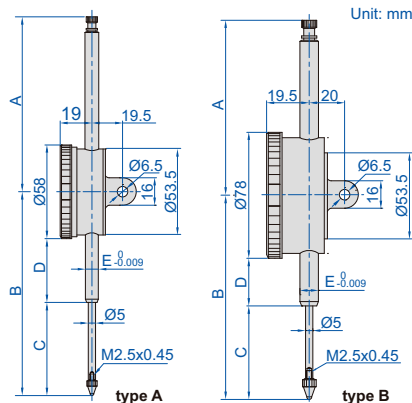

stem clamp Ø10mm for 2309-100D



back of type B



Code	Type	A	B	C	D	E
2309-30F	A	37.5	89.5	40.9	19.5	Ø8
2309-30	A	37.5	89.5	40.9	19.5	Ø8
2309-50	A	108.3	126.2	57.7	39.5	Ø8
2309-50D	B	108.3	126.2	57.7	29.5	Ø8
2309-80	A	138.4	168.4	88	51.3	Ø8
2309-80D	B	138.4	168.4	88	41.3	Ø8
2309-100D	B	167.6	207.8	108	60.8	Ø10

Code	Range	Graduation	Type	Accuracy	Hysteresis	Range/rev	Dial reading	Remark
2309-30F *	30mm	0.01mm	A	35µm	7µm	1mm	0-100	flat back
2309-30 *	30mm	0.01mm	A	35µm	7µm	1mm	0-100	lug back
2309-50 *	50mm	0.01mm	A	40µm	8µm	1mm	0-100	flat back with spare lug back
2309-50D *	50mm	0.01mm	B	40µm	8µm	1mm	0-100	flat back with spare lug back
2309-80	80mm	0.01mm	A	50µm	9µm	1mm	0-100	flat back with spare lug back
2309-80D	80mm	0.01mm	B	50µm	9µm	1mm	0-100	flat back with spare lug back
2309-100D	100mm	0.01mm	B	50µm	9µm	1mm	0-100	flat back with spare lug back

Note: 1) 2309-80, 2309-80D and 2309-100D can only be used vertically
 2) 2309-100D is supplied with stem clamp Ø10mm for magnetic stands (code 6200-60, 6201-60, 6202-80, 6202-100)
 3) 2309-30 and 2309-30F can not accept optional backs (page 222~223)

* Supplied with manufacturer inspection certificate

ONE REVOLUTION DIAL INDICATORS

- Meet DIN878
- Eliminate the possibility of reading errors due to miscounting
- Shockproof
- Supplied with limit pointers
- Optional accessory: backs (page 222-223), contact points (page 219-221)



2316-05

SHOCK PROOF

INSPECTION CERTIFICATE

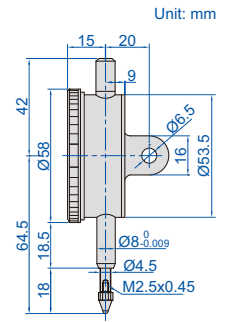

Code	Range	Dial indicator stroke	Graduation	Accuracy	Hysteresis	Dial reading	Remark
2316-05F *	0.5mm	5mm	0.01mm	9µm	3µm	25-0-25	flat back
2316-1F *	1mm	5mm	0.01mm	9µm	3µm	50-0-50	flat back
2316-05 *	0.5mm	5mm	0.01mm	9µm	3µm	25-0-25	lug back
2316-1 *	1mm	5mm	0.01mm	9µm	3µm	50-0-50	lug back

* Supplied with manufacturer inspection certificate

10

INCH DIAL INDICATORS

- Meet ASME B89.1.10M-2001
- With lug back
- Supplied with limit pointers and bezel clamp



2307-1

INSPECTION CERTIFICATE

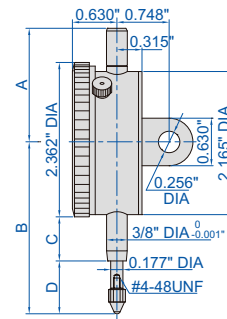

Code	Range	Graduation	Accuracy		Range/rev	Dial reading
			First 2.5 rev	Overall		
2307-025 *	0.25"	0.001"	±0.001"	±0.001"	0.1"	0-100
2307-05 *	0.5"	0.001"	±0.001"	±0.002"	0.1"	0-100
2307-1 *	1"	0.001"	±0.001"	±0.002"	0.1"	0-100
2307-2 *	2"	0.001"	±0.001"	±0.004"	0.1"	0-100
2307-0255 *	0.25"	0.0005"	±0.0005"	±0.0015"	0.05"	0-50
2307-055 *	0.5"	0.0005"	±0.0005"	±0.0015"	0.05"	0-50
2307-105 *	1"	0.0005"	±0.0005"	±0.002"	0.05"	0-50
2307-205 *	2"	0.0005"	±0.0005"	±0.002"	0.05"	0-50

* Supplied with manufacturer inspection certificate

Range	A	B	C	D
0.25"	1.811"	2.953"	0.787"	0.984"
0.5"	1.811"	2.953"	0.787"	0.984"
1"	1.811"	3.346"	0.787"	1.378"
2"	4.370"	5.472"	1.969"	2.323"

INCH LONG STROKE DIAL INDICATOR

- Graduation 0.001"
- With lug back
- Supplied with limit pointers and bezel clamp



2326-2

INSPECTION CERTIFICATE

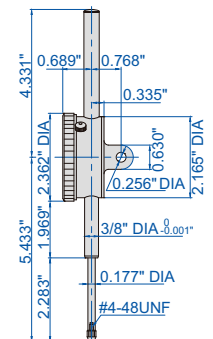

Code	Range	Accuracy		Range/rev	Dial reading
		first 2.5 rev	overall		
2326-2 *	2"	±0.001"	±0.004"	0.1"	0-100

* Supplied with manufacturer inspection certificate

BALL POINTS



6282-0101

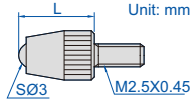

Code	Material of measuring face	L (mm)
6282-0101	carbide	7.3
6282-0103	ceramic	7.3
6282-0104	carbide	8.3
6282-0106	carbide	12.1
6282-0107	carbide	14
6282-0108	carbide	15
6282-0109	ceramic	15
6282-0110	carbide	17

Code	Material of measuring face	L (mm)
6282-0111	carbide	19.3
6282-0112	carbide	20
6282-0113	ceramic	20
6282-0114	carbide	22
6282-0115	carbide	25
6282-0116	ceramic	25
6282-0117	carbide	30
6282-0118	ceramic	30



6282-0301

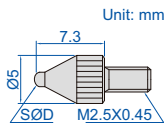

6282-0304

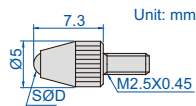

Code	Material of measuring face	SØD (mm)
6282-0301	steel	1
6282-0302	carbide	1.5
6282-0303	carbide	1.8
6282-0304	carbide	2.5
6282-0305	carbide	4

10

SHELL TYPE POINTS



6282-0202

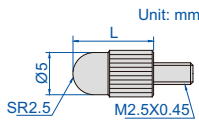

Code	Material of measuring face	L (mm)
6282-0202	steel	5
6282-0203	steel	10
6282-0205	steel	15

Code	Material of measuring face	L (mm)
6282-0207	steel	20
6282-0208	steel	25
6282-0210	steel	30

SPHERICAL POINT



6282-0401

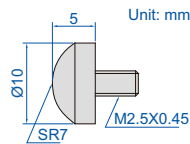

Code	Material of measuring face
6282-0401	steel

CONICAL POINTS

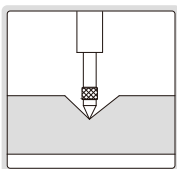

6282-0601



6282-0701



6282-0801



6282-0901

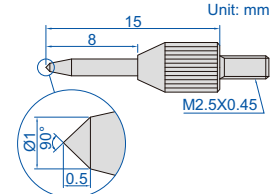
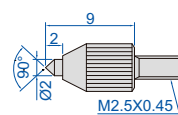
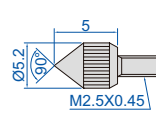
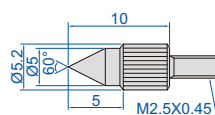

Code	Material of measuring face
6282-0601	steel
6282-0701	steel
6282-0801	steel
6282-0901	steel

FLAT POINTS



6282-1101

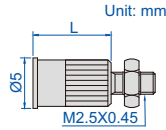

Code	Material of measuring face	L (mm)
6282-1101	steel	8
6282-1102	steel	10



6282-1301

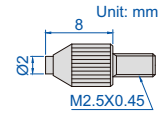

Code	Material of measuring face
6282-1301	carbide



6282-1201

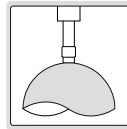
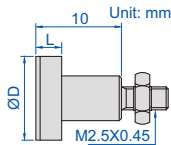

Code	Material of measuring face	ØD	L
6282-1201	steel	10mm	3mm
6282-1202	steel	15mm	4mm
6282-1203	steel	20mm	3mm
6282-1204	steel	25mm	4mm
6282-1205	steel	30mm	4mm

10

NEEDLE POINTS



6282-1711

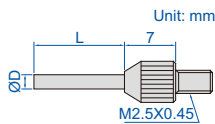

Code	Material of measuring face	ØD	L
6282-1701	steel	0.45	3
6282-1702	steel	0.45	5
6282-1703	carbide	1	3
6282-1704	carbide	1	5
6282-1705	carbide	1	8
6282-1706	carbide	1	10
6282-1707	carbide	1	20
6282-1708	carbide	1	40
6282-1709	carbide	1.5	5

Code	Material of measuring face	ØD	L
6282-1710	carbide	1.5	10
6282-1711	carbide	1.5	13
6282-1712	carbide	1.5	20
6282-1713	carbide	1.5	40
6282-1714	carbide	2	8
6282-1715	carbide	2	18
6282-1716	carbide	2	28
6282-1717	carbide	2	40



6282-1601

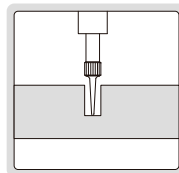
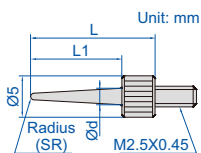

Code	Material of measuring face	L1	L	SR	Ød
6282-1601	steel	11	15	0.4	2
6282-1602	steel	13	17	0.2	2
6282-1603	steel	21	25	0.4	3
6282-1604	steel	31	35	0.4	3

KNIFE EDGE POINT



6282-1001

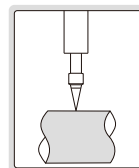
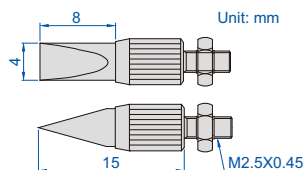

Code	Material of measuring face
6282-1001	steel



BLADE POINTS

Code	Material of measuring face	D	W
6282-1801	steel	0.4mm	2mm
6282-1802	steel	0.6mm	2mm
6282-1803	steel	1mm	4mm



6282-1801

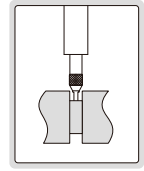
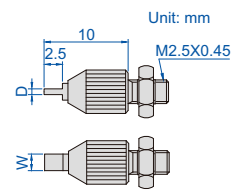

ROLLER POINT

Code	Material of measuring face
6282-1901	steel



6282-1901

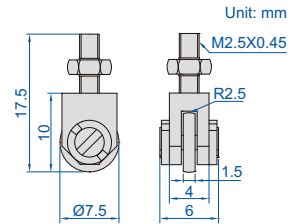

10

EXTENSION RODS

Code	Material	L (mm)
6282-2001	steel	10
6282-2002	steel	15
6282-2003	steel	20
6282-2004	steel	25
6282-2005	steel	30
6282-2006	steel	35
6282-2007	steel	40
6282-2008	steel	45
6282-2009	steel	50

Code	Material	L (mm)
6282-2010	steel	55
6282-2011	steel	60
6282-2012	steel	65
6282-2013	steel	70
6282-2014	steel	75
6282-2015	steel	80
6282-2016	steel	90
6282-2017	steel	100



6282-2010

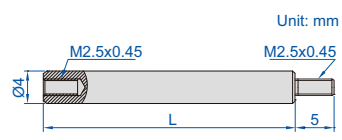

POINT SET



6282-S6

Code	Material of measuring face
6282-S6	steel

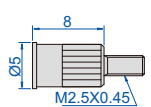

flat point

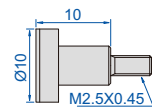

flat point

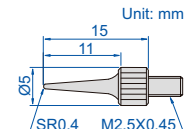

needle point

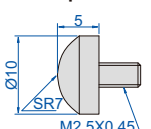

spherical point

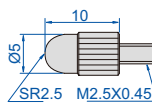

shell type point

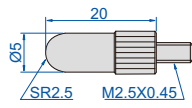

shell type point

SPINDLE LIFT KNOB

- For dial/digital indicators with spindle diameter $\varnothing 4.5\text{mm}$ or $\varnothing 5\text{mm}$

Code

7332



7332

SHAFT SLEEVE

10

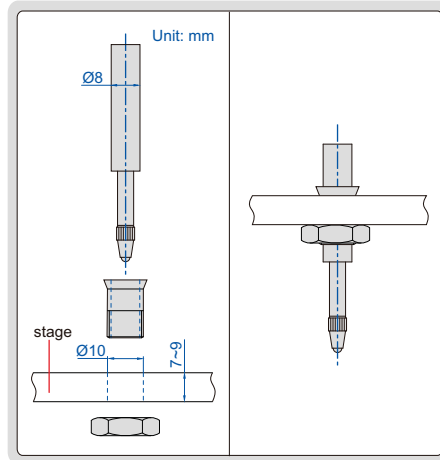

7333

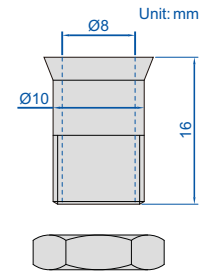

- For dial indicators and probes with shaft diameter $\varnothing 8\text{mm}$

Code

7333

MAGNETIC BACKS

Code	ØD	For digital/dial indicators
7331-M1	51.5mm	2103
		2104
		2108
		2109
		2112
		2115
		2116
		2117
		2118
		2138
		2139
		2501
		2301
		2302
		2308
		2309 (except 2309-30, 2309-30F)
		2313
2314		
2316		
2324		
2801		
7331-M2	54mm	2318



front



back

7331-M2

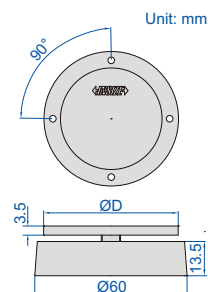

FLAT BACKS



7330-F2

Code	For digital/dial indicators
7330-F1	2311
7330-F2	2301
	2302
	2308
	2309 (except 2309-30, 2309-30F)
	2313
	2314
	2316
	2324
	2801

Code	For digital/dial indicators
7330-F5	2103
	2104
	2108
	2109
	2112
	2115
	2116
	2117
	2118
	2138
	2139
2501	
7330-F6	2318
7330-F10	2310

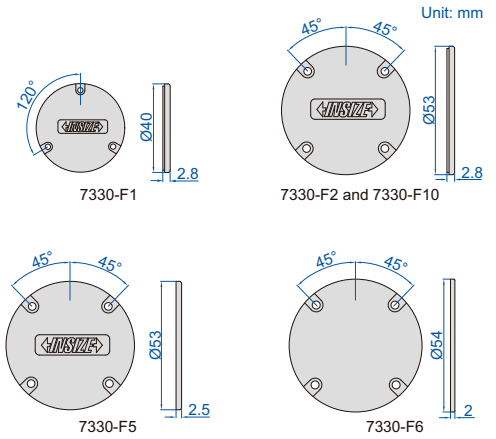

10

LUG BACKS



7330-L2

Code	For digital/dial indicators
7330-L1	2311
7330-L2	2301
	2302
	2308
	2309 (except 2309-30, 2309-30F)
	2313
	2314
	2316
	2324
	2801

Code	For digital/dial indicators
7330-L5	2103
	2104
	2108
	2109
	2112
	2115
	2116
	2117
	2118
	2138
	2139
2501	
7330-L6	2318
7330-L10	2310

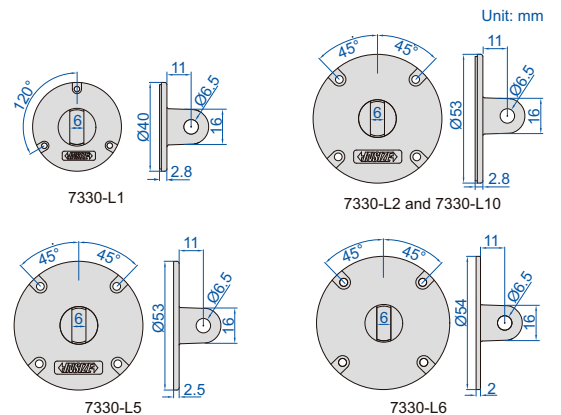

DIAL INDICATOR TESTER CODE 2396-25A

ATTENTION: NOT SUITABLE FOR DIAL INDICATORS WITH GRADUATION 0.001MM



- To calibrate dial indicators, test indicators and dial bore gages
- Dimension: 270x210x205mm
- Weight: 11kg

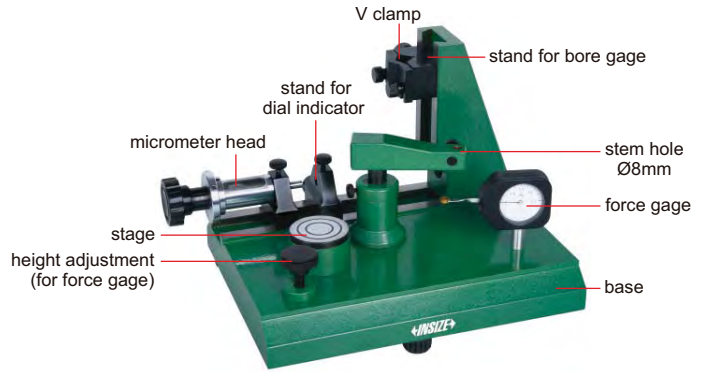

2396-25A

Micrometer head

Range	Sampling interval	Accuracy	Hysteresis
0-25mm	0.1mm	4µm (0-25mm), 3µm (0-10mm), 2µm (0-1mm)	1µm

Force gage

Range	Graduation	Accuracy
0-1.6N	0.05N	±5% (of load capacity)

Stage

Diameter	Flatness	Roughness
50mm	1µm	0.05µm



inspect accuracy of dial indicators (range 0-25mm)



inspect accuracy of dial bore gages (range 6-450mm)



inspect accuracy of test indicators



check force of dial indicators



check repeatability of dial indicators



check the effect of lateral force on accuracy of dial indicators (half round gage block is required)



check the effect of lateral force on accuracy of test indicators (half round gage block is required)

Half round gage block (optional)

Code	Parallelism
2396-block	1µm





LINEAR GAGES AND DISPLAY UNIT

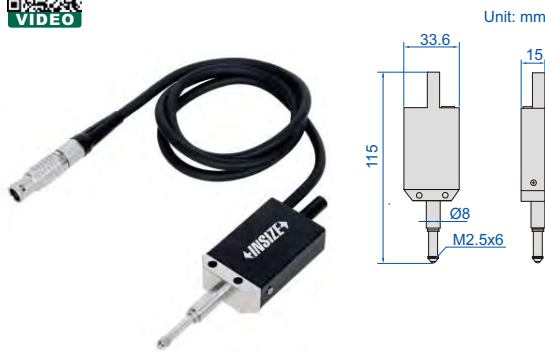

linear gage
7131-01



display unit
7131-1A

- Linear gage type: optical grating
- Display unit: display displacement data in real time, data preset, set tolerance and make judgment (out of upper tolerance, within tolerance, out of lower tolerance), set zero, change measuring direction, resolution (0.1µm/1µm), unit switch (µm/mm/inch)
- Two data transmission methods: can output keyboard signal and data can be transmitted to excel, word, txt etc, can also output serial signal and transmit data to serial communication software

LINEAR GAGE SPECIFICATION

Code	7131-01	7131-02
Range	12.5mm	12.5mm
Resolution	0.1µm	1µm
Accuracy (19~20°C)	1µm	3µm
Repeatability	0.2µm	2µm
Linear gage type	optical grating	
Working life	ten million times	
Dust/waterproof	IP50	
Measuring force	0.7±0.3N	
Cable length	900mm	
Operation environment	0~40°C, 20~80%RH	
Power supply	5~24V	
Dimension (L×W×H)	33.6×15×115mm	
Weight	133g	

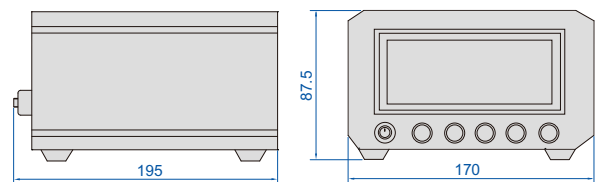

Unit: mm

application

spindle lift knob is included



DISPLAY UNIT SPECIFICATION

Code	7131-1A
Display	4" LCD screen
Unit	µm, mm, inch
Quantity of linear gage to be connected	1 pc
Dimension (L×W×H)	170×195×87.5mm
Weight	1.45kg



DUSTPROOF
WATERPROOF

ABSOLUTE ENCODER, THE ORIGINAL
DATA REMAINS AFTER POWER OFF

DIGITAL LINEAR GAGES

- Scale type: optical grating
- Absolute encoder, the original data remains after power off
- Digital signal output, amplifier is not required
- Measuring force: ≤1.5N
- Dust/waterproof: IP43/IP66
- Baud rate: 9600 (can be customized)
- Cable length: 3m (can be customized)



7130-10



7130-10L

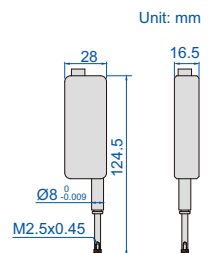





Unit: mm

To be continued





Continued from previous page

Dust/waterproof IP43, resolution 0.1µm





Code	Range	Repeatability	Accuracy	Outgoing cable direction	Output signal	Output interface
7130-10	0-12.5mm	0.5µm	1µm	horizontal	RS232, TTL level	
7130-10L	0-12.5mm	0.5µm	1µm	vertical	RS232, TTL level	
7130-11	0-12.5mm	0.5µm	1µm	horizontal	RS232, 232 level	
7130-11L	0-12.5mm	0.5µm	1µm	vertical	RS232, 232 level	
7130-12	0-12.5mm	0.5µm	1µm	horizontal	RS485	
7130-12L	0-12.5mm	0.5µm	1µm	vertical	RS485	
7130-13	0-12.5mm	0.5µm	1µm	horizontal	RS232, TTL level	
7130-13L	0-12.5mm	0.5µm	1µm	vertical	RS232, TTL level	
7130-14	0-12.5mm	0.5µm	1µm	horizontal	RS232, 232 level	
7130-14L	0-12.5mm	0.5µm	1µm	vertical	RS232, 232 level	

10





Dust/waterproof IP43, resolution 0.5µm

Code	Range	Repeatability	Accuracy	Outgoing cable direction	Output signal	Output interface
7130-20	0-12.5mm	1.5µm	3µm	horizontal	RS232, TTL level	
7130-20L	0-12.5mm	1.5µm	3µm	vertical	RS232, TTL level	
7130-21	0-12.5mm	1.5µm	3µm	horizontal	RS232, 232 level	
7130-21L	0-12.5mm	1.5µm	3µm	vertical	RS232, 232 level	
7130-22	0-12.5mm	1.5µm	3µm	horizontal	RS485	
7130-22L	0-12.5mm	1.5µm	3µm	vertical	RS485	
7130-23	0-12.5mm	1.5µm	3µm	horizontal	RS232, TTL level	
7130-23L	0-12.5mm	1.5µm	3µm	vertical	RS232, TTL level	
7130-24	0-12.5mm	1.5µm	3µm	horizontal	RS232, 232 level	
7130-24L	0-12.5mm	1.5µm	3µm	vertical	RS232, 232 level	

Dust/waterproof IP66, resolution 0.1µm

Code	Range	Repeatability	Accuracy	Outgoing cable direction	Output signal	Output interface
7130-30	0-12.5mm	0.5µm	1µm	horizontal	RS232, TTL level	
7130-30L	0-12.5mm	0.5µm	1µm	vertical	RS232, TTL level	
7130-31	0-12.5mm	0.5µm	1µm	horizontal	RS232, 232 level	
7130-31L	0-12.5mm	0.5µm	1µm	vertical	RS232, 232 level	
7130-32	0-12.5mm	0.5µm	1µm	horizontal	RS485	
7130-32L	0-12.5mm	0.5µm	1µm	vertical	RS485	
7130-33	0-12.5mm	0.5µm	1µm	horizontal	RS232, TTL level	
7130-33L	0-12.5mm	0.5µm	1µm	vertical	RS232, TTL level	
7130-34	0-12.5mm	0.5µm	1µm	horizontal	RS232, 232 level	
7130-34L	0-12.5mm	0.5µm	1µm	vertical	RS232, 232 level	

Dust/waterproof IP66, resolution 0.5µm

Code	Range	Repeatability	Accuracy	Outgoing cable direction	Output signal	Output interface
7130-40	0-12.5mm	1.5µm	3µm	horizontal	RS232, TTL level	
7130-40L	0-12.5mm	1.5µm	3µm	vertical	RS232, TTL level	
7130-41	0-12.5mm	1.5µm	3µm	horizontal	RS232, 232 level	
7130-41L	0-12.5mm	1.5µm	3µm	vertical	RS232, 232 level	
7130-42	0-12.5mm	1.5µm	3µm	horizontal	RS485	
7130-42L	0-12.5mm	1.5µm	3µm	vertical	RS485	
7130-43	0-12.5mm	1.5µm	3µm	horizontal	RS232, TTL level	
7130-43L	0-12.5mm	1.5µm	3µm	vertical	RS232, TTL level	
7130-44	0-12.5mm	1.5µm	3µm	horizontal	RS232, 232 level	
7130-44L	0-12.5mm	1.5µm	3µm	vertical	RS232, 232 level	



**DUSTPROOF
WATERPROOF**

**ABSOLUTE ENCODER, THE ORIGINAL
DATA REMAINS AFTER POWER OFF**

PNEUMATIC DIGITAL LINEAR GAGES

- Scale type: optical grating
- Absolute encoder, the original data remains after power off
- Digital signal output, amplifier is not required
- Air pressure: 0.2-0.5MPa
- Measuring force: $\leq 1.5N$
- Dust/waterproof: IP43/IP66
- Baud rate: 9600 (can be customized)
- Cable length: 3m (can be customized)

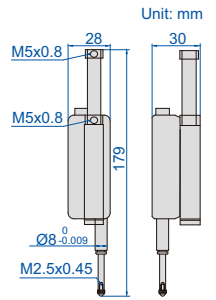

7134-10L

Dust/waterproof IP43, resolution 0.1µm

Code	Range	Repeatability	Accuracy	Outgoing cable direction	Output signal	Output interface
7134-10	0-12.5mm	0.5µm	1µm	horizontal	RS232, TTL level	
7134-10L	0-12.5mm	0.5µm	1µm	vertical	RS232, TTL level	
7134-11	0-12.5mm	0.5µm	1µm	horizontal	RS232, 232 level	
7134-11L	0-12.5mm	0.5µm	1µm	vertical	RS232, 232 level	
7134-12	0-12.5mm	0.5µm	1µm	horizontal	RS485	
7134-12L	0-12.5mm	0.5µm	1µm	vertical	RS485	
7134-13	0-12.5mm	0.5µm	1µm	horizontal	RS232, TTL level	
7134-13L	0-12.5mm	0.5µm	1µm	vertical	RS232, TTL level	
7134-14	0-12.5mm	0.5µm	1µm	horizontal	RS232, 232 level	
7134-14L	0-12.5mm	0.5µm	1µm	vertical	RS232, 232 level	

Dust/waterproof IP43, resolution 0.5µm

Code	Range	Repeatability	Accuracy	Outgoing cable direction	Output signal	Output interface
7134-20	0-12.5mm	1.5µm	3µm	horizontal	RS232, TTL level	
7134-20L	0-12.5mm	1.5µm	3µm	vertical	RS232, TTL level	
7134-21	0-12.5mm	1.5µm	3µm	horizontal	RS232, 232 level	
7134-21L	0-12.5mm	1.5µm	3µm	vertical	RS232, 232 level	
7134-22	0-12.5mm	1.5µm	3µm	horizontal	RS485	
7134-22L	0-12.5mm	1.5µm	3µm	vertical	RS485	
7134-23	0-12.5mm	1.5µm	3µm	horizontal	RS232, TTL level	
7134-23L	0-12.5mm	1.5µm	3µm	vertical	RS232, TTL level	
7134-24	0-12.5mm	1.5µm	3µm	horizontal	RS232, 232 level	
7134-24L	0-12.5mm	1.5µm	3µm	vertical	RS232, 232 level	

Dust/waterproof IP66, resolution 0.1µm

Code	Range	Repeatability	Accuracy	Outgoing cable direction	Output signal	Output interface
7134-30	0-12.5mm	0.5µm	1µm	horizontal	RS232, TTL level	
7134-30L	0-12.5mm	0.5µm	1µm	vertical	RS232, TTL level	
7134-31	0-12.5mm	0.5µm	1µm	horizontal	RS232, 232 level	
7134-31L	0-12.5mm	0.5µm	1µm	vertical	RS232, 232 level	
7134-32	0-12.5mm	0.5µm	1µm	horizontal	RS485	
7134-32L	0-12.5mm	0.5µm	1µm	vertical	RS485	
7134-33	0-12.5mm	0.5µm	1µm	horizontal	RS232, TTL level	
7134-33L	0-12.5mm	0.5µm	1µm	vertical	RS232, TTL level	
7134-34	0-12.5mm	0.5µm	1µm	horizontal	RS232, 232 level	
7134-34L	0-12.5mm	0.5µm	1µm	vertical	RS232, 232 level	

To be continued

Continued from previous page

Dust/waterproof IP66, resolution 0.5µm

Code	Range	Repeatability	Accuracy	Outgoing cable direction	Output signal	Output interface
7134-40	0-12.5mm	1.5µm	3µm	horizontal	RS232, TTL level	
7134-40L	0-12.5mm	1.5µm	3µm	vertical	RS232, TTL level	
7134-41	0-12.5mm	1.5µm	3µm	horizontal	RS232, 232 level	
7134-41L	0-12.5mm	1.5µm	3µm	vertical	RS232, 232 level	
7134-42	0-12.5mm	1.5µm	3µm	horizontal	RS485	
7134-42L	0-12.5mm	1.5µm	3µm	vertical	RS485	
7134-43	0-12.5mm	1.5µm	3µm	horizontal	RS232, TTL level	
7134-43L	0-12.5mm	1.5µm	3µm	vertical	RS232, TTL level	
7134-44	0-12.5mm	1.5µm	3µm	horizontal	RS232, 232 level	
7134-44L	0-12.5mm	1.5µm	3µm	vertical	RS232, 232 level	

10

LINEAR GAGES

LINEAR GAGE
IP65
WATERPROOF

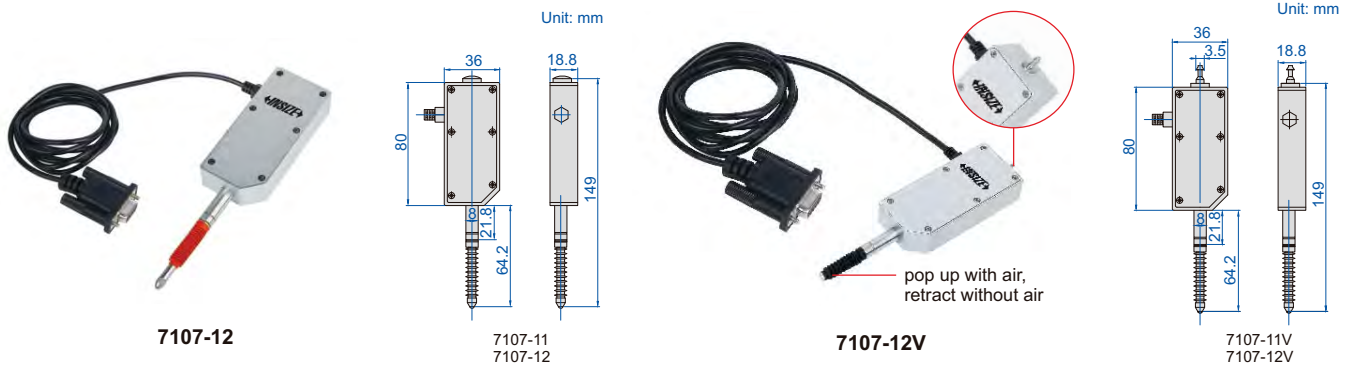

- Capacitance type linear encoder
- Shock-proof, water proof, dust proof, suitable for high speed movement, long working life
- Optional: display unit **7106-1A**, multichannel interface box **7107-1** or **7107-2**

SPECIFICATION

Code	7107-11	7107-12	7107-11V	7107-12V
Measuring range	12mm/0.47"	12mm/0.47"	12mm/0.47"	12mm/0.47"
Resolution	0.01mm/0.0004"	0.001mm/0.00004"	0.01mm/0.0004"	0.001mm/0.00004"
Accuracy	20µm	5µm	20µm	5µm
Hysteresis	10µm	2µm	10µm	2µm
Driving type	spring		pneumatic	
Measuring force	1.5N		adjusted by air pressure	
Measuring principle	capacitance type linear encoder			
Voltage	5V			
Sampling frequency	100 times/sec			
Working life	ten million times			
Dust/waterproof	IP65			
Cable length	2m			
Data output	RS232			



DISPLAY UNIT FOR CAPACITANCE LINEAR GAGES CODE 7106-1A

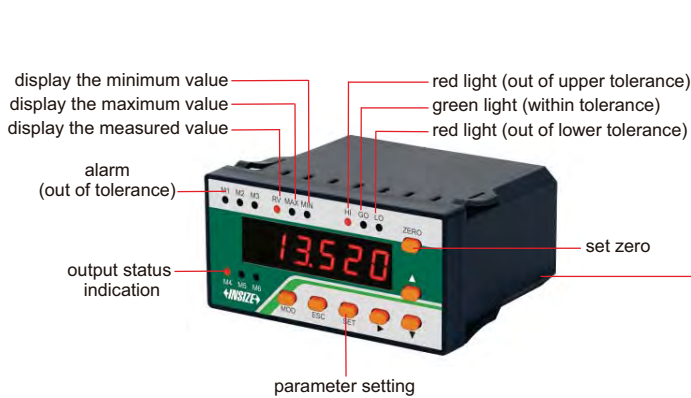

7106-1A

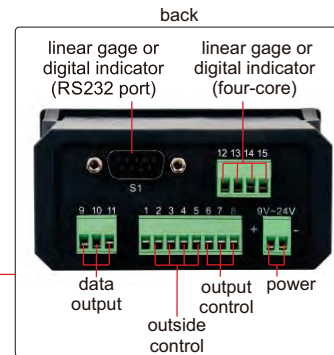

- Can be connected with 7107-11, 7107-12, 7107-11V or 7107-12V linear gage, can also be connected with digital indicator (data cable 7309-C01M is needed)
- Set tolerance and make judgment (out of upper tolerance, within tolerance, out of lower tolerance), output the judgment to control outside devices, control from outside (set zero, hold reading and collect data)
- Software of display unit (included): in the software, it is possible to set tolerance and show judgment (red when out of tolerance, green when within tolerance), set zero, collect data manually or automatically (time is adjustable), output data to Excel, print report

Unit: mm

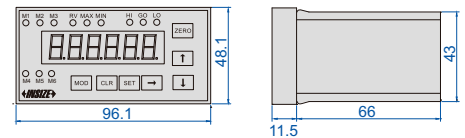

connected with 7107-11, 7107-12, 7107-11V or 7107-12V linear gage



connected with digital indicator (data cable 7309-C01M is needed)



software (included)

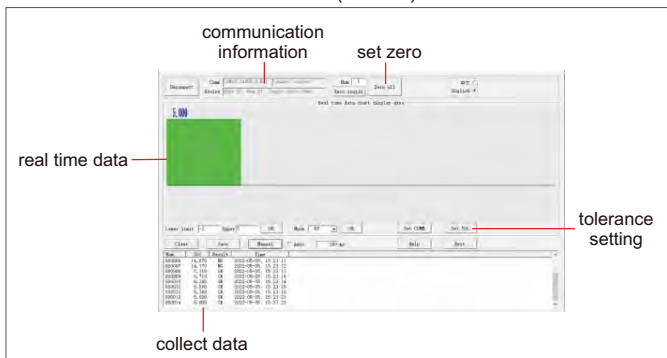

SPECIFICATION

Display	6 digits
Quantity of linear gage or digital indicator to be connected	1 pc
Tolerance	set tolerance and make judgment with alarm and lights (out of upper tolerance, within tolerance, out of lower tolerance)
Output control	output the tolerance judgment (out of upper tolerance, within tolerance, out of lower tolerance) to control outside devices
Outside control	control the display units from outside (set zero, hold reading and collect data)
Data output	connect to computer software and serial communication
Power supply	DC 9~24V

MULTICHANNEL INTERFACE BOXES FOR CAPACITANCE LINEAR GAGES



7107-1

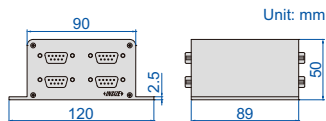

7107-1



7107-2

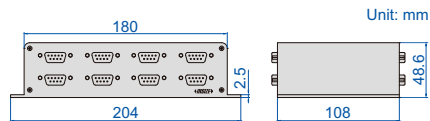

7107-2



7107-3

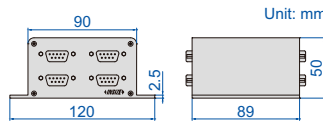

7107-3

- Can be connected with **7107-11**, **7107-12**, **7107-11V** or **7107-12V** linear gages, can also be connected with digital indicators (data cable **7309-C01M** is needed)
- Connection box (code: **7107-3**) is needed to connect interface boxes, when two or more interface boxes are used. Maximum 4 interface boxes can be connected.
- Software of interface boxes (included): in the software, it is possible to set tolerance of each channel and show judgment (red when out of tolerance, green when within tolerance), set zero, collect data manually or automatically (time is adjustable), output data to Excel, print report.

software (included)

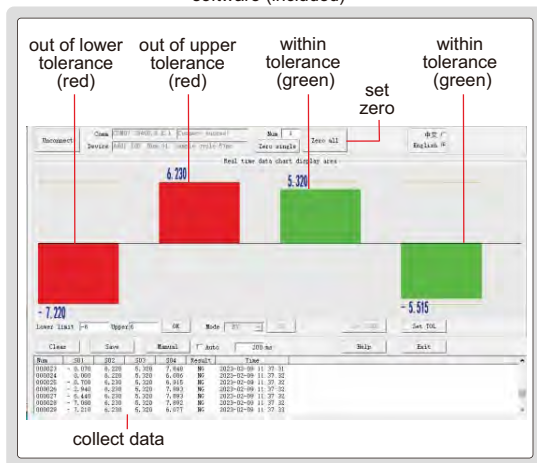

connected with **7107-11**, **7107-12**, **7107-11V** or **7107-12V** linear gages

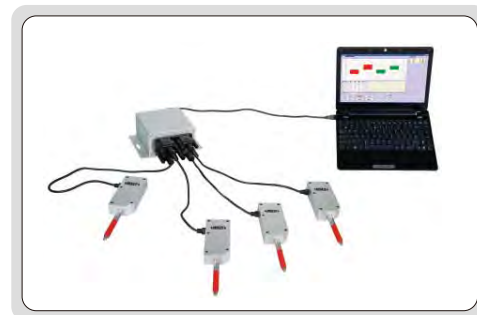

INTERFACE BOX SPECIFICATION

Code	7107-1	7107-2
Quantity of linear gages or digital indicators to be connected	4 pcs	8 pcs
Data output	RS232 and RS485	
Power supply	DC 9~24V	

CONNECTION BOX (OPTIONAL) SPECIFICATION

Code	7107-3
Quantity of interface boxes to be connected	4 pcs (maximum 4 interface boxes can be connected)
Data output	RS232 and RS485
Power supply	DC 9~24V

connected with digital indicators (data cable **7309-C01M** is needed)

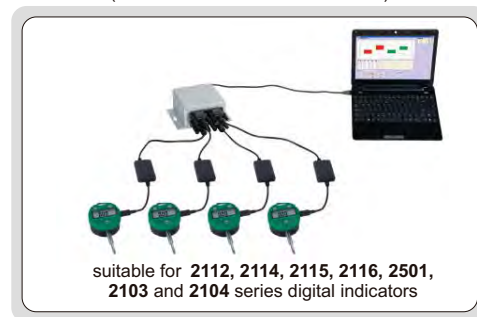

suitable for **2112**, **2114**, **2115**, **2116**, **2501**, **2103** and **2104** series digital indicators

DIAL TEST INDICATOR UNIVERSAL HOLDER



6297-1

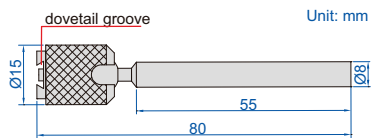

- Set the indicators at the desired attitude to the workpiece

Code

6297-1

DIAL TEST INDICATOR HOLDER



6296-1

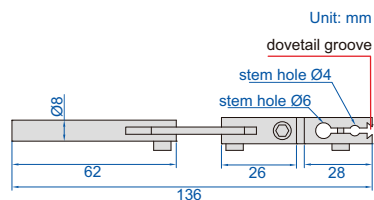

- Supplied with hex key

Code

6296-1

DIAL TEST INDICATOR HOLDERS



6293-1



6293-2

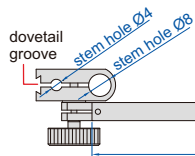

6293-1/6293-6

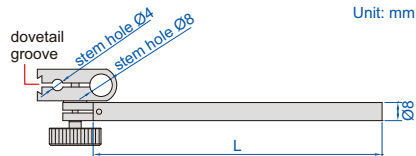

6293-2

Code	Stem section	Stem length (L)
6293-1	9x9mm	100mm
6293-6	9x9mm	50mm
6293-2	Ø8mm	115mm

DIAL TEST INDICATOR HOLDER

- Can be used with dial test indicators



6291-1

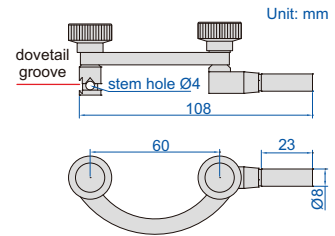

Code
6291-1

10

DIAL TEST INDICATOR HOLDER

- Can be used with dial test indicators



6295-1A

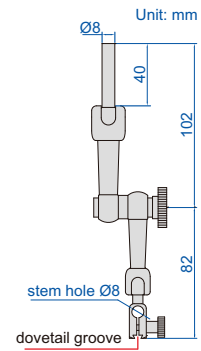

Code
6295-1A

DIAL INDICATOR HOLDER

- Can be used with dial test indicators or dial indicators



6294-1A

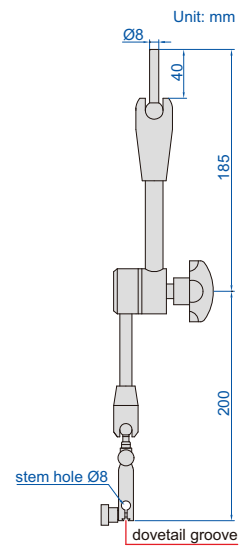

Code
6294-1A

HYDRAULIC UNIVERSAL MAGNETIC STANDS

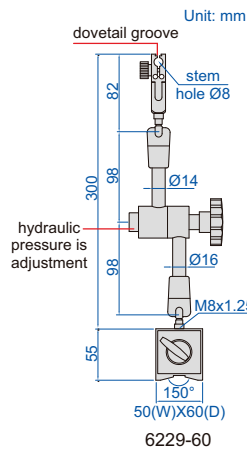

6229-60

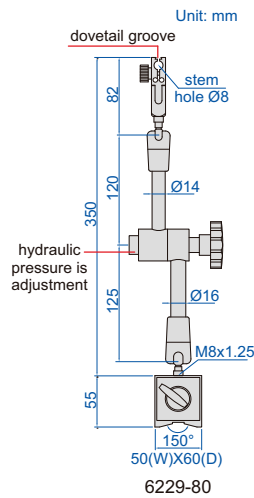

6229-80

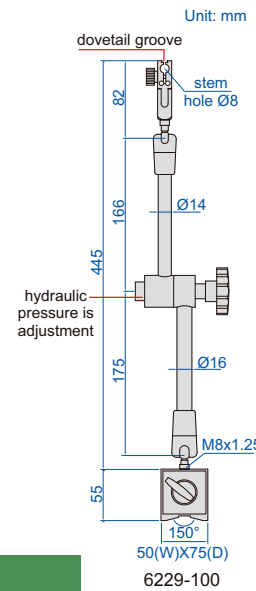

6229-100

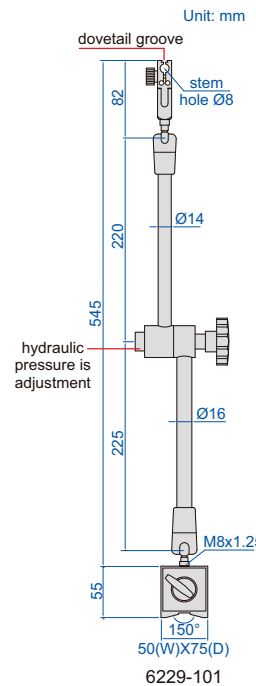

6229-101

- Hydraulic pressure is adjustment
- For digital/dial indicators and dial test indicators

Code	Magnetic force	Applicable holding stem	Remark
6229-60	60kgf	Ø8mm	with fine adjustment and dovetail groove
6229-80	80kgf	Ø8mm	with fine adjustment and dovetail groove
6229-100	100kgf	Ø8mm	with fine adjustment and dovetail groove
6229-101	100kgf	Ø8mm	with fine adjustment and dovetail groove

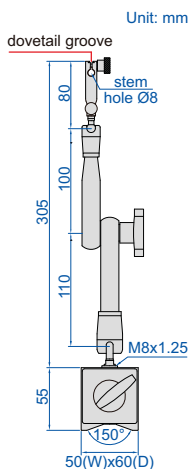

6219-80

LARGE LOCKING FORCE MAGNETIC STAND

- For digital/dial indicators and dial test indicators

Code	Magnetic force	Applicable holding stem	Remark
6219-80	80kgf	Ø8mm	with fine adjustment and dovetail groove

UNIVERSAL MAGNETIC STANDS

POPULAR MODEL

10

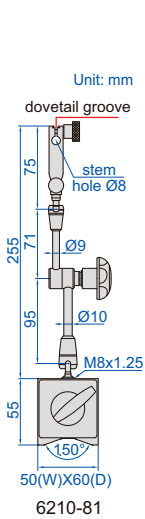

6210-81

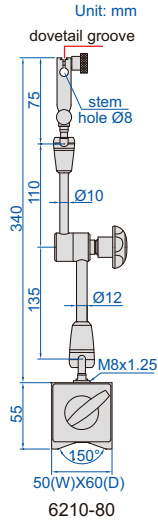

6210-80

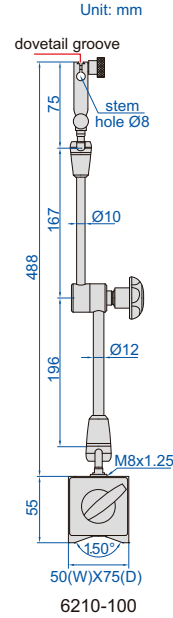

6210-100

■ For digital/dial indicators and dial test indicators

Code	Magnetic force	Applicable holding stem	Remark
6210-81	80kgf	Ø8mm	with fine adjustment and dovetail groove
6210-80	80kgf	Ø8mm	with fine adjustment and dovetail groove
6210-100	100kgf	Ø8mm	with fine adjustment and dovetail groove

UNIVERSAL MAGNETIC STAND (ECONOMIC TYPE)

ATTENTION: LOW LOCKING FORCE

■ For digital/dial indicators and dial test indicators



6208-80A

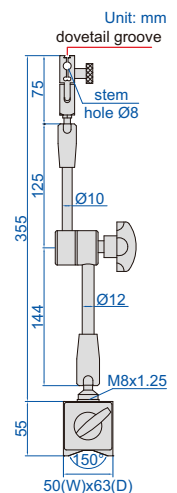

Code	Magnetic force	Applicable holding stem	Remark
6208-80A	80kgf	Ø8mm	with fine adjustment and dovetail groove

MAGNETIC STAND WITH TWO FINE ADJUSTMENTS

- With two fine adjustments on the head and on the base
- For digital/dial indicators and dial test indicators

Code	Magnetic force	Applicable holding stem	Remark
6272-80	80kgf	Ø8mm	with two fine adjustments and dovetail groove

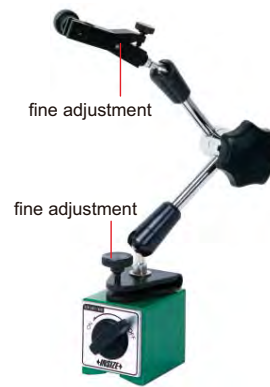

6272-80

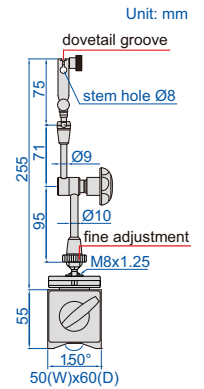

ATTENTION: FOR DIAL TEST INDICATORS ONLY

HYDRAULIC MINI MAGNETIC STAND

- For dial test indicators
- With fine adjustment and dovetail groove
- Adjustable hydraulic force

Code	Magnetic force	Applicable holding stem
6228-40	40kgf	Ø8mm



6228-40

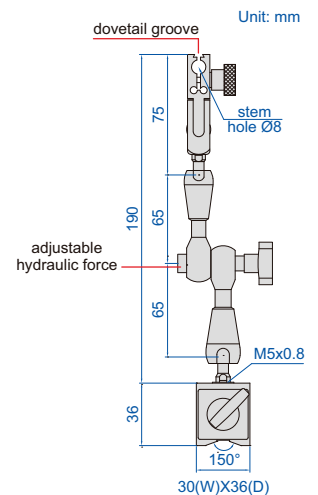

ATTENTION: FOR DIAL TEST INDICATORS ONLY

MINI MAGNETIC STAND

- For dial test indicators
- With fine adjustment and dovetail groove

Code	Magnetic force	Applicable holding stem
6224-40	40kgf	Ø8mm



6224-40

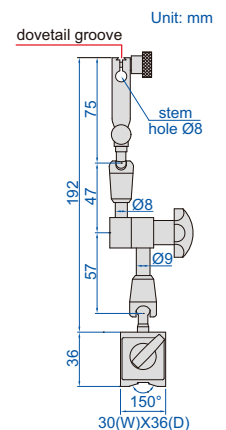

MAGNETIC STANDS

POPULAR MODEL

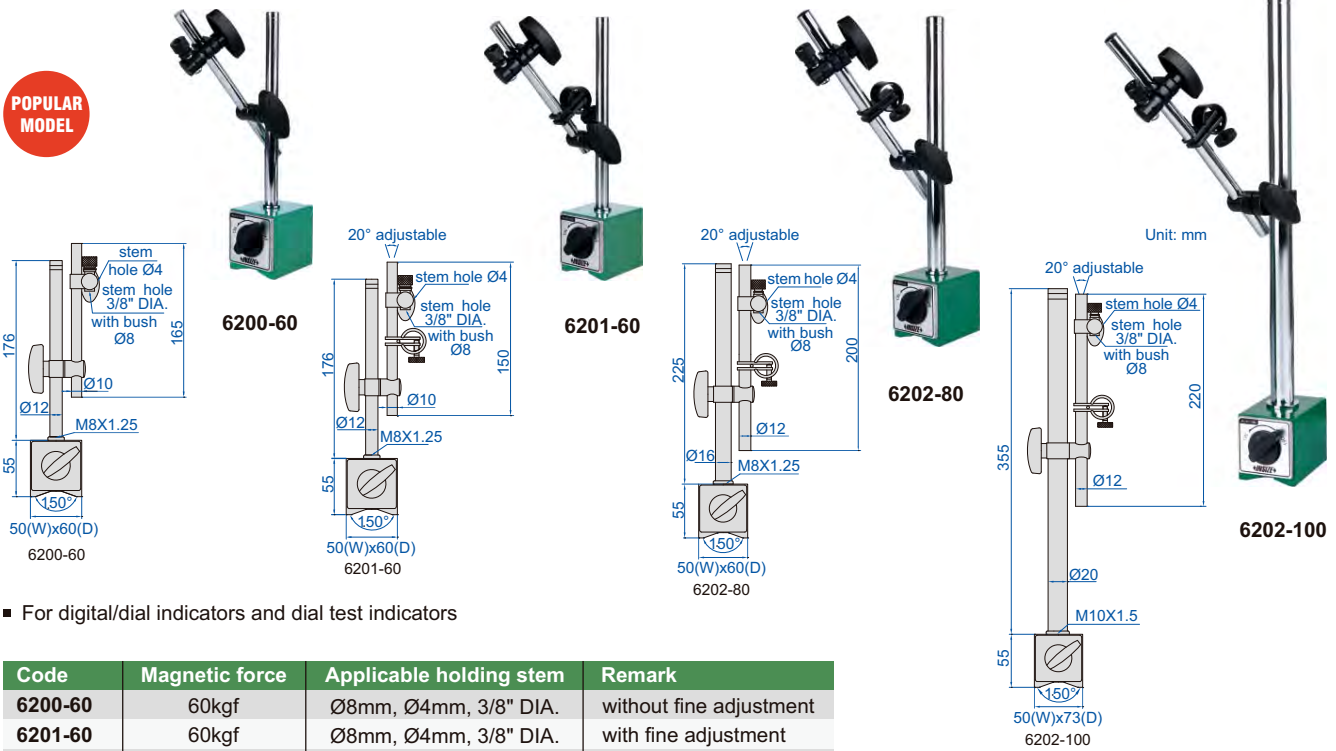

■ For digital/dial indicators and dial test indicators

Code	Magnetic force	Applicable holding stem	Remark
6200-60	60kgf	Ø8mm, Ø4mm, 3/8" DIA.	without fine adjustment
6201-60	60kgf	Ø8mm, Ø4mm, 3/8" DIA.	with fine adjustment
6202-80	80kgf	Ø8mm, Ø4mm, 3/8" DIA.	with fine adjustment
6202-100	100kgf	Ø8mm, Ø4mm, 3/8" DIA.	with fine adjustment

MAGNETIC STAND (FOR 0.001MM DIAL AND TEST INDICATORS)

■ For 0.001mm and 0.01mm dial and test indicators

Code	Magnetic force	Applicable holding stem	Remark
6221-80	80kgf	Ø8mm	with fine adjustment and dovetail groove

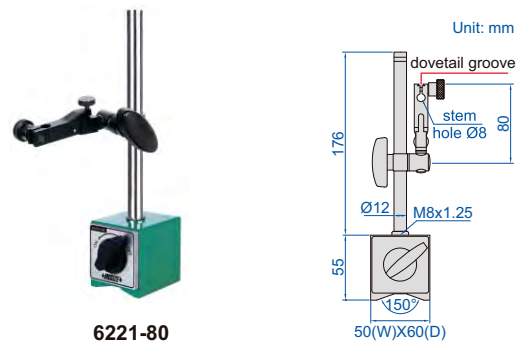

MAGNETIC STAND

■ For digital/dial indicators and dial test indicators

Code	Magnetic force	Applicable holding stem	Remark
6216-80	80kgf	Ø8mm	with fine adjustment and dovetail groove



MAGNETIC STAND FOR UNEVEN SURFACES

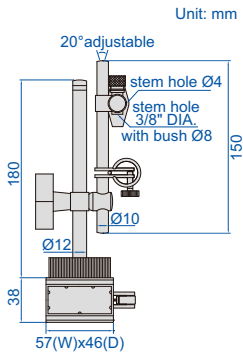

6215-60

- For digital/dial indicators and dial test indicators
- With fine adjustment

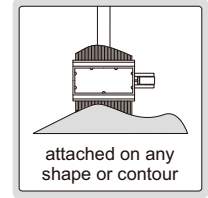

Code	Magnetic force	Applicable holding stem
6215-60	60kgf	Ø8mm, Ø4mm, 3/8" DIA.

MINI MAGNETIC STAND

10

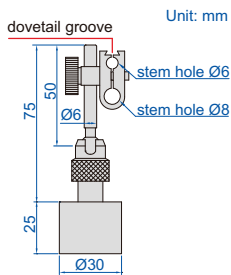

6211-10

ATTENTION: FOR DIAL TEST INDICATORS ONLY

- For dial test indicators
- With dovetail groove

Code	Magnetic force	Applicable holding stem
6211-10	10kgf	Ø6mm, Ø8mm

FLEX ARM MAGNETIC STAND

ATTENTION: FOR DIAL TEST INDICATORS ONLY

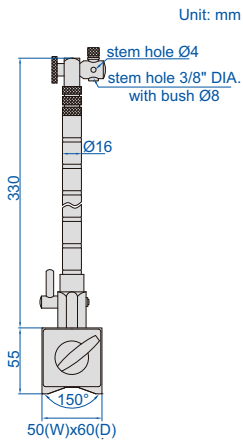

6207-80A

- For dial test indicators

Code	Magnetic force	Applicable holding stem
6207-80A	80kgf	Ø8mm, Ø4mm, 3/8" DIA.

MAGNETIC BASES



6212-80

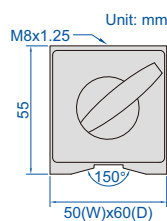

6212-80



6212-100

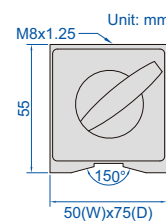

6212-100

Code	Magnetic force
6212-80	80kgf
6212-100	100kgf

VACUUM STAND

- Suitable for granite surface plates or cast iron surface plates
- For digital/dial indicators and dial test indicators

Code	Diameter of vacuum disc	Vacuum force	Applicable holding stem	Remark
6217-B	Ø80mm	80kgf	Ø8mm	with fine adjustment and dovetail groove



6217-B

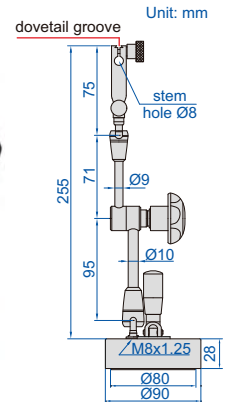

10

UNIVERSAL STAND

- For digital/dial indicators and dial test indicators
- With fine adjustment

Code	Applicable holding stem
6214-A	Ø8mm, Ø4mm, 3/8" DIA.



6214-A

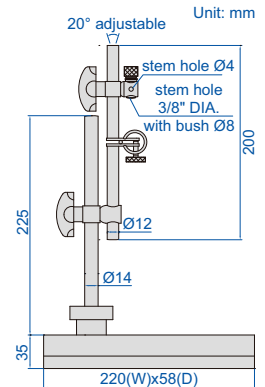

DIAL INDICATOR STANDS (NON-MAGNETIC)

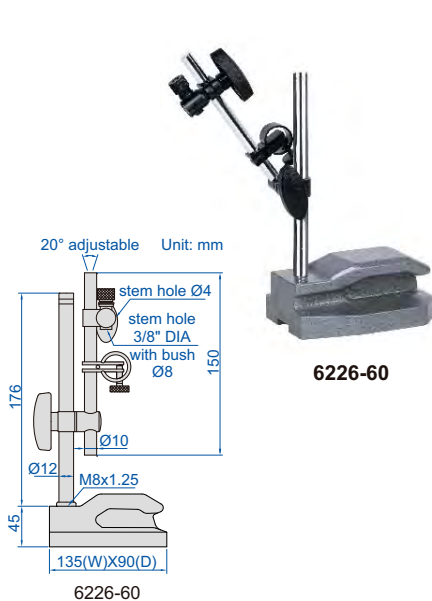

6226-60

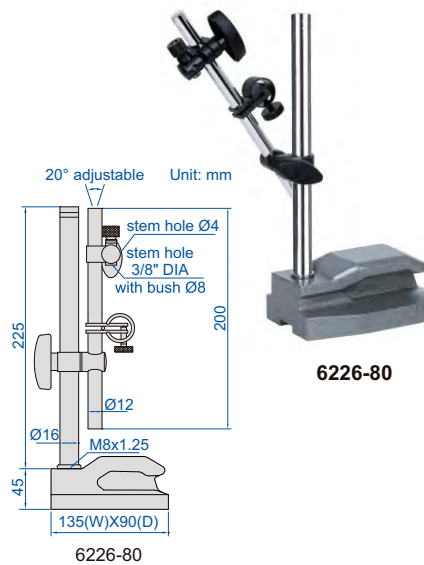

6226-80

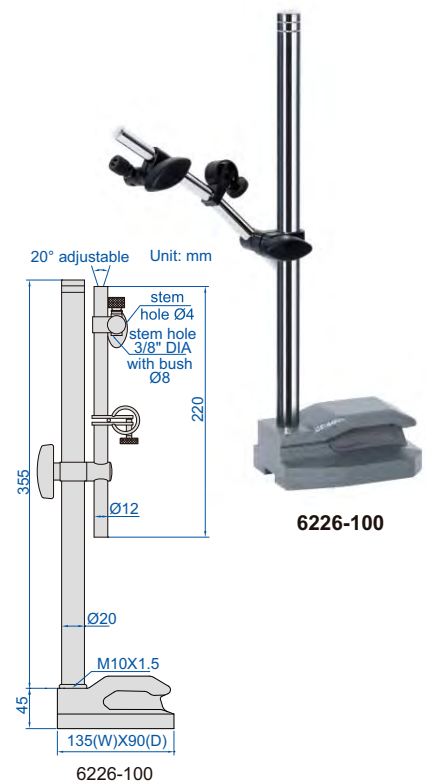

6226-100

Code	Applicable holding stem	Remark
6226-60	Ø8mm, Ø4mm, 3/8" DIA	with fine adjustment
6226-80	Ø8mm, Ø4mm, 3/8" DIA	with fine adjustment
6226-100	Ø8mm, Ø4mm, 3/8" DIA	with fine adjustment

- Hardened base
- Suitable for granite surface plates and cast iron surface plates
- For digital/dial indicators and dial test indicators

DIAL INDICATOR STAND (FOR 0.001MM DIAL AND TEST INDICATORS)

- Non-magnetic and hardened base
- Suitable for granite surface plates or cast iron surface plates
- For 0.001mm and 0.01mm dial and test indicators



6230-60

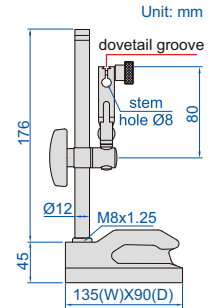

Code	Applicable holding stem	Remark
6230-60	Ø8mm	with fine adjustment and dovetail groove

DIAL INDICATOR STAND (NON-MAGNETIC)

10

- Hardened base
- Suitable for granite surface plates and cast iron surface plates
- For digital/dial indicators and dial test indicators

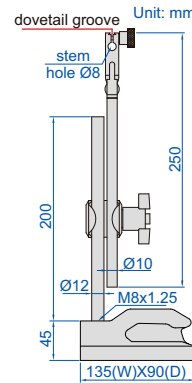

6227-80

Code	Applicable holding stem	Remark
6227-80	Ø8mm	with fine adjustment and dovetail groove

UNIVERSAL DIAL INDICATOR STANDS (NON-MAGNETIC)

- Hardened base
- Suitable for granite surface plates and cast iron surface plates
- For digital/dial indicators and dial test indicators



6225-80

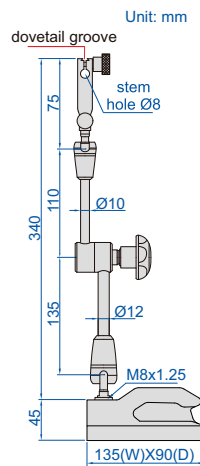

6225-80



6225-100

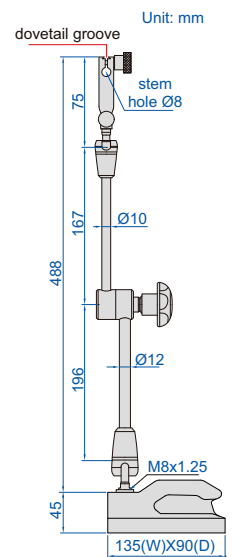

6225-100

Code	Applicable holding stem	Remark
6225-80	Ø8mm	with fine adjustment and dovetail groove
6225-100	Ø8mm	with fine adjustment and dovetail groove

DIAL INDICATOR STANDS

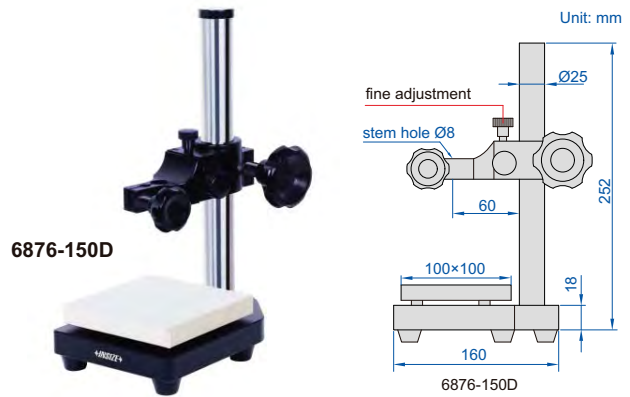
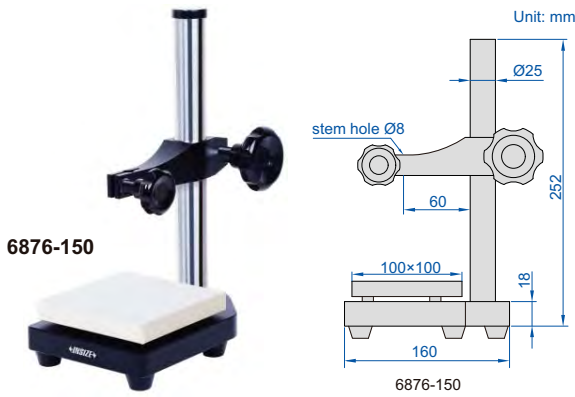

Code	Applicable holding stem	Anvil	Remark
6876-150	Ø8mm	ceramic, plain, flatness 1.5µm	without fine adjustment
6876-150D	Ø8mm	ceramic, plain, flatness 1.5µm	with fine adjustment, fine adjustment range 3mm

- Vertical travel of holder: 150mm
- Ceramic anvil
- Supplied with dust cover

10

GRANITE DIAL INDICATOR STANDS (BASIC TYPE)

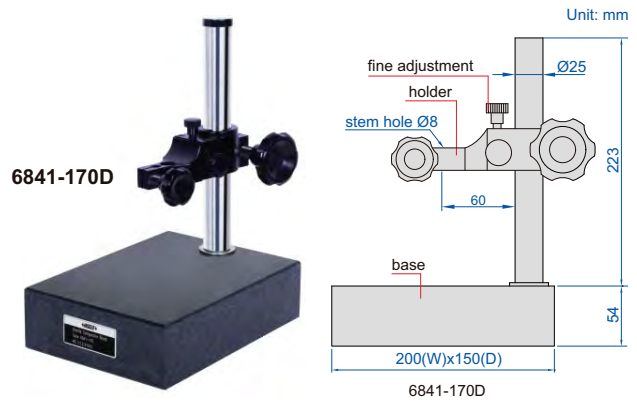
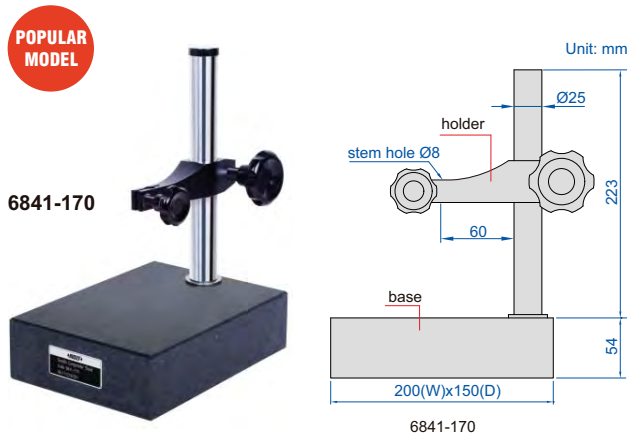

Code	Applicable holding stem	Base	Remark
6841-170	Ø8mm	flatness 2.5µm	without fine adjustment
6841-170D	Ø8mm	flatness 2.5µm	with fine adjustment, fine adjustment range 3mm

- Vertical travel of holder: 170mm
- Supplied with dust cover

GRANITE DIAL INDICATOR STAND

- Vertical travel of holder: 150mm
- Fine adjustment range: 2mm
- Supplied with dust cover

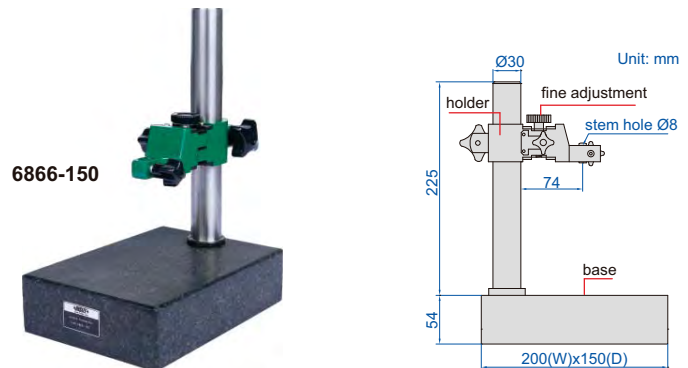

Code	Applicable holding stem	Base
6866-150	Ø8mm	flatness 2.5µm

DATA
OUTPUT

DIGITAL GROOVE MEASUREMENT STANDS

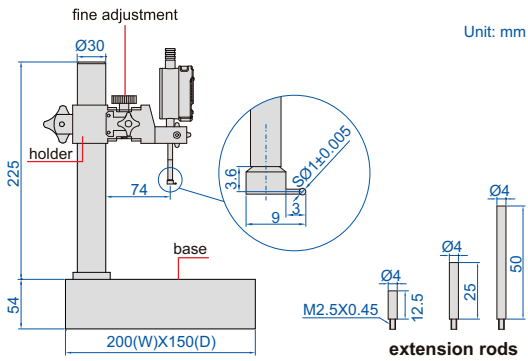

6870-150

- Button function: on/off, zero, mm/inch, measuring direction change, data preset, absolute/incremental measurement
- Vertical travel of holder: 150mm
- Fine adjustment range: 2mm
- CR2032 battery, automatic power off (time is adjustable)
- Data output
- Supplied with extension rods: 12.5mm (1 pc), 25mm (1 pc), 50mm (1 pc)
- Supplied with groove point and dust cover
- Optional accessory: data output cable (code 7315-50M page 5, 7302-40M page 13)

measure width (b) and depth (a) of groove

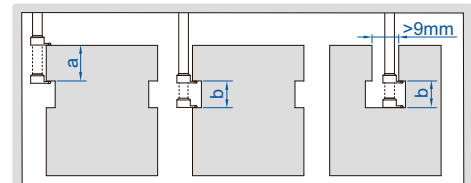

Code	Digital indicator stroke	Digital indicator resolution	Accuracy	Applicable holding stem	Base
6870-150	12.7mm/0.5"	0.01mm/0.0005"	±20µm	Ø8mm	flatness 2.5µm
6870-1501	12.7mm/0.5"	0.001mm/0.00005"	±5µm	Ø8mm	flatness 2.5µm

10

GRANITE DIAL INDICATOR STANDS

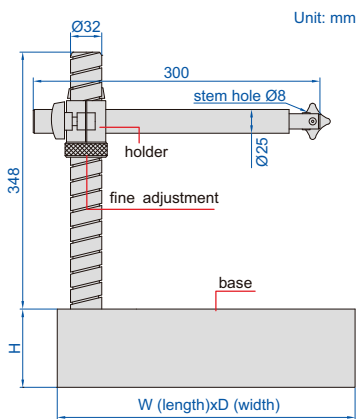

6867-250



6867-400

- Vertical travel of holder: 250mm
- Fine adjustment range: entire stroke
- Supplied with dust cover

Code	Applicable holding stem	W	D	H	Base
6867-250	Ø8mm	300mm	300mm	75mm	flatness 2.8µm
6867-400	Ø8mm	400mm	300mm	100mm	flatness 3µm

DIAL INDICATOR STANDS

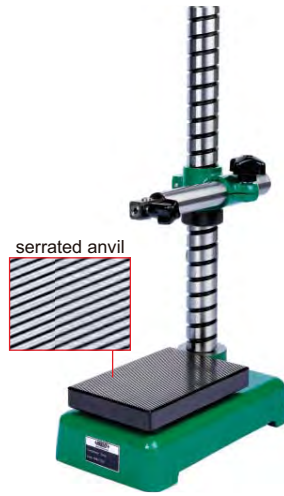
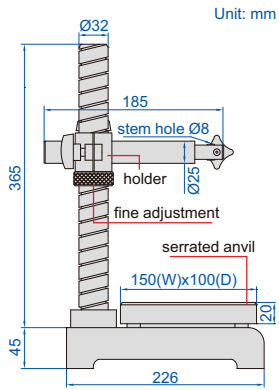

6864-250

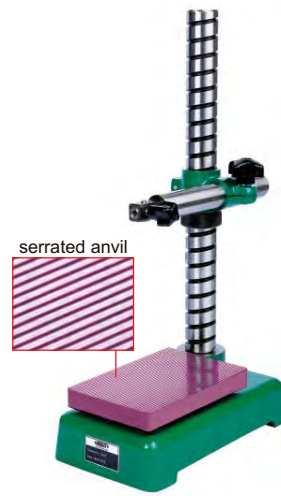

6864-250T

- Vertical travel of holder: 250mm
- Fine adjustment range: entire stroke
- Supplied with dust cover

Code	Applicable holding stem	Anvil
6864-250	Ø8mm	steel (hardness HRC60±2), serrated, flatness 1.5µm
6864-250T	Ø8mm	ceramic, serrated, flatness 1.5µm

DIAL INDICATOR STANDS

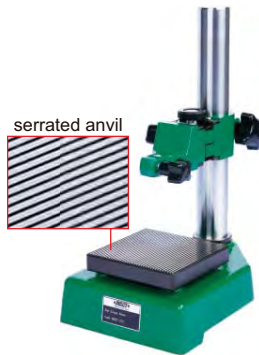
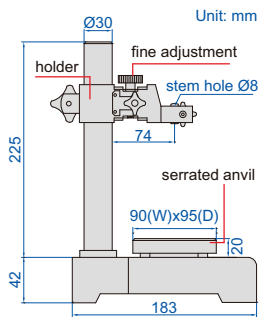

6863-150

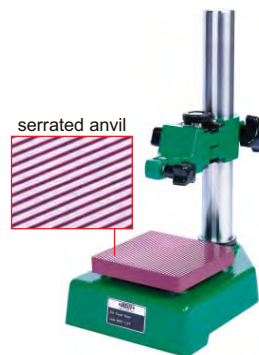

6863-150T

- Vertical travel of holder: 150mm
- Fine adjustment range: 2mm
- Supplied with dust cover

Code	Applicable holding stem	Anvil
6863-150	Ø8mm	steel (hardness HRC60±2), serrated, flatness 1.5µm
6863-150T	Ø8mm	ceramic, serrated, flatness 1.5µm

DIAL INDICATOR STANDS



6862-1001



6862-1002

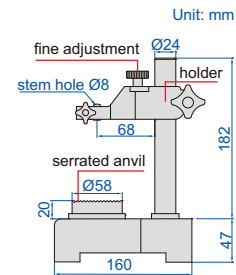

6862-1001
6862-1001T

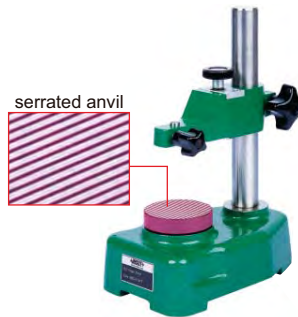

6862-1001T



6862-1002T

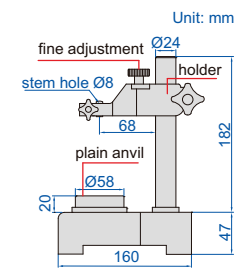

6862-1002
6862-1002T

Code	Applicable holding stem	Anvil
6862-1001	Ø8mm	steel (hardness HRC60±2), serrated, flatness 1.5µm
6862-1002	Ø8mm	steel (hardness HRC60±2), plain, flatness 1.5µm
6862-1001T	Ø8mm	ceramic, serrated, flatness 1.5µm
6862-1002T	Ø8mm	ceramic, plain, flatness 1.5µm

- Vertical travel of holder: 100mm
- Fine adjustment range: 2mm
- Supplied with dust cover

HEAVY DUTY DIAL INDICATOR STAND

- Vertical travel of holder: 300mm
- Fine adjustment range: 5mm
- Carbide base
- Supplied with dust cover
- Optional accessory:
holder with stem hole Ø28 (code 6869-D28)

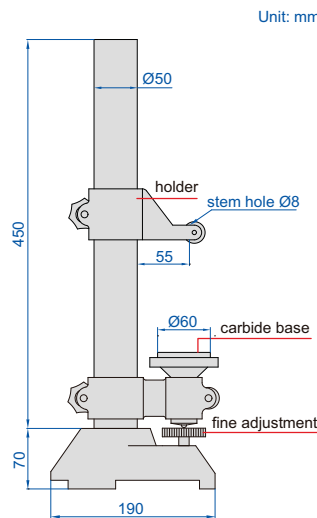

6869-300

Code	Applicable holding stem	Base
6869-300	Ø8mm	plain, flatness 1µm, carbide

DIAL INDICATOR STAND

GAGE BLOCKS ARE NEEDED FOR ZERO SETTING



digital/dial indicator is optional

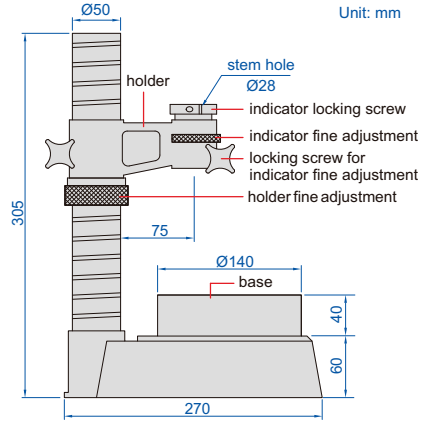

6842-150



locating fork for workpiece (included)



rotary lever probe (included)



base with step (included)



- Vertical travel of holder: 180mm
- Holder fine adjustment range: entire stroke
- Indicator fine adjustment range: 10mm
- Optional accessory: Ø28mm/Ø8mm bush (code **6843-B8**), 0.001mm digital/dial indicators, high precision digital indicators (code **2140-6**, **2140-6WL**), gage blocks (**4101** series, for zero setting)

the tip of rotary lever probe can reach narrow areas

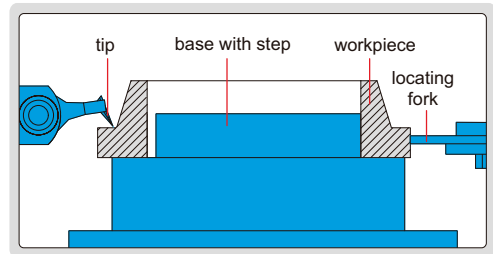

Code	Applicable holding stem	Base
6842-150	Ø28mm	flatness 2µm

Ø28mm/Ø8mm bush (optional)



Code
6843-B8

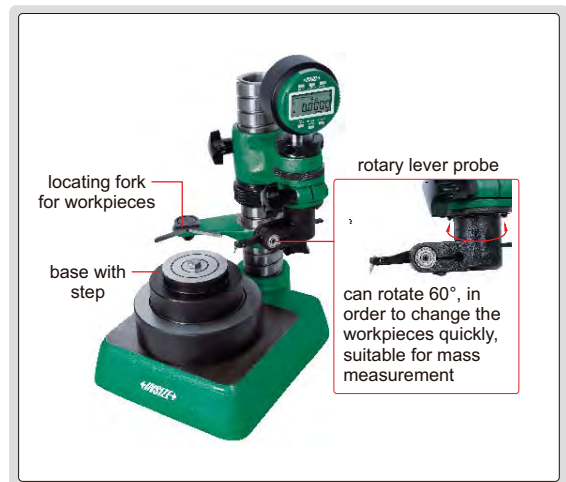

GAGE BLOCKS ARE NEEDED FOR ZERO SETTING

locating fork for workpieces (included)

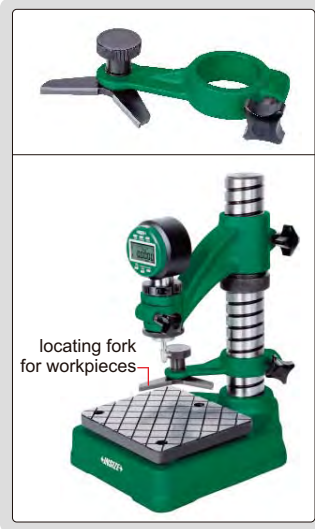

digital/dial indicator is optional



6846-140

DIAL INDICATOR STAND

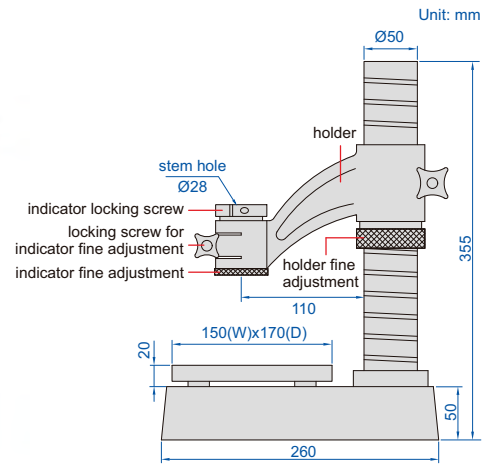

Unit: mm

Ø28mm/Ø8mm bush (optional)



Code
6843-B8

application



- Vertical travel of holder: 140mm
- Holder fine adjustment range: entire stroke
- Indicator fine adjustment range: 3mm
- Optional accessory: Ø28mm/Ø8mm bush (code 6843-B8), 0.001mm digital/dial indicators, high precision digital indicators (code 2140-6, 2140-6WL), gage blocks (4101 series, for zero setting)

Code	Applicable holding stem	Anvil
6846-140	Ø28mm	grid, flatness 1µm

GAGE BLOCKS ARE NEEDED FOR ZERO SETTING

locating fork for workpieces (included)



digital/dial indicator is optional



6845-100

DIAL INDICATOR STAND

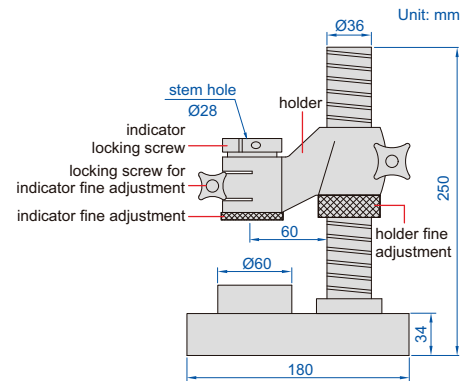

Unit: mm

Ø28mm/Ø8mm bush (optional)



Code
6843-B8

application



- Vertical travel of holder: 100mm
- Holder fine adjustment range: entire stroke
- Indicator fine adjustment range: 3mm
- Optional accessory: Ø28mm/Ø8mm bush (code 6843-B8), 0.001mm digital/dial indicators, high precision digital indicators (code 2140-6, 2140-6WL), gage blocks (4101 series, for zero setting)

Code	Applicable holding stem	Anvil
6845-100	Ø28mm	serrated, flatness 1µm

TRANSFER STANDS

application



rigid construction, designed to make comparison height measurement (set zero with gage block then measure height of workpiece) with dial indicators or digital indicators (variation of measuring force is high)



6865-300



6865-300T

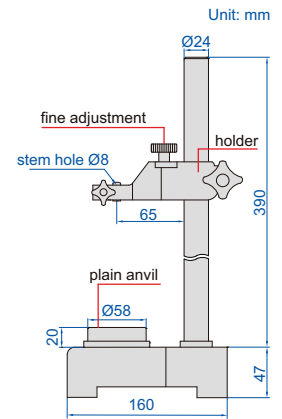

- Vertical travel of holder: 335mm
- Fine adjustment range: 2mm
- Supplied with dust cover

Code	Applicable holding stem	Anvil
6865-300	Ø8mm	steel (hardness HRC60±2), plain, flatness 1.5µm
6865-300T	Ø8mm	ceramic, plain, flatness 1.5µm

DIGITAL HEIGHT GAGES

REFER TO PAGE 81-83 FOR DETAILS



1155-505



1157-501



1158-100



Internal Caliper Gages
Page 248-251



External Caliper Gages
Page 252-253



Thickness Gages
Page 254-257



Rubber Thickness Gages
Page 258



Tube Thickness Gages
Page 259-260



Snap Gages
Page 260-263



Step And Gap Gages
Page 264



Mini Digital Height Gages
Page 264



Height Gages
Page 265



Crankshaft Testers
Page 266



Keyway Gages
Page 266-267

DIGITAL INTERNAL CALIPER GAGES

DATA
OUTPUT



2121-15

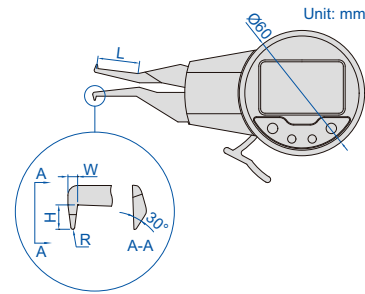

11

- Resolution: 0.005mm/0.0002"
- Reading in digit and analog
- Display can be rotated by 170°
- Button function: tolerance Go and No-Go display, data preset, max./min. measurement, data holding, inch/metric conversion, absolute/incremental measurement
- CR2032 battery, automatic power off
- Data output
- Optional accessory: data output cable (code 7315-30 page 4, 7302-30 page 12)

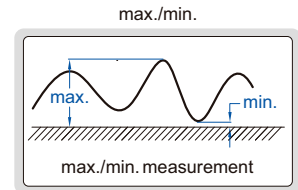
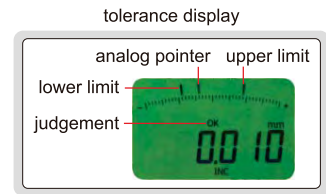
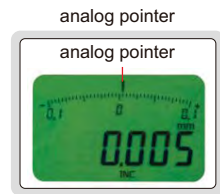

Code	Range	Accuracy	Repeatability	L	H	W	R
2121-15	5-15mm/0.2-0.6"	±0.03mm	0.01mm	20	2	1.5	R0.3
2121-25	5-25mm/0.2-1.0"	±0.03mm	0.01mm	35	1.5	1.0	R0.3
2121-31	10-30mm/0.4-1.2"	±0.03mm	0.01mm	55	5.5	2.5	R0.5
2121-41	20-40mm/0.8-1.6"	±0.03mm	0.01mm	80	6.0	3.0	R0.5
2121-51	30-50mm/1.2-2.0"	±0.03mm	0.01mm	80	8.0	3.0	R0.5
2121-61	40-60mm/1.6-2.4"	±0.03mm	0.01mm	80	8.0	3.0	R0.5

INTERNAL DIAL CALIPER GAGES



2222-15

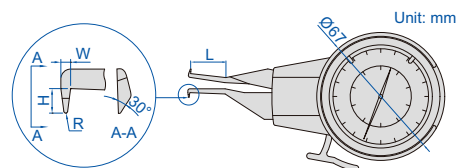

Code	Range	Graduation	Accuracy	L	H	W	R
2222-15	5-15mm	0.01mm	±0.03mm	20	2	1.5	R0.3
2222-25	5-25mm	0.01mm	±0.03mm	35	1.5	1.0	R0.3
2222-301	10-30mm	0.01mm	±0.03mm	55	5.5	2.5	R0.5
2222-401	20-40mm	0.01mm	±0.03mm	80	6.0	3.0	R0.5
2222-501	30-50mm	0.01mm	±0.03mm	80	8.0	3.0	R0.5
2222-60	40-60mm	0.01mm	±0.03mm	80	8.0	3.0	R0.5

DATA OUTPUT

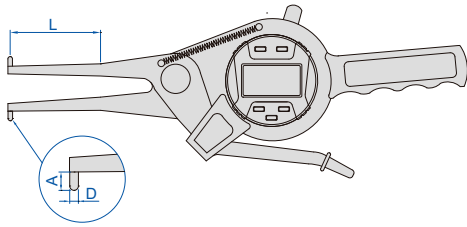

DIGITAL INTERNAL CALIPER GAGES



2151-35

- Carbide measuring tips
- Reading in digit and analog
- With transmission button and signal light
- Display can be rotated by 320°
- Button function: on/off, zero, tolerance Go and No-Go display, data preset, measuring direction change, max./min./TIR measurement, inch/metric conversion, data output, absolute/incremental measurement
- CR2032 battery, automatic power off (time is adjustable)
- Data output
- Optional accessory: data output cable (code 7315-50M page 5, 7302-50M page 13)

(mm)

Code	Range	Resolution	Accuracy	L	A	D
2151-35	15-35mm/0.6-1.4"	0.01mm/0.0005"	±0.04mm	50	3	Ø3
2151-AL35	15-35mm/0.6-1.4"	0.01mm/0.0005"	±0.04mm	200	3	Ø3
2151-55	35-55mm/1.4-2.2"	0.01mm/0.0005"	±0.04mm	80	6	Ø3
2151-AL55	35-55mm/1.4-2.2"	0.01mm/0.0005"	±0.04mm	250	8	Ø3
2151-75	55-75mm/2.2-3"	0.01mm/0.0005"	±0.04mm	90	8	Ø3
2151-AL75	55-75mm/2.2-3"	0.01mm/0.0005"	±0.04mm	250	8	Ø3
2151-95	75-95mm/3-3.8"	0.01mm/0.0005"	±0.04mm	100	8	Ø3
2151-115	95-115mm/3.8-4.6"	0.01mm/0.0005"	±0.04mm	120	10	Ø3.2
2151-135	115-135mm/4.6-5.4"	0.01mm/0.0005"	±0.04mm	120	10	Ø3.2

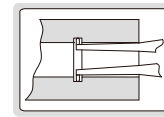

INTERNAL DIAL CALIPER GAGES

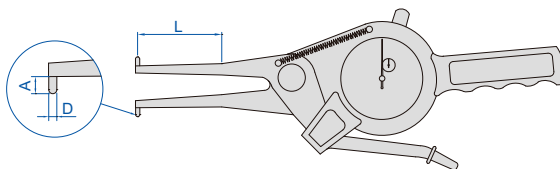

2321-35

- Carbide measuring tips

(mm)

Code	Range	Graduation	Accuracy	L	A	D
2321-35	15-35mm	0.01mm	±0.04mm	50	3	Ø3
2321-AL35	15-35mm	0.01mm	±0.04mm	200	3	Ø3
2321-55	35-55mm	0.01mm	±0.04mm	80	6	Ø3
2321-AL55	35-55mm	0.01mm	±0.04mm	250	8	Ø3
2321-75	55-75mm	0.01mm	±0.04mm	90	8	Ø3
2321-AL75	55-75mm	0.01mm	±0.04mm	250	8	Ø3
2321-95	75-95mm	0.01mm	±0.04mm	100	8	Ø3
2321-115	95-115mm	0.01mm	±0.04mm	120	10	Ø3.2
2321-135	115-135mm	0.01mm	±0.04mm	120	10	Ø3.2

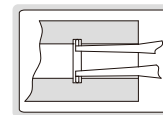

LARGE RANGE INTERNAL DIAL CALIPER GAGES



2334-155

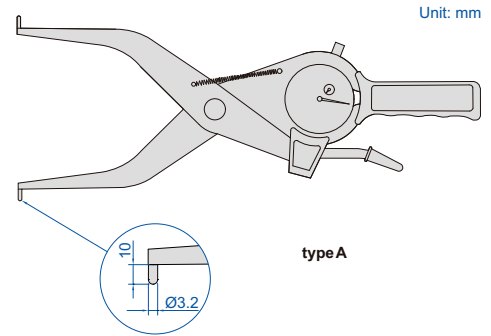

11

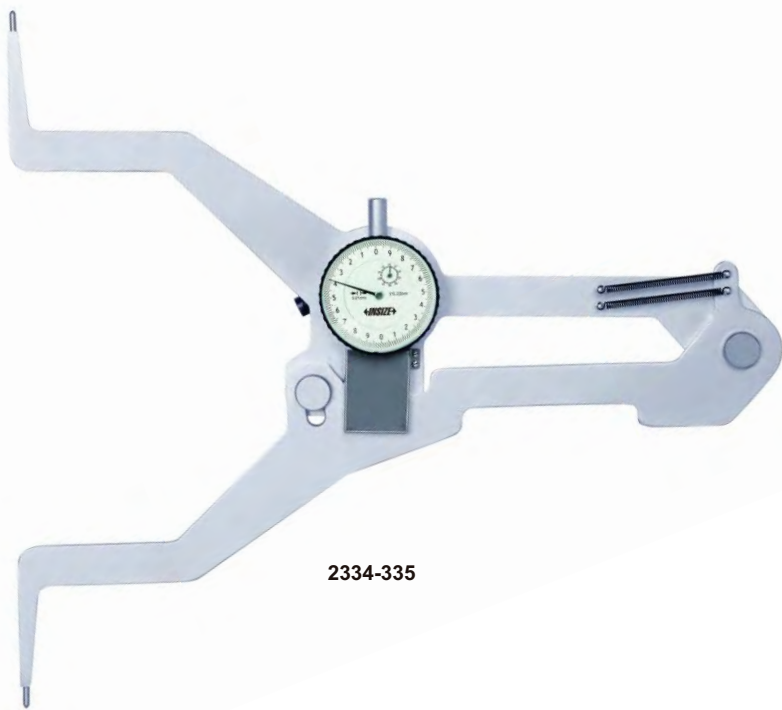

2334-335

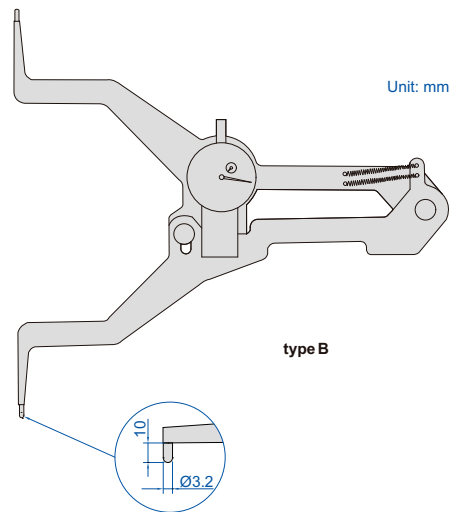

■ Carbide measuring tips

Code	Range	Graduation	Accuracy	Type	L (mm)
2334-155	135-155mm	0.01mm	±0.04mm	A	<200
2334-175	155-175mm	0.01mm	±0.04mm	A	<200
2334-195	175-195mm	0.01mm	±0.04mm	A	<200
2334-215	195-215mm	0.01mm	±0.04mm	A	<200
2334-235	215-235mm	0.01mm	±0.04mm	A	<200
2334-255	235-255mm	0.01mm	±0.04mm	A	<200
2334-275	255-275mm	0.01mm	±0.04mm	A	<200
2334-295	275-295mm	0.01mm	±0.04mm	A	<200
2334-315	295-315mm	0.01mm	±0.04mm	A	<200
2334-335	315-335mm	0.01mm	±0.04mm	B	<200
2334-355	335-355mm	0.01mm	±0.04mm	B	<200
2334-375	355-375mm	0.01mm	±0.04mm	B	<200

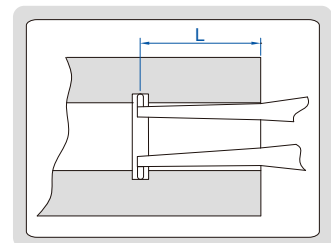

INTERNAL DIAL CALIPER GAGE WITH INTERCHANGEABLE POINTS



2223-153

Unit: mm

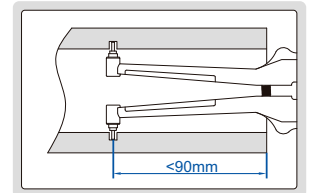
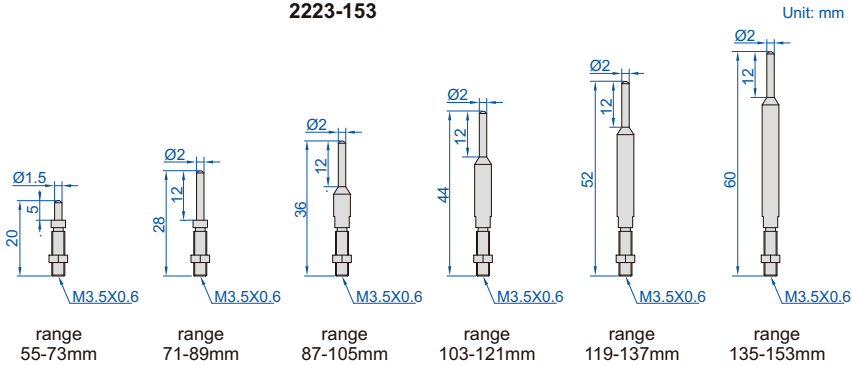
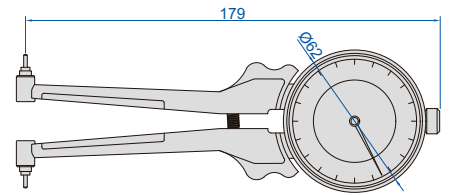

6 pair of points (included)



- Supplied with 6 pairs of points

Code	Range	Dial indicator range	Graduation	Accuracy
2223-153	55-153mm	2mm	0.01mm	±0.02mm

DIGITAL INTERNAL CALIPER GAGES (ECONOMIC TYPE)



2711-165

Unit: mm

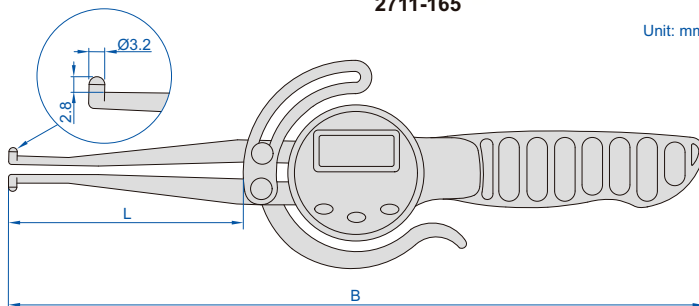

sizes to be measured

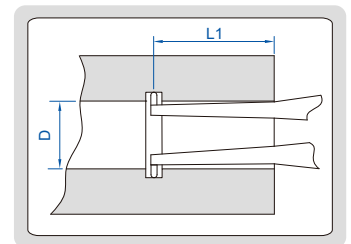

- Button function: on/off, zero, mm/inch, data hold
- Battery CR2032, automatic power off

(mm)

Code	Range	Resolution	Accuracy	Repeatability	L	B
2711-165	12.7-165mm/0.5-6.5"	0.1mm/0.01"	±0.3mm	0.2mm	85	252
2711-216	12.7-216mm/0.5-8.5"	0.1mm/0.01"	±0.3mm	0.2mm	160	327

(mm)

Code 2711-165	D	L1
Ø13	<42	
Ø15	<45	
Ø17	<50	
Ø20	<60	
Ø25	<75	
Ø27	<80	
Ø29~165	<85	

(mm)

Code 2711-216	D	L1
Ø13	<50	
Ø15	<55	
Ø17	<60	
Ø20	<65	
Ø25	<75	
Ø30	<95	
Ø35~216	<160	

DIGITAL EXTERNAL CALIPER GAGES

DATA
OUTPUT

- Resolution: 0.005mm/0.0002"
- Reading in digit and analog
- Display can be rotated by 170°
- Button function: tolerance Go and No-Go display, data preset, max./min. measurement, data holding, inch/metric conversion, absolute/incremental measurement
- CR2032 battery, automatic power off
- Data output
- Optional accessory: data output cable (code 7315-30 page 4, 7302-30 page 12)



2131-21

11

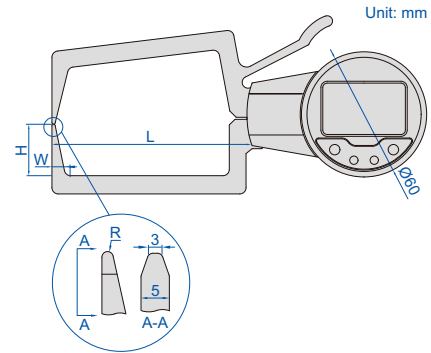
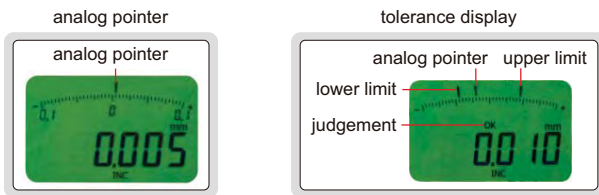

Code	Range	Accuracy	Repeatability	L	H	W	R
2131-21	0-20mm/0-0.8"	±0.03mm	0.01mm	80mm	25mm	6.5mm	R0.5mm
2131-31	10-30mm/0.4-1.2"	±0.03mm	0.01mm	80mm	25mm	6.5mm	R0.5mm
2131-41	20-40mm/0.8-1.6"	±0.03mm	0.01mm	80mm	25mm	6.5mm	R0.5mm
2131-51	30-50mm/1.2-2.0"	±0.03mm	0.01mm	80mm	25mm	6.5mm	R0.5mm
2131-61	40-60mm/1.6-2.4"	±0.03mm	0.01mm	80mm	25mm	6.5mm	R0.5mm

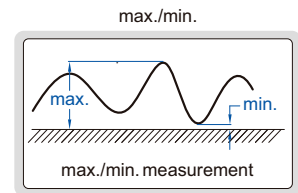

EXTERNAL DIAL CALIPER GAGES

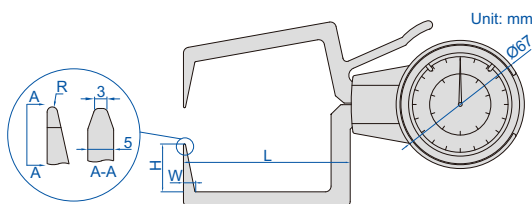

2333-201

(mm)

Code	Range	Graduation	Accuracy	L	H	W	R
2333-201	0-20mm	0.01mm	±0.03mm	80	25	6.5	R0.5
2333-301	10-30mm	0.01mm	±0.03mm	80	25	6.5	R0.5
2333-401	20-40mm	0.01mm	±0.03mm	80	25	6.5	R0.5
2333-501	30-50mm	0.01mm	±0.03mm	80	25	6.5	R0.5
2333-601	40-60mm	0.01mm	±0.03mm	80	25	6.5	R0.5

DATA OUTPUT

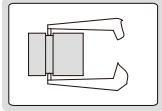

- Carbide measuring tips
- Reading in digit and analog
- With transmission button and signal light
- Display can be rotated by 320°
- Button function: on/off, zero, tolerance Go and No-Go display, data preset, measuring direction change, max./min./TIR measurement, inch/metric conversion, absolute/incremental measurement, data output
- CR2032 battery, automatic power off (time is adjustable)
- Data output
- Optional accessory: data output cable (code **7315-50M** page 5, **7302-50M** page 13)

DIGITAL EXTERNAL CALIPER GAGES



2132-20

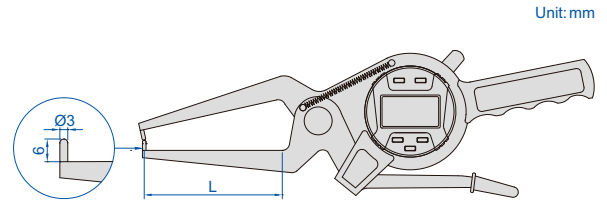

Unit: mm

Code	Range	Resolution	Accuracy	L (mm)
2132-20	0-20mm/0-0.8"	0.01mm/0.0005"	±0.04mm	60
2132-40	20-40mm/0.8-1.6"	0.01mm/0.0005"	±0.04mm	60
2132-60	40-60mm/1.6-2.4"	0.01mm/0.0005"	±0.04mm	55
2132-80	60-80mm/2.4-3.2"	0.01mm/0.0005"	±0.04mm	55
2132-100	80-100mm/3.2-4"	0.01mm/0.0005"	±0.04mm	55

EXTERNAL DIAL CALIPER GAGES

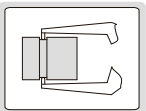

- Carbide measuring tips



2332-20

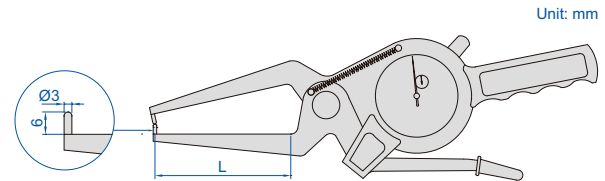

Unit: mm

Code	Range	Graduation	Accuracy	L (mm)
2332-20	0-20mm	0.01mm	±0.04mm	60
2332-40	20-40mm	0.01mm	±0.04mm	60
2332-60	40-60mm	0.01mm	±0.04mm	55
2332-80	60-80mm	0.01mm	±0.04mm	55
2332-100	80-100mm	0.01mm	±0.04mm	55

DIGITAL THICKNESS GAGES

POPULAR MODEL

DATA OUTPUT

- Ceramic spindle tip and anvil
- Button function: on/off, inch/mm, zero, data preset, change measuring direction, absolute/incremental measurement
- Keep preset data in memory after restart
- CR2032 battery, automatic power off (time is adjustable)
- Data output
- Optional accessory: data output cable (code **7315-50M** page 5, **7302-50M** page 13)

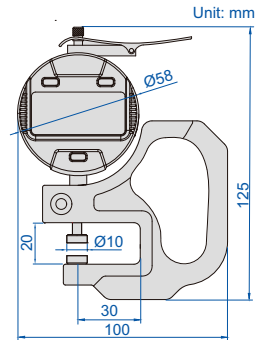

2871-101

Code	Range	Resolution	Accuracy
2871-10	0-10mm/0-0.4"	0.01mm/0.0005"	±0.02mm
2871-101	0-10mm/0-0.4"	0.001mm/0.00005"	±0.005mm

11

THICKNESS GAGES

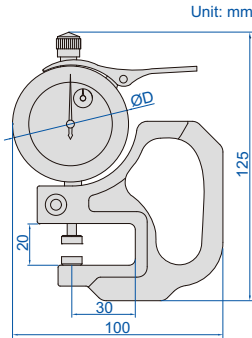
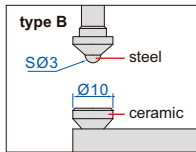
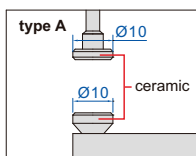

2364-10



2364-1

Code	Range	Graduation	Accuracy	Type	ØD
2364-10	0-10mm	0.01mm	±0.02mm	A	58mm
2364-10B	0-10mm	0.01mm	±0.02mm	B	58mm
2364-1	0-1mm	0.001mm	±0.005mm	A	56mm

THICKNESS GAGES

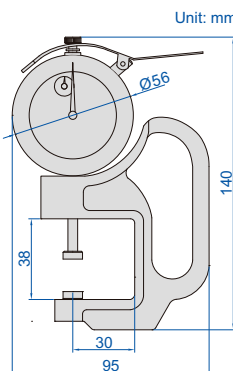
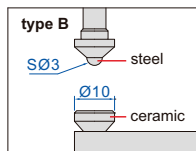
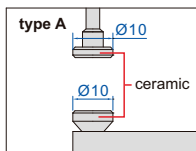

2366-30

Code	Range	Graduation	Accuracy	Type
2366-30	0-30mm	0.01mm	±0.035mm	A
2366-30B	0-30mm	0.01mm	±0.035mm	B

DATA OUTPUT

measuring tips and anvils can be custom-made

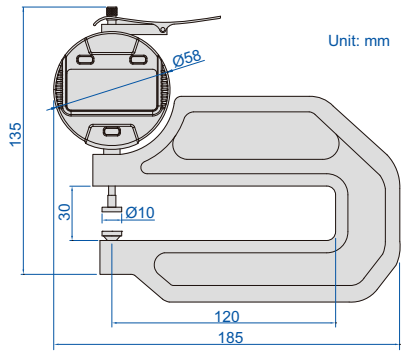

Unit: mm

DIGITAL THICKNESS GAGES



2872-10

- Ceramic spindle tip and anvil
- Buttons: on/off, inch/mm, zero, data preset, change measuring direction, absolute/incremental measurement
- Keep preset data in memory after restart
- Battery CR2032, automatic power off (time is adjustable)
- Data output
- Optional accessory: data output cable (code 7315-50M page 5, 7302-50M page 13)

Code	Range	Resolution	Accuracy
2872-10	0-10mm/0-0.4"	0.01mm/0.0005"	±0.02mm
2872-101	0-10mm/0-0.4"	0.001mm/0.00005"	±0.01mm

THICKNESS GAGES

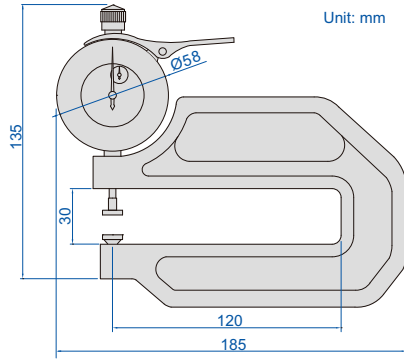
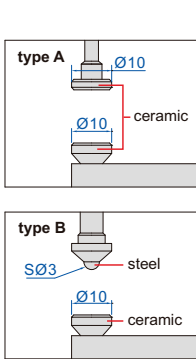

Unit: mm

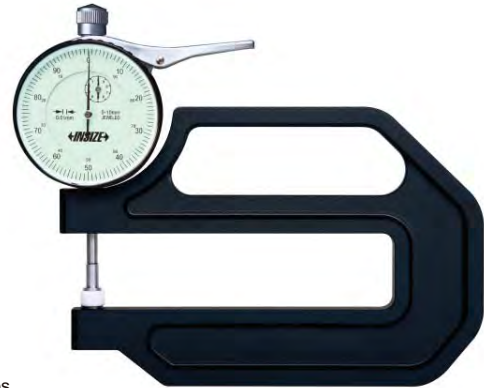

2365-10

measuring tips and anvils can be custom-made



Code	Range	Graduation	Accuracy	Type
2365-10	0-10mm	0.01mm	±0.02mm	A
2365-20	0-20mm	0.01mm	±0.03mm	A
2365-10B	0-10mm	0.01mm	±0.02mm	B
2365-20B	0-20mm	0.01mm	±0.03mm	B

SUITABLE FOR JEWELLERY

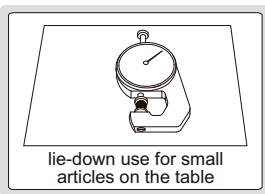

lie-down use for small articles on the table

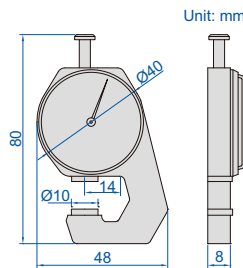

Unit: mm



2361-10

THICKNESS GAGE

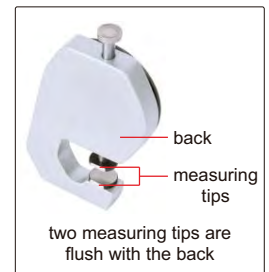

back
measuring tips

two measuring tips are flush with the back

Code	Range	Graduation	Accuracy
2361-10	0-10mm	0.1mm	±0.05mm

THICKNESS GAGE

- Stainless steel spindle tip and anvil

Code	Range	Graduation	Accuracy
2363-10	0-10mm	0.01mm	±0.03mm



2363-10

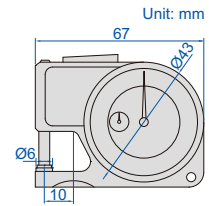

DIGITAL ROLLER THICKNESS GAGES

DATA OUTPUT



2877-4



2877-10

- Buttons: on/off, inch/mm, zero, data preset, change measuring direction, absolute/incremental measurement
- Keep preset data in memory after restart
- Battery CR2032, automatic power off (time is adjustable)
- Data output
- Optional accessory: data output cable (code 7315-50M page 5, 7302-50M page 13)

Code	Range	Resolution	Accuracy
2877-4	0-4.5mm/0-0.18"	0.01mm/0.0005"	±0.02mm
2877-41	0-4.5mm/0-0.18"	0.001mm/0.00005"	±0.01mm
2877-10	0-10mm/0-0.4"	0.01mm/0.0005"	±0.02mm
2877-101	0-10mm/0-0.4"	0.001mm/0.00005"	±0.01mm

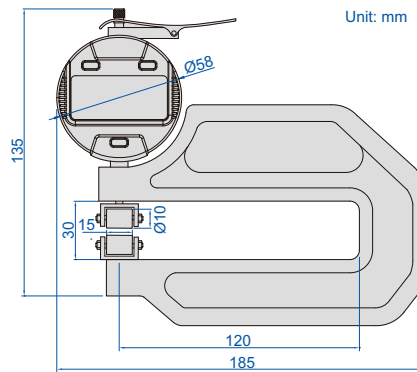

2877-4/2877-41

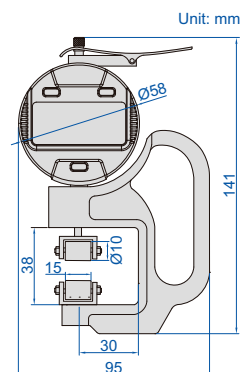

2877-10/2877-101

HIGH PRECISION DIGITAL THICKNESS GAGES

MEASURING TIPS AND ANVILS CAN BE CUSTOM-MADE

ABSOLUTE ENCODER, THE ORIGINAL DATA REMAINS AFTER POWER OFF

ATTENTION: RECHARGEABLE BATTERY, FOR 12 HOURS CONTINUOUS WORKING

DATA OUTPUT

- Absolute encoder, the original data remains after power off
- Button function: on/off, zero, tolerance, absolute/incremental measurement, max./min./TIR, data preset, mm/inch, data output, data hold
- Measuring force: 0.5-1N
- Reading in digital and analog
- Power: rechargeable battery, for 12 hours continuous working
- Data output
- Supplied with data output cable (keyboard format)

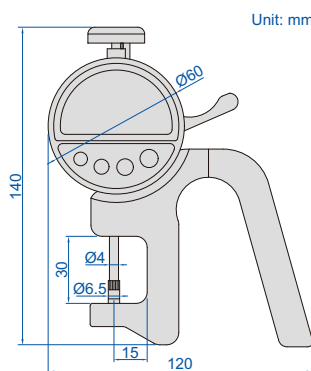

2879-10

Code	Range	Resolution	Accuracy	Repeatability
2879-10	0-10mm/0-0.4"	0.001mm/0.00005"	±0.002mm	0.001mm
2879-101	0-10mm/0-0.4"	0.0005mm/0.00002"	±0.0015mm	0.0005mm

THICKNESS GAGES

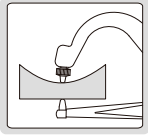

Code	Range	Graduation	Accuracy	L	L1
2862-101	0-10mm	0.05mm	±0.1mm	35mm	85mm
2862-102	0-10mm	0.05mm	±0.1mm	60mm	110mm



2862-101

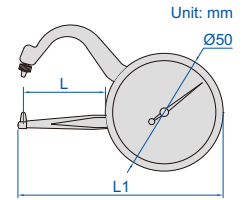

THICKNESS GAGE

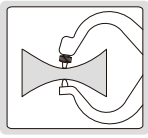

Code	Range	Graduation	Accuracy
2863-10	0-10mm	0.05mm	±0.1mm



2863-10

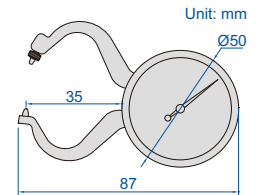

THICKNESS GAGE WITH POINTED TIPS

- Pointed tips fit into small grooves and recesses

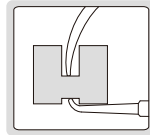

Code	Range	Graduation	Accuracy
2866-10	0-10mm	0.05mm	±0.1mm



2866-10

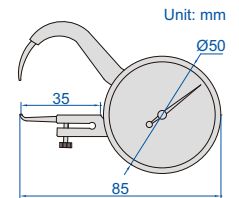

THICKNESS GAGE

- Main body is made of hard plastic



2870-10

Code	Range	Graduation	Accuracy
2870-10	0-10mm	0.1mm	±0.1mm

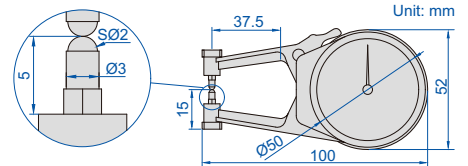

DIGITAL THICKNESS GAGE

- Resolution: 0.01mm, 0.001", 1/64"
- Buttons: on/off, zero, unit (mm/in/fraction), data hold
- Battery CR2032, automatic power off

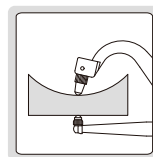

2710-25

Code	Range	Accuracy	Repeatability
2710-25	0-25.4mm/0-1"	0.05mm	0.02mm

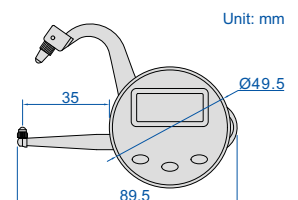

DIGITAL RUBBER THICKNESS GAGES

DATA
OUTPUT

11

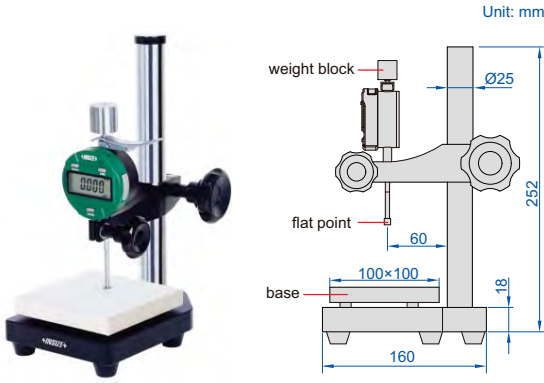

2878-6B

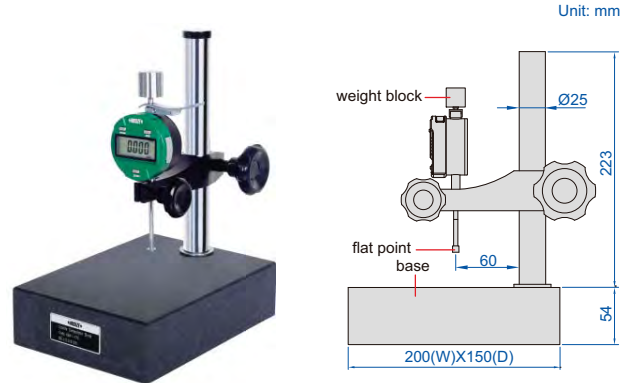

2878-71B

- Measure thickness of vulcanized rubber and plastic products
- Button function: on/off, inch/mm, zero, data preset, change measuring direction, absolute/incremental measurement
- CR2032 battery, automatic power off (time is adjustable)
- Supplied with dust cover
- Optional accessory: data output cable (code **7315-50M** page 5, **7302-50M** page 13), flat points, weight blocks

Code	Range	Resolution	Accuracy	Flat point diameter	Pressure	Base
2878-6A	12.7mm/0.5"	0.01mm/0.0005"	20µm	6mm	22kPa±5kPa	ceramic, plain, flatness 1.5µm
2878-6B	12.7mm/0.5"	0.001mm/0.00005"	5µm	6mm	22kPa±5kPa	ceramic, plain, flatness 1.5µm
2878-71A	12.7mm/0.5"	0.01mm/0.0005"	20µm	6mm	22kPa±5kPa	granite, plain, flatness 2.5µm
2878-71B	12.7mm/0.5"	0.001mm/0.00005"	5µm	6mm	22kPa±5kPa	granite, plain, flatness 2.5µm

Flat points and weight blocks (optional)

Flat point	Flat point code	Pressure				
		10kPa±2kPa weight block code	22kPa±5kPa weight block code	20kPa±3kPa weight block code	70kPa±5kPa weight block code	1.6kPa±0.1kPa weight block code
Ø4mm	2878-P4	—	2878-W4B	—	—	—
Ø5mm	2878-P5	2878-W5A	2878-W5B	2878-W5C	2878-W5D	—
Ø6mm	2878-P6	2878-W6A	2878-W6B	—	—	—
Ø8mm	2878-P8	2878-W8A	2878-W8B	—	—	—
Ø10mm	2878-P10	2878-W10A	2878-W10B	2878-W10C	—	—
Ø25mm	2878-P25	—	—	—	—	2878-W25E
1x4mm (rectangle)	2878-P14	—	—	—	2878-W14D	—

DATA OUTPUT

measure wall thickness of grooves

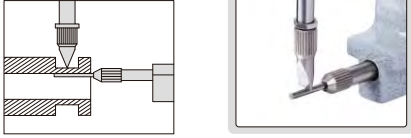

- Buttons: on/off, inch/mm, zero, data preset, change measuring direction, absolute/incremental measurement
- Keep preset data in memory after restart
- Battery CR2032, automatic power off (time is adjustable)
- Data output
- Optional accessory: data output cable (code 7315-50M page 5, 7302-50M page 13)

Code	Range	Resolution	Accuracy
2873-10	0-10mm/0-0.4"	0.01mm/0.0005"	±0.02mm
2873-101	0-10mm/0-0.4"	0.001mm/0.00005"	±0.005mm

DIGITAL TUBE THICKNESS GAGES



2873-10

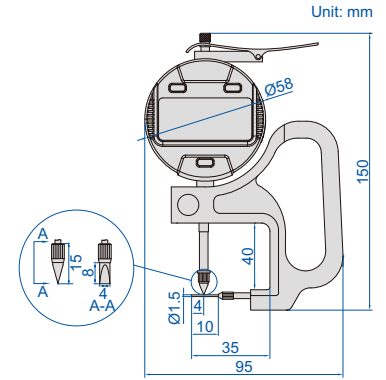

DATA OUTPUT

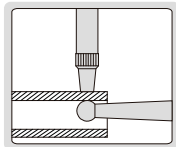

- Buttons: on/off, inch/mm, zero, data preset, change measuring direction, absolute/incremental measurement
- Keep preset data in memory after restart
- Battery CR2032, automatic power off (time is adjustable)
- Data output
- Optional accessory: data output cable (code 7315-50M page 5, 7302-50M page 13)

Code	Range	Resolution	Accuracy
2876-10	0-10mm/0-0.4"	0.01mm/0.0005"	±0.02mm
2876-101	0-10mm/0-0.4"	0.001mm/0.00005"	±0.005mm

DIGITAL TUBE THICKNESS GAGES



2876-10

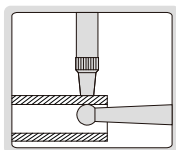
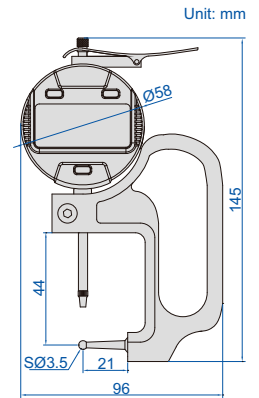

- Measure tube wall thickness

Code	Range	Graduation	Accuracy
2367-10A	0-10mm	0.01mm	±0.02mm

TUBE THICKNESS GAGE



2367-10A

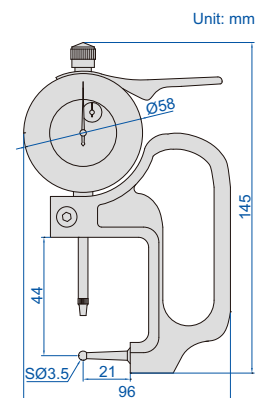

DIGITAL TUBE THICKNESS GAGES

DATA
OUTPUT

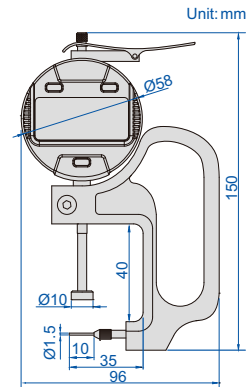
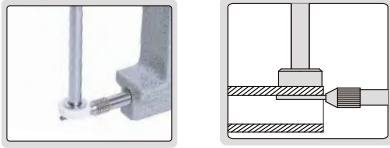

2859-101

- Buttons: on/off, inch/mm, zero, data preset, change measuring direction, absolute/incremental measurement
- Keep preset data in memory after restart
- Battery CR2032, automatic power off (time is adjustable)
- Data output
- Optional accessory: data output cable (code 7315-50M page 5, 7302-50M page 13)

Code	Range	Resolution	Accuracy
2859-10	0-10mm/0-0.4"	0.01mm/0.0005"	±0.02mm
2859-101	0-10mm/0-0.4"	0.001mm/0.00005"	±0.005mm

DIAL SNAP GAGES

INSIZE PLUS
MADE IN EUROPE

IP54
WATERPROOF

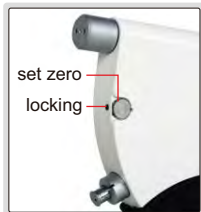

3335-25

- Quick Go/No-Go measurement for mass production
- Anvil retracting stroke: 2.5mm
- Dial indicator: measuring range ± 0.07 mm, graduation $1\mu\text{m}$, accuracy $\pm 1\mu\text{m}$
- Constant measuring force over the whole range: 8.5N
- Carbide measuring faces
- IP54 dust/waterproof
- Zero position of dial indicator is adjustable and can be locked (supplied with locking wrench)
- Adjustable platform height

Code	Range	L	a	b
3335-25	0-25mm	35mm	191mm	<15mm
3335-50	25-50mm	60mm	215mm	<25mm
3335-75	50-75mm	84mm	239mm	<37.5mm
3335-100	75-100mm	110mm	265mm	<50mm

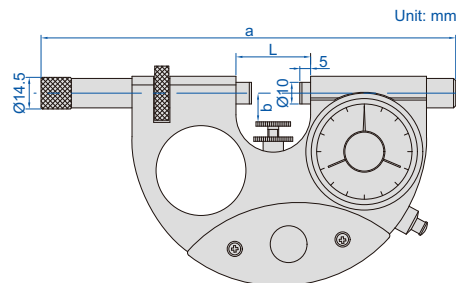

ATTENTION: SETTING
STANDARDS ARE NOT INCLUDED

IP54
WATERPROOF

DIAL SNAP GAGES

- Quick measurement for mass production
- Dial indicator: range $\pm 0.04\text{mm}$, graduation 0.001mm , accuracy 0.001mm
- IP54 dust/waterproof
- Measuring force: 5-10N
- Carbide measuring faces
- Optional accessory: gage blocks grade 0 (4101-A series), for zero setting



3334-25

Code	Range	L	D
3334-25	0-25mm	28.5mm	25mm
3334-50	25-50mm	53.5mm	35mm
3334-75	50-75mm	78.5mm	47.5mm
3334-100	75-100mm	103.5mm	60mm

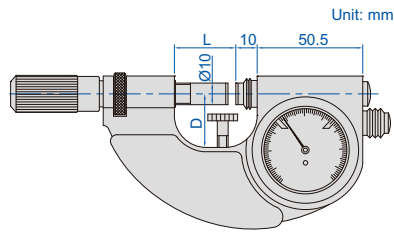

QUICK AND ACCURATE MEASUREMENT
OF CYLINDRICAL WORKPIECES

INSPECTION
CERTIFICATE

DIAL SNAP GAGES



- Left anvil retracting stroke: 2mm
- Measuring force: 6-8N
- Flatness of anvil: $1.5\mu\text{m}$
- Repeatability: $1\mu\text{m}$
- Carbide measuring faces for anvils
- Front edges of anvils are chamfered for easy workpiece insertion
- Optional accessory: dial indicators and digital indicators (reading 0.001mm or 0.01mm)



2186-25

application



Code	Range	Parallelism of measuring faces	A	B	C
2186-25 *	0-25mm	$4\mu\text{m}$	42	11-18	20
2186-50 *	25-50mm	$4\mu\text{m}$	69	11-32	41
2186-75 *	50-75mm	$5\mu\text{m}$	94	17-41	51
2186-100 *	75-100mm	$6\mu\text{m}$	119	31-55	65
2186-125 *	100-125mm	$6\mu\text{m}$	144	42-70	75
2186-150 *	125-150mm	$8\mu\text{m}$	169	55-82	90
2186-175 *	150-175mm	$8\mu\text{m}$	194	68-95	100
2186-200 *	175-200mm	$10\mu\text{m}$	219	85-110	115
2186-225 *	200-225mm	$10\mu\text{m}$	244	95-120	130
2186-250 *	225-250mm	$10\mu\text{m}$	269	110-135	145
2186-275 *	250-275mm	$12\mu\text{m}$	294	120-150	160
2186-300 *	275-300mm	$12\mu\text{m}$	319	128-160	170

(mm)

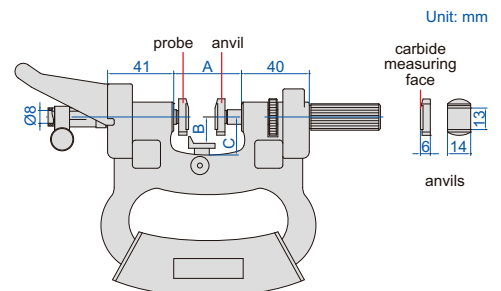

* Supplied with manufacturer inspection certificate

DIAL SNAP GAGES

ATTENTION: NOT SUITABLE FOR 0.001MM DIAL INDICATORS

- Quick measurement for mass production
- Anvil retracting stroke: 3mm
- Measuring force: 6-9N
- Carbide measuring faces
- Optional accessory:
dial indicators (graduation 0.01mm),
digital indicators (resolution 0.01mm/0.0005")



2184-50W

11

Code	Range	A	B
2184-25W	0-25mm	34mm	18mm
2184-50W	0-50mm	62mm	32mm
2184-100W	50-100mm	112mm	62mm
2184-150W	100-150mm	162mm	85mm
2184-200W	150-200mm	212mm	110mm

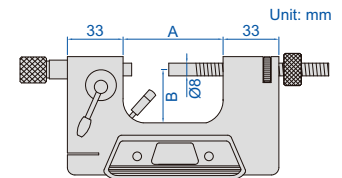

DIGITAL SNAP GAGE

ATTENTION: NO DATA OUTPUT



2166-12

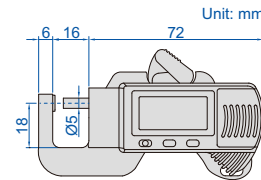

Code	Range	Resolution	Accuracy
2166-12	0-12mm/0-0.5"	0.01mm/0.0005"	±0.03mm

DIGITAL SNAP GAGE

ATTENTION: NO DATA OUTPUT



2167-25

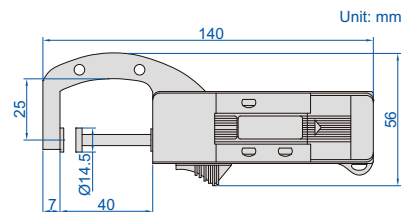

Code	Range	Resolution	Accuracy
2167-25	0-25mm/0-1"	0.01mm/0.0005"	±0.03mm

ATTENTION: NO DATA OUTPUT

DIGITAL SNAP GAGE



2163-25

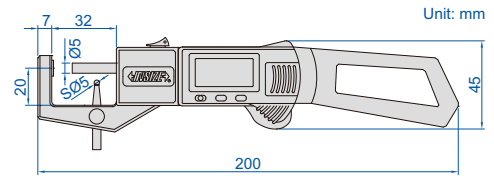

- Resolution: 0.01mm/0.0005"
- Accuracy: ± 0.04 mm
- For thickness and tube wall thickness measurement

Code	Thickness range	Tube wall thickness range
2163-25	0-25mm/0-1"	0-2mm/0.08"

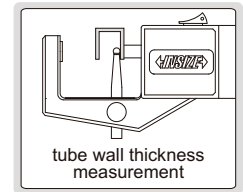
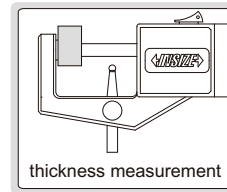

DATA OUTPUT

DIGITAL SNAP GAGES

- Non waterproof
- Buttons: on/off, zero, mm/inch
- Automatic power off, move the digital unit to turn on power
- Battery CR2032
- Made of stainless steel



1163-50A

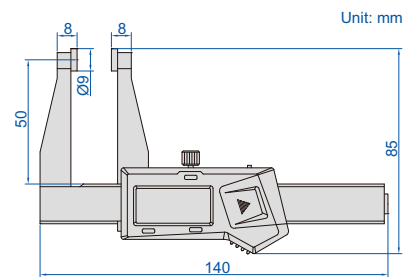

With data interface (data output cable code 7315-21 page 4, 7302-21 page 12, optional)

Code	Range	Resolution	Accuracy
1163-50A	0-50mm/0-2"	0.01mm/0.0005"	± 0.03 mm

Built-in wireless (receiver code 7315-2/3/6/7/8/9 is required)

Code	Range	Resolution	Accuracy
1163-50AWL	0-50mm/0-2"	0.01mm/0.0005"	± 0.03 mm

ATTENTION: NO DATA OUTPUT

SUITABLE FOR JEWELLERY

DIGITAL 3-PURPOSE SNAP GAGE



2164-25A

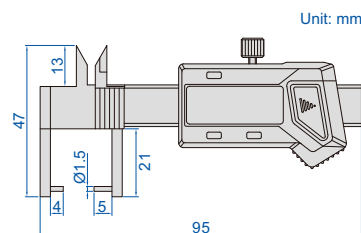

Code	Range	Resolution	Accuracy
2164-25A	0-25mm/0-1"	0.01mm/0.0005"	± 0.03 mm

- Non waterproof
- Buttons: zero, mm/inch, on/off
- Battery LR44
- Made of stainless steel

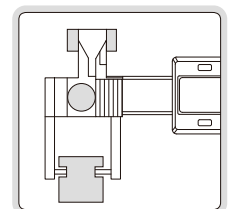

STEP AND GAP GAGES

DATA OUTPUT



zero setting block (included)



- Non waterproof
- Measure step height and gap width
- Resolution: 0.01mm/0.0005"
- Buttons: on/off, set, mm/inch, preset (+, -)
- Automatic power off, move the digital unit to turn on power
- Battery CR2032
- Made of stainless steel
- Supplied with zero setting block

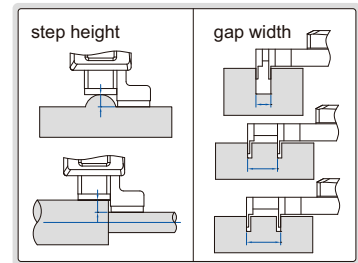
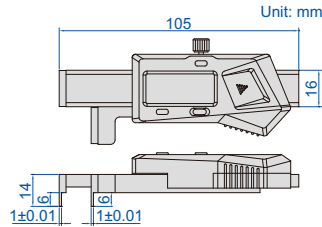

With data interface (data output cable code 7315-21 page 4, 7302-21 page 12, optional)

Code	Range	Accuracy
2168-12	0-12.7mm/0-0.5"	±0.03mm

Built-in wireless (receiver code 7315-2/3/6/7/8/9 is required)

Code	Range	Accuracy
2168-12WL	0-12.7mm/0-0.5"	±0.03mm

11

MINI DIGITAL HEIGHT GAGES

DATA OUTPUT

- Non waterproof
- Measure height difference of two surfaces (1146-20B, 1146-20BWL suitable for surfaces with barrier, such as rivet)
- Resolution: 0.01mm/0.0005"
- Buttons: on/off, zero, mm/inch
- Automatic power off, move the digital unit to turn on power
- Battery CR2032
- Made of stainless steel

With data interface (data output cable code 7315-21 page 4, 7302-21 page 12, optional)

Code	Range	Accuracy
1146-20A	0~±20mm/0~±0.8"	±0.02mm
1146-20B	0~±20mm/0~±0.8"	±0.02mm

Built-in wireless (receiver code 7315-2/3/6/7/8/9 is required)

Code	Range	Accuracy
1146-20AWL	0~±20mm/0~±0.8"	±0.02mm
1146-20BWL	0~±20mm/0~±0.8"	±0.02mm

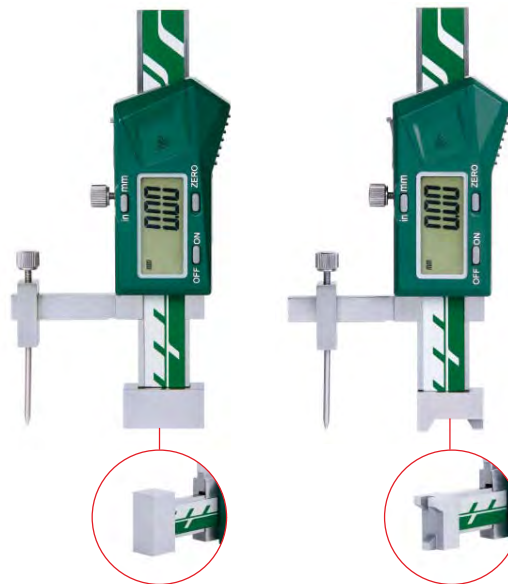

1146-20A

1146-20B

application of 1146-20A/1146-20AWL

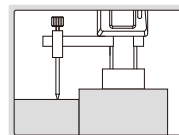

application of 1146-20B/1146-20BWL

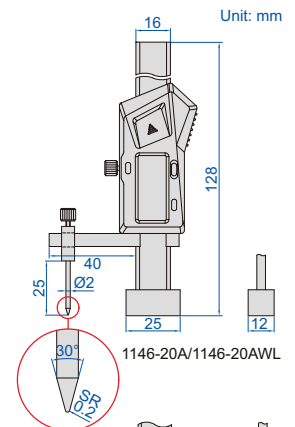
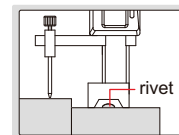

1146-20A/1146-20AWL

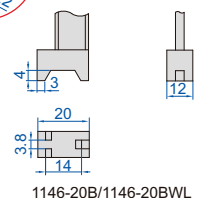

1146-20B/1146-20BWL

DIAL HEIGHT GAGES

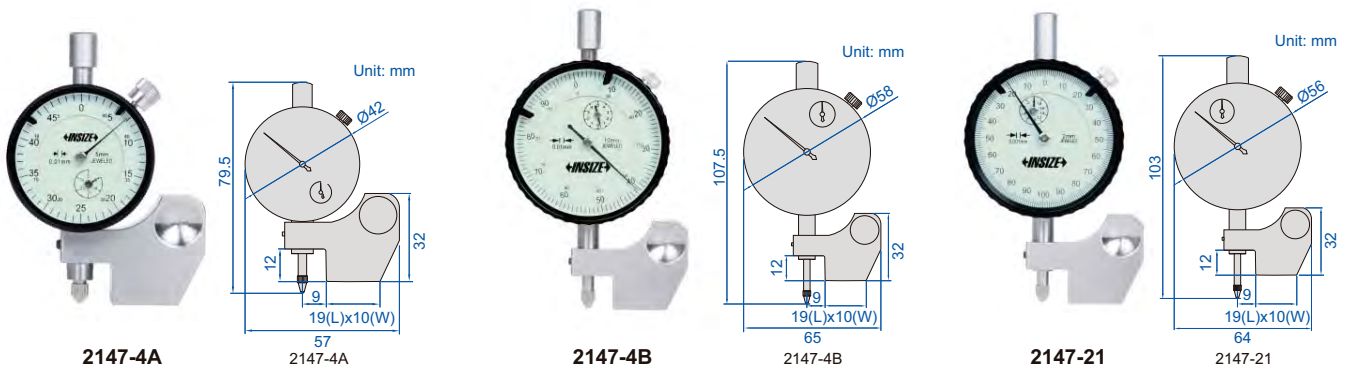

- Measure height difference of two surfaces

Code	Range	Dial indicator stroke	Dial indicator graduation	Accuracy
2147-4A	0~±5mm (adjustable)	5mm	0.01mm	±0.014mm
2147-4B	0~±5mm	10mm	0.01mm	±0.017mm
2147-21	0~±2mm (adjustable)	2mm	0.001mm	±0.006mm

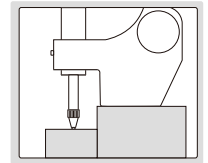

11

DATA
OUTPUT

DIGITAL HEIGHT GAGES

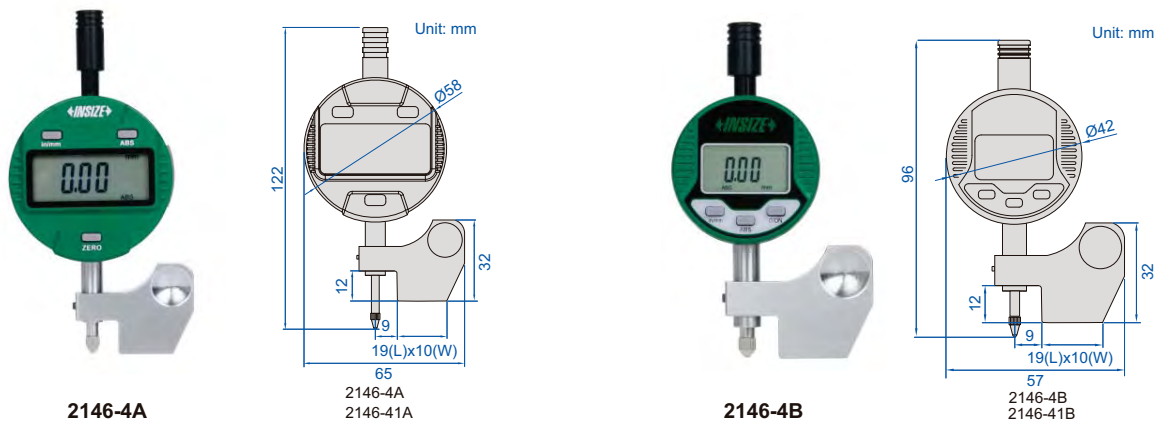

- Measure height difference of two surfaces
- Button function: on/off, inch/mm, zero, data preset, change measuring direction, absolute/incremental measurement
- Keep preset data in memory after restart
- CR2032 battery, automatic power off (time is adjustable)
- Data output
- Optional accessory: data output cable (code 7315-50M page 5, 7302-40M page 13)

measure sunked step

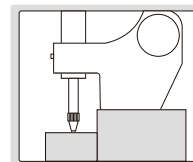

measure raised step

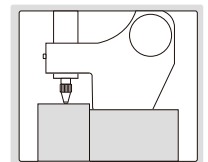

Code	Range (adjustable)	Digital indicator stroke	Digital indicator resolution	Accuracy
2146-4A	0~4mm/0~0.16" (sunked)	12.7mm/0.5"	0.01mm/0.0005"	±0.02mm
2146-41A	0~12.7mm/0~0.5" (raised)	12.7mm/0.5"	0.001mm/0.00005"	±0.005mm
2146-4B	0~4mm/0~0.16" (sunked)	5mm/0.2"	0.01mm/0.0005"	±0.02mm
2146-41B	0~5mm/0~0.2" (raised)	5mm/0.2"	0.001mm/0.00005"	±0.005mm

CRANKSHAFT TESTERS

Unit: mm

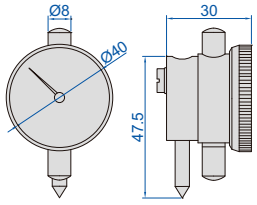

dial indicator

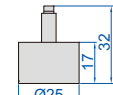

balance block

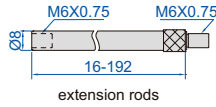

extension rods

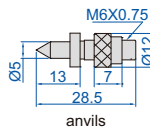
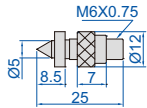

anvils

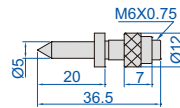

2841-500

11

- To test crankshaft deflection
- The balance block is mounted on the back of dial indicator to keep the dial indicator facing up

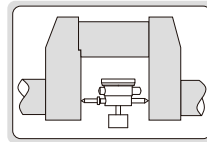

Code	Range	Dial indicator range	Graduation	Extension rods	Accuracy
2841-300	60-300mm	3mm	0.01mm	16mm, 32mm, 64mm, 128mm	±0.016mm
2841-500	60-500mm	3mm	0.01mm	16mm, 32mm, 64mm, 96mm, 128mm, 192mm	±0.016mm

KEYWAY SYMMETRY GAGE



application

step 1: measure

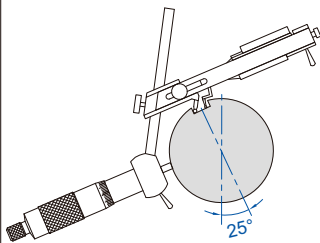

step 2: turn around the workpiece 180° and measure

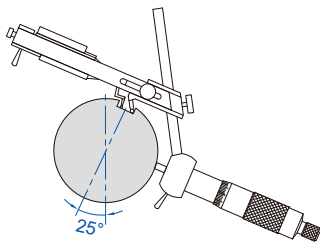

4865-14

- Used to measure the symmetry of shaft keyways

Code	Range		Graduation	Accuracy	L
	diameter of shaft	width of keyway			
4865-14	14-110mm	5-28mm	0.01mm	0.02mm	100mm

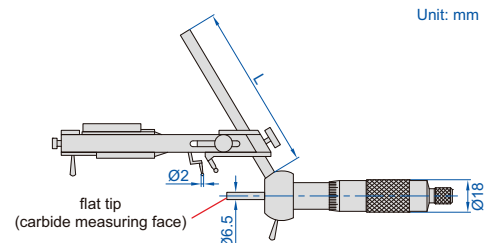

DATA
OUTPUT

DIGITAL KEYWAY DEPTH GAGE

measure depth of keyway

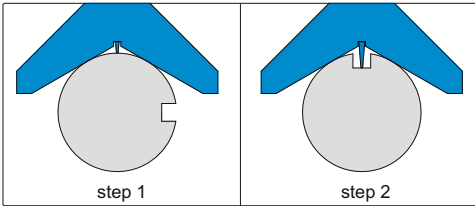
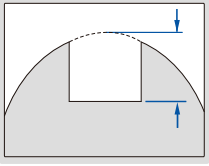

- Measure keyway depth of cylindrical workpieces with diameter $\varnothing 10-100\text{mm}$
- Button function: on/off, zero, inch/metric conversion absolute/incremental measurement, data preset, measuring direction change
- CR2032 battery, automatic power off (time is adjustable)
- Data output
- Stainless steel base
- Pointed tip
- Optional accessory: data output cable (code **7315-50M** page 5, **7302-40M** page 13)



2182-25

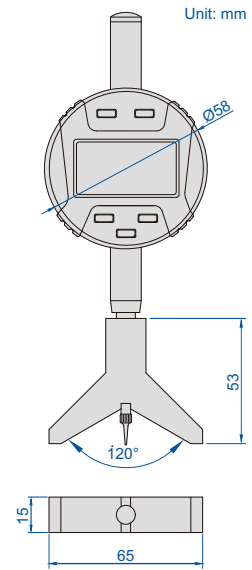

Code	Range	Resolution	Accuracy
2182-25	0-25.4mm/0-1"	0.01mm/0.0005"	$\pm 0.02\text{mm}$

DIAL KEYWAY DEPTH GAGE

measure depth of keyway

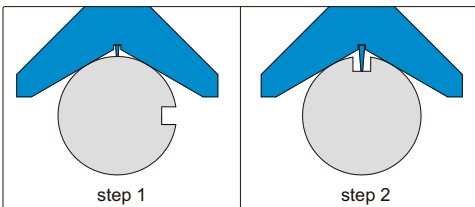
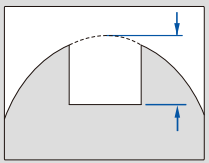

- Measure keyway depth of cylindrical workpieces with diameter $\varnothing 10-100\text{mm}$
- Stainless steel base
- Pointed tip



2189-30

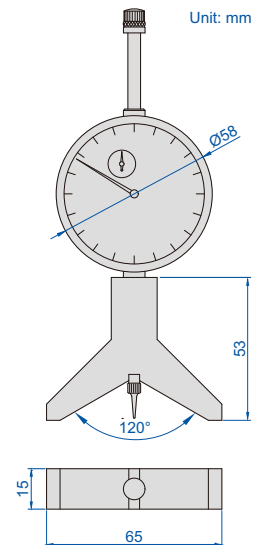

Code	Range	Graduation	Accuracy
2189-30	0-30mm	0.01mm	$\pm 0.03\text{mm}$



Thread Pitch Measuring Instruments
Page 269-270



Thread Taper Measuring Instruments
Page 271-273



Thread Height Measuring Instruments
Page 274-275



Thread Crest Diameter Measuring Instruments
Page 276-279



Groove Diameter Measuring Instruments
Page 280



Groove Width Measuring Instruments
Page 281



Calipers With Interchangeable Ball Tips
Page 282



RTJ Ring Groove Calipers
Page 282



Thread Gages For Petroleum Equipment
Page 282

MEET INTERNATIONAL
STANDARD API5B

DIGITAL THREAD PITCH MEASURING INSTRUMENT

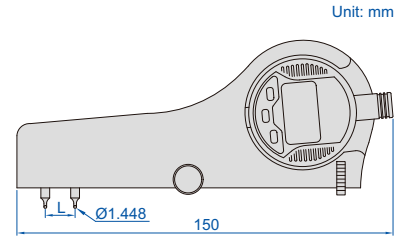
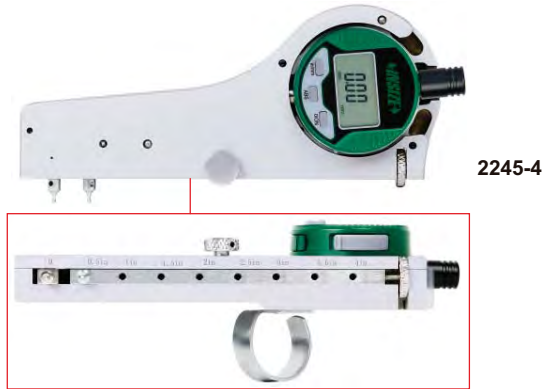

Unit: mm

application

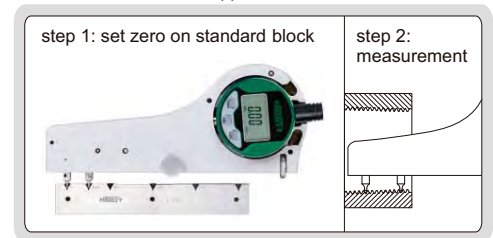

- Measure the pitch of external thread and internal thread with nominal diameter larger than 5 1/2" (139.7mm)
- Optional accessory: data output cable (code 7315-50M page 5, 7302-50M page 13), ball points (code 6252 series), standard pitch blocks (code 6251 series)

12

Code	Range (L)	Digital indicator stroke	Resolution	Accuracy
2245-4	0.5-4"/12.7-101.6mm	0.2"/5mm	0.0005"/0.01mm	0.02mm

MEET INTERNATIONAL
STANDARD API5B

THREAD PITCH MEASURING INSTRUMENTS

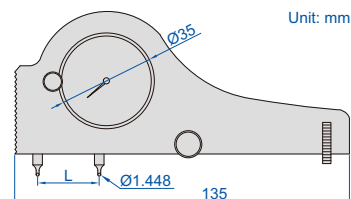

Unit: mm

application

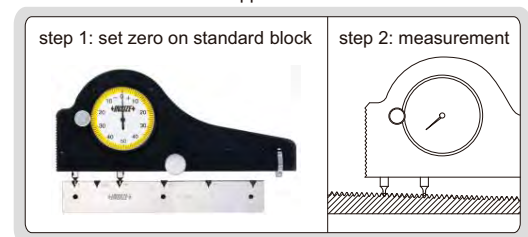

- Measure the pitch of external thread and internal thread with nominal diameter larger than 5 1/2" (139.7mm)
- Optional accessory: ball points (code 6252 series), standard pitch blocks (code 6251 series)

Code	Range (L)	Dial indicator stroke	Dial indicator graduation	Accuracy
2234-4	0.5-4"/12.7-101.6mm	0.5mm	0.01mm	0.02mm
2234-4E	0.5-4"/12.7-101.6mm	0.025"	0.0005"	0.0008"

INTERNAL THREAD PITCH MEASURING INSTRUMENTS

MEET INTERNATIONAL STANDARD API5B



2235-4

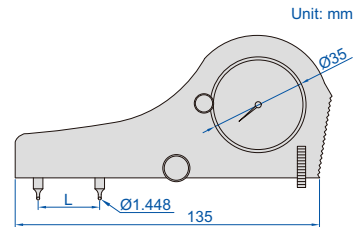

12

- Measure the pitch of internal thread with nominal diameter larger than 1 1/2" (38.1mm) and less than 5 1/2" (139.7mm)
- Optional accessory: ball points (code 6252 series), standard pitch blocks (code 6251 series)

application

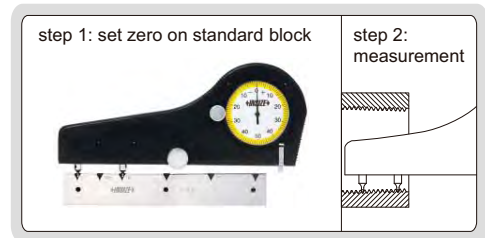

Code	Range (L)	Dial indicator stroke	Dial indicator graduation	Accuracy
2235-4	0.5-4"/12.7-101.6mm	0.5mm	0.01mm	0.02mm
2235-4E	0.5-4"/12.7-101.6mm	0.025"	0.0005"	0.0008"

STANDARD PITCH BLOCKS

CAN BE CUSTOMIZED ACCORDING TO WORKPIECES



6251-S8

- Set zero of internal and external pitch measuring instruments (code 2234, 2235, 2245)

Code	Taper	Threads per inch
6251-S8	1:16	8, 10
6251-S5	1:16	5
6251-S4	1:6	4

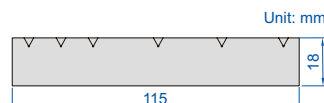

MEET INTERNATIONAL
STANDARD API5B

DIGITAL EXTERNAL THREAD TAPER MEASURING INSTRUMENT

- Measure the taper of external thread
- Digital indicator stroke: 10mm/0.4"
- Optional accessory: data output cable (code 7315-50M page 5, 7302-40M page 13), ball points (code 6252 series)

principle of measurement

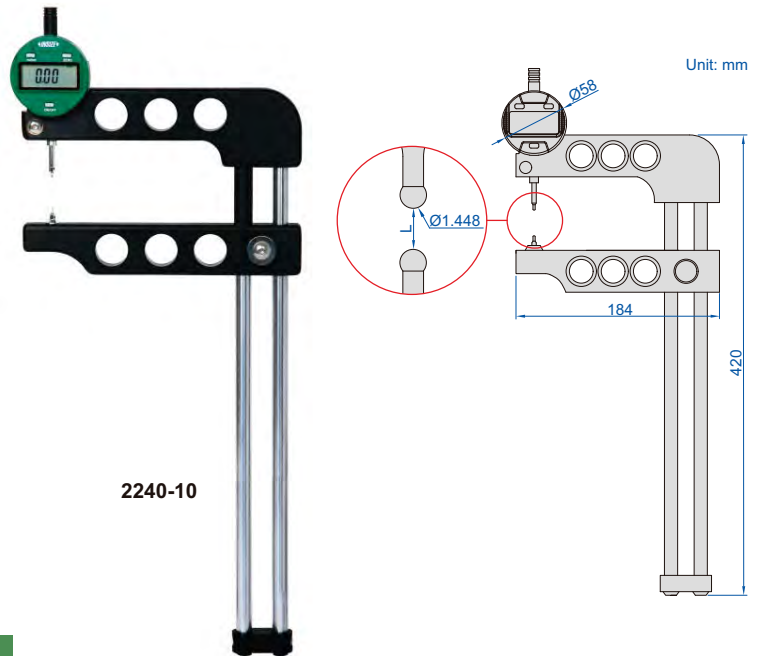
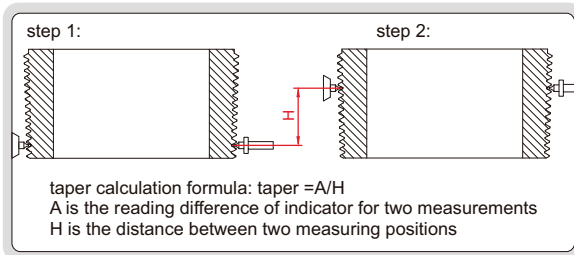

2240-10

Code	Range (L)	Resolution	Accuracy
2240-10	0-10"/0-254mm	0.0005"/0.01mm	0.03mm

MEET INTERNATIONAL
STANDARD API5B

EXTERNAL THREAD TAPER MEASURING INSTRUMENTS

- Measure the taper of external thread
- Dial indicator stroke: 0.5"
- Dial indicator graduation: 0.001"
- Optional accessory: ball points (code 6252 series)

principle of measurement

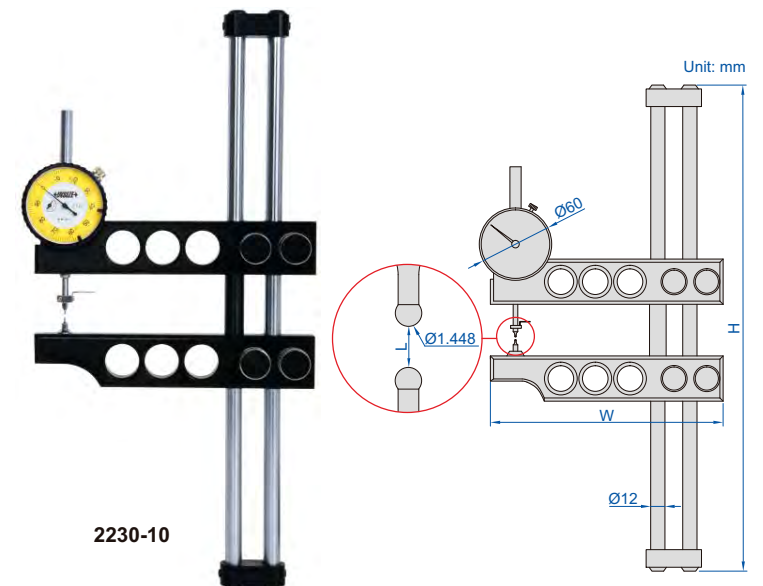
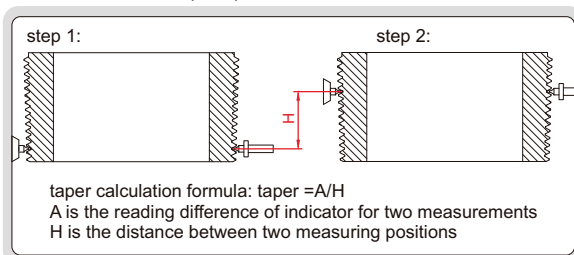

2230-10

Code	Range (L)	Accuracy	H	W
2230-10	0-10"/0-254mm	0.0015"	400mm	200mm
2230-45	1-4 1/2"/25.4-114.3mm	0.0015"	278mm	178mm
2230-16	8-16"/203.2-406.4mm	0.0015"	600mm	260mm
2230-20	8-20"/203.2-508mm	0.0015"	680mm	260mm

INTERNAL THREAD TAPER MEASURING INSTRUMENTS

MEET INTERNATIONAL STANDARD API5B



2231-6



2231-16

12

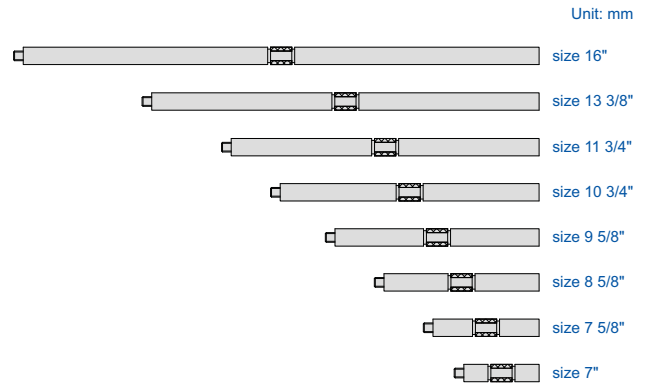
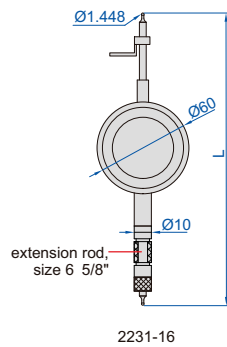
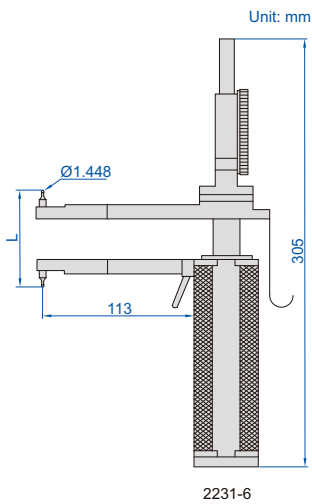

- Measure the taper of internal thread
- Optional accessory: ball points (code 6252 series)

principle of measurement

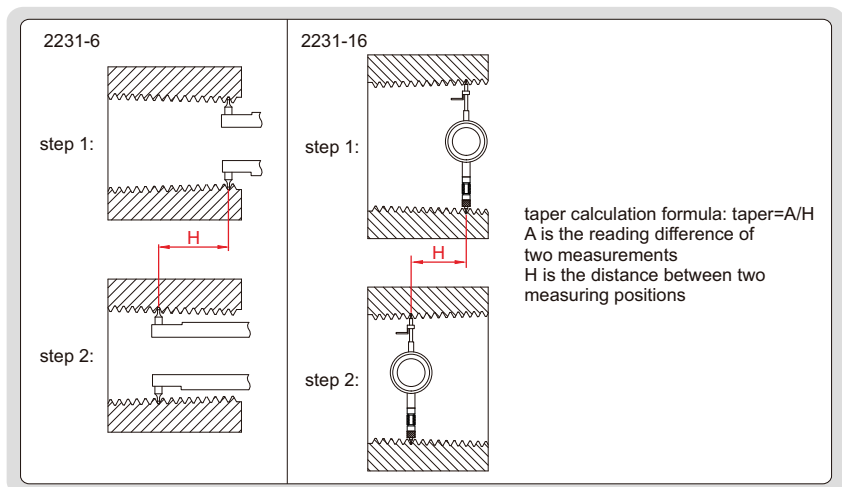

Code	Range (L)	Dial indicator stroke	Dial indicator graduation	Accuracy	Remark
2231-6	1.5-6"/38.1-152.4mm	1"	0.001"	0.0015"	—
2231-16	5 1/2-16"/139.7-406.4mm	0.5"	0.001"	0.0015"	with 9 extension rods

MEET INTERNATIONAL
STANDARD API5B

DIGITAL INTERNAL THREAD TAPER MEASURING INSTRUMENT

principle of measurement

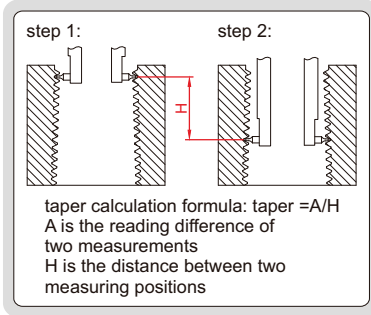

2241-6

- Measure the taper of internal thread
- Digital indicator stroke: 25.4mm/1"
- Optional accessory: data output cable (code **7315-50M** page 5, **7302-40M** page 13), ball points (code **6252** series)

Code	Range (L)	Resolution	Accuracy
2241-6	1.5-6"/38.1-152.4mm	0.0005"/0.01mm	0.04mm

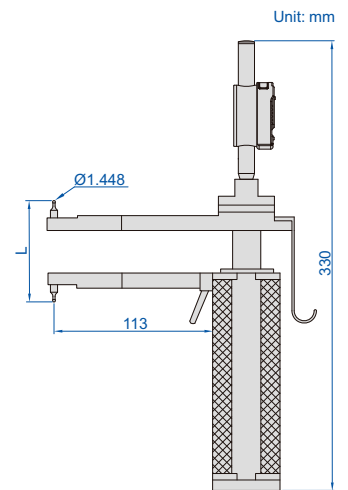

12

BALL POINTS

- Supplied in pair
- For taper measuring instruments (code **2230, 2231, 2240, 2241**) and pitch measuring instruments (code **2234, 2235, 2245**)



6252-B10

Code	Thread type	Threads per inch	Ball dia. (Ød)	
			taper	pitch
6252-B8	round thread, line pipe	8	1.829mm	1.829mm
6252-B10	round thread, line pipe	10	1.448mm	1.448mm
6252-B115	line pipe	11.5	1.27mm	1.27mm
6252-B14	line pipe	14	1.041mm	1.041mm
6252-B18	line pipe	18	0.813mm	0.813mm
6252-B27	line pipe	27	0.533mm	0.533mm
6252-B5	buttress thread	5	2.286mm	—
6252-B51	buttress thread	5	—	1.575mm
6252-B52	extreme line thread	5,6	1.524mm	—
6252-B53	extreme line thread	5	—	2.667mm*
6252-B6	extreme line thread	6	—	2.210mm*

* 0.58mm off the top of ball

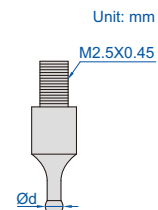

DIGITAL INTERNAL THREAD HEIGHT MEASURING INSTRUMENT

MEET INTERNATIONAL STANDARD API5B

application

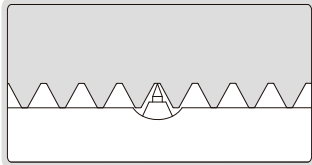

2243-35

- Measure the height of internal thread with nominal diameter less than 5 1/2" (139.7mm)
- Optional accessory: data output cable (code 7315-50M page 5, 7302-50M page 13), thread height standard blocks (code 6250)

Unit: mm

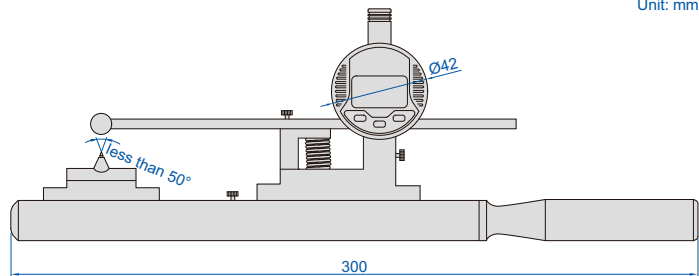

Code	Range	Resolution	Accuracy
2243-35	0-0.135"/0-3.5mm	0.005"/0.01mm	0.02mm

INTERNAL THREAD HEIGHT MEASURING INSTRUMENTS

MEET INTERNATIONAL STANDARD API5B

application

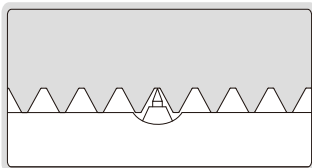

2233-35

- Measure the height of internal thread with nominal diameter less than 5 1/2" (139.7mm)
- Optional accessory: thread height standard blocks (code 6250)

Unit: mm

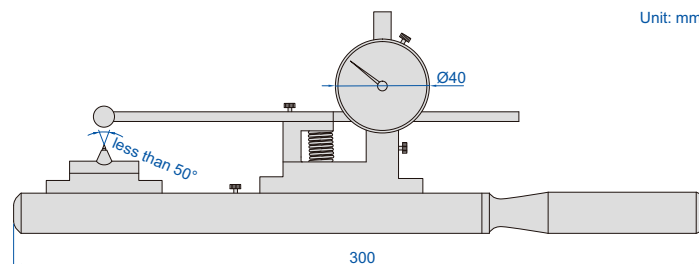

Code	Range	Dial indicator graduation	Accuracy
2233-35	0-3.5mm	0.01mm	0.02mm
2233-35E	0-1/4"	0.0005"	0.0008"

MEET INTERNATIONAL
STANDARD API5B

DIGITAL THREAD HEIGHT MEASURING INSTRUMENT

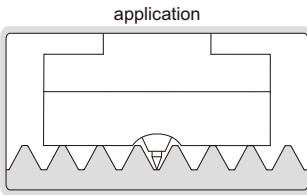

- Measure the height of external thread and internal thread with nominal diameter larger than 5 1/2" (139.7mm)
- Optional accessory: data output cable (code **7315-50M** page 5, **7302-40M** page 13), thread height standard blocks (code **6250**)



2242-35

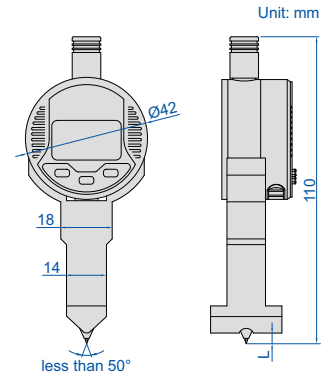

Code	Range (L)	Resolution	Accuracy
2242-35	0-0.135"/0-3.5mm	0.0005"/0.01mm	0.02mm

12

MEET INTERNATIONAL
STANDARD API5B

THREAD HEIGHT MEASURING INSTRUMENTS

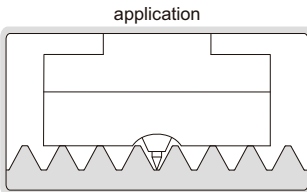

- Measure the height of external thread and internal thread with nominal diameter larger than 5 1/2" (139.7mm)
- Optional accessory: thread height standard blocks (code **6250**)



2232-35

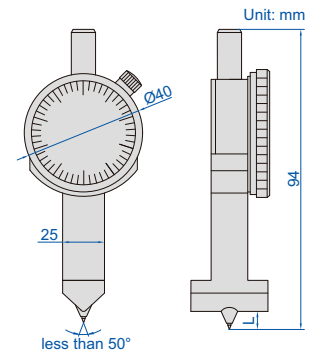

Code	Range (L)	Dial indicator graduation	Accuracy
2232-35	0-3.5mm	0.01mm	0.02mm
2232-35E	0-1/4"	0.0005"	0.0008"

CAN BE CUSTOMIZED
ACCORDING TO WORKPIECES

THREAD HEIGHT STANDARD BLOCKS

- Set zero of internal and external thread height measuring instruments (code **2232**, **2233**, **2242**, **2243**)

Code	Taper	Number of thread per inch
6250-4	1:4	4
6250-5	1:4	5
6250-8	1:16	8, 10
6250-51	1:16	5



6250-8

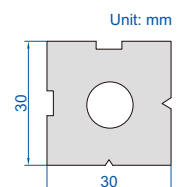

DIGITAL DEPTH GAGE (60° KNIFE EDGE BASE)

REFER TO PAGE 77 FOR DETAILS



2143-101

DIGITAL INTERNAL THREAD CREST DIAMETER MEASURING INSTRUMENT

12

MEET INTERNATIONAL STANDARD API5B

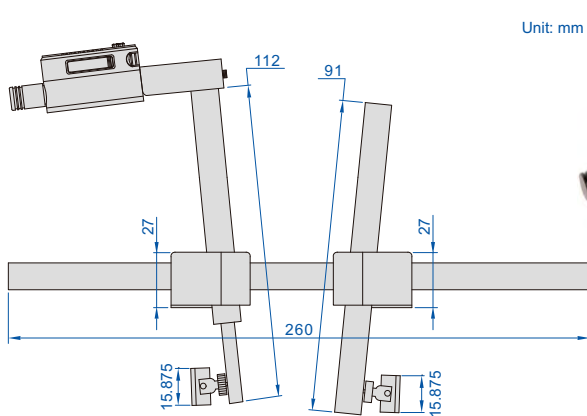

Unit: mm



2247-5

application

- Measure the crest diameter of internal thread with nominal diameter larger than 2 3/8" (60.325mm) and less than 5 1/2" (139.7mm)
- Optional accessory: data output cable (code 7315-50M page 5, 7302-40M page 13), height standard and zero standard block (code 2237-G□□□, 2237-K□□□)

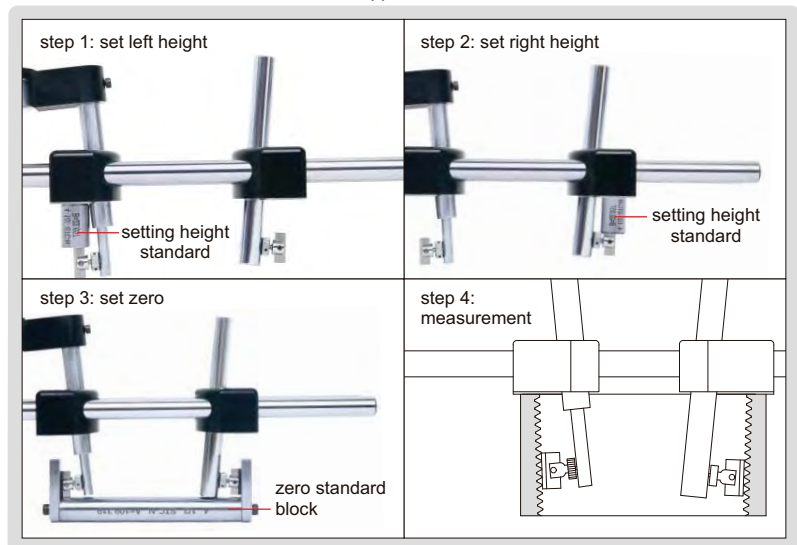

Code	Range	Digital indicator stroke	Resolution	Accuracy
2247-5	2 3/8-5 1/2"/60.325-139.7mm	0.2"/5mm	0.0005"/0.01mm	0.02mm

MEET INTERNATIONAL
STANDARD API5B

INTERNAL THREAD CREST DIAMETER MEASURING INSTRUMENTS



2237-5

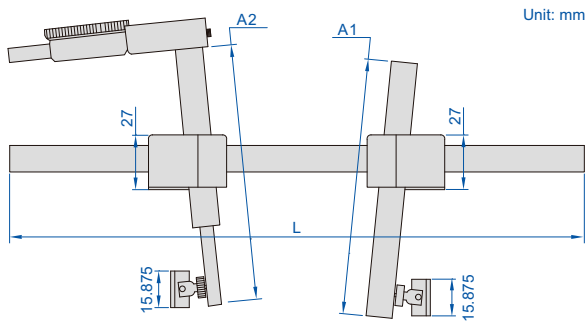

- Measure the crest diameter of internal thread with nominal diameter larger than 2 3/8" (60.325mm) and less than 20" (508mm)
- Optional accessory: height standard and zero standard block

application

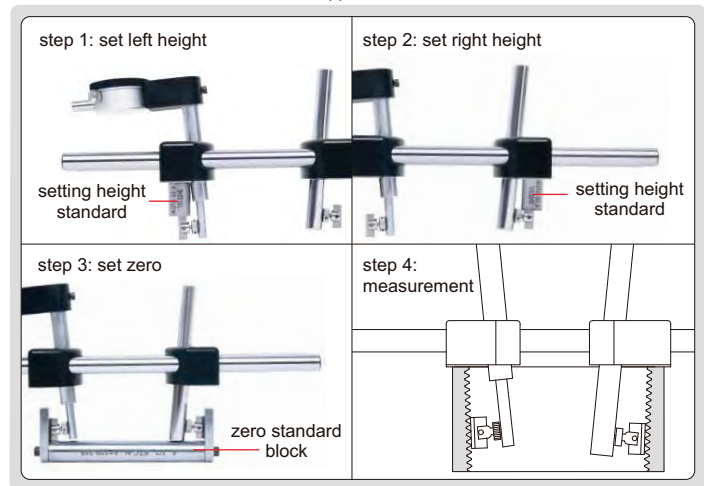

12

Code	Range	Dial indicator stroke	Dial indicator graduation	Accuracy	L	A1	A2
2237-5	2 3/8-5 1/2"/60.325-139.7mm	5mm	0.01mm	0.02mm	260mm	112mm	91mm
2237-5E	2 3/8-5 1/2"/60.325-139.7mm	0.25"	0.0005"	0.0008"	260mm	112mm	91mm
2237-20	4 1/2-20"/114.3-508mm	0.50"	0.0005"	0.002"	12", 18" or 24" *	177mm	182mm

* Select suitable length of arm according to workpieces

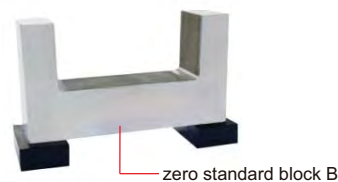

HEIGHT STANDARD AND ZERO STANDARD BLOCK (optional)

Code	Remark
2237-G□□□ *	including height standard and zero standard block A (without taper)
2237-K□□□ *	including height standard and zero standard block B (with taper)

* Can be customized according to workpieces

DIGITAL EXTERNAL THREAD CREST DIAMETER MEASURING INSTRUMENT

MEET INTERNATIONAL
STANDARD API5B



2246-5

12

- Measure the crest diameter of external thread with nominal diameter larger than 2 3/8" (60.325mm) and less than 5 1/2" (139.7mm)
- Optional accessory: data output cable (code **7315-50M** page 5, **7302-40M** page 13), height standard and zero standard block (code **2236-G000**, **2236-K000**)

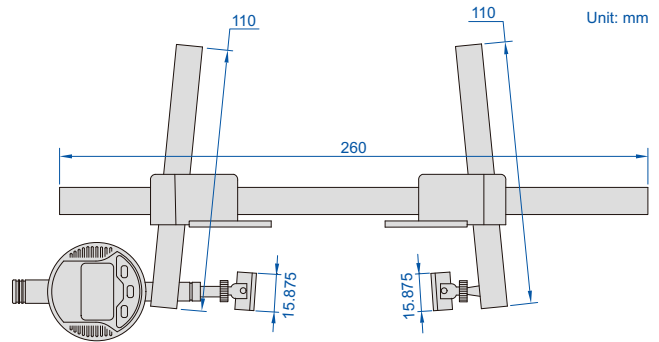

application

<p>step 1: set left height</p> <p>setting height standard</p>	<p>step 2: set right height</p> <p>setting height standard</p>
<p>step 3: set zero</p> <p>zero standard block</p>	<p>step 4: measurement</p>

Code	Range	Digital indicator stroke	Resolution	Accuracy
2246-5	2 3/8-5 1/2"/60.325-139.7mm	0.2"/5mm	0.0005"/0.01mm	0.02mm

MEET INTERNATIONAL
STANDARD API5B

EXTERNAL THREAD CREST DIAMETER MEASURING INSTRUMENTS



2236-5

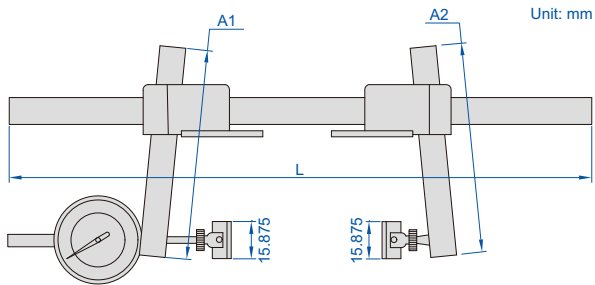

- Measure the crest diameter of external thread with nominal diameter larger than 2 3/8" (60.325mm) and less than 20" (508mm)
- Optional accessory: height standard and zero standard block

application

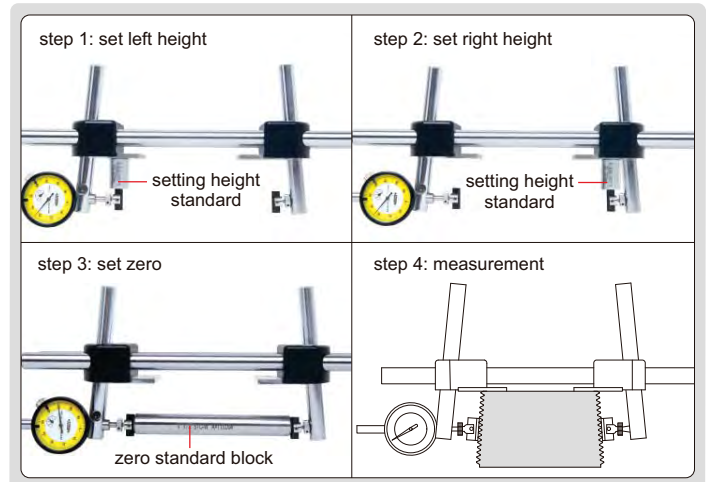

Code	Range	Dial indicator stroke	Dial indicator graduation	Accuracy	L	A1	A2
2236-5	2 3/8-5 1/2"/60.325-139.7mm	5mm	0.01mm	0.02mm	260mm	110mm	110mm
2236-5E	2 3/8-5 1/2"/60.325-139.7mm	0.25"	0.0005"	0.0008"	260mm	110mm	110mm
2236-20	2 3/8-20"/60.325-508mm	0.50"	0.0005"	0.002"	12", 18" or 24" *	177mm	160mm

* Select suitable length of arm according to workpieces

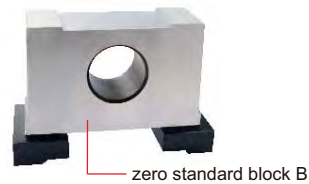

HEIGHT STANDARD AND ZERO STANDARD BLOCK (optional)

Code	Remark
2236-G□□□ *	including height standard and zero standard block A (without taper)
2236-K□□□ *	including height standard and zero standard block B (with taper)

* Can be customized according to workpieces

DIGITAL GROOVE DIAMETER MEASURING INSTRUMENT

POINT DIAMETER CAN BE CUSTOM-MADE



2261-5

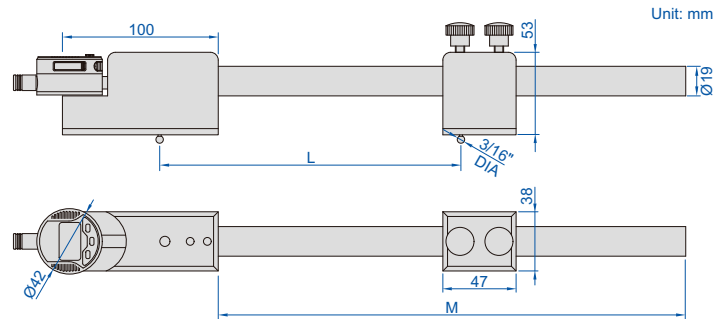
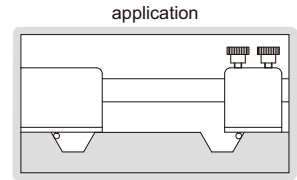

Unit: mm

- Measure the groove diameter of flange ring groove
- Point height is adjustable
- Optional: data output cable (code 7315-50M page 5, 7302-40M page 13), groove standard block (code 6254)

Stem (optional)

Code	M
2261-M24	24"/600mm
2261-M30	30"/750mm
2261-M36	36"/900mm

Code	Range (L)	Movable point stroke	Resolution	Repeatability	M
2261-5	2.6-13"/66-330mm	0.2"/5mm	0.00005"/0.001mm	0.002mm	12"/300mm

12

GROOVE DIAMETER MEASURING INSTRUMENTS

POINT DIAMETER CAN BE CUSTOM-MADE



2251-5

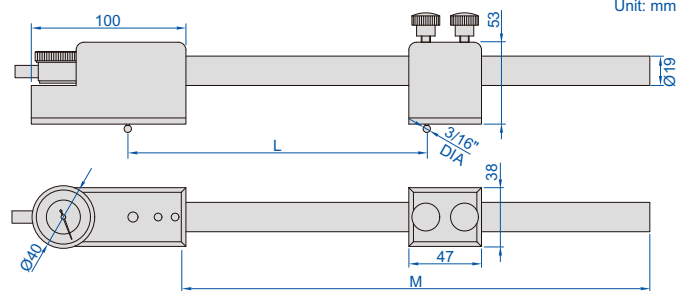
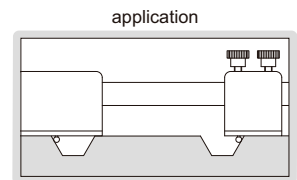

Unit: mm

- Measure the groove diameter of flange ring groove
- Point height is adjustable
- Optional: groove standard block (code 6254)

Stem (optional)

Code	M
2261-M24	24"/600mm
2261-M30	30"/750mm
2261-M36	36"/900mm

Code	Range (L)	Movable point stroke	Graduation	Repeatability	M
2251-5	2.6-13"/66-330mm	0.2"/5mm	0.01mm	0.005mm	12"/300mm
2251-5E	2.6-13"/66-330mm	0.2"/5mm	0.0005"	0.0002"	12"/300mm

POINT DIAMETER CAN BE CUSTOM-MADE

DIGITAL GROOVE WIDTH MEASURING INSTRUMENT

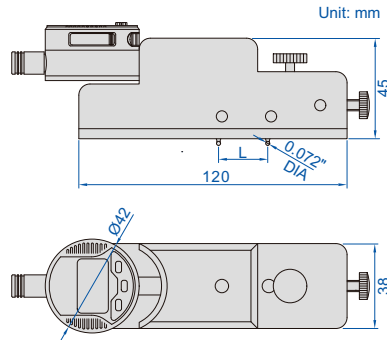
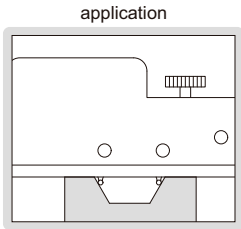

2260-4

- Measure the groove width of flange ring groove
- Point height is adjustable
- Optional: data output cable (code 7315-50M page 5, 7302-40M page 13), groove standard block (code 6254)

Code	Range (L)	Movable point stroke	Resolution	Repeatability
2260-4	0.55-1.4"/14-35.5mm	0.16"/4mm	0.00005"/0.001mm	0.002mm

12

POINT DIAMETER CAN BE CUSTOM-MADE

GROOVE WIDTH MEASURING INSTRUMENTS

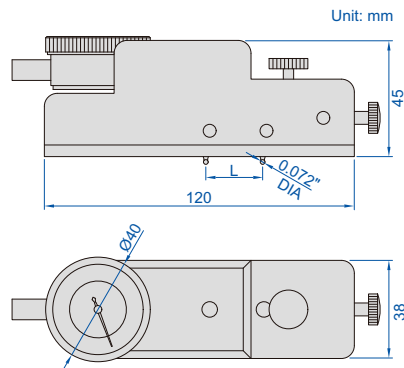
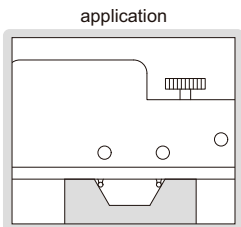

2250-4

- Measure the groove width of flange ring groove
- Point height is adjustable
- Optional: groove standard block (code 6254)

Code	Range (L)	Movable point stroke	Graduation	Repeatability
2250-4	0.55-1.4"/14-35.5mm	0.16"/4mm	0.01mm	0.005mm
2250-4E	0.55-1.4"/14-35.5mm	0.16"/4mm	0.0005"	0.0002"

CUSTOM-MADE

STANDARD GROOVE BLOCK CODE 6254



- Set zero of groove width and groove diameter measuring instruments (code 2250, 2251, 2260, 2261)

DIGITAL CALIPERS WITH INTERCHANGEABLE BALL TIPS

REFER TO PAGE 59 FOR DETAILS



1527-3001



1528-3001

DIGITAL RTJ RING GROOVE CALIPERS

REFER TO PAGE 58 FOR DETAILS



1179-300



1179-600

THREAD GAGES FOR ROTARY SHOULDERED CONNECTIONS OF PETROLEUM EQUIPMENT

REFER TO PAGE 331 FOR DETAILS



4177-23

CASING, TUBING AND LINE PIPE THREAD GAGES OF PETROLEUM AND GAS EQUIPMENT

REFER TO PAGE 332-333 FOR DETAILS



4178-21T



Gage Blocks
Page 284-289



Caliper Inspection Gage Block Sets
Page 289-290



Micrometer Inspection Gage Block Sets
Page 290-291



Gage Block Holders
Page 291



Gage Block Accessories
Page 292



Cylinder Gage Blocks
Page 293



CMM Check Masters
Page 294-295



Caliper/Height Gage Checkers
Page 296



Angle Gage Blocks
Page 297



Taper Gages
Page 297



Pin Gages
Page 298-301



Pin Gage Handles
Page 301-303



Cylinder Gages
Page 304



Adjustable Snap Gages
Page 305



Setting Rings
Page 306

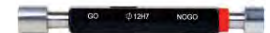

Plain Plug Gages
Page 307



Measuring Balls
Page 308-309



Threaded Hole Location Gages
Page 309-310



Thread Depth Gages
Page 311-312



Thread Ring/Plug Gages
Page 313-333

GAGE BLOCKS

Accuracy according to ISO3650

Nominal length (mm)	Grade 0		Grade 1		Grade 2	
	Limit deviation of length	Tolerance for the variation in length	Limit deviation of length	Tolerance for the variation in length	Limit deviation of length	Tolerance for the variation in length
over 0.5 to 10	±0.12µm	0.10µm	±0.20µm	0.16µm	±0.45µm	0.30µm
over 10 to 25	±0.14µm	0.10µm	±0.30µm	0.16µm	±0.60µm	0.30µm
over 25 to 50	±0.20µm	0.10µm	±0.40µm	0.18µm	±0.80µm	0.30µm
over 50 to 75	±0.25µm	0.12µm	±0.50µm	0.18µm	±1.00µm	0.35µm
over 75 to 100	±0.30µm	0.12µm	±0.60µm	0.20µm	±1.20µm	0.35µm
over 100 to 150	±0.40µm	0.14µm	±0.80µm	0.20µm	±1.60µm	0.40µm
over 150 to 200	±0.50µm	0.16µm	±1.00µm	0.25µm	±2.00µm	0.40µm
over 200 to 250	±0.60µm	0.16µm	±1.20µm	0.25µm	±2.40µm	0.45µm
over 250 to 300	±0.70µm	0.18µm	±1.40µm	0.25µm	±2.80µm	0.50µm
over 300 to 400	±0.90µm	0.20µm	±1.80µm	0.30µm	±3.60µm	0.50µm
over 400 to 500	±1.10µm	0.25µm	±2.20µm	0.35µm	±4.40µm	0.60µm
over 500 to 600	±1.30µm	0.25µm	±2.60µm	0.40µm	±5.00µm	0.70µm
over 600 to 700	±1.50µm	0.30µm	±3.00µm	0.45µm	±6.00µm	0.70µm
over 700 to 800	±1.70µm	0.30µm	±3.40µm	0.50µm	±6.50µm	0.80µm
over 800 to 900	±1.90µm	0.35µm	±3.80µm	0.50µm	±7.50µm	0.90µm
over 900 to 1000	±2.00µm	0.40µm	±4.20µm	0.60µm	±8.00µm	1.00µm

Grade and application

Grade	Application
0	To be used as basic standards in calibration laboratories by skilled inspection staff, to calibrate or set high accuracy measuring instruments, to calibrate gage blocks of grade 1 and 2.
1	To be used in inspection rooms, to check gages, inspect high accuracy parts and set measuring instruments.
2	To be used in workshops, to check production gages, set measuring instruments and mount tools.

WEAR BLOCK SETS



- Protect the measuring surfaces of gage blocks from excessive wear
- Meet ISO3650
- Supplied with manufacturer inspection certificate



4111-2

Blocks per set	Size	Material	Code	
			Grade 0	Grade 1
2	1.0mm	ceramic	4111-1	4111-11
2	1.0mm	alloy steel	4111-1A	4111-11A
2	2.0mm	ceramic	4111-2	4111-12
2	2.0mm	alloy steel	4111-2A	4111-12A

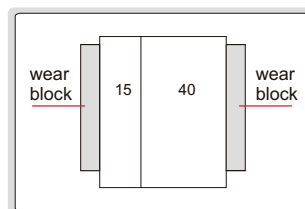

CERAMIC GAGE BLOCK SETS

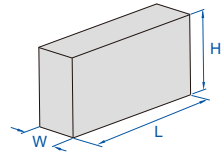

Dimension:

Size(L)	W	H
0.5 ≤ L ≤ 10mm	9mm	30mm
L > 10mm	9mm	35mm



4105-87

- Made of ceramic, extremely wear resistance and corrosion resistance, excellent dimension stability
- Meet ISO3650
- Supplied with manufacturer inspection certificate

Blocks per set	Gage blocks included in set			Code	
	Size (mm)	Step (mm)	Quantity	Grade 0	Grade 1
112	1.0005		1	4105-112	4105-1112
	1.001-1.009	0.001	9		
	1.01-1.49	0.01	49		
	0.5-24.5	0.5	49		
	25-100	25	4		
103	1.005		1	4105-103	4105-1103
	1.01-1.49	0.01	49		
	0.5-24.5	0.5	49		
	25-100	25	4		
88	1.0005		1	4105-88	4105-188
	1.001-1.009	0.001	9		
	1.01-1.49	0.01	49		
	0.5-9.5	0.5	19		
	10-100	10	10		
87	1.001-1.009	0.001	9	4105-87	4105-187
	1.01-1.49	0.01	49		
	0.5-9.5	0.5	19		
	10-100	10	10		
76	1.005		1	4105-76	4105-176
	1.01-1.49	0.01	49		
	0.5-9.5	0.5	19		
	10-40	10	4		
	50-100	25	3		
56	0.5		1	4105-56	4105-156
	1.001-1.009	0.001	9		
	1.01-1.09	0.01	9		
	1.1-1.9	0.1	9		
	1-24	1	24		
	25-100	25	4		

Blocks per set	Gage blocks included in set			Code	
	Size (mm)	Step (mm)	Quantity	Grade 0	Grade 1
47	1.005		1	4105-47A	4105-147A
	1.01-1.09	0.01	9		
	1.1-1.9	0.1	9		
	1-24	1	24		
	25-100	25	4		
47	1.005		1	4105-47	4105-147
	1.01-1.19	0.01	19		
	1.2-1.9	0.1	8		
	1-9	1	9		
	10-100	10	10		
46	1.001-1.009	0.001	9	4105-46	4105-146
	1.01-1.09	0.01	9		
	1.1-1.9	0.1	9		
	1-9	1	9		
	10-100	10	10		
34	1.0005		1	4105-34	4105-134
	1.001-1.009	0.001	9		
	1.01-1.09	0.01	9		
	1.1-1.9	0.1	9		
	1-5	1	5		
32	1.005		1	4105-32	4105-132
	1.01-1.09	0.01	9		
	1.1-1.9	0.1	9		
	1-9	1	9		
	10-30	10	3		
	50		1		

CERAMIC INDIVIDUAL GAGE BLOCKS



4106-A80

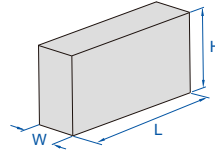

Dimension:

Size(L)	W	H
0.5 ≤ L ≤ 10mm	9mm	30mm
L > 10mm	9mm	35mm

- Grade 0 and 1 gage blocks are available
- Made of ceramic, extremely wear resistance and corrosion resistance
- Meet ISO3650
- Supplied with manufacturer inspection certificate

Code explanation:

4106-X□□□□□

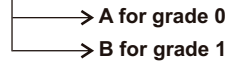

Code examples:

Size (L)	Grade	Code
0.5mm	0	4106-AD5
10mm	1	4106-B10

13

Size	Code	Size	Code	Size	Code	Size	Code
0.5mm	4106- <u>X</u> D5	1.23mm	4106- <u>X</u> 1D23	3mm	4106- <u>X</u> 3	17.6mm	4106- <u>X</u> 17D6
1mm	4106- <u>X</u> 1	1.24mm	4106- <u>X</u> 1D24	3.5mm	4106- <u>X</u> 3D5	18mm	4106- <u>X</u> 18
1.0005mm	4106- <u>X</u> 1D0005	1.25mm	4106- <u>X</u> 1D25	4mm	4106- <u>X</u> 4	18.5mm	4106- <u>X</u> 18D5
1.001mm	4106- <u>X</u> 1D001	1.26mm	4106- <u>X</u> 1D26	4.5mm	4106- <u>X</u> 4D5	19mm	4106- <u>X</u> 19
1.002mm	4106- <u>X</u> 1D002	1.27mm	4106- <u>X</u> 1D27	5mm	4106- <u>X</u> 5	19.5mm	4106- <u>X</u> 19D5
1.003mm	4106- <u>X</u> 1D003	1.28mm	4106- <u>X</u> 1D28	5.1mm	4106- <u>X</u> 5D1	20mm	4106- <u>X</u> 20
1.004mm	4106- <u>X</u> 1D004	1.29mm	4106- <u>X</u> 1D29	5.5mm	4106- <u>X</u> 5D5	20.2mm	4106- <u>X</u> 20D2
1.005mm	4106- <u>X</u> 1D005	1.3mm	4106- <u>X</u> 1D3	6mm	4106- <u>X</u> 6	20.5mm	4106- <u>X</u> 20D5
1.006mm	4106- <u>X</u> 1D006	1.31mm	4106- <u>X</u> 1D31	6.5mm	4106- <u>X</u> 6D5	21mm	4106- <u>X</u> 21
1.007mm	4106- <u>X</u> 1D007	1.32mm	4106- <u>X</u> 1D32	7mm	4106- <u>X</u> 7	21.5mm	4106- <u>X</u> 21D5
1.008mm	4106- <u>X</u> 1D008	1.33mm	4106- <u>X</u> 1D33	7.5mm	4106- <u>X</u> 7D5	22mm	4106- <u>X</u> 22
1.009mm	4106- <u>X</u> 1D009	1.34mm	4106- <u>X</u> 1D34	7.7mm	4106- <u>X</u> 7D7	22.5mm	4106- <u>X</u> 22D5
1.01mm	4106- <u>X</u> 1D01	1.35mm	4106- <u>X</u> 1D35	8mm	4106- <u>X</u> 8	22.8mm	4106- <u>X</u> 22D8
1.02mm	4106- <u>X</u> 1D02	1.36mm	4106- <u>X</u> 1D36	8.5mm	4106- <u>X</u> 8D5	23mm	4106- <u>X</u> 23
1.03mm	4106- <u>X</u> 1D03	1.37mm	4106- <u>X</u> 1D37	9mm	4106- <u>X</u> 9	23.5mm	4106- <u>X</u> 23D5
1.04mm	4106- <u>X</u> 1D04	1.38mm	4106- <u>X</u> 1D38	9.5mm	4106- <u>X</u> 9D5	24mm	4106- <u>X</u> 24
1.05mm	4106- <u>X</u> 1D05	1.39mm	4106- <u>X</u> 1D39	10mm	4106- <u>X</u> 10	24.5mm	4106- <u>X</u> 24D5
1.06mm	4106- <u>X</u> 1D06	1.4mm	4106- <u>X</u> 1D4	10.3mm	4106- <u>X</u> 10D3	25mm	4106- <u>X</u> 25
1.07mm	4106- <u>X</u> 1D07	1.41mm	4106- <u>X</u> 1D41	10.5mm	4106- <u>X</u> 10D5	30mm	4106- <u>X</u> 30
1.08mm	4106- <u>X</u> 1D08	1.42mm	4106- <u>X</u> 1D42	11mm	4106- <u>X</u> 11	40mm	4106- <u>X</u> 40
1.09mm	4106- <u>X</u> 1D09	1.43mm	4106- <u>X</u> 1D43	11.5mm	4106- <u>X</u> 11D5	41.3mm	4106- <u>X</u> 41D3
1.1mm	4106- <u>X</u> 1D1	1.44mm	4106- <u>X</u> 1D44	12mm	4106- <u>X</u> 12	50mm	4106- <u>X</u> 50
1.11mm	4106- <u>X</u> 1D11	1.45mm	4106- <u>X</u> 1D45	12.5mm	4106- <u>X</u> 12D5	60mm	4106- <u>X</u> 60
1.12mm	4106- <u>X</u> 1D12	1.46mm	4106- <u>X</u> 1D46	12.9mm	4106- <u>X</u> 12D9	70mm	4106- <u>X</u> 70
1.13mm	4106- <u>X</u> 1D13	1.47mm	4106- <u>X</u> 1D47	13mm	4106- <u>X</u> 13	75mm	4106- <u>X</u> 75
1.14mm	4106- <u>X</u> 1D14	1.48mm	4106- <u>X</u> 1D48	13.5mm	4106- <u>X</u> 13D5	80mm	4106- <u>X</u> 80
1.15mm	4106- <u>X</u> 1D15	1.49mm	4106- <u>X</u> 1D49	14mm	4106- <u>X</u> 14	90mm	4106- <u>X</u> 90
1.16mm	4106- <u>X</u> 1D16	1.5mm	4106- <u>X</u> 1D5	14.5mm	4106- <u>X</u> 14D5	100mm	4106- <u>X</u> 100
1.17mm	4106- <u>X</u> 1D17	1.6mm	4106- <u>X</u> 1D6	15mm	4106- <u>X</u> 15	125mm	4106- <u>X</u> 125
1.18mm	4106- <u>X</u> 1D18	1.7mm	4106- <u>X</u> 1D7	15.5mm	4106- <u>X</u> 15D5	131.4mm	4106- <u>X</u> 131D4
1.19mm	4106- <u>X</u> 1D19	1.8mm	4106- <u>X</u> 1D8	16mm	4106- <u>X</u> 16	150mm	4106- <u>X</u> 150
1.2mm	4106- <u>X</u> 1D2	1.9mm	4106- <u>X</u> 1D9	16.5mm	4106- <u>X</u> 16D5		
1.21mm	4106- <u>X</u> 1D21	2mm	4106- <u>X</u> 2	17mm	4106- <u>X</u> 17		
1.22mm	4106- <u>X</u> 1D22	2.5mm	4106- <u>X</u> 2D5	17.5mm	4106- <u>X</u> 17D5		



STEEL GAGE BLOCK SETS

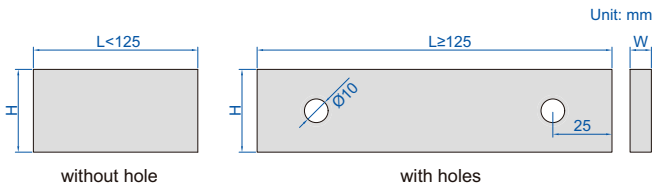

Dimension:

Size (L)	W	H
0.5 ≤ L ≤ 10mm	9mm	30mm
L > 10mm	9mm	35mm

Code example:
“-122” stands for “4100-122”

- Made of alloy steel
- Meet ISO3650
- Gage blocks ≥ 125mm have clamping holes
- Supplied with manufacturer inspection certificate



POPULAR MODEL

4100-87

Blocks per set	Gage blocks included in set			Code (4100)		
	Size (mm)	Step (mm)	Quantity	Grade 0	Grade 1	Grade 2
122	1.0005		1			
	1.001-1.009	0.001	9			
	1.01-1.49	0.01	49			
	1.6-1.9	0.1	4	-122	-1122	-2122
	0.5-24.5	0.5	49			
	30-100	10	8			
	25-75	50	2			
112	1.0005		1			
	1.001-1.009	0.001	9			
	1.01-1.49	0.01	49	-112	-1112	-2112
	0.5-24.5	0.5	49			
	25-100	25	4			
103	1.005		1			
	1.01-1.49	0.01	49	-103	-1103	-2103
	0.5-24.5	0.5	49			
	25-100	25	4			
88	1.0005		1			
	1.001-1.009	0.001	9			
	1.01-1.49	0.01	49	-88	-188	-288
	0.5-9.5	0.5	19			
	10-100	10	10			
87	1.001-1.009	0.001	9			
	1.01-1.49	0.01	49	-87	-187	-287
	0.5-9.5	0.5	19			
	10-100	10	10			
83	0.5		1			
	1		1			
	1.005		1			
	1.01-1.49	0.01	49	-83	-183	-283
	1.5-1.9	0.1	5			
	2-9.5	0.5	16			
	10-100	10	10			
76	1.005		1			
	1.01-1.49	0.01	49			
	0.5-9.5	0.5	19	-76	-176	-276
	10-40	10	4			
	50-100	25	3			

Blocks per set	Gage blocks included in set			Code (4100)		
	Size (mm)	Step (mm)	Quantity	Grade 0	Grade 1	Grade 2
56	0.5		1			
	1.001-1.009	0.001	9			
	1.01-1.09	0.01	9			
	1.1-1.9	0.1	9	-56	-156	-256
	1-24	1	24			
	25-100	25	4			
47	1.005		1			
	1.01-1.09	0.01	9			
	1.1-1.9	0.1	9	-47A	-147A	-247A
	1-24	1	24			
47	1.005		1			
	1.01-1.19	0.01	19			
	1.2-1.9	0.1	8	-47	-147	-247
	1-9	1	9			
	10-100	10	10			
46	1.001-1.009	0.001	9			
	1.01-1.09	0.01	9			
	1.1-1.9	0.1	9	-46	-146	-246
	1-9	1	9			
	10-100	10	10			
34	1.0005		1			
	1.001-1.009	0.001	9			
	1.01-1.09	0.01	9			
	1.1-1.9	0.1	9	-34	-134	-234
	1-5	1	5			
32	10		1			
	1.005		1			
	1.01-1.09	0.01	9			
	1.1-1.9	0.1	9			
	1-9	1	9	-32	-132	-232
	10-30	10	3			
	50		1			
9	1.001-1.009	0.001	9	-9	-19	-29
9	0.991-0.999	0.001	9	-9A	-19A	-29A
8	125-175	25	3			
	200-250	50	2	-8	-18	-28
	300-500	100	3			

STEEL INDIVIDUAL GAGE BLOCKS

CUSTOM-MADE
CAN SUPPLY ANY SIZES FROM
0.5 TO 1000MM, SUCH AS 72.672MM



- Grade 0, 1 and 2 gage blocks are available
- Made of alloy steel
- Meet ISO3650
- Gage blocks with clamping holes: 125, 150, 175, 200, 250, 300, 400, 500, 600, 700, 800, 900, 1000mm
- Supplied with manufacturer inspection certificate



4101-A70

4101-A200

Unit: mm

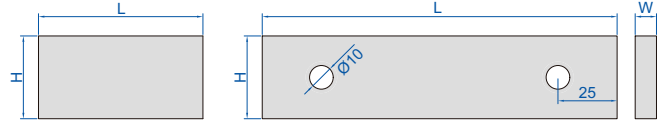

without hole

with holes

Code explanation:

4101-X□□□□□

- A for grade 0
- B for grade 1
- C for grade 2

Code examples:

Size (L)	Grade	Code
0.5mm	0	4101-AD5
1mm	1	4101-B1
10.5mm	2	4101-C10D5

Dimension:

Size (L)	W	H
0.5 ≤ L ≤ 10mm	9mm	30mm
L > 10mm	9mm	35mm

13

Size	Code	Size	Code	Size	Code	Size	Code
0.5mm	4101-XD5	1.19mm	4101-X1D19	3.5mm	4101-X3D5	20.2mm	4101-X20D2
0.991mm	4101-XD991	1.2mm	4101-X1D2	4mm	4101-X4	20.5mm	4101-X20D5
0.992mm	4101-XD992	1.21mm	4101-X1D21	4.5mm	4101-X4D5	21mm	4101-X21
0.993mm	4101-XD993	1.22mm	4101-X1D22	5mm	4101-X5	21.5mm	4101-X21D5
0.994mm	4101-XD994	1.23mm	4101-X1D23	5.1mm	4101-X5D1	22mm	4101-X22
0.995mm	4101-XD995	1.24mm	4101-X1D24	5.5mm	4101-X5D5	22.5mm	4101-X22D5
0.996mm	4101-XD996	1.25mm	4101-X1D25	6mm	4101-X6	22.8mm	4101-X22D8
0.997mm	4101-XD997	1.26mm	4101-X1D26	6.5mm	4101-X6D5	23mm	4101-X23
0.998mm	4101-XD998	1.27mm	4101-X1D27	7mm	4101-X7	23.5mm	4101-X23D5
0.999mm	4101-XD999	1.28mm	4101-X1D28	7.5mm	4101-X7D5	24mm	4101-X24
1mm	4101-X1	1.29mm	4101-X1D29	7.7mm	4101-X7D7	24.5mm	4101-X24D5
1.0005mm	4101-X1D0005	1.3mm	4101-X1D3	8mm	4101-X8	25mm	4101-X25
1.001mm	4101-X1D001	1.31mm	4101-X1D31	8.5mm	4101-X8D5	30mm	4101-X30
1.002mm	4101-X1D002	1.32mm	4101-X1D32	9mm	4101-X9	35mm	4101-X35
1.003mm	4101-X1D003	1.33mm	4101-X1D33	9.5mm	4101-X9D5	40mm	4101-X40
1.004mm	4101-X1D004	1.34mm	4101-X1D34	10mm	4101-X10	41.3mm	4101-X41D3
1.005mm	4101-X1D005	1.35mm	4101-X1D35	10.3mm	4101-X10D3	45mm	4101-X45
1.006mm	4101-X1D006	1.36mm	4101-X1D36	10.5mm	4101-X10D5	50mm	4101-X50
1.007mm	4101-X1D007	1.37mm	4101-X1D37	11mm	4101-X11	60mm	4101-X60
1.008mm	4101-X1D008	1.38mm	4101-X1D38	11.5mm	4101-X11D5	70mm	4101-X70
1.009mm	4101-X1D009	1.39mm	4101-X1D39	12mm	4101-X12	75mm	4101-X75
1.01mm	4101-X1D01	1.4mm	4101-X1D4	12.5mm	4101-X12D5	80mm	4101-X80
1.02mm	4101-X1D02	1.41mm	4101-X1D41	12.9mm	4101-X12D9	90mm	4101-X90
1.03mm	4101-X1D03	1.42mm	4101-X1D42	13mm	4101-X13	100mm	4101-X100
1.04mm	4101-X1D04	1.43mm	4101-X1D43	13.5mm	4101-X13D5	125mm	4101-X125
1.05mm	4101-X1D05	1.44mm	4101-X1D44	14mm	4101-X14	131.4mm	4101-X131D4
1.06mm	4101-X1D06	1.45mm	4101-X1D45	14.5mm	4101-X14D5	150mm	4101-X150
1.07mm	4101-X1D07	1.46mm	4101-X1D46	15mm	4101-X15	175mm	4101-X175
1.08mm	4101-X1D08	1.47mm	4101-X1D47	15.5mm	4101-X15D5	200mm	4101-X200
1.09mm	4101-X1D09	1.48mm	4101-X1D48	16mm	4101-X16	250mm	4101-X250
1.1mm	4101-X1D1	1.49mm	4101-X1D49	16.5mm	4101-X16D5	300mm	4101-X300
1.11mm	4101-X1D11	1.5mm	4101-X1D5	17mm	4101-X17	400mm	4101-X400
1.12mm	4101-X1D12	1.6mm	4101-X1D6	17.5mm	4101-X17D5	500mm	4101-X500
1.13mm	4101-X1D13	1.7mm	4101-X1D7	17.6mm	4101-X17D6	600mm	4101-X600
1.14mm	4101-X1D14	1.8mm	4101-X1D8	18mm	4101-X18	700mm	4101-X700
1.15mm	4101-X1D15	1.9mm	4101-X1D9	18.5mm	4101-X18D5	750mm	4101-X750
1.16mm	4101-X1D16	2mm	4101-X2	19mm	4101-X19	800mm	4101-X800
1.17mm	4101-X1D17	2.5mm	4101-X2D5	19.5mm	4101-X19D5	900mm	4101-X900
1.18mm	4101-X1D18	3mm	4101-X3	20mm	4101-X20	1000mm	4101-X1000



CARBIDE GAGE BLOCK SETS

- Made of carbide, extremely wear resistance and corrosion resistance, excellent dimension stability
- Meet ISO3650
- Supplied with manufacturer inspection certificate



4164-32

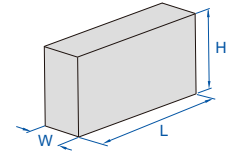

Dimension:

Size(L)	W	H
0.5 ≤ L ≤ 10mm	9mm	30mm
L > 10mm	9mm	35mm

Blocks per set	Gage blocks included in set			Code	
	Size (mm)	Step (mm)	Quantity	Grade 0	Grade 1
122	1.0005		1	4164-122	4164-1122
	1.001-1.009	0.001	9		
	1.01-1.49	0.01	49		
	1.6-1.9	0.1	4		
	0.5-24.5	0.5	49		
	30-100	10	8		
	25-75	50	2		
112	1.0005		1	4164-112	4164-1112
	1.001-1.009	0.001	9		
	1.01-1.49	0.01	49		
	0.5-24.5	0.5	49		
	25-100	25	4		
103	1.005		1	4164-103	4164-1103
	1.01-1.49	0.01	49		
	0.5-24.5	0.5	49		
	25-100	25	4		
	1.001-1.009	0.001	9		
87	1.01-1.49	0.01	49	4164-87	4164-187
	0.5-9.5	0.5	19		
	10-100	10	10		
	0.5		1		
	1		1		
83	1.005		1	4164-83	4164-183
	1.01-1.49	0.01	49		
	1.5-1.9	0.1	5		
	2-9.5	0.5	16		
	10-100	10	10		

Blocks per set	Gage blocks included in set			Code	
	Size (mm)	Step (mm)	Quantity	Grade 0	Grade 1
76	1.005		1	4164-76	4164-176
	1.01-1.49	0.01	49		
	0.5-9.5	0.5	19		
	10-40	10	4		
	50-100	25	3		
47	1.005		1	4164-47A	4164-147A
	1.01-1.09	0.01	9		
	1.1-1.9	0.1	9		
	1-24	1	24		
47	1.005		1	4164-47	4164-147
	1.01-1.19	0.01	19		
	1.2-1.9	0.1	8		
	1-9	1	9		
	10-100	10	10		
46	1.001-1.009	0.001	9	4164-46	4164-146
	1.01-1.09	0.01	9		
	1.1-1.9	0.1	9		
	1-9	1	9		
	10-100	10	10		
32	1.005		1	4164-32	4164-132
	1.01-1.09	0.01	9		
	1.1-1.9	0.1	9		
	1-9	1	9		
	10-30	10	3		
	50		1		

13

CALIPER INSPECTION GAGE BLOCK SET



4108-3005

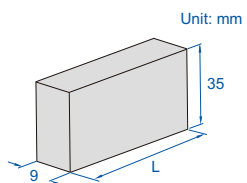

- Meet ISO3650/grade 2
- Supplied with manufacturer inspection certificate

Code	Material	Gage blocks included in set (L)	Applicable calipers
4108-3005	alloy steel	30, 41.3, 131.4, 243.5, 281.2	0-150, 0-200, 0-300

CALIPER INSPECTION GAGE BLOCK AND RING GAGE SETS

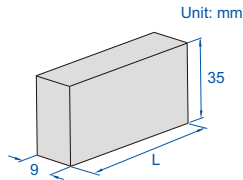

4176-30

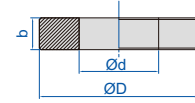

Ring gage sizes:

diameter (Ød)*	b	ØD
Ø4mm	5mm	22mm
Ø25mm	14mm	53mm

* The size of the ring gage when supplied may have deviation. For example, the size Ø25mm may be 24.996mm

- Gage blocks meet ISO3650
Ring gages meet DIN2250-1:2008
- Supplied with manufacturer inspection certificate

13

Grade of gage blocks: 2

Code	Material	Gage blocks included in set (L)	Ring gages included in set (Ød)	Applicable calipers
4176-30	alloy steel	30, 41.3, 131.4	4, 25	0-150

Grade of gage blocks: 1

Code	Material	Gage blocks included in set (L)	Ring gages included in set (Ød)	Applicable calipers
4176-301	alloy steel	30, 41.3, 131.4	4, 25	0-150

MICROMETER INSPECTION GAGE BLOCK SETS



- One piece of optical flat is included in **4107-10** and **4107-101**
- Meet ISO3650/grade 0
- Supplied with manufacturer inspection certificate



4107-10

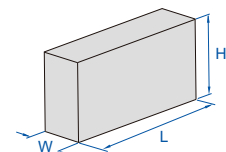

Dimension:

Size (L)	W	H
0.5 ≤ L ≤ 10mm	9mm	30mm
L > 10mm	9mm	35mm

Code	Material	Gage blocks included in set (mm)	Applicable micrometer	Optical flat
4107-10	ceramic	2.5, 5.1, 7.7, 10.3, 12.9, 15, 17.6, 20.2, 22.8, 25, optical flat	0-25mm	included
4107-101	alloy steel	2.5, 5.1, 7.7, 10.3, 12.9, 15, 17.6, 20.2, 22.8, 25, optical flat	0-25mm	included
4107-112	alloy steel	25, 27.5, 30.1, 32.7, 35.3, 37.9, 40, 42.6, 45.2, 47.8, 50	25-50mm	not included
4107-113	alloy steel	50, 52.5, 55.1, 57.7, 60.3, 62.9, 65, 67.6, 70.2, 72.8, 75	50-75mm	not included
4107-114	alloy steel	75, 77.5, 80.1, 82.7, 85.3, 87.9, 90, 92.6, 95.2, 97.8, 100	75-100mm	not included
4107-115	alloy steel	5.12, 10.24, 15.36, 21.5, 25, 30.12, 35.24, 40.36, 46.5, 50, 55.12, 60.24, 65.36, 71.5, 75, 80.12, 85.24, 90.36, 96.5, 100	0-100mm	not included



MICROMETER INSPECTION GAGE BLOCK SET

application



4160-10

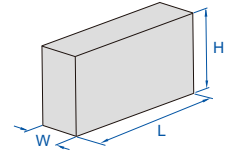

Dimension:

Size (L)	W	H
0.5 ≤ L ≤ 10mm	9mm	30mm
L > 10mm	9mm	35mm

optical flat (included)



- Meet ISO3650/grade 0
- One piece of optical flat is included (size Ø30x12mm)
- Supplied with manufacturer inspection certificate

Code	Material	Gage blocks included in set	Applicable micrometer
4160-10	alloy steel	2.5mm, 5.1mm, 7.7mm, 10.3mm, 12.9mm, 15mm, 17.6mm, 20.2mm, 22.8mm, 25mm	0-25mm

GAGE BLOCK HOLDERS

- Made of aluminum
- To be used with individual steel gage blocks (code 4101) as Go and No-Go gage

Code	Applicable gage block size
6883-1	1.5-5mm
6883-2	5-10mm
6883-3	10-15mm
6883-4	15-20mm
6883-5	20-25mm



6883-4

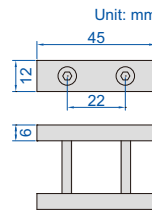

to be used as Go and No-Go gage



GAGE BLOCK HOLDER

- For gage blocks over 125mm with clamping holes
- Optional accessory: gage block holder accessory, gage block accessory (code 6881)

Code
6886-1



6886-1

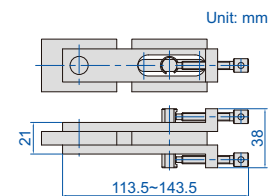

GAGE BLOCK HOLDER ACCESSORY

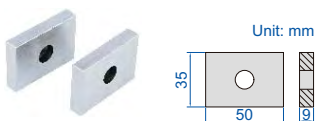

Code
6886-A

6886-A

application

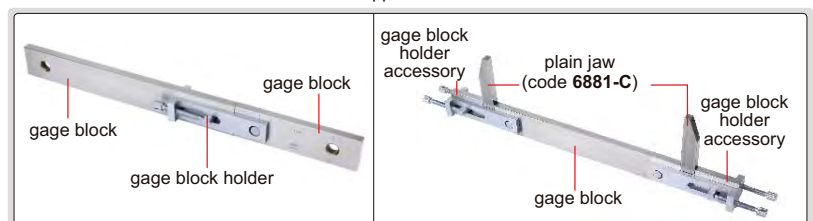

GAGE BLOCK ACCESSORIES

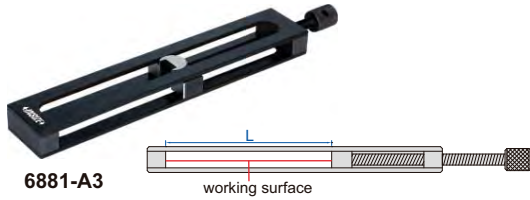

6881-A3

Code	Name	Clamping range* (L)
6881-A1	holder	0-25mm
6881-A2	holder	25-50mm
6881-A3	holder	50-100mm
6881-A4	holder	100-200mm
6881-A5	holder	200-300mm
6881-A6**	holder	300-500mm
6881-A7**	holder	500-750mm
6881-A8**	holder	750-1000mm

*The actual clamping range should deduct the width of jaws
 ** Not suitable for base 6881-B

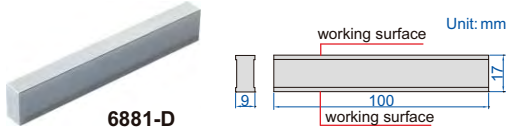

6881-D

Code	Name	Remark
6881-D	parallel jaw	made of carbide



6881-S17

GAGE BLOCK ACCESSORY SET

Code	Remark
6881-S17	17 pcs (including below items)

holder, 0-25mm (code 6881-A1)	1 pc
holder, 25-50mm (code 6881-A2)	1 pc
holder, 50-100mm (code 6881-A3)	1 pc
holder, 100-200mm (code 6881-A4)	1 pc
holder, 200-300mm (code 6881-A5)	1 pc
base (code 6881-B)	1 pc
plain jaw (code 6881-C)	1 pair
parallel jaw (code 6881-D)	1 pc
half round jaw, 2.5mm (code 6881-E1)	1 pair
half round jaw, 5.0mm (code 6881-E2)	1 pair
half round jaw, 6.0mm (code 6881-E3)	1 pair
scraper (code 6881-F)	1 pc
centre point (code 6881-G)	1 pc



6881-B

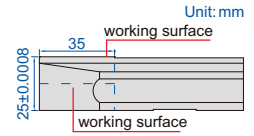

6881-E2

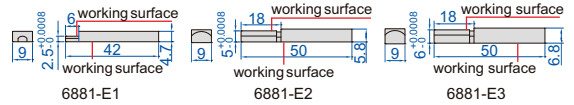

Code	Name	Size	Remark
6881-E1	half round jaw	2.5mm	made of carbide, supplied in pair
6881-E2	half round jaw	5.0mm	made of carbide, supplied in pair
6881-E3	half round jaw	6.0mm	made of carbide, supplied in pair



6881-C

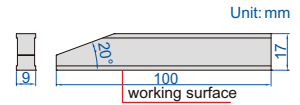

Code	Name	Remark
6881-C	plain jaw	made of carbide, supplied in pair



6881-F

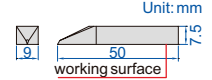

Code	Name	Remark
6881-F	scraper	made of carbide



6881-G

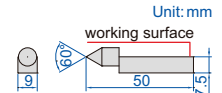

Code	Name	Remark
6881-G	centre point	the tip is made of carbide

application

<p>(plain jaw+holder) set zero for bore gage and inside micrometers</p>	<p>(base+holder+scraper) measure height or scribe</p>	<p>(half round jaw+holder) measure inside diameter</p>
<p>(scraper+centre point+holder) scribe circle</p>	<p>(plain jaw+parallel jaw+holder) Go and No Go inspection</p>	



CUSTOM-MADE
CAN SUPPLY ANY LENGTH, SUCH AS 80.672MM

CYLINDER GAGE BLOCKS

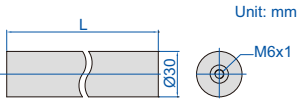

- Made of special alloy steel, hardness HRC64, high stability, wear resistance and easy combination
- Meet ISO3650 grade 1
- Can be connected with M6x1 screw and combined to any sizes up to 4m

can be combined to any sizes up to 4m

Combination 1: combined by several standard size cylinder gage blocks and one custom size cylinder gage block
For example: 500 (standard) + 200 (standard) + 25.832 (custom)=725.832mm
Note: in order to reduce cost, custom size should be within 100mm

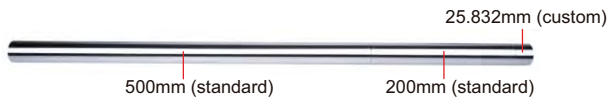

Combination 2: combined by standard size cylinder gage blocks and rectangular gage blocks
For example: 500 (cylinder) + 200 (cylinder) + 21.5 (rectangular) + 2.33 (rectangular) + 2.002 (rectangular)=725.832mm

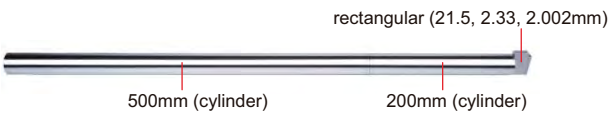

Code	Length (L)
4001-25 *	25mm
4001-50 *	50mm
4001-75 *	75mm
4001-100 *	100mm
4001-200 *	200mm
4001-300 *	300mm
4001-400 *	400mm
4001-500 *	500mm

* Supplied with manufacturer inspection certificate

high stability in vertical position, suitable for checking height gages



connected with M6x1mm screw

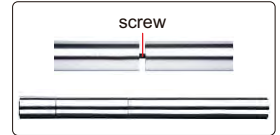

INTERNAL BLOCKS



4001-A

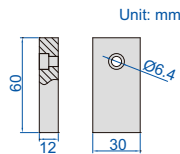

- Can be attached to cylinder and rectangular gage blocks
- Made of special alloy steel, hardness HRC64, high stability, wear resistance and easy combination
- Supplied in a matched pair

Code	Size	Flatness
4001-A	12mm	0.2µm

Combination 1: combined by several standard size cylinder gage blocks and one custom size cylinder gage block
For example: 500 (standard) + 200 (standard) + 25.832 (custom)=725.832mm
Note: in order to reduce cost, custom size should be within 100mm



Combination 2: combined by standard size cylinder gage blocks and rectangular gage blocks
For example: 500 (cylinder) + 200 (cylinder) + 50 (rectangular) - 20 (rectangular) - 2.16 (rectangular) - 2.008 (rectangular)=725.832mm

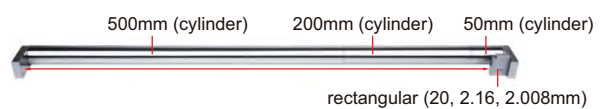

BASE



4001-B

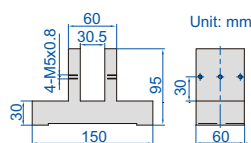

Code	Remark
4001-B	supplied in pair

working with base

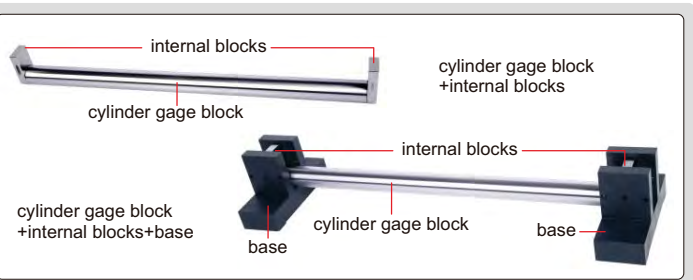

CMM CHECK MASTERS



6882-600A

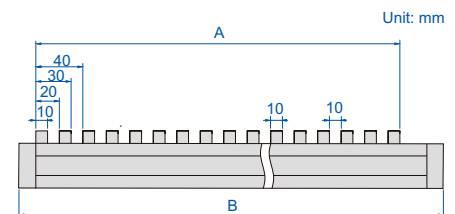

- To check the accuracy of table movements of machine tools and calibrate CMM
- Horizontal use and vertical use
- Constructed with ceramic gage blocks
- Can be used with stand
- Optional accessory: stand (code **6877**)

13

Standard accuracy

Code	Size	Step	A	B
6882-300A *	0-300mm	10mm	310mm	350mm
6882-400A *	0-400mm	10mm	410mm	450mm
6882-500A *	0-500mm	10mm	510mm	550mm
6882-600A *	0-600mm	10mm	610mm	650mm
6882-1000A *	0-1000mm	10mm	1010mm	1050mm

High accuracy

Code	Size	Step	A	B
6882-300H *	0-300mm	10mm	310mm	350mm
6882-400H *	0-400mm	10mm	410mm	450mm
6882-500H *	0-500mm	10mm	510mm	550mm
6882-600H *	0-600mm	10mm	610mm	650mm
6882-1000H *	0-1000mm	10mm	1010mm	1050mm

* Supplied with manufacturer inspection certificate

Accuracy

Range (mm)	Standard accuracy	High accuracy
≤300	±1.3μm	±0.8μm
>300, ≤400	±1.6μm	±1.0μm
>400, ≤500	±2.0μm	±1.0μm
>500, ≤600	±2.5μm	±1.0μm
>600, ≤800	±3.0μm	±2.5μm
>800, ≤1000	±4.0μm	±2.5μm



horizontal use



can be used with stand (optional)



CMM CHECK MASTERS (ADVANCED TYPE)



6874-1000

- To check the accuracy of table movements of machine tools and calibrate CMM
- Horizontal use and vertical use
- Constructed with ceramic gage blocks
- Can be used with stand
- Optional accessory: stand (code **6874**)

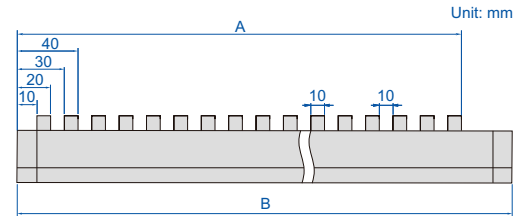

13

Code	Size	Step	A	B
6874-300 *	0-300mm	10mm	320mm	345mm
6874-450 *	0-450mm	10mm	470mm	495mm
6874-600 *	0-600mm	10mm	620mm	645mm
6874-1000 *	0-1000mm	10mm	1020mm	1045mm

* Supplied with ISO17025 calibration certificate of Shenzhen Institute of Metrology&Quality Inspection (SMQ)



ISO17025 calibration certificate

Accuracy

Range (mm)	Accuracy	Work face size variation
≤100	±1.0μm	0.5μm
>100, ≤200	±1.1μm	0.5μm
>200, ≤300	±1.3μm	0.6μm
>300, ≤400	±1.6μm	0.7μm
>400, ≤500	±2.0μm	0.8μm
>500, ≤600	±2.5μm	1.0μm
>600, ≤800	±3.0μm	1.4μm
>800, ≤1000	±4.0μm	1.8μm

Stand (optional)

Code	Applicable check masters
6874-A	6874-300, 6874-450, 6874-600
6874-B	6874-1000



can be used with stand (optional)

CALIPER/HEIGHT GAGE CHECKERS

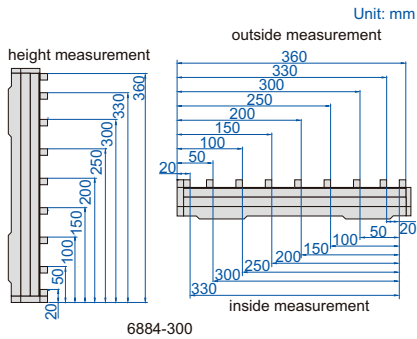

horizontal use



vertical use

6884-300

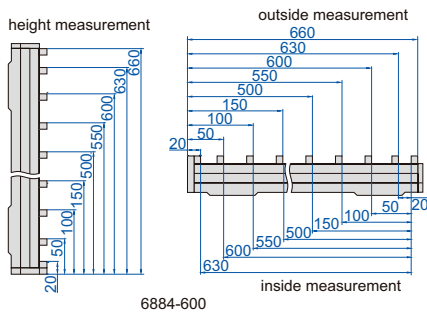

- To check calipers and height gages
- Constructed with steel gage blocks

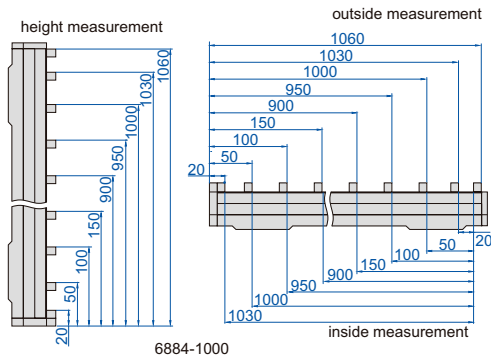

check upper jaws of calipers

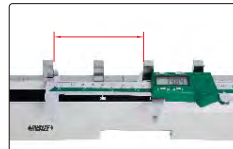

check lower jaws of calipers

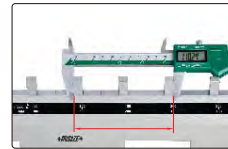

check height gages



Code	Size	Range of inside measurement	Range of outside measurement	Range of height measurement	Accuracy (mm)
6884-300*	0-300mm	20, 50, 100, 150, 200, 250, 300, 330	20, 50, 100, 150, 200, 250, 300, 330, 360	20, 50, 100, 150, 200, 250, 300, 330, 360	±3µm
6884-600*	0-600mm	20, 50, 100, 150, 200, 250, 300, 350, 400, 450, 500, 550, 600, 630	20, 50, 100, 150, 200, 250, 300, 350, 400, 450, 500, 550, 600, 630, 660	20, 50, 100, 150, 200, 250, 300, 350, 400, 450, 500, 550, 600, 630, 660	±5µm
6884-1000*	0-1000mm	20, 50, 100, 150, 200, 250, 300, 350, 400, 450, 500, 550, 600, 650, 700, 750, 800, 850, 900, 950, 1000, 1030	20, 50, 100, 150, 200, 250, 300, 350, 400, 450, 500, 550, 600, 650, 700, 750, 800, 850, 900, 950, 1000, 1030, 1060	20, 50, 100, 150, 200, 250, 300, 350, 400, 450, 500, 550, 600, 650, 700, 750, 800, 850, 900, 950, 1000, 1030, 1060	±7µm

*Supplied with manufacturer inspection certificate

INSIDE MICROMETER ACCESSORY

- Supplied with a pair of 5mm carbide gage blocks

Code
6884-A10*



6884-A10

*Supplied with manufacturer inspection certificate

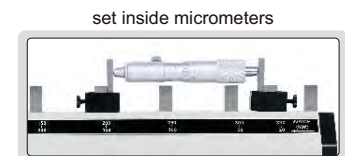



4002-15

ANGLE GAGE BLOCKS

Unit: mm

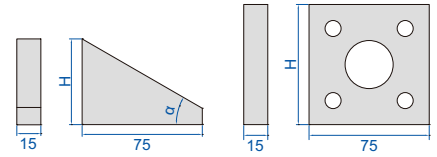

inspect angle

set angle of plate

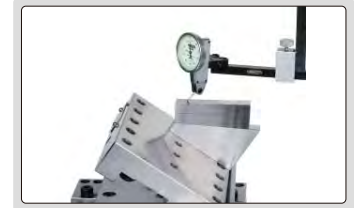

combination

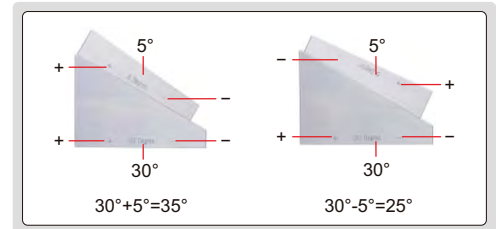

Individual

Code	Angle (α)	H (mm)
4002-A1 *	1°	11.5
4002-A3 *	3°	14.0
4002-A5 *	5°	16.5
4002-A9 *	9°	22.0
4002-A15 *	15°	30.5
4002-A27 *	27°	48.0
4002-A30 *	30°	53.5
4002-A41 *	41°	75.0
4002-A45 *	45°	84.0
4002-B1 *	1'	10.0
4002-B3 *	3'	10.0
4002-B5 *	5'	10.0
4002-B9 *	9'	10.0
4002-B20 *	20'	10.0
4002-B27 *	27'	10.0
4002-B30 *	30'	10.0
4002-C6 *	6"	10.0
4002-C12 *	12"	10.0
4002-C18 *	18"	10.0
4002-C30 *	30"	10.0
4002-D *	90°/90°/90°/90°	75.0

- Accuracy: ±2"
- To inspect protractor, taper gage, index plate, index head and goniometer, can also be used to set angle
- Made of special alloy steel, hardness HRC64, high stability, wear resistance and easy combination
- Can be combined to any angle with interval 6 seconds after combination (6", 12", 18", ... , 360°)

Set

Code	Angle (α)	Total quantity
4002-13 *	1°, 3°, 9°, 27°, 41°, 1', 3', 9', 27', 6", 18", 30", 90°/90°/90°/90°	13
4002-15 *	1°, 3°, 5°, 15°, 30°, 45°, 1', 3', 5', 20', 30', 6", 12", 30", 90°/90°/90°/90°	15

*Supplied with manufacturer inspection certificate

Code	Taper
6328-BT30	BT30
6328-BT40	BT40
6328-BT45	BT45
6328-BT50	BT50
6328-BT55	BT55

Code	Taper
6328-BT60	BT60
6328-BT65	BT65
6328-BT70	BT70
6328-BT75	BT75
6328-BT80	BT80

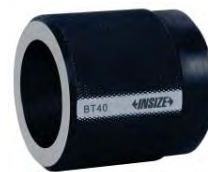

6328-BT40

TAPER RING GAGES

Code	Taper
6329-BT30	BT30
6329-BT40	BT40
6329-BT45	BT45
6329-BT50	BT50
6329-BT55	BT55

Code	Taper
6329-BT60	BT60
6329-BT65	BT65
6329-BT70	BT70
6329-BT75	BT75
6329-BT80	BT80



6329-BT40

TAPER PLUG GAGES

CARBIDE PIN GAGE SETS

- Meet DIN2269, grade 1
- Made of carbide
- Hardness HRA90-90.5
- Diameter accuracy: $\pm 1\mu\text{m}$



4194-10D

Unit: mm



Code	Diameter $\varnothing d$ (mm)	Step	Pin gages per set
4194-1S	0.30, 0.31, 0.32, ..., 1.00	0.01mm	71
4194-2S	1.00, 1.01, 1.02, ..., 2.00	0.01mm	101
4194-3S	2.00, 2.01, 2.02, ..., 3.00	0.01mm	101
4194-4S	3.00, 3.01, 3.02, ..., 4.00	0.01mm	101
4194-5S	4.00, 4.01, 4.02, ..., 5.00	0.01mm	101
4194-6S	5.00, 5.01, 5.02, ..., 6.00	0.01mm	101
4194-7S	6.00, 6.01, 6.02, ..., 7.00	0.01mm	101
4194-8S	7.00, 7.01, 7.02, ..., 8.00	0.01mm	101
4194-9S	8.00, 8.01, 8.02, ..., 9.00	0.01mm	101
4194-10S	9.00, 9.01, 9.02, ..., 10.00	0.01mm	101
4194-10D	10.00, 10.01, 10.02, ..., 10.50	0.01mm	51
4194-11	10.50, 10.51, 10.52, ..., 11.00	0.01mm	51
4194-11D	11.00, 11.01, 11.02, ..., 11.50	0.01mm	51
4194-12	11.50, 11.51, 11.52, ..., 12.00	0.01mm	51
4194-12D	12.00, 12.01, 12.02, ..., 12.50	0.01mm	51
4194-13	12.50, 12.51, 12.52, ..., 13.00	0.01mm	51
4194-13D	13.00, 13.01, 13.02, ..., 13.50	0.01mm	51
4194-14	13.50, 13.51, 13.52, ..., 14.00	0.01mm	51
4194-14D	14.00, 14.01, 14.02, ..., 14.50	0.01mm	51
4194-15	14.50, 14.51, 14.52, ..., 15.00	0.01mm	51

CARBIDE INDIVIDUAL PIN GAGES



- Meet DIN2269, grade 1
- Diameter range: $\varnothing 0.300\text{--}\varnothing 30.000\text{mm}$ with three decimal, for example 0.311mm, 5.562mm, 16.298mm
- Diameter accuracy: $\pm 1\mu\text{m}$
- Made of carbide
- Hardness HRA90-90.5
- Optional accessory: wooden box (code 7340)



Unit: mm



Ordering examples:

Diameter	Code
0.311mm	4193-0D311
5.562mm	4193-5D562
16.298mm	4193-16D298

Note: "D" stands for "."

4193-8D015

Code	Diameter range $\varnothing d$ (mm)
4193-□□□□*	0.300~30.000

*Supplied with manufacturer inspection certificate



**POPULAR
MODEL**

STEEL PIN GAGE SETS

- Meet DIN2269, grade 1
- Made of alloy steel
- Hardness HRC62-65
- Diameter accuracy: $\pm 1\mu\text{m}$

Unit: mm

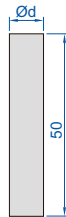

4166-10

13

Code	Diameter Ød (mm)	Step	Pin gages per set
4166-2S	1.00, 1.01, 1.02, ..., 2.00	0.01mm	101
4166-3S	2.00, 2.01, 2.02, ..., 3.00	0.01mm	101
4166-4S	3.00, 3.01, 3.02, ..., 4.00	0.01mm	101
4166-5S	4.00, 4.01, 4.02, ..., 5.00	0.01mm	101
4166-6S	5.00, 5.01, 5.02, ..., 6.00	0.01mm	101
4166-7S	6.00, 6.01, 6.02, ..., 7.00	0.01mm	101
4166-8S	7.00, 7.01, 7.02, ..., 8.00	0.01mm	101
4166-9S	8.00, 8.01, 8.02, ..., 9.00	0.01mm	101
4166-10S	9.00, 9.01, 9.02, ..., 10.00	0.01mm	101

Code	Diameter Ød (mm)	Step	Pin gages per set
4166-411	1.0, 1.1, 1.2, ..., 5.0	0.1mm	41
4166-511	5.0, 5.1, 5.2, ..., 10.0	0.1mm	51
4166-512	10.0, 10.1, 10.2, ..., 15.0	0.1mm	51
4166-513	15.0, 15.1, 15.2, ..., 20.0	0.1mm	51

Code	Diameter Ød (mm)	Step	Pin gages per set
4166-0D	0.20, 0.21, 0.22, ..., 0.50	0.01mm	31
4166-1	0.50, 0.51, 0.52, ..., 1.00	0.01mm	51
4166-1D	1.00, 1.01, 1.02, ..., 1.50	0.01mm	51
4166-2	1.50, 1.51, 1.52, ..., 2.00	0.01mm	51
4166-2D	2.00, 2.01, 2.02, ..., 2.50	0.01mm	51
4166-3	2.50, 2.51, 2.52, ..., 3.00	0.01mm	51
4166-3D	3.00, 3.01, 3.02, ..., 3.50	0.01mm	51
4166-4	3.50, 3.51, 3.52, ..., 4.00	0.01mm	51
4166-4D	4.00, 4.01, 4.02, ..., 4.50	0.01mm	51
4166-5	4.50, 4.51, 4.52, ..., 5.00	0.01mm	51
4166-5D	5.00, 5.01, 5.02, ..., 5.50	0.01mm	51
4166-6	5.50, 5.51, 5.52, ..., 6.00	0.01mm	51
4166-6D	6.00, 6.01, 6.02, ..., 6.50	0.01mm	51
4166-7	6.50, 6.51, 6.52, ..., 7.00	0.01mm	51
4166-7D	7.00, 7.01, 7.02, ..., 7.50	0.01mm	51
4166-8	7.50, 7.51, 7.52, ..., 8.00	0.01mm	51
4166-8D	8.00, 8.01, 8.02, ..., 8.50	0.01mm	51
4166-9	8.50, 8.51, 8.52, ..., 9.00	0.01mm	51
4166-9D	9.00, 9.01, 9.02, ..., 9.50	0.01mm	51
4166-10	9.50, 9.51, 9.52, ..., 10.00	0.01mm	51

Code	Diameter Ød (mm)	Step	Pin gages per set
4166-10D	10.00, 10.01, 10.02, ..., 10.50	0.01mm	51
4166-11	10.50, 10.51, 10.52, ..., 11.00	0.01mm	51
4166-11D	11.00, 11.01, 11.02, ..., 11.50	0.01mm	51
4166-12	11.50, 11.51, 11.52, ..., 12.00	0.01mm	51
4166-12D	12.00, 12.01, 12.02, ..., 12.50	0.01mm	51
4166-13	12.50, 12.51, 12.52, ..., 13.00	0.01mm	51
4166-13D	13.00, 13.01, 13.02, ..., 13.50	0.01mm	51
4166-14	13.50, 13.51, 13.52, ..., 14.00	0.01mm	51
4166-14D	14.00, 14.01, 14.02, ..., 14.50	0.01mm	51
4166-15	14.50, 14.51, 14.52, ..., 15.00	0.01mm	51
4166-15D	15.00, 15.01, 15.02, ..., 15.50	0.01mm	51
4166-16	15.50, 15.51, 15.52, ..., 16.00	0.01mm	51
4166-16D	16.00, 16.01, 16.02, ..., 16.50	0.01mm	51
4166-17	16.50, 16.51, 16.52, ..., 17.00	0.01mm	51
4166-17D	17.00, 17.01, 17.02, ..., 17.50	0.01mm	51
4166-18	17.50, 17.51, 17.52, ..., 18.00	0.01mm	51
4166-18D	18.00, 18.01, 18.02, ..., 18.50	0.01mm	51
4166-19	18.50, 18.51, 18.52, ..., 19.00	0.01mm	51
4166-19D	19.00, 19.01, 19.02, ..., 19.50	0.01mm	51
4166-20	19.50, 19.51, 19.52, ..., 20.00	0.01mm	51

STEEL INDIVIDUAL PIN GAGES WITH TWO DECIMAL PLACES (0.01MM STEP)

- Meet DIN2269, grade 1
- Diameter range: Ø0.20~Ø20.00mm
- Diameter accuracy: ±1µm
- Made of alloy steel
- Hardness HRC62-65
- Optional accessory: wooden box (code 7340)

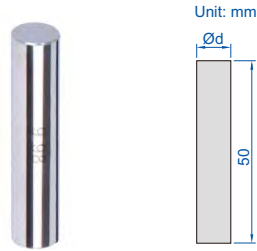

4110-9D98

Ordering examples:

Diameter	Code
0.21mm	4110-0D21
5.56mm	4110-5D56
16.00mm	4110-16D00

Note : "D" stands for "."

13

Diameter Ød (mm)
0.20, 0.21, 0.22, 0.23, … 1.00
1.01, 1.02, 1.03, 1.04, … 2.00
2.01, 2.02, 2.03, 2.04, … 3.00
3.01, 3.02, 3.03, 3.04, … 4.00
4.01, 4.02, 4.03, 4.04, … 5.00
5.01, 5.02, 5.03, 5.04, … 6.00
6.01, 6.02, 6.03, 6.04, … 7.00
7.01, 7.02, 7.03, 7.04, … 8.00
8.01, 8.02, 8.03, 8.04, … 9.00
9.01, 9.02, 9.03, 9.04, … 10.00

Diameter Ød (mm)
10.01, 10.02, 10.03, 10.04, … 11.00
11.01, 11.02, 11.03, 11.04, … 12.00
12.01, 12.02, 12.03, 12.04, … 13.00
13.01, 13.02, 13.03, 13.04, … 14.00
14.01, 14.02, 14.03, 14.04, … 15.00
15.01, 15.02, 15.03, 15.04, … 16.00
16.01, 16.02, 16.03, 16.04, … 17.00
17.01, 17.02, 17.03, 17.04, … 18.00
18.01, 18.02, 18.03, 18.04, … 19.00
19.01, 19.02, 19.03, 19.04, … 20.00

Code

4110-□□□□

STEEL INDIVIDUAL PIN GAGES WITH THREE DECIMAL PLACES (0.001MM STEP)



- Meet DIN2269, grade 1
- Diameter range: Ø0.200~Ø30.000mm with three decimal, for example 0.211mm, 5.562mm, 16.298mm
- Diameter accuracy: ±1µm
- Made of alloy steel
- Hardness HRC62-65
- Optional accessory: wooden box (code 7340)

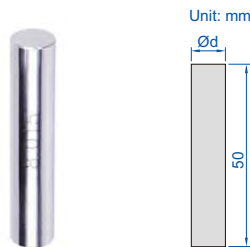

4118-8D015

Ordering examples:

Diameter	Code
0.211mm	4118-0D211
5.562mm	4118-5D562
16.298mm	4118-16D298

Note: "D" stands for "."

Code

4118-□□□□*

Diameter range Ød (mm)

0.200~30.000

* Supplied with manufacturer inspection certificate

CERAMIC INDIVIDUAL PIN GAGES

- Meet DIN2269, grade 1
- Diameter range: Ø1.000~Ø15.000mm
- With three decimal, for example 1.211mm, 5.562mm, 14.955mm
- Diameter accuracy: $\pm 1\mu\text{m}$
- Made of ceramic, extremely wear resistance, corrosion resistance and dimensional stability
- Optional accessory: wooden box (code **7340**)



4192-10D000

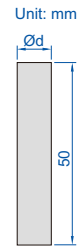

Ordering examples:

Diameter	Code
1.211mm	4192-1D211
5.562mm	4192-5D562
14.955mm	4192-14D955

Note : "D" stands for "."

Code	Diameter range Ød (mm)
4192-□□□□	1.000-15.000

BOXES FOR PIN GAGES

- For individual pin gages (**4110**, **4118**, **4192** and **4193** series)



7340

Code	Applicable pin gage diameter Ød	Quantity of pin gages
7340	0.20-10.00mm	51 pcs
7340-101	0.20-10.00mm	101 pcs
7340-201	10.00-15.00mm	51 pcs
7340-202	15.00-20.00mm	51 pcs

PIN GAGE HANDLES (OPERATED WITHOUT WRENCH)

- Operated without wrench
- Made of aluminum
- Pin gages can be installed



7342-M1

Code	Applicable pin gage diameter
7342-M0	0.30-1.50mm/0.011-0.060"
7342-M1	1.51-6.35mm/0.061-0.250"
7342-M2	6.36-12.70mm/0.251-0.500"
7342-M3	12.71-15.88mm/0.501-0.625"
7342-M4	15.89-19.00mm/0.626-0.750"
7342-M5	19.01-21.13mm/0.751-0.832"
7342-M6	21.14-23.27mm/0.833-0.916"
7342-M7	23.28-25.40mm/0.917-1.000"

application



PIN GAGE HANDLES (OPERATED WITH WRENCH)

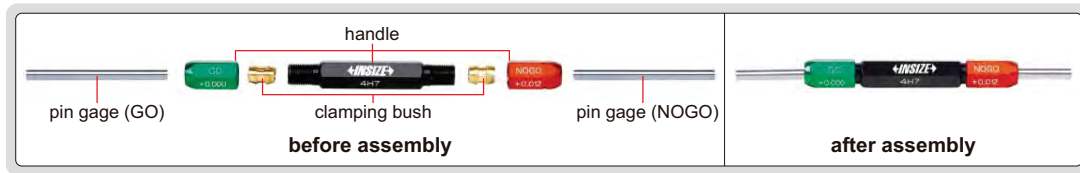

Handle



brass clamping bush
(0.2~7.14mm)



aluminum clamping bush
(7.14~24.80mm)

13

- Wrench is needed to install pins
- Clamping bushes (0.2~7.14mm) are made of brass, clamping bushes (7.14~24.80mm) are made of aluminum

Code	Applicable pin gage diameter	Including	
		handle	clamping bush (mm)
7341-0S	0.2-1.02mm	1 pc	6 pairs (the clamping range are 0.2-0.38, 0.38-0.51, 0.51-0.64, 0.64-0.76, 0.76-0.89, 0.89-1.02)
7341-1S	1.02-1.91mm	1 pc	7 pairs (the clamping range are 1.02-1.14, 1.14-1.27, 1.27-1.40, 1.40-1.52, 1.52-1.65, 1.65-1.78, 1.78-1.91)
7341-2S	1.91-3.33mm	1 pc	8 pairs (the clamping range are 1.91-2.08, 2.08-2.26, 2.26-2.44, 2.44-2.62, 2.62-2.79, 2.79-2.97, 2.97-3.15, 3.15-3.33)
7341-3S	3.33-4.57mm	1 pc	7 pairs (the clamping range are 3.33-3.51, 3.51-3.68, 3.68-3.86, 3.86-4.04, 4.04-4.22, 4.22-4.39, 4.39-4.57)
7341-4S	4.57-5.79mm	1 pc	6 pairs (the clamping range are 4.57-4.78, 4.78-4.98, 4.98-5.18, 5.18-5.38, 5.38-5.59, 5.59-5.79)
7341-5S	5.79-7.14mm	1 pc	6 pairs (the clamping range are 5.79-5.99, 5.99-6.20, 6.20-6.40, 6.40-6.63, 6.63-6.88, 6.88-7.14)

Code	Applicable pin gage diameter	Including	
		handle	clamping bush (mm)
7341-6S	7.14-8.66mm	1 pc	6 pairs (the clamping range are 7.14-7.39, 7.39-7.65, 7.65-7.90, 7.90-8.15, 8.15-8.41, 8.41-8.66)
7341-7S	8.66-10.31mm	1 pc	6 pairs (the clamping range are 8.66-8.92, 8.9 -9.17, 9.17-9.42, 9.42-9.70, 9.70-10.01, 10.01-10.31)
7341-8S	10.31-11.81mm	1 pc	4 pairs (the clamping range are 10.31-10.67, 10.67-11.05, 11.05-11.43, 11.43-11.81)
7341-9S	11.81-12.95mm	1 pc	3 pairs (the clamping range are 11.81-12.19, 12.19-12.57, 12.57-12.95)
7341-10S	12.95-14.71mm	1 pc	4 pairs (the clamping range are 12.95-13.51, 13.51-13.89, 13.89-14.30, 14.30-14.71)
7341-11S	14.71-16.13mm	1 pc	4 pairs (the clamping range are 14.71-15.09, 15.09-15.49, 15.49-15.88, 15.88-16.13)
7341-12S	16.13-17.88mm	1 pc	4 pairs (the clamping range are 16.13-16.66, 16.66-17.07, 17.07-17.48, 17.48-17.88)
7341-13S	17.88-19.30mm	1 pc	4 pairs (the clamping range are 17.88-18.26, 18.26-18.67, 18.67-19.05, 19.05-19.30)
7341-15S	19.30-24.80mm	1 pc	8 pairs (the clamping range are 19.30-19.84, 19.84-20.62, 20.62-21.41, 21.41-22.23, 22.23-23.03, 23.03-23.80, 23.80-24.59, 24.59-24.80)

SINGLE END PIN GAGE HANDLES (OPERATED WITH WRENCH)

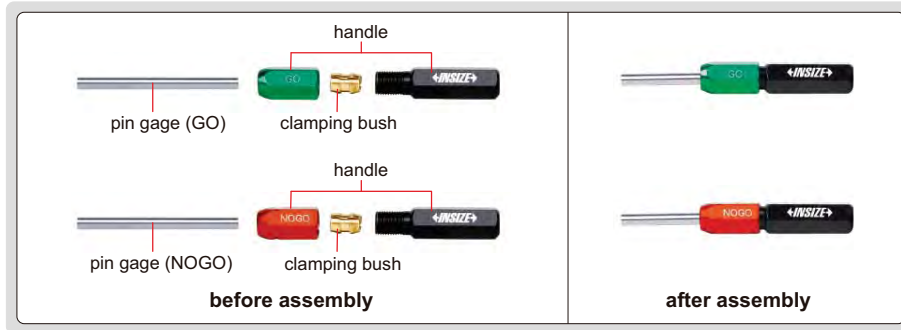

7344-4G
green (GO)



7344-4R
red (NOGO)



brass clamping bush
(0.2~7.14mm)



aluminum clamping bush
(7.14~24.80mm)

- Wrench is needed to install pins
- Clamping bushes (0.2~7.14mm) are made of brass, clamping bushes (7.14~24.80mm) are made of aluminum

Code		handle	Including clamping bush (mm)	Applicable pin gage diameter
green (GO)	red (NOGO)			
7344-0G	7344-0R	1 pc	6 pcs (the clamping range are 0.2-0.38, 0.38-0.51, 0.51-0.64, 0.64-0.76, 0.76-0.89, 0.89-1.02)	0.2-1.02mm
7344-1G	7344-1R	1 pc	7 pcs (the clamping range are 1.02-1.14, 1.14-1.27, 1.27-1.40, 1.40-1.52, 1.52-1.65, 1.65-1.78, 1.78-1.91)	1.02-1.91mm
7344-2G	7344-2R	1 pc	8 pcs (the clamping range are 1.91-2.08, 2.08-2.26, 2.26-2.44, 2.44-2.62, 2.62-2.79, 2.79-2.97, 2.97-3.15, 3.15-3.33)	1.91-3.33mm
7344-3G	7344-3R	1 pc	7 pcs (the clamping range are 3.33-3.51, 3.51-3.68, 3.68-3.86, 3.86-4.04, 4.04-4.22, 4.22-4.39, 4.39-4.57)	3.33-4.57mm
7344-4G	7344-4R	1 pc	6 pcs (the clamping range are 4.57-4.78, 4.78-4.98, 4.98-5.18, 5.18-5.38, 5.38-5.59, 5.59-5.79)	4.57-5.79mm
7344-5G	7344-5R	1 pc	6 pcs (the clamping range are 5.79-5.99, 5.99-6.20, 6.20-6.40, 6.40-6.63, 6.63-6.88, 6.88-7.14)	5.79-7.14mm
7344-6G	7344-6R	1 pc	6 pcs (the clamping range are 7.14-7.39, 7.39-7.65, 7.65-7.90, 7.90-8.15, 8.15-8.41, 8.41-8.66)	7.14-8.66mm
7344-7G	7344-7R	1 pc	6 pcs (the clamping range are 8.66-8.92, 8.92-9.17, 9.17-9.42, 9.42-9.70, 9.70-10.01, 10.01-10.31)	8.66-10.31mm
7344-8G	7344-8R	1 pc	4 pcs (the clamping range are 10.31-10.67, 10.67-11.05, 11.05-11.43, 11.43-11.81)	10.31-11.81mm
7344-9G	7344-9R	1 pc	3 pcs (the clamping range are 11.81-12.19, 12.19-12.57, 12.57-12.95)	11.81-12.95mm
7344-10G	7344-10R	1 pc	4 pcs (the clamping range are 12.95-13.51, 13.51-13.89, 13.89-14.30, 14.30-14.71)	12.95-14.71mm
7344-11G	7344-11R	1 pc	4 pcs (the clamping range are 14.71-15.09, 15.09-15.49, 15.49-15.88, 15.88-16.13)	14.71-16.13mm
7344-12G	7344-12R	1 pc	4 pcs (the clamping range are 16.13-16.66, 16.66-17.07, 17.07-17.48, 17.48-17.88)	16.13-17.88mm
7344-13G	7344-13R	1 pc	4 pcs (the clamping range are 17.88-18.26, 18.26-18.67, 18.67-19.05, 19.05-19.30)	17.88-19.30mm
7344-15G	7344-15R	1 pc	8 pcs (the clamping range are 19.30-19.84, 19.84-20.62, 20.62-21.41, 21.41-22.23, 22.23-23.03, 23.03-23.80, 23.80-24.59, 24.59-24.80)	19.30-24.80mm

CYLINDER GAGES

CAN SUPPLY CUSTOM SIZES FROM Ø3.000mm TO Ø200.000mm, FOR EXAMPLE, Ø20.218mm



- Made of tungsten steel, quenched, ultra-low temperature treatment
- Wear resistant, long life, dimension stability
- Hardness HRC60-62



6316-30

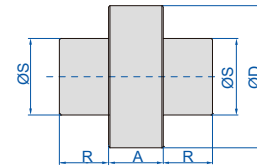
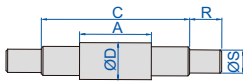

13

Diameter ØD *	A	C	R	ØS	Deviation **	Roundness and cylindricity
3.0-3.81	9.52	17.46	11.1	2.4	±5µm	0.5µm
3.81-5.84	11.11	19.05	11.1	3.2	±5µm	0.5µm
5.84-9.27	12.7	20.64	11.1	5.6	±5µm	0.5µm

(mm)

Diameter ØD *	A	ØS	R	Deviation **	Roundness and cylindricity
38.35-51.05	31.8	22.2	15.8	±5µm	1µm
51.05-63.75	31.8	22.2	15.8	±5µm	1µm
63.75-76.45	38.1	25.4	39.8	±5µm	1.2µm
76.45-89.15	38.1	25.4	39.8	±5µm	1.2µm
89.15-101.85	38.1	25.4	39.8	±5µm	1.2µm
101.85-114.55	38.1	25.4	39.8	±5µm	1.2µm
114.55-127.25	38.1	25.4	39.8	±5µm	1.6µm
127.25-139.95	38.1	25.4	39.8	±5µm	1.6µm
139.95-152.62	38.1	25.4	39.8	±5µm	1.6µm
152.65-165.35	38.1	25.4	39.8	±5µm	1.6µm
165.35-178.05	38.1	25.4	39.8	±5µm	2µm
178.05-190.75	38.1	25.4	39.8	±5µm	2µm
190.75-203.45	38.1	25.4	39.8	±5µm	2µm

(mm)

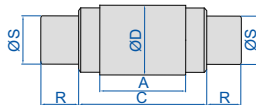

Diameter ØD *	A	C	R	ØS	Deviation **	Roundness and cylindricity
9.27-12.95	14.29	22.22	12.7	8.7	±5µm	0.5µm
12.95-20.96	15.88	23.81	12.7	12.7	±5µm	0.5µm
20.96-28.83	17.46	25.4	15.9	19	±5µm	0.7µm
28.83-38.35	20.64	28.58	15.9	25.4	±5µm	0.7µm

(mm)

* For example, 3-3.81 indicates 3mm<D≤3.8mm

** Deviation (difference between the ordered size and the size marked on the cylinder gages when supplied).
For example, the ordered size is Ø3.000mm, the size marked on the cylinder gages when supplied may be Ø3.003mm

Code	ØD	Code	ØD	Code	ØD	Code	ØD	Code	ØD
6316-3 *	Ø3mm	6316-16 *	Ø16mm	6316-29 *	Ø29mm	6316-42 *	Ø42mm	6316-70 *	Ø70mm
6316-4 *	Ø4mm	6316-17 *	Ø17mm	6316-30 *	Ø30mm	6316-43 *	Ø43mm	6316-75 *	Ø75mm
6316-5 *	Ø5mm	6316-18 *	Ø18mm	6316-31 *	Ø31mm	6316-44 *	Ø44mm	6316-80 *	Ø80mm
6316-6 *	Ø6mm	6316-19 *	Ø19mm	6316-32 *	Ø32mm	6316-45 *	Ø45mm	6316-85 *	Ø85mm
6316-7 *	Ø7mm	6316-20 *	Ø20mm	6316-33 *	Ø33mm	6316-46 *	Ø46mm	6316-87 *	Ø87mm
6316-8 *	Ø8mm	6316-21 *	Ø21mm	6316-34 *	Ø34mm	6316-47 *	Ø47mm	6316-90 *	Ø90mm
6316-9 *	Ø9mm	6316-22 *	Ø22mm	6316-35 *	Ø35mm	6316-48 *	Ø48mm	6316-95 *	Ø95mm
6316-10 *	Ø10mm	6316-23 *	Ø23mm	6316-36 *	Ø36mm	6316-49 *	Ø49mm	6316-100 *	Ø100mm
6316-11 *	Ø11mm	6316-24 *	Ø24mm	6316-37 *	Ø37mm	6316-50 *	Ø50mm	6316-125 *	Ø125mm
6316-12 *	Ø12mm	6316-25 *	Ø25mm	6316-38 *	Ø38mm	6316-55 *	Ø55mm	6316-150 *	Ø150mm
6316-13 *	Ø13mm	6316-26 *	Ø26mm	6316-39 *	Ø39mm	6316-60 *	Ø60mm	6316-175 *	Ø175mm
6316-14 *	Ø14mm	6316-27 *	Ø27mm	6316-40 *	Ø40mm	6316-62 *	Ø62mm	6316-200 *	Ø200mm
6316-15 *	Ø15mm	6316-28 *	Ø28mm	6316-41 *	Ø41mm	6316-65 *	Ø65mm		

* Supplied with manufacturer inspection certificate

**FAST AND ACCURATE
MEASUREMENT OF CYLINDERS**

ADJUSTABLE SNAP GAGES

- Used as Go/No-Go gage by setting upper and lower limits
- Flatness of anvil: 1.5µm
- Parallelism of measuring faces:
range 0-32mm: 3µm
range 32-89mm: 4µm
range 89-300mm: 5µm

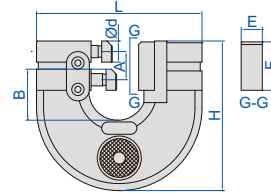

2187-19

(mm)

Code	Range	L	A	B	E	F	H	Ød
2187-6	0-6mm	74	15	17.5	12.2	27.2	71.5	7
2187-13	6-13mm	85	15	26	12.2	27.2	79.5	12.3
2187-19	13-19mm	93	15	27	12.2	27.2	83	12.3
2187-25	19-25mm	100	15	33.5	12.2	27.2	89.5	12.3
2187-32	25-32mm	111	18	38.5	15.2	35.2	104	15.3
2187-38	32-38mm	117	18	41.5	15.2	35.2	105	15.3
2187-44	38-44mm	123	18	44.5	15.2	35.2	109	15.3
2187-51	44-51mm	130	18	48	15.2	35.2	117	15.3
2187-57	51-57mm	136	18	45	15.2	35.2	119	15.3
2187-63	57-63mm	143	18	50	15.2	35.2	122	15.3
2187-70	63-70mm	156	20	58	15.2	35.2	132	15.3
2187-76	70-76mm	163	20	60.5	15.2	35.2	137	15.3
2187-82	76-82mm	169	20	64.5	15.2	35.2	140	15.3
2187-89	82-89mm	175	20	66.5	15.2	35.2	146	15.3
2187-95	89-95mm	181	20	69.5	15.2	35.2	149	15.3
2187-101	95-101mm	188	20	70	15.2	35.2	154	15.3
2187-108	101-108mm	198	24	79	15.2	39.2	166	15.3
2187-114	108-114mm	204	24	81	15.2	39.2	172	15.3
2187-120	114-120mm	210	24	86	15.2	39.2	179	15.3
2187-127	120-127mm	217	24	89.5	15.2	39.2	186	15.3
2187-133	127-133mm	223	24	92.5	15.2	39.2	192	15.3
2187-139	133-139mm	229	24	95.5	15.2	39.2	197	15.3
2187-146	139-146mm	235	24	98.5	15.2	39.2	201	15.3
2187-152	146-152mm	242	24	102	15.2	39.2	205	15.3
2187-163	152-163mm	273	21.4	106.7	18.2	39.2	211	18.3
2187-175	163-175mm	273	21.4	106.7	18.2	39.2	211	18.3
2187-188	175-188mm	298.5	21.4	119.7	18.2	39.2	227	18.3
2187-200	188-200mm	298.5	21.4	119.7	18.2	39.2	227	18.3
2187-213	200-213mm	324	21.4	131.7	18.2	39.2	242	18.3
2187-225	213-225mm	324	21.4	131.7	18.2	39.2	242	18.3
2187-238	225-238mm	349.5	21.4	144.7	18.2	39.2	250	18.3
2187-250	238-250mm	349.5	21.4	149	18.2	39.2	250	18.3
2187-263	250-263mm	375.5	21.4	157.7	18.2	39.2	278	18.3
2187-275	263-275mm	375.5	21.4	157.7	18.2	39.2	278	18.3
2187-288	275-288mm	400	21.4	170.7	18.2	39.2	291	18.3
2187-300	288-300mm	400	21.4	170.7	18.2	39.2	291	18.3

SETTING RINGS



CAN SUPPLY CUSTOM SETTING RINGS FROM Ø1.500MM TO Ø400.000MM, FOR EXAMPLE, Ø17.085MM

- For zero setting of inside micrometers, three points internal micrometers and bore gages
- The size marked on the setting ring is checked at the direction of the marking line
- Deviation (difference between the ordered size and the size marked on the setting ring when supplied): For example, the ordered size is Ø10.125mm, the size marked on the setting ring when supplied may be Ø10.135mm
- Meet DIN2250-1:2008

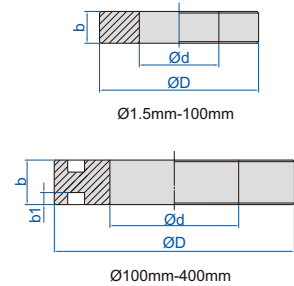

13

Diameter d**	b	ØD	Deviation	Roundness and cylindricity
Ø1.5-2.5	4	22	±10.0µm	0.3µm
Ø2.5-3	5	22	±10.0µm	0.3µm
Ø3-5	5	22	±10.0µm	0.4µm
Ø5-10	8	32	±10.0µm	0.4µm
Ø10-15	10	38	±10.0µm	0.5µm
Ø15-18	12	45	±10.0µm	0.5µm
Ø18-20	12	45	±10.0µm	0.6µm
Ø20-25	14	53	±10.0µm	0.6µm
Ø25-30	16	63	±10.0µm	0.6µm
Ø30-32	16	63	±10.0µm	0.7µm
Ø32-40	18	71	±10.0µm	0.7µm
Ø40-50	20	85	±10.0µm	0.7µm
Ø50-60	20	100	±10.0µm	0.8µm
Ø60-70	24	112	±10.0µm	0.8µm
Ø70-80	24	125	±10.0µm	0.8µm
Ø80-90	24	140	±10.0µm	1.0µm
Ø90-100	24	160	±10.0µm	1.0µm

** For example Ø3-5mm means Ø3mm < diameter d ≤ 5mm

Diameter d**	b	b1	ØD	Deviation	Roundness and cylindricity
Ø100-110	30	8	164	±10.0µm	1.0µm
Ø110-130	34	10	192	±10.0µm	1.0µm
Ø130-150	34	10	220	±10.0µm	1.2µm
Ø150-170	36	10	248	±10.0µm	1.5µm
Ø170-190	36	10	276	±10.0µm	1.5µm
Ø190-210	38	10	300	±10.0µm	1.5µm
Ø210-230	38	10	324	±10.0µm	2.5µm
Ø230-250	40	12	350	±10.0µm	2.5µm
Ø250-270	40	12	375	±10.0µm	3.0µm
Ø270-290	42	12	400	±10.0µm	3.0µm
Ø290-300	42	12	425	±10.0µm	3.0µm
Ø300-320	42	12	430	±10.0µm	4.0µm
Ø320-330	42	12	440	±10.0µm	4.0µm
Ø330-340	42	12	450	±10.0µm	4.0µm
Ø340-350	42	12	460	±10.0µm	4.0µm
Ø350-360	42	12	470	±10.0µm	4.0µm
Ø360-370	42	12	480	±10.0µm	4.0µm
Ø370-380	42	12	490	±10.0µm	4.0µm
Ø380-390	42	12	500	±10.0µm	4.0µm
Ø390-400	42	12	510	±10.0µm	4.0µm

(mm)		(mm)		(mm)		(mm)		(mm)	
Code	Size	Code	Size	Code	Size	Code	Size	Code	Size
6312-1D5 *	Ø1.5	6312-12D5 *	Ø12.5	6312-23D5 *	Ø23.5	6312-39 *	Ø39	6312-95 *	Ø95
6312-2 *	Ø2	6312-13 *	Ø13	6312-24 *	Ø24	6312-40 *	Ø40	6312-100 *	Ø100
6312-2D5 *	Ø2.5	6312-13D5 *	Ø13.5	6312-24D5 *	Ø24.5	6312-41 *	Ø41	6312-112D5 *	Ø112.5
6312-3 *	Ø3	6312-14 *	Ø14	6312-25 *	Ø25	6312-42 *	Ø42	6312-125 *	Ø125
6312-3D5 *	Ø3.5	6312-14D5 *	Ø14.5	6312-25D5 *	Ø25.5	6312-43 *	Ø43	6312-137D5 *	Ø137.5
6312-4 *	Ø4	6312-15 *	Ø15	6312-26 *	Ø26	6312-44 *	Ø44	6312-150 *	Ø150
6312-4D5 *	Ø4.5	6312-15D5 *	Ø15.5	6312-26D5 *	Ø26.5	6312-45 *	Ø45	6312-162D5 *	Ø162.5
6312-5 *	Ø5	6312-16 *	Ø16	6312-27 *	Ø27	6312-46 *	Ø46	6312-175 *	Ø175
6312-5D5 *	Ø5.5	6312-16D5 *	Ø16.5	6312-27D5 *	Ø27.5	6312-47 *	Ø47	6312-187D5 *	Ø187.5
6312-6 *	Ø6	6312-17 *	Ø17	6312-28 *	Ø28	6312-48 *	Ø48	6312-200 *	Ø200
6312-6D5 *	Ø6.5	6312-17D5 *	Ø17.5	6312-28D5 *	Ø28.5	6312-49 *	Ø49	6312-212D5 *	Ø212.5
6312-7 *	Ø7	6312-18 *	Ø18	6312-29 *	Ø29	6312-50 *	Ø50	6312-225 *	Ø225
6312-7D5 *	Ø7.5	6312-18D5 *	Ø18.5	6312-29D5 *	Ø29.5	6312-55 *	Ø55	6312-237D5 *	Ø237.5
6312-8 *	Ø8	6312-19 *	Ø19	6312-30 *	Ø30	6312-60 *	Ø60	6312-250 *	Ø250
6312-8D5 *	Ø8.5	6312-19D5 *	Ø19.5	6312-31 *	Ø31	6312-62 *	Ø62	6312-262D5 *	Ø262.5
6312-9 *	Ø9	6312-20 *	Ø20	6312-32 *	Ø32	6312-65 *	Ø65	6312-275 *	Ø275
6312-9D5 *	Ø9.5	6312-20D5 *	Ø20.5	6312-33 *	Ø33	6312-70 *	Ø70	6312-287D5 *	Ø287.5
6312-10 *	Ø10	6312-21 *	Ø21	6312-34 *	Ø34	6312-75 *	Ø75	6312-300 *	Ø300
6312-10D5 *	Ø10.5	6312-21D5 *	Ø21.5	6312-35 *	Ø35	6312-80 *	Ø80	6312-350 *	Ø350
6312-11 *	Ø11	6312-22 *	Ø22	6312-36 *	Ø36	6312-85 *	Ø85	6312-400 *	Ø400
6312-11D5 *	Ø11.5	6312-22D5 *	Ø22.5	6312-37 *	Ø37	6312-87 *	Ø87		
6312-12 *	Ø12	6312-23 *	Ø23	6312-38 *	Ø38	6312-90 *	Ø90		

* Supplied with manufacturer inspection certificate

CUSTOM-MADE

OTHER CLASSES ARE AVAILABLE, SUCH AS H8, H9
 OTHER DIAMETERS ARE AVAILABLE, SUCH AS 19.003mm
 OTHER LENGTHS ARE AVAILABLE, SUCH AS 70mm

PLAIN PLUG GAGES



4124-12

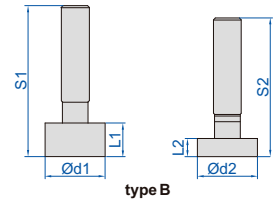
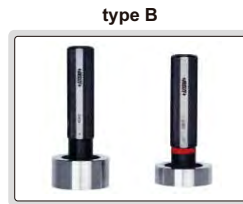
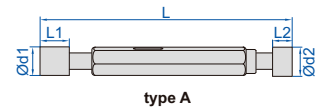
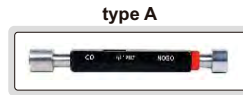

- Supplied with Go and No-Go gages together
- Class H7
- Hardness HRC 60±2
- Standard DIN7150-2

Size tolerance of H7

(mm)

Diameter $\varnothing d$	Type	Size tolerance of Go gage (μm)	Size tolerance of No-Go gage (μm)	L1	L2	L	S1, S2
$\geq 2, \leq 3$	A	+0.5 / +2.5	+9 / +11	6.5	4.5	62	–
$> 3, \leq 6$	A	+0.75 / +3.25	+10.75 / +13.25	8	6	74	–
$> 6, \leq 10$	A	+0.75 / +3.25	+13.75 / +16.25	10	7	87	–
$> 10, \leq 14$	A	+1 / +4	+16.5 / +19.5	12	8	99	–
$> 14, \leq 18$	A	+1 / +4	+16.5 / +19.5	14	10	114	–
$> 18, \leq 24$	A	+1 / +5	+19 / +23	16	12	132	–
$> 24, \leq 30$	A	+1 / +5	+19 / +23	18	14	136	–
$> 30, \leq 40$	A	+1.5 / +5.5	+23 / +27	20	15	155	–
$> 40, \leq 50$	A	+1.5 / +5.5	+23 / +27	25	18	169	–
$> 50, \leq 65$	B	+1.5 / +6.5	+27.5 / +32.5	30	18	–	164, 152
$> 65, \leq 80$	B	+1.5 / +6.5	+27.5 / +32.5	35	25	–	169, 159
$> 80, \leq 100$	B	+2 / +8	+32 / +38	35	25	–	169, 159

Code	Diameter	Type	Code	Diameter	Type	Code	Diameter	Type	Code	Diameter	Type
4124-2	2mm	A	4124-17	17mm	A	4124-32	32mm	A	4124-47	47mm	A
4124-3	3mm	A	4124-18	18mm	A	4124-33	33mm	A	4124-48	48mm	A
4124-4	4mm	A	4124-19	19mm	A	4124-34	34mm	A	4124-49	49mm	A
4124-5	5mm	A	4124-20	20mm	A	4124-35	35mm	A	4124-50	50mm	A
4124-6	6mm	A	4124-21	21mm	A	4124-36	36mm	A	4124-52	52mm	B
4124-7	7mm	A	4124-22	22mm	A	4124-37	37mm	A	4124-55	55mm	B
4124-8	8mm	A	4124-23	23mm	A	4124-38	38mm	A	4124-60	60mm	B
4124-9	9mm	A	4124-24	24mm	A	4124-39	39mm	A	4124-65	65mm	B
4124-10	10mm	A	4124-25	25mm	A	4124-40	40mm	A	4124-70	70mm	B
4124-11	11mm	A	4124-26	26mm	A	4124-41	41mm	A	4124-75	75mm	B
4124-12	12mm	A	4124-27	27mm	A	4124-42	42mm	A	4124-80	80mm	B
4124-13	13mm	A	4124-28	28mm	A	4124-43	43mm	A	4124-85	85mm	B
4124-14	14mm	A	4124-29	29mm	A	4124-44	44mm	A	4124-90	90mm	B
4124-15	15mm	A	4124-30	30mm	A	4124-45	45mm	A	4124-95	95mm	B
4124-16	16mm	A	4124-31	31mm	A	4124-46	46mm	A	4124-100	100mm	B

CERAMIC MEASURING BALLS



4190-40D000

- Zirconia material, high strength and hardness, extremely wear resistance and corrosion resistance, good insulation, antistatic and magnetic resistance
- Mirror surface without holes
- Supplied with manufacturer inspection certificate

13

Individual

Code	Diameter	Accuracy	Roundness
4190-1D000	1.000mm	±2µm	0.5µm
4190-1D200	1.200mm	±2µm	0.5µm
4190-1D300	1.300mm	±2µm	0.5µm
4190-1D340	1.340mm	±2µm	0.5µm
4190-1D500	1.500mm	±2µm	0.5µm
4190-1D588	1.588mm (1/16")	±2µm	0.5µm
4190-1D750	1.750mm	±2µm	0.5µm
4190-2D000	2.000mm	±2µm	0.5µm
4190-2D381	2.381mm (3/32")	±2µm	0.5µm
4190-2D500	2.500mm	±2µm	0.5µm
4190-2D778	2.778mm (7/64")	±2µm	0.5µm
4190-3D000	3.000mm	±2µm	0.5µm
4190-3D175	3.175mm (1/8")	±2µm	0.5µm
4190-3D500	3.500mm	±2µm	0.5µm
4190-3D969	3.969mm (5/32")	±2µm	0.5µm
4190-4D000	4.000mm	±2µm	0.5µm
4190-4D500	4.500mm	±2µm	0.5µm
4190-4D763	4.763mm (3/16")	±2µm	0.5µm
4190-5D000	5.000mm	±2µm	0.5µm
4190-5D556	5.556mm (7/32")	±2µm	0.5µm
4190-5D953	5.953mm (15/64")	±2µm	0.5µm
4190-6D000	6.000mm	±2µm	0.5µm
4190-6D350	6.350mm (1/4")	±2µm	0.5µm
4190-6D500	6.500mm	±2µm	0.5µm
4190-6D747	6.747mm (17/64")	±2µm	0.5µm
4190-7D000	7.000mm	±2µm	0.5µm
4190-7D144	7.144mm (9/32")	±2µm	0.5µm
4190-7D500	7.500mm	±2µm	0.5µm
4190-7D938	7.938mm (5/16")	±2µm	0.5µm
4190-8D000	8.000mm	±2µm	0.5µm
4190-8D731	8.731mm (11/32")	±2µm	0.5µm

Individual

Code	Diameter	Accuracy	Roundness
4190-9D525	9.525mm (3/8")	±2µm	0.5µm
4190-10D000	10.000mm	±2µm	0.5µm
4190-10D318	10.318mm (13/32")	±2µm	0.5µm
4190-11D000	11.000mm	±2µm	0.5µm
4190-11D113	11.113mm (7/16")	±2µm	0.5µm
4190-11D509	11.509mm (29/64")	±2µm	0.5µm
4190-11D906	11.906mm (15/32")	±2µm	0.5µm
4190-12D000	12.000mm	±2µm	0.5µm
4190-12D303	12.303mm (31/64")	±2µm	0.5µm
4190-12D700	12.700mm (1/2")	±2µm	0.5µm
4190-13D000	13.000mm	±2µm	0.6µm
4190-13D494	13.494mm (17/32")	±2µm	0.6µm
4190-14D000	14.000mm	±2µm	0.6µm
4190-14D288	14.288mm (9/16")	±2µm	0.6µm
4190-15D000	15.000mm	±2µm	0.6µm
4190-15D081	15.081mm (19/32")	±2.5µm	0.6µm
4190-15D875	15.875mm (5/8")	±2.5µm	0.6µm
4190-16D000	16.000mm	±2.5µm	0.6µm
4190-16D669	16.669mm (21/32")	±2.5µm	0.6µm
4190-17D462	17.462mm (11/16")	±2.5µm	0.6µm
4190-18D000	18.000mm	±2.5µm	0.6µm
4190-18D256	18.256mm (23/32")	±2.5µm	0.6µm
4190-19D050	19.050mm (3/4")	±2.5µm	0.6µm
4190-19D844	19.844mm (25/32")	±2.5µm	0.6µm
4190-20D000	20.000mm	±2.5µm	0.6µm
4190-22D000	22.000mm	±2.5µm	1µm
4190-22D225	22.225mm (7/8")	±2.5µm	1µm
4190-23D812	23.812mm (15/16")	±2.5µm	1µm
4190-25D000	25.000mm	±2.5µm	1µm
4190-40D000	40.000mm	±2.5µm	1.5µm

Set (25 pairs)

Code	Ceramic balls included (one pair per size)
4190-S25	1, 1.5, 2, 2.5, 3, 3.5, 4, 4.5, 5, 6, 6.5, 7, 7.5, 8, 10, 11, 12, 13, 14, 15, 16, 18, 20, 22, 25mm

STEEL MEASURING BALLS



- To measure angle and diameter of taper holes
- Material: tool steel
- Hardness: HRC63
- Diameter accuracy: $\pm 3\mu\text{m}$
- Roundness: $1\mu\text{m}$
- Supplied with manufacturer inspection certificate



4168-S25

calculate angle (α) and diameter (D_{max}) according to the ball diameter (d_1 , d_2), height (A) and depth (B)

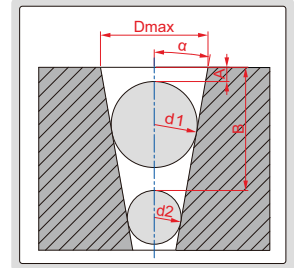

Individual

Code	Diameter
4168-01	1mm
4168-02	2mm
4168-03	3mm
4168-04	4mm
4168-05	5mm
4168-06	6mm
4168-07	7mm
4168-08	8mm
4168-09	9mm
4168-10	10mm
4168-11	11mm
4168-12	12mm
4168-13	13mm

Individual

Code	Diameter
4168-14	14mm
4168-15	15mm
4168-16	16mm
4168-17	17mm
4168-18	18mm
4168-19	19mm
4168-20	20mm
4168-21	21mm
4168-22	22mm
4168-23	23mm
4168-24	24mm
4168-25	25mm

Set (25 pairs)

Code	Steel balls included (one pair per size)
4168-S25	1, 2, 3, 4, 5, 6, 7, 8, 9, 10, 11, 12, 13, 14, 15, 16, 17, 18, 19, 20, 21, 22, 23, 24, 25mm

13

ANY SIZE WITHIN THE RANGE OF M3-M150MM CAN BE CUSTOMIZED

ACCURACY CLASS CAN BE CUSTOMIZED

THREADED HOLE LOCATION GAGES

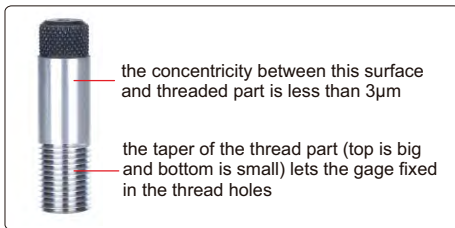

Code	Size	L	L1	L2	ØD
4662-3	M3×0.5-6H	29	8	6	3
4662-4	M4×0.7-6H	31.4	8	8.4	4
4662-5	M5×0.8-6H	32.6	8	9.6	5
4662-6	M6×1-6H	47	10	12	6
4662-8	M8×1.25-6H	50	10	15	8
4662-8P	M8×1-6H	47	10	12	8
4662-10	M10×1.5-6H	53	10	18	10
4662-10P	M10×1-6H	47	10	12	10
4662-12	M12×1.75-6H	56	10	21	12
4662-12P	M12×1-6H	47	10	12	12
4662-12R	M12×1.5-6H	53	10	18	12
4662-14	M14×2-6H	59	10	24	14
4662-14P	M14×1-6H	47	10	12	14
4662-14R	M14×1.5-6H	53	10	18	14
4662-16	M16×2-6H	59	10	24	16
4662-16P	M16×1-6H	47	10	12	16
4662-16R	M16×1.5-6H	53	10	18	16
4662-20	M20×2.5-6H	65	10	30	20
4662-20P	M20×1-6H	47	10	12	20
4662-20R	M20×1.5-6H	53	10	18	20



4662-12R



4662-3

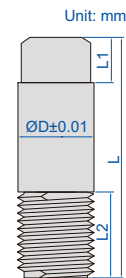

- Hardness: HRC60-63

application

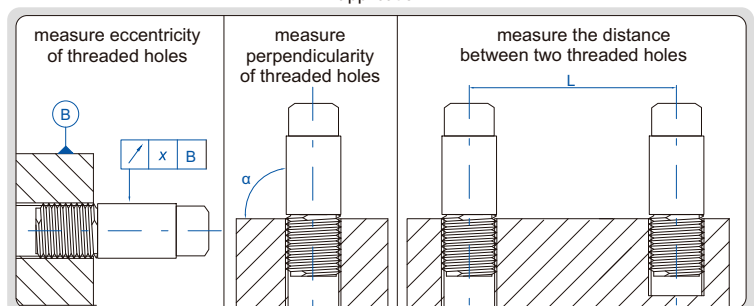

THREADED HOLE LOCATION GAGES

INSIZE PLUS
MADE IN EUROPE

ATTENTION: ONLY FOR THE WORKPIECES THAT THE CHAMFER IS CONCENTRIC WITH THE SCREW PART

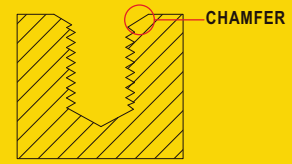

4676-12

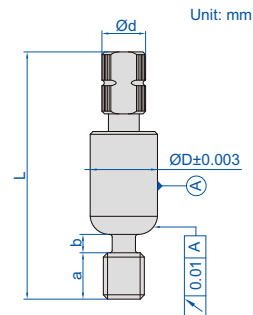

13

- Only for the workpieces that the chamfer is concentric with the screw part

application

there is a R-shaped guide, which leads the gage to the center of the threaded holes by fitting the R-shaped guide on the chamfer of the threaded holes

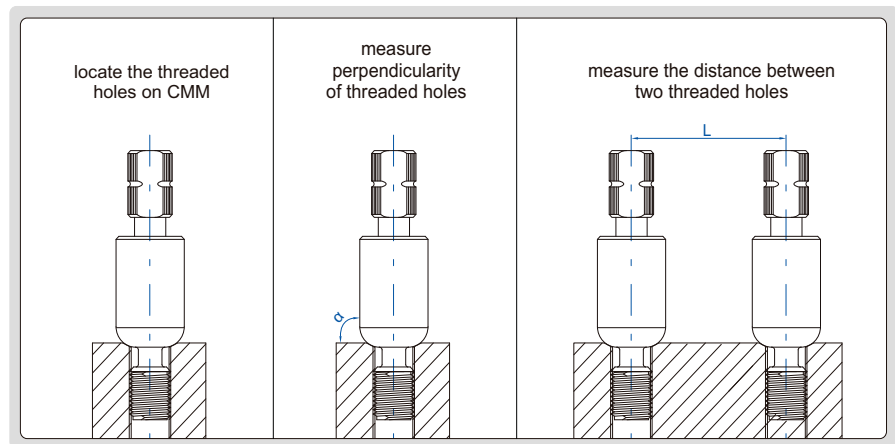
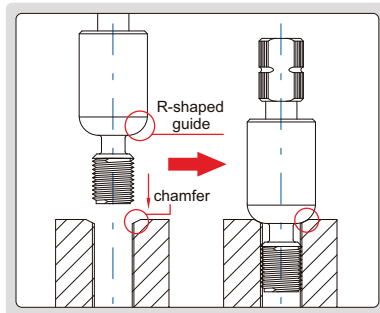

(mm)

Code	Size	Ød	ØD	a	b	L
4676-3	M3×0.5	4	7	4	2	26
4676-4	M4×0.7	4	7	4	2	26
4676-5	M5×0.8	5.5	9	6	2	33
4676-6	M6×1.0	5.5	9	6	2	33
4676-8	M8×1.25	8.5	13	9	3.5	48
4676-10	M10×1.5	8.5	13	9	3.5	48
4676-12	M12×1.75	12	17	10	3.5	55



DIGITAL THREAD DEPTH GAGES



4649-6

- Supplied with GO and NO-GO gages together
- Check GO and NO-GO while measuring the depth of thread holes
- Resolution: 0.01mm/0.0005"
- Depth 0-40mm: accuracy ± 0.04 mm;
Depth 40-80mm: accuracy ± 0.06 mm
- Data output
- Button function: on/of, inch/metric conversion, reading hold, data preset, absolute/incremental measurement
- Battery CR2032, automatic power off, move the digital unit to turn on power
- The GO gage can be replaced after wear
- Optional accessory: data output cable (code **7302-85**), zero block (code **4668-SETTER**), removal tool (code **4668-TOOL**)

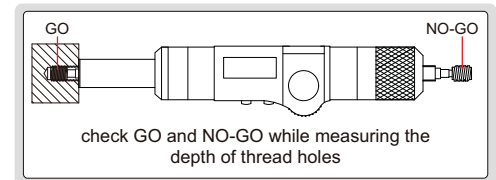
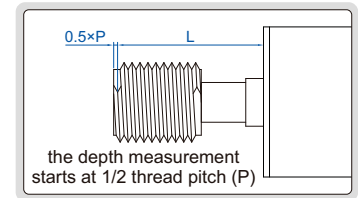

13

Metric thread

Code	Size	Depth range
4649-2 *	M2x0.4-6H	0-8mm
4649-2D5 *	M2.5x0.45-6H	0-10mm
4649-3 *	M3x0.5-6H	0-12mm
4649-3D5 *	M3.5x0.6-6H	0-14mm
4649-4 *	M4x0.7-6H	0-16mm
4649-5 *	M5x0.8-6H	0-20mm
4649-6 *	M6x1-6H	0-24mm
4649-7 *	M7x1-6H	0-28mm
4649-8 *	M8x1.25-6H	0-32mm
4649-10 *	M10x1.5-6H	0-40mm
4649-12 *	M12x1.75-6H	0-48mm
4649-14 *	M14x2-6H	0-56mm
4649-16 *	M16x2-6H	0-64mm
4649-18 *	M18x2.5-6H	0-72mm
4649-20 *	M20x2.5-6H	0-80mm
4649-22 *	M22x2.5-6H	0-80mm
4649-24 *	M24x3-6H	0-80mm
4649-27 *	M27x3-6H	0-80mm
4649-30 *	M30x3.5-6H	0-80mm

Metric fine thread

Code	Size	Depth range
4649-8P *	M8x1-6H	0-32mm
4649-10P *	M10x1-6H	0-40mm
4649-10T *	M10x1.25-6H	0-40mm
4649-12P *	M12x1-6H	0-48mm
4649-12T *	M12x1.25-6H	0-48mm
4649-12R *	M12x1.5-6H	0-48mm
4649-14P *	M14x1-6H	0-56mm
4649-14T *	M14x1.25-6H	0-56mm
4649-14R *	M14x1.5-6H	0-56mm
4649-16P *	M16x1-6H	0-64mm
4649-16R *	M16x1.5-6H	0-64mm
4649-18P *	M18x1-6H	0-72mm
4649-18R *	M18x1.5-6H	0-72mm
4649-20P *	M20x1-6H	0-80mm
4649-20R *	M20x1.5-6H	0-80mm
4649-22P *	M22x1-6H	0-80mm
4649-22R *	M22x1.5-6H	0-80mm
4649-24P *	M24x1-6H	0-80mm
4649-24R *	M24x1.5-6H	0-80mm

* Supplied with manufacturer inspection certificate

THREAD DEPTH GAGES

INSIZE PLUS
MADE IN EUROPE

**INSPECTION
CERTIFICATE**



4666-6



4666-14PA

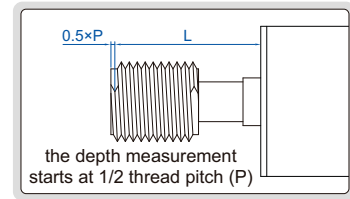

- Supplied with GO and NO-GO gages together
- Check GO and NO-GO while measuring the depth thread holes
- The GO gage can be replaced after wear
- Optional accessory: zero block (code **4668-SETTER**), removal tool (code **4668-TOOL**)

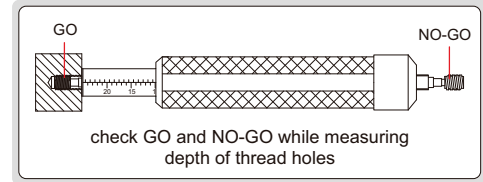

Metric thread (without vernier reading, graduation: 0.5mm, accuracy: ±0.25mm)

Code	Size	Depth range
4666-2*	M2x0.4-6H	0-8mm
4666-2D5*	M2.5x0.45-6H	0-10mm
4666-3*	M3x0.5-6H	0-12mm
4666-3D5*	M3.5x0.6-6H	0-14mm
4666-4*	M4x0.7-6H	0-16mm
4666-5*	M5x0.8-6H	0-20mm
4666-6*	M6x1-6H	0-24mm
4666-7*	M7x1-6H	0-28mm
4666-8*	M8x1.25-6H	0-32mm
4666-10*	M10x1.5-6H	0-40mm
4666-12*	M12x1.75-6H	0-48mm
4666-14*	M14x2-6H	0-56mm
4666-16*	M16x2-6H	0-64mm
4666-18*	M18x2.5-6H	0-72mm
4666-20*	M20x2.5-6H	0-80mm
4666-22*	M22x2.5-6H	0-80mm
4666-24*	M24x3-6H	0-80mm
4666-27*	M27x3-6H	0-80mm
4666-30*	M30x3.5-6H	0-80mm

Metric thread (with vernier reading, graduation: 0.1mm, accuracy: ±0.1mm)

Code	Size	Depth range
4666-2A*	M2x0.4-6H	0-8mm
4666-2D5A*	M2.5x0.45-6H	0-10mm
4666-3A*	M3x0.5-6H	0-12mm
4666-3D5A*	M3.5x0.6-6H	0-14mm
4666-4A*	M4x0.7-6H	0-16mm
4666-5A*	M5x0.8-6H	0-20mm
4666-6A*	M6x1-6H	0-24mm
4666-7A*	M7x1-6H	0-28mm
4666-8A*	M8x1.25-6H	0-32mm
4666-10A*	M10x1.5-6H	0-40mm
4666-12A*	M12x1.75-6H	0-48mm
4666-14A*	M14x2-6H	0-56mm
4666-16A*	M16x2-6H	0-64mm
4666-18A*	M18x2.5-6H	0-72mm
4666-20A*	M20x2.5-6H	0-80mm
4666-22A*	M22x2.5-6H	0-80mm
4666-24A*	M24x3-6H	0-80mm
4666-27A*	M27x3-6H	0-80mm
4666-30A*	M30x3.5-6H	0-80mm



Metric fine thread (without vernier reading, graduation: 0.5mm, accuracy: ±0.25mm)

Code	Size	Depth range
4666-8P*	M8x1-6H	0-32mm
4666-10P*	M10x1-6H	0-40mm
4666-10T*	M10x1.25-6H	0-40mm
4666-12P*	M12x1-6H	0-48mm
4666-12T*	M12x1.25-6H	0-48mm
4666-12R*	M12x1.5-6H	0-48mm
4666-14P*	M14x1-6H	0-56mm
4666-14T*	M14x1.25-6H	0-56mm
4666-14R*	M14x1.5-6H	0-56mm
4666-16P*	M16x1-6H	0-64mm
4666-16R*	M16x1.5-6H	0-64mm
4666-18P*	M18x1-6H	0-72mm
4666-18R*	M18x1.5-6H	0-72mm
4666-20P*	M20x1-6H	0-80mm
4666-20R*	M20x1.5-6H	0-80mm
4666-22P*	M22x1-6H	0-80mm
4666-22R*	M22x1.5-6H	0-80mm
4666-24P*	M24x1-6H	0-80mm
4666-24R*	M24x1.5-6H	0-80mm

Metric fine thread (with vernier reading, graduation: 0.1mm, accuracy: ±0.1mm)

Code	Size	Depth range
4666-8PA*	M8x1-6H	0-32mm
4666-10PA*	M10x1-6H	0-40mm
4666-10TA*	M10x1.25-6H	0-40mm
4666-12PA*	M12x1-6H	0-48mm
4666-12TA*	M12x1.25-6H	0-48mm
4666-12RA*	M12x1.5-6H	0-48mm
4666-14PA*	M14x1-6H	0-56mm
4666-14TA*	M14x1.25-6H	0-56mm
4666-14RA*	M14x1.5-6H	0-56mm
4666-16PA*	M16x1-6H	0-64mm
4666-16RA*	M16x1.5-6H	0-64mm
4666-18PA*	M18x1-6H	0-72mm
4666-18RA*	M18x1.5-6H	0-72mm
4666-20PA*	M20x1-6H	0-80mm
4666-20RA*	M20x1.5-6H	0-80mm
4666-22PA*	M22x1-6H	0-80mm
4666-22RA*	M22x1.5-6H	0-80mm
4666-24PA*	M24x1-6H	0-80mm
4666-24RA*	M24x1.5-6H	0-80mm

* Supplied with manufacturer inspection certificate



DLC COATED THREAD RING GAGES AND PLUG GAGES



- The DLC coating has the following advantages:
 - High hardness, extremely wear resistance
 - Low friction coefficient
 - Corrosion resistance
- Plug gages: GO is coated, NO-GO is not;
Ring gages: GO is coated, NO-GO is not
- The following thread ring gages and plug gages are available with DLC coating:
 - Metric fine thread ring gages and plug gages (4139, 4129 series);
 - Metric thread ring gages and plug gages (4130, 4120 series);
 - American standard thread ring gages and plug gages (4131, 4121 series)

Code example:

Original code	DLC coating code
4120-12	4120-12-DLC
4130-4	4130-4-DLC

DLC coating characteristics

Hardness	6000HV
Friction coefficient	0.15
Coating color	interference color

**WARNING: LIFE TIME IS LIMITED,
CAN BE USED ABOUT 2000 TIMES**

METRIC THREAD PLUG GAGES

13

- Supplied with Go and No-Go gages together
- Standard ISO1502
- Supplied with manufacturer inspection certificate



4130-10



Individual

Size (mm)		Code		
Nominal diameter	Pitch	Class 6H	Class 6G	Class 4H
M0.8	0.2	4130-D8	4130-D8G	4130-D8H
M0.9	0.225	4130-D9	4130-D9G	4130-D9H
M1	0.25	4130-1	4130-1G	4130-1H
M1.1	0.25	4130-1D1	4130-1D1G	4130-1D1H
M1.2	0.25	4130-1D2	4130-1D2G	4130-1D2H
M1.4	0.3	4130-1D4	4130-1D4G	4130-1D4H
M1.6	0.35	4130-1D6	4130-1D6G	4130-1D6H
M1.7	0.35	4130-1D7	4130-1D7G	4130-1D7H
M1.8	0.35	4130-1D8	4130-1D8G	4130-1D8H
M2	0.4	4130-2	4130-2G	4130-2H
M2.2	0.45	4130-2D2	4130-2D2G	4130-2D2H
M2.3	0.4	4130-2D3	4130-2D3G	4130-2D3H
M2.5	0.45	4130-2D5	4130-2D5G	4130-2D5H
M2.6	0.45	4130-2D6	4130-2D6G	4130-2D6H
M3	0.5	4130-3	4130-3G	4130-3H
M3.5	0.6	4130-3D5	4130-3D5G	4130-3D5H
M4	0.7	4130-4	4130-4G	4130-4H
M4.5	0.75	4130-4D5	4130-4D5G	4130-4D5H
M5	0.8	4130-5	4130-5G	4130-5H
M6	1	4130-6	4130-6G	4130-6H
M7	1	4130-7	4130-7G	4130-7H
M8	1.25	4130-8	4130-8G	4130-8H

Individual

Size (mm)		Code		
Nominal diameter	Pitch	Class 6H	Class 6G	Class 4H
M9	1.25	4130-9	4130-9G	4130-9H
M10	1.5	4130-10	4130-10G	4130-10H
M11	1.5	4130-11	4130-11G	4130-11H
M12	1.75	4130-12	4130-12G	4130-12H
M14	2	4130-14	4130-14G	4130-14H
M16	2	4130-16	4130-16G	4130-16H
M18	2.5	4130-18	4130-18G	4130-18H
M20	2.5	4130-20	4130-20G	4130-20H
M22	2.5	4130-22	4130-22G	4130-22H
M24	3	4130-24	4130-24G	4130-24H
M27	3	4130-27	4130-27G	4130-27H
M30	3.5	4130-30	4130-30G	4130-30H
M33	3.5	4130-33	4130-33G	4130-33H
M36	4	4130-36	4130-36G	4130-36H
M39	4	4130-39	4130-39G	4130-39H
M42	4.5	4130-42	4130-42G	4130-42H
M45	4.5	4130-45	4130-45G	4130-45H
M48	5	4130-48	4130-48G	4130-48H
M52	5	4130-52	4130-52G	4130-52H
M56	5.5	4130-56	4130-56G	4130-56H
M60	5.5	4130-60	4130-60G	4130-60H
M64	6	4130-64	4130-64G	4130-64H
M68	6	4130-68	4130-68G	4130-68H

Set (class 6H)

Code	Thread plug gages included (mm)
4130-S7	M3x0.5 (4130-3), M4x0.7 (4130-4), M5x0.8 (4130-5), M6x1 (4130-6), M8x1.25 (4130-8), M10x1.5 (4130-10), M12x1.75 (4130-12)

METRIC FINE THREAD PLUG GAGES



WARNING: LIFE TIME IS LIMITED,
CAN BE USED ABOUT 2000 TIMES



4139-20G

- Supplied with Go and No-Go gages together
- Standard ISO1502
- Supplied with manufacturer inspection certificate

Code example:
"-1A" stands for "4139-1A"

13

Size (mm)		Code (4139)		
Nominal diameter	Pitch	Class 6H	Class 6G	Class 4H
M1	0.2	-1A	-1AG	-1AH
M1.2	0.2	-1D2A	-1D2AG	-1D2AH
M1.4	0.2	-1D4A	-1D4AG	-1D4AH
M1.6	0.2	-1D6A	-1D6AG	-1D6AH
M1.8	0.2	-1D8A	-1D8AG	-1D8AH
M2	0.2	-2A	-2AG	-2AH
	0.25	-2B	-2BG	-2BH
M2.5	0.2	-2D5A	-2D5AG	-2D5AH
	0.25	-2D5B	-2D5BG	-2D5BH
	0.35	-2D5D	-2D5DG	-2D5DH
M3	0.25	-3B	-3BG	-3BH
	0.35	-3D	-3DG	-3DH
M3.5	0.25	-3D5B	-3D5BG	-3D5BH
	0.35	-3D5D	-3D5DG	-3D5DH
	0.5	-3D5G	-3D5GG	-3D5GH
M4	0.25	-4B	-4BG	-4BH
	0.35	-4D	-4DG	-4DH
	0.5	-4G	-4GG	-4GH
M4.5	0.35	-4D5D	-4D5DG	-4D5DH
	0.5	-4D5G	-4D5GG	-4D5GH
M5	0.25	-5B	-5BG	-5BH
	0.35	-5D	-5DG	-5DH
	0.5	-5G	-5GG	-5GH
M5.5	0.5	-5D5G	-5D5GG	-5D5GH
M6	0.25	-6B	-6BG	-6BH
	0.35	-6D	-6DG	-6DH
M6.5	0.5	-6G	-6GG	-6GH
	0.5	-6D5G	-6D5GG	-6D5GH
M7	0.35	-7D	-7DG	-7DH
	0.5	-7G	-7GG	-7GH
M7.5	0.5	-7D5G	-7D5GG	-7D5GH
	0.35	-8D	-8DG	-8DH
M8	0.5	-8G	-8GG	-8GH

Size (mm)		Code (4139)		
Nominal diameter	Pitch	Class 6H	Class 6G	Class 4H
M8	1	-8P	-8PG	-8PH
M8.5	0.5	-8D5G	-8D5GG	-8D5GH
	0.35	-9D	-9DG	-9DH
M9	0.5	-9G	-9GG	-9GH
	0.75	-9L	-9LG	-9LH
	1	-9P	-9PG	-9PH
M10	0.35	-10D	-10DG	-10DH
	0.5	-10G	-10GG	-10GH
	1	-10P	-10PG	-10PH
	1.25	-10Q	-10QG	-10QH
M11	0.5	-11G	-11GG	-11GH
	1	-11P	-11PG	-11PH
M12	0.5	-12G	-12GG	-12GH
	1	-12P	-12PG	-12PH
	1.25	-12Q	-12QG	-12QH
	1.5	-12R	-12RG	-12RH
M13	0.5	-13G	-13GG	-13GH
	1	-13P	-13PG	-13PH
	1.5	-13R	-13RG	-13RH
M14	0.5	-14G	-14GG	-14GH
	1	-14P	-14PG	-14PH
	1.25	-14Q	-14QG	-14QH
	1.5	-14R	-14RG	-14RH
M15	0.5	-15G	-15GG	-15GH
	1	-15P	-15PG	-15PH
	1.5	-15R	-15RG	-15RH
M16	0.5	-16G	-16GG	-16GH
	1	-16P	-16PG	-16PH
	1.25	-16Q	-16QG	-16QH
	1.5	-16R	-16RG	-16RH
M17	0.5	-17G	-17GG	-17GH
	1	-17P	-17PG	-17PH
	1.5	-17R	-17RG	-17RH

To be continued



Continued from previous page

Size (mm)		Code (4139)		
Nominal diameter	Pitch	Class 6H	Class 6G	Class 4H
M18	0.5	-18G	-18GG	-18GH
	1	-18P	-18PG	-18PH
	1.25	-18Q	-18QG	-18QH
	1.5	-18R	-18RG	-18RH
	2	-18T	-18TG	-18TH
M19	0.5	-19G	-19GG	-19GH
	1	-19P	-19PG	-19PH
	1.5	-19R	-19RG	-19RH
M20	0.5	-20G	-20GG	-20GH
	1	-20P	-20PG	-20PH
	1.25	-20Q	-20QG	-20QH
	1.5	-20R	-20RG	-20RH
	2	-20T	-20TG	-20TH
M21	0.5	-21G	-21GG	-21GH
	1	-21P	-21PG	-21PH
	1.5	-21R	-21RG	-21RH
M22	0.5	-22G	-22GG	-22GH
	1	-22P	-22PG	-22PH
	1.25	-22Q	-22QG	-22QH
	1.5	-22R	-22RG	-22RH
	2	-22T	-22TG	-22TH
M23	0.5	-23G	-23GG	-23GH
	1	-23P	-23PG	-23PH
M24	0.5	-24G	-24GG	-24GH
	1	-24P	-24PG	-24PH
	1.25	-24Q	-24QG	-24QH
	1.5	-24R	-24RG	-24RH
	2	-24T	-24TG	-24TH
M25	0.5	-25G	-25GG	-25GH
	1	-25P	-25PG	-25PH
	1.5	-25R	-25RG	-25RH
	2	-25T	-25TG	-25TH
	M26	0.5	-26G	-26GG
1		-26P	-26PG	-26PH
1.5		-26R	-26RG	-26RH
2		-26T	-26TG	-26TH
M27		0.5	-27G	-27GG
	1	-27P	-27PG	-27PH
	1.5	-27R	-27RG	-27RH
	2	-27T	-27TG	-27TH
	M28	0.5	-28G	-28GG
1		-28P	-28PG	-28PH
1.5		-28R	-28RG	-28RH
2		-28T	-28TG	-28TH
M29		0.5	-29G	-29GG
	0.75	-29L	-29LG	-29LH
	1	-29P	-29PG	-29PH
M30	0.5	-30G	-30GG	-30GH
	0.75	-30L	-30LG	-30LH
	1	-30P	-30PG	-30PH
	1.5	-30R	-30RG	-30RH
	2	-30T	-30TG	-30TH
	3	-30V	-30VG	-30VH

Size (mm)		Code (4139)		
Nominal diameter	Pitch	Class 6H	Class 6G	Class 4H
M31	0.5	-31G	-31GG	-31GH
	0.75	-31L	-31LG	-31LH
M32	0.5	-32G	-32GG	-32GH
	0.75	-32L	-32LG	-32LH
	1	-32P	-32PG	-32PH
	1.5	-32R	-32RG	-32RH
	2	-32T	-32TG	-32TH
M33	0.5	-33G	-33GG	-33GH
	0.75	-33L	-33LG	-33LH
	1	-33P	-33PG	-33PH
	1.5	-33R	-33RG	-33RH
	2	-33T	-33TG	-33TH
M34	3	-33V	-33VG	-33VH
	0.75	-34L	-34LG	-34LH
	1	-34P	-34PG	-34PH
	1.5	-34R	-34RG	-34RH
	2	-34T	-34TG	-34TH
M35	0.75	-35L	-35LG	-35LH
	1	-35P	-35PG	-35PH
	1.5	-35R	-35RG	-35RH
	2	-35T	-35TG	-35TH
	M36	0.75	-36L	-36LG
1		-36P	-36PG	-36PH
1.5		-36R	-36RG	-36RH
2		-36T	-36TG	-36TH
3		-36V	-36VG	-36VH
M37	0.75	-37L	-37LG	-37LH
M38	0.75	-38L	-38LG	-38LH
	1	-38P	-38PG	-38PH
	1.5	-38R	-38RG	-38RH
	2	-38T	-38TG	-38TH
	M39	0.75	-39L	-39LG
1		-39P	-39PG	-39PH
1.5		-39R	-39RG	-39RH
2		-39T	-39TG	-39TH
3		-39V	-39VG	-39VH
M40	0.75	-40L	-40LG	-40LH
	1	-40P	-40PG	-40PH
	1.5	-40R	-40RG	-40RH
	2	-40T	-40TG	-40TH
	3	-40V	-40VG	-40VH
M42	1	-42P	-42PG	-42PH
	1.5	-42R	-42RG	-42RH
	2	-42T	-42TG	-42TH
	3	-42V	-42VG	-42VH
	M45	1	-45P	-45PG
1.5		-45R	-45RG	-45RH
2		-45T	-45TG	-45TH
3		-45V	-45VG	-45VH
M48		1	-48P	-48PG
	1.5	-48R	-48RG	-48RH
	2	-48T	-48TG	-48TH
3	-48V	-48VG	-48VH	

To be continued

Continued from previous page

Size (mm)		Code (4139)		
Nominal diameter	Pitch	Class 6H	Class 6G	Class 4H
M50	1	-50P	-50PG	-50PH
	1.5	-50R	-50RG	-50RH
	2	-50T	-50TG	-50TH
	3	-50V	-50VG	-50VH
M52	1	-52P	-52PG	-52PH
	1.5	-52R	-52RG	-52RH
	2	-52T	-52TG	-52TH
	3	-52V	-52VG	-52VH
M55	4	-52X	-52XG	-52XH
	1	-55P	-55PG	-55PH
	1.5	-55R	-55RG	-55RH
	2	-55T	-55TG	-55TH
M56	3	-55V	-55VG	-55VH
	4	-55X	-55XG	-55XH
	1	-56P	-56PG	-56PH
	1.5	-56R	-56RG	-56RH
M58	2	-56T	-56TG	-56TH
	3	-56V	-56VG	-56VH
	4	-56X	-56XG	-56XH
	1	-58P	-58PG	-58PH
M60	1.5	-58R	-58RG	-58RH
	2	-58T	-58TG	-58TH
	3	-58V	-58VG	-58VH
	4	-58X	-58XG	-58XH
M62	1	-60P	-60PG	-60PH
	1.5	-60R	-60RG	-60RH
	2	-60T	-60TG	-60TH
	3	-60V	-60VG	-60VH
M64	4	-60X	-60XG	-60XH
	1.5	-62R	-62RG	-62RH
	2	-62T	-62TG	-62TH
	3	-62V	-62VG	-62VH
M65	4	-62X	-62XG	-62XH
	1.5	-64R	-64RG	-64RH
	2	-64T	-64TG	-64TH
	3	-64V	-64VG	-64VH
M68	4	-64X	-64XG	-64XH
	1.5	-65R	-65RG	-65RH
	2	-65T	-65TG	-65TH
	3	-65V	-65VG	-65VH
M70	4	-65X	-65XG	-65XH
	1.5	-68R	-68RG	-68RH
	2	-68T	-68TG	-68TH
	3	-68V	-68VG	-68VH
M72	4	-68X	-68XG	-68XH
	1.5	-70R	-70RG	-70RH
	2	-70T	-70TG	-70TH
	3	-70V	-70VG	-70VH
M72	4	-70X	-70XG	-70XH
	6	-70O	-70OG	-70OH
	1.5	-72R	-72RG	-72RH

Size (mm)		Code (4139)		
Nominal diameter	Pitch	Class 6H	Class 6G	Class 4H
M72	2	-72T	-72TG	-72TH
	3	-72V	-72VG	-72VH
	4	-72X	-72XG	-72XH
	6	-72O	-72OG	-72OH
M75	1.5	-75R	-75RG	-75RH
	2	-75T	-75TG	-75TH
	3	-75V	-75VG	-75VH
	4	-75X	-75XG	-75XH
M76	1.5	-76R	-76RG	-76RH
	2	-76T	-76TG	-76TH
	3	-76V	-76VG	-76VH
	4	-76X	-76XG	-76XH
M78	6	-76O	-76OG	-76OH
	2	-78T	-78TG	-78TH
	1.5	-80R	-80RG	-80RH
	2	-80T	-80TG	-80TH
M80	3	-80V	-80VG	-80VH
	4	-80X	-80XG	-80XH
	6	-80O	-80OG	-80OH
	2	-82T	-82TG	-82TH
M82	2	-85T	-85TG	-85TH
	3	-85V	-85VG	-85VH
	4	-85X	-85XG	-85XH
	6	-85O	-85OG	-85OH
M85	2	-90T	-90TG	-90TH
	3	-90V	-90VG	-90VH
	4	-90X	-90XG	-90XH
	6	-90O	-90OG	-90OH
M90	2	-95T	-95TG	-95TH
	3	-95V	-95VG	-95VH
	4	-95X	-95XG	-95XH
	6	-95O	-95OG	-95OH
M95	2	-100T	-100TG	-100TH
	3	-100V	-100VG	-100VH
	4	-100X	-100XG	-100XH
	6	-100O	-100OG	-100OH
M100	2	-105T	-105TG	-105TH
	3	-105V	-105VG	-105VH
	4	-105X	-105XG	-105XH
	6	-105O	-105OG	-105OH
M105	2	-110T	-110TG	-110TH
	3	-110V	-110VG	-110VH
	4	-110X	-110XG	-110XH
	6	-110O	-110OG	-110OH
M110	2	-115T	-115TG	-115TH
	3	-115V	-115VG	-115VH
	4	-115X	-115XG	-115XH
	6	-115O	-115OG	-115OH
M115	2	-120T	-120TG	-120TH
	3	-120V	-120VG	-120VH
	4	-120X	-120XG	-120XH
	6	-120O	-120OG	-120OH

WARNING: LIFE TIME IS LIMITED,
CAN BE USED ABOUT 2000 TIMES



METRIC THREAD RING GAGES

- Standard ISO1502
- Supplied with manufacturer inspection certificate



4120-16



4120-16N

Code example:
“-2” stands for “4120-2”

Individual

Size (mm)		Code (4120)					
		Class 6g		Class 6e		Class 6h	
Nominal diameter	Pitch	GO	NOGO	GO	NOGO	GO	NOGO
M2	0.4	-2	-2N	-2E	-2EN	-2H	-2HN
M2.2	0.45	-2D2	-2D2N	-2D2E	-2D2EN	-2D2H	-2D2HN
M2.3	0.4	-2D3	-2D3N	-2D3E	-2D3EN	-2D3H	-2D3HN
M2.5	0.45	-2D5	-2D5N	-2D5E	-2D5EN	-2D5H	-2D5HN
M2.6	0.45	-2D6	-2D6N	-2D6E	-2D6EN	-2D6H	-2D6HN
M3	0.5	-3	-3N	-3E	-3EN	-3H	-3HN
M3.5	0.6	-3D5	-3D5N	-3D5E	-3D5EN	-3D5H	-3D5HN
M4	0.7	-4	-4N	-4E	-4EN	-4H	-4HN
M4.5	0.75	-4D5	-4D5N	-4D5E	-4D5EN	-4D5H	-4D5HN
M5	0.8	-5	-5N	-5E	-5EN	-5H	-5HN
M6	1	-6	-6N	-6E	-6EN	-6H	-6HN
M7	1	-7	-7N	-7E	-7EN	-7H	-7HN
M8	1.25	-8	-8N	-8E	-8EN	-8H	-8HN
M9	1.25	-9	-9N	-9E	-9EN	-9H	-9HN
M10	1.5	-10	-10N	-10E	-10EN	-10H	-10HN
M11	1.5	-11	-11N	-11E	-11EN	-11H	-11HN
M12	1.75	-12	-12N	-12E	-12EN	-12H	-12HN
M14	2	-14	-14N	-14E	-14EN	-14H	-14HN
M16	2	-16	-16N	-16E	-16EN	-16H	-16HN
M18	2.5	-18	-18N	-18E	-18EN	-18H	-18HN
M20	2.5	-20	-20N	-20E	-20EN	-20H	-20HN
M22	2.5	-22	-22N	-22E	-22EN	-22H	-22HN
M24	3	-24	-24N	-24E	-24EN	-24H	-24HN
M27	3	-27	-27N	-27E	-27EN	-27H	-27HN
M30	3.5	-30	-30N	-30E	-30EN	-30H	-30HN
M33	3.5	-33	-33N	-33E	-33EN	-33H	-33HN
M36	4	-36	-36N	-36E	-36EN	-36H	-36HN
M39	4	-39	-39N	-39E	-39EN	-39H	-39HN
M42	4.5	-42	-42N	-42E	-42EN	-42H	-42HN
M45	4.5	-45	-45N	-45E	-45EN	-45H	-45HN
M48	5	-48	-48N	-48E	-48EN	-48H	-48HN
M52	5	-52	-52N	-52E	-52EN	-52H	-52HN
M56	5.5	-56	-56N	-56E	-56EN	-56H	-56HN
M60	5.5	-60	-60N	-60E	-60EN	-60H	-60HN
M64	6	-64	-64N	-64E	-64EN	-64H	-64HN
M68	6	-68	-68N	-68E	-68EN	-68H	-68HN

Go ring gage set (Class 6g)

Code	Thread ring gages included (mm)
4120-S7	M3x0.5 (4120-3), M4x0.7 (4120-4), M5x0.8 (4120-5), M6x1 (4120-6), M8x1.25 (4120-8), M10x1.5 (4120-10), M12x1.75 (4120-12)

No Go ring gage set (Class 6g)

Code	Thread ring gages included (mm)
4120-S7N	M3x0.5 (4120-3N), M4x0.7 (4120-4N), M5x0.8 (4120-5N), M6x1 (4120-6N), M8x1.25 (4120-8N), M10x1.5 (4120-10N), M12x1.75 (4120-12N)

METRIC FINE THREAD RING GAGES



WARNING: LIFE TIME IS LIMITED,
CAN BE USED ABOUT 2000 TIMES

- Standard ISO1502
- Supplied with manufacturer inspection certificate (except gages larger than M100)



4129-10P



4129-10PN

Code example:
"3D5G" stands for "4129-3D5G"

Size (mm)		Code (4129)					
Nominal diameter	Pitch	Class 6g		Class 6e		Class 6h	
		GO	NOGO	GO	NOGO	GO	NOGO
M3.5	0.5	-3D5G	-3D5GN	-3D5GE	-3D5GEN	-3D5GH	-3D5GHN
M4	0.5	-4G	-4GN	-4GE	-4GEN	-4GH	-4GHN
M4.5	0.5	-4D5G	-4D5GN	-4D5GE	-4D5GEN	-4D5GH	-4D5GHN
M5	0.5	-5G	-5GN	-5GE	-5GEN	-5GH	-5GHN
M5.5	0.5	-5D5G	-5D5GN	-5D5GE	-5D5GEN	-5D5GH	-5D5GHN
M6	0.5	-6G	-6GN	-6GE	-6GEN	-6GH	-6GHN
	0.75	-6L	-6LN	-6LE	-6LEN	-6LH	-6LHN
M6.5	0.5	-6D5G	-6D5GN	-6D5GE	-6D5GEN	-6D5GH	-6D5GHN
M7	0.5	-7G	-7GN	-7GE	-7GEN	-7GH	-7GHN
	0.75	-7L	-7LN	-7LE	-7LEN	-7LH	-7LHN
M7.5	0.5	-7D5G	-7D5GN	-7D5GE	-7D5GEN	-7D5GH	-7D5GHN
	0.5	-8G	-8GN	-8GE	-8GEN	-8GH	-8GHN
M8	0.75	-8L	-8LN	-8LE	-8LEN	-8LH	-8LHN
	1	-8P	-8PN	-8PE	-8PEN	-8PH	-8PHN
M8.5	0.5	-8D5G	-8D5GN	-8D5GE	-8D5GEN	-8D5GH	-8D5GHN
M9	0.5	-9G	-9GN	-9GE	-9GEN	-9GH	-9GHN
	0.75	-9L	-9LN	-9LE	-9LEN	-9LH	-9LHN
	1	-9P	-9PN	-9PE	-9PEN	-9PH	-9PHN
M10	0.5	-10G	-10GN	-10GE	-10GEN	-10GH	-10GHN
	0.75	-10L	-10LN	-10LE	-10LEN	-10LH	-10LHN
	1	-10P	-10PN	-10PE	-10PEN	-10PH	-10PHN
	1.25	-10Q	-10QN	-10QE	-10QEN	-10QH	-10QHN
M11	0.5	-11G	-11GN	-11GE	-11GEN	-11GH	-11GHN
	0.75	-11L	-11LN	-11LE	-11LEN	-11LH	-11LHN
	1	-11P	-11PN	-11PE	-11PEN	-11PH	-11PHN
M12	0.5	-12G	-12GN	-12GE	-12GEN	-12GH	-12GHN
	0.75	-12L	-12LN	-12LE	-12LEN	-12LH	-12LHN
	1	-12P	-12PN	-12PE	-12PEN	-12PH	-12PHN
	1.25	-12Q	-12QN	-12QE	-12QEN	-12QH	-12QHN
M13	1.5	-12R	-12RN	-12RE	-12REN	-12RH	-12RHN
	0.5	-13G	-13GN	-13GE	-13GEN	-13GH	-13GHN
	0.75	-13L	-13LN	-13LE	-13LEN	-13LH	-13LHN
	1	-13P	-13PN	-13PE	-13PEN	-13PH	-13PHN
M14	1.5	-13R	-13RN	-13RE	-13REN	-13RH	-13RHN
	0.5	-14G	-14GN	-14GE	-14GEN	-14GH	-14GHN
	0.75	-14L	-14LN	-14LE	-14LEN	-14LH	-14LHN
	1	-14P	-14PN	-14PE	-14PEN	-14PH	-14PHN
M14	1.25	-14Q	-14QN	-14QE	-14QEN	-14QH	-14QHN
	1.5	-14R	-14RN	-14RE	-14REN	-14RH	-14RHN

To be continued



Continued from previous page

Size (mm)		Code (4129)					
Nominal diameter	Pitch	Class 6g		Class 6e		Class 6h	
		GO	NOGO	GO	NOGO	GO	NOGO
M15	0.5	-15G	-15GN	-15GE	-15GEN	-15GH	-15GHN
	0.75	-15L	-15LN	-15LE	-15LEN	-15LH	-15LHN
	1	-15P	-15PN	-15PE	-15PEN	-15PH	-15PHN
	1.5	-15R	-15RN	-15RE	-15REN	-15RH	-15RHN
M16	0.5	-16G	-16GN	-16GE	-16GEN	-16GH	-16GHN
	0.75	-16L	-16LN	-16LE	-16LEN	-16LH	-16LHN
	1	-16P	-16PN	-16PE	-16PEN	-16PH	-16PHN
	1.25	-16Q	-16QN	-16QE	-16QEN	-16QH	-16QHN
	1.5	-16R	-16RN	-16RE	-16REN	-16RH	-16RHN
M17	0.5	-17G	-17GN	-17GE	-17GEN	-17GH	-17GHN
	0.75	-17L	-17LN	-17LE	-17LEN	-17LH	-17LHN
	1	-17P	-17PN	-17PE	-17PEN	-17PH	-17PHN
	1.5	-17R	-17RN	-17RE	-17REN	-17RH	-17RHN
M18	0.5	-18G	-18GN	-18GE	-18GEN	-18GH	-18GHN
	0.75	-18L	-18LN	-18LE	-18LEN	-18LH	-18LHN
	1	-18P	-18PN	-18PE	-18PEN	-18PH	-18PHN
	1.25	-18Q	-18QN	-18QE	-18QEN	-18QH	-18QHN
	1.5	-18R	-18RN	-18RE	-18REN	-18RH	-18RHN
	2	-18T	-18TN	-18TE	-18TEN	-18TH	-18THN
M19	0.5	-19G	-19GN	-19GE	-19GEN	-19GH	-19GHN
	0.75	-19L	-19LN	-19LE	-19LEN	-19LH	-19LHN
	1	-19P	-19PN	-19PE	-19PEN	-19PH	-19PHN
	1.5	-19R	-19RN	-19RE	-19REN	-19RH	-19RHN
M20	0.5	-20G	-20GN	-20GE	-20GEN	-20GH	-20GHN
	0.75	-20L	-20LN	-20LE	-20LEN	-20LH	-20LHN
	1	-20P	-20PN	-20PE	-20PEN	-20PH	-20PHN
	1.25	-20Q	-20QN	-20QE	-20QEN	-20QH	-20QHN
	1.5	-20R	-20RN	-20RE	-20REN	-20RH	-20RHN
	2	-20T	-20TN	-20TE	-20TEN	-20TH	-20THN
M21	0.75	-21L	-21LN	-21LE	-21LEN	-21LH	-21LHN
	1	-21P	-21PN	-21PE	-21PEN	-21PH	-21PHN
	1.5	-21R	-21RN	-21RE	-21REN	-21RH	-21RHN
M22	0.75	-22L	-22LN	-22LE	-22LEN	-22LH	-22LHN
	1	-22P	-22PN	-22PE	-22PEN	-22PH	-22PHN
	1.25	-22Q	-22QN	-22QE	-22QEN	-22QH	-22QHN
	1.5	-22R	-22RN	-22RE	-22REN	-22RH	-22RHN
	2	-22T	-22TN	-22TE	-22TEN	-22TH	-22THN
M23	0.75	-23L	-23LN	-23LE	-23LEN	-23LH	-23LHN
	1	-23P	-23PN	-23PE	-23PEN	-23PH	-23PHN
M24	0.75	-24L	-24LN	-24LE	-24LEN	-24LH	-24LHN
	1	-24P	-24PN	-24PE	-24PEN	-24PH	-24PHN
	1.25	-24Q	-24QN	-24QE	-24QEN	-24QH	-24QHN
	1.5	-24R	-24RN	-24RE	-24REN	-24RH	-24RHN
	2	-24T	-24TN	-24TE	-24TEN	-24TH	-24THN
M25	0.75	-25L	-25LN	-25LE	-25LEN	-25LH	-25LHN
	1	-25P	-25PN	-25PE	-25PEN	-25PH	-25PHN
	1.5	-25R	-25RN	-25RE	-25REN	-25RH	-25RHN
	2	-25T	-25TN	-25TE	-25TEN	-25TH	-25THN
M26	0.75	-26L	-26LN	-26LE	-26LEN	-26LH	-26LHN
	1	-26P	-26PN	-26PE	-26PEN	-26PH	-26PHN
	1.5	-26R	-26RN	-26RE	-26REN	-26RH	-26RHN
	2	-26T	-26TN	-26TE	-26TEN	-26TH	-26THN

To be continued

Continued from previous page

Size (mm)		Code (4129)					
Nominal diameter	Pitch	Class 6g		Class 6e		Class 6h	
		GO	NOGO	GO	NOGO	GO	NOGO
M27	0.75	-27L	-27LN	-27LE	-27LEN	-27LH	-27LHN
	1	-27P	-27PN	-27PE	-27PEN	-27PH	-27PHN
	1.5	-27R	-27RN	-27RE	-27REN	-27RH	-27RHN
	2	-27T	-27TN	-27TE	-27TEN	-27TH	-27THN
M28	0.75	-28L	-28LN	-28LE	-28LEN	-28LH	-28LHN
	1	-28P	-28PN	-28PE	-28PEN	-28PH	-28PHN
	1.5	-28R	-28RN	-28RE	-28REN	-28RH	-28RHN
	2	-28T	-28TN	-28TE	-28TEN	-28TH	-28THN
M29	0.75	-29L	-29LN	-29LE	-29LEN	-29LH	-29LHN
	1	-29P	-29PN	-29PE	-29PEN	-29PH	-29PHN
M30	0.75	-30L	-30LN	-30LE	-30LEN	-30LH	-30LHN
	1	-30P	-30PN	-30PE	-30PEN	-30PH	-30PHN
	1.5	-30R	-30RN	-30RE	-30REN	-30RH	-30RHN
	2	-30T	-30TN	-30TE	-30TEN	-30TH	-30THN
	3	-30V	-30VN	-30VE	-30VEN	-30VH	-30VHN
M31	0.75	-31L	-31LN	-31LE	-31LEN	-31LH	-31LHN
M32	0.75	-32L	-32LN	-32LE	-32LEN	-32LH	-32LHN
	1	-32P	-32PN	-32PE	-32PEN	-32PH	-32PHN
	1.5	-32R	-32RN	-32RE	-32REN	-32RH	-32RHN
	2	-32T	-32TN	-32TE	-32TEN	-32TH	-32THN
M33	0.75	-33L	-33LN	-33LE	-33LEN	-33LH	-33LHN
	1	-33P	-33PN	-33PE	-33PEN	-33PH	-33PHN
	1.5	-33R	-33RN	-33RE	-33REN	-33RH	-33RHN
	2	-33T	-33TN	-33TE	-33TEN	-33TH	-33THN
M34	3	-33V	-33VN	-33VE	-33VEN	-33VH	-33VHN
	1	-34P	-34PN	-34PE	-34PEN	-34PH	-34PHN
	1.5	-34R	-34RN	-34RE	-34REN	-34RH	-34RHN
M35	2	-34T	-34TN	-34TE	-34TEN	-34TH	-34THN
	1	-35P	-35PN	-35PE	-35PEN	-35PH	-35PHN
	1.5	-35R	-35RN	-35RE	-35REN	-35RH	-35RHN
M36	2	-35T	-35TN	-35TE	-35TEN	-35TH	-35THN
	1	-36P	-36PN	-36PE	-36PEN	-36PH	-36PHN
	1.5	-36R	-36RN	-36RE	-36REN	-36RH	-36RHN
	2	-36T	-36TN	-36TE	-36TEN	-36TH	-36THN
M38	3	-36V	-36VN	-36VE	-36VEN	-36VH	-36VHN
	1	-38P	-38PN	-38PE	-38PEN	-38PH	-38PHN
	1.5	-38R	-38RN	-38RE	-38REN	-38RH	-38RHN
M39	2	-38T	-38TN	-38TE	-38TEN	-38TH	-38THN
	1	-39P	-39PN	-39PE	-39PEN	-39PH	-39PHN
	1.5	-39R	-39RN	-39RE	-39REN	-39RH	-39RHN
	2	-39T	-39TN	-39TE	-39TEN	-39TH	-39THN
M40	3	-39V	-39VN	-39VE	-39VEN	-39VH	-39VHN
	1.5	-40R	-40RN	-40RE	-40REN	-40RH	-40RHN
	2	-40T	-40TN	-40TE	-40TEN	-40TH	-40THN
M42	3	-40V	-40VN	-40VE	-40VEN	-40VH	-40VHN
	1.5	-42R	-42RN	-42RE	-42REN	-42RH	-42RHN
	2	-42T	-42TN	-42TE	-42TEN	-42TH	-42THN
M45	3	-42V	-42VN	-42VE	-42VEN	-42VH	-42VHN
	1.5	-45R	-45RN	-45RE	-45REN	-45RH	-45RHN
	2	-45T	-45TN	-45TE	-45TEN	-45TH	-45THN
	3	-45V	-45VN	-45VE	-45VEN	-45VH	-45VHN

To be continued



Continued from previous page

Size (mm)		Code (4129)					
Nominal diameter	Pitch	Class 6g		Class 6e		Class 6h	
		GO	NOGO	GO	NOGO	GO	NOGO
M48	1.5	-48R	-48RN	-48RE	-48REN	-48RH	-48RHN
	2	-48T	-48TN	-48TE	-48TEN	-48TH	-48THN
	3	-48V	-48VN	-48VE	-48VEN	-48VH	-48VHN
M50	1.5	-50R	-50RN	-50RE	-50REN	-50RH	-50RHN
	2	-50T	-50TN	-50TE	-50TEN	-50TH	-50THN
	3	-50V	-50VN	-50VE	-50VEN	-50VH	-50VHN
M52	1.5	-52R	-52RN	-52RE	-52REN	-52RH	-52RHN
	2	-52T	-52TN	-52TE	-52TEN	-52TH	-52THN
	3	-52V	-52VN	-52VE	-52VEN	-52VH	-52VHN
	4	-52X	-52XN	-52XE	-52XEN	-52XH	-52XHN
M55	1.5	-55R	-55RN	-55RE	-55REN	-55RH	-55RHN
	2	-55T	-55TN	-55TE	-55TEN	-55TH	-55THN
	3	-55V	-55VN	-55VE	-55VEN	-55VH	-55VHN
	4	-55X	-55XN	-55XE	-55XEN	-55XH	-55XHN
M56	1.5	-56R	-56RN	-56RE	-56REN	-56RH	-56RHN
	2	-56T	-56TN	-56TE	-56TEN	-56TH	-56THN
	3	-56V	-56VN	-56VE	-56VEN	-56VH	-56VHN
	4	-56X	-56XN	-56XE	-56XEN	-56XH	-56XHN
M58	1.5	-58R	-58RN	-58RE	-58REN	-58RH	-58RHN
	2	-58T	-58TN	-58TE	-58TEN	-58TH	-58THN
	3	-58V	-58VN	-58VE	-58VEN	-58VH	-58VHN
	4	-58X	-58XN	-58XE	-58XEN	-58XH	-58XHN
M60	1.5	-60R	-60RN	-60RE	-60REN	-60RH	-60RHN
	2	-60T	-60TN	-60TE	-60TEN	-60TH	-60THN
	3	-60V	-60VN	-60VE	-60VEN	-60VH	-60VHN
	4	-60X	-60XN	-60XE	-60XEN	-60XH	-60XHN
M62	1.5	-62R	-62RN	-62RE	-62REN	-62RH	-62RHN
	2	-62T	-62TN	-62TE	-62TEN	-62TH	-62THN
	3	-62V	-62VN	-62VE	-62VEN	-62VH	-62VHN
	4	-62X	-62XN	-62XE	-62XEN	-62XH	-62XHN
M64	1.5	-64R	-64RN	-64RE	-64REN	-64RH	-64RHN
	2	-64T	-64TN	-64TE	-64TEN	-64TH	-64THN
	3	-64V	-64VN	-64VE	-64VEN	-64VH	-64VHN
	4	-64X	-64XN	-64XE	-64XEN	-64XH	-64XHN
M65	1.5	-65R	-65RN	-65RE	-65REN	-65RH	-65RHN
	2	-65T	-65TN	-65TE	-65TEN	-65TH	-65THN
	3	-65V	-65VN	-65VE	-65VEN	-65VH	-65VHN
	4	-65X	-65XN	-65XE	-65XEN	-65XH	-65XHN
M68	1.5	-68R	-68RN	-68RE	-68REN	-68RH	-68RHN
	2	-68T	-68TN	-68TE	-68TEN	-68TH	-68THN
	3	-68V	-68VN	-68VE	-68VEN	-68VH	-68VHN
	4	-68X	-68XN	-68XE	-68XEN	-68XH	-68XHN
M70	1.5	-70R	-70RN	-70RE	-70REN	-70RH	-70RHN
	2	-70T	-70TN	-70TE	-70TEN	-70TH	-70THN
	3	-70V	-70VN	-70VE	-70VEN	-70VH	-70VHN
	4	-70X	-70XN	-70XE	-70XEN	-70XH	-70XHN
	6	-70O	-70ON	-70OE	-70OEN	-70OH	-70OHN
M72	1.5	-72R	-72RN	-72RE	-72REN	-72RH	-72RHN
	2	-72T	-72TN	-72TE	-72TEN	-72TH	-72THN

To be continued

Continued from previous page

Size (mm)		Code (4129)					
Nominal diameter	Pitch	Class 6g		Class 6e		Class 6h	
		GO	NOGO	GO	NOGO	GO	NOGO
M72	3	-72V	-72VN	-72VE	-72VEN	-72VH	-72VHN
	4	-72X	-72XN	-72XE	-72XEN	-72XH	-72XHN
	6	-72O	-72ON	-72OE	-72OEN	-72OH	-72OHN
M75	1.5	-75R	-75RN	-75RE	-75REN	-75RH	-75RHN
	2	-75T	-75TN	-75TE	-75TEN	-75TH	-75THN
	3	-75V	-75VN	-75VE	-75VEN	-75VH	-75VHN
	4	-75X	-75XN	-75XE	-75XEN	-75XH	-75XHN
M76	1.5	-76R	-76RN	-76RE	-76REN	-76RH	-76RHN
	2	-76T	-76TN	-76TE	-76TEN	-76TH	-76THN
	3	-76V	-76VN	-76VE	-76VEN	-76VH	-76VHN
	4	-76X	-76XN	-76XE	-76XEN	-76XH	-76XHN
M78	6	-76O	-76ON	-76OE	-76OEN	-76OH	-76OHN
	2	-78T	-78TN	-78TE	-78TEN	-78TH	-78THN
M80	1.5	-80R	-80RN	-80RE	-80REN	-80RH	-80RHN
	2	-80T	-80TN	-80TE	-80TEN	-80TH	-80THN
	3	-80V	-80VN	-80VE	-80VEN	-80VH	-80VHN
	4	-80X	-80XN	-80XE	-80XEN	-80XH	-80XHN
M82	6	-80O	-80ON	-80OE	-80OEN	-80OH	-80OHN
	2	-82T	-82TN	-82TE	-82TEN	-82TH	-82THN
M85	2	-85T	-85TN	-85TE	-85TEN	-85TH	-85THN
	3	-85V	-85VN	-85VE	-85VEN	-85VH	-85VHN
	4	-85X	-85XN	-85XE	-85XEN	-85XH	-85XHN
	6	-85O	-85ON	-85OE	-85OEN	-85OH	-85OHN
M90	2	-90T	-90TN	-90TE	-90TEN	-90TH	-90THN
	3	-90V	-90VN	-90VE	-90VEN	-90VH	-90VHN
	4	-90X	-90XN	-90XE	-90XEN	-90XH	-90XHN
	6	-90O	-90ON	-90OE	-90OEN	-90OH	-90OHN
M95	2	-95T	-95TN	-95TE	-95TEN	-95TH	-95THN
	3	-95V	-95VN	-95VE	-95VEN	-95VH	-95VHN
	4	-95X	-95XN	-95XE	-95XEN	-95XH	-95XHN
	6	-95O	-95ON	-95OE	-95OEN	-95OH	-95OHN
M100	2	-100T	-100TN	-100TE	-100TEN	-100TH	-100THN
	3	-100V	-100VN	-100VE	-100VEN	-100VH	-100VHN
	4	-100X	-100XN	-100XE	-100XEN	-100XH	-100XHN
	6	-100O	-100ON	-100OE	-100OEN	-100OH	-100OHN
M105	2	-105T	-105TN	-105TE	-105TEN	-105TH	-105THN
	3	-105V	-105VN	-105VE	-105VEN	-105VH	-105VHN
	4	-105X	-105XN	-105XE	-105XEN	-105XH	-105XHN
	6	-105O	-105ON	-105OE	-105OEN	-105OH	-105OHN
M110	2	-110T	-110TN	-110TE	-110TEN	-110TH	-110THN
	3	-110V	-110VN	-110VE	-110VEN	-110VH	-110VHN
	4	-110X	-110XN	-110XE	-110XEN	-110XH	-110XHN
	6	-110O	-110ON	-110OE	-110OEN	-110OH	-110OHN
M115	2	-115T	-115TN	-115TE	-115TEN	-115TH	-115THN
	3	-115V	-115VN	-115VE	-115VEN	-115VH	-115VHN
	4	-115X	-115XN	-115XE	-115XEN	-115XH	-115XHN
	6	-115O	-115ON	-115OE	-115OEN	-115OH	-115OHN
M120	2	-120T	-120TN	-120TE	-120TEN	-120TH	-120THN
	3	-120V	-120VN	-120VE	-120VEN	-120VH	-120VHN
	4	-120X	-120XN	-120XE	-120XEN	-120XH	-120XHN
	6	-120O	-120ON	-120OE	-120OEN	-120OH	-120OHN



**WARNING: LIFE TIME IS LIMITED,
CAN BE USED ABOUT 2000 TIMES**



AMERICAN STANDARD THREAD PLUG GAGES

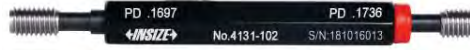

4131-102

- Supplied with Go and No-Go gages together
- Standard ANSI/ASME B1.2
- Supplied with manufacturer inspection certificate

Size	Code	
	Class 2B	Class 3B
No. 0-80UNF	4131-02	4131-02B
No. 1-64UNC	4131-11	4131-11B
No. 1-72UNF	4131-12	4131-12B
No. 2-56UNC	4131-21	4131-21B
No. 2-64UNF	4131-22	4131-22B
No. 3-48UNC	4131-31	4131-31B
No. 3-56UNF	4131-32	4131-32B
No. 4-40UNC	4131-41	4131-41B
No. 4-48UNF	4131-42	4131-42B
No. 5-40UNC	4131-51	4131-51B
No. 5-44UNF	4131-52	4131-52B
No. 6-32UNC	4131-61	4131-61B
No. 6-40UNF	4131-62	4131-62B
No. 8-32UNC	4131-81	4131-81B
No. 8-36UNF	4131-82	4131-82B
No. 10-24UNC	4131-101	4131-101B
No. 10-32UNF	4131-102	4131-102B
No. 12-24UNC	4131-121	4131-121B
No. 12-28UNF	4131-122	4131-122B
No. 12-32UNEF	4131-123	4131-123B
1/4-20UNC	4131-1B1	4131-1B1B
1/4-28UNF	4131-1B2	4131-1B2B
1/4-32UNEF	4131-1B3	4131-1B3B
1/4-36UNS	4131-1B4	4131-1B4B
5/16-18UNC	4131-5D1	4131-5D1B
5/16-24UNF	4131-5D2	4131-5D2B
5/16-32UNEF	4131-5D3	4131-5D3B
3/8-16UNC	4131-3C1	4131-3C1B
3/8-24UNF	4131-3C2	4131-3C2B
3/8-32UNEF	4131-3C3	4131-3C3B
7/16-14UNC	4131-7D1	4131-7D1B
7/16-20UNF	4131-7D2	4131-7D2B
7/16-28UNEF	4131-7D3	4131-7D3B
1/2-13UNC	4131-1A1	4131-1A1B
1/2-20UNF	4131-1A2	4131-1A2B
1/2-28UNEF	4131-1A3	4131-1A3B

Size	Code	
	Class 2B	Class 3B
9/16-12UNC	4131-9D1	4131-9D1B
9/16-18UNF	4131-9D2	4131-9D2B
9/16-24UNEF	4131-9D3	4131-9D3B
5/8-11UNC	4131-5C1	4131-5C1B
5/8-18UNF	4131-5C2	4131-5C2B
5/8-24UNEF	4131-5C3	4131-5C3B
11/16-16UN	4131-11D516	4131-11D516B
11/16-24UNEF	4131-11D3	4131-11D3B
3/4-10UNC	4131-3B1	4131-3B1B
3/4-16UNF	4131-3B2	4131-3B2B
3/4-20UNEF	4131-3B3	4131-3B3B
13/16-16UN	4131-13D516	4131-13D516B
13/16-20UNEF	4131-13D3	4131-13D3B
7/8-9UNC	4131-7C1	4131-7C1B
7/8-14UNF	4131-7C2	4131-7C2B
7/8-16UN	4131-7C516	4131-7C516B
7/8-20UNEF	4131-7C3	4131-7C3B
15/16-20UNEF	4131-15D3	4131-15D3B
1-8UNC	4131-2A1	4131-2A1B
1-12UNF	4131-2A2	4131-2A2B
1-14UNS	4131-2A514	4131-2A514B
1-20UNEF	4131-2A3	4131-2A3B
1-32UN	4131-2A532	4131-2A532B
1 1/16-12UN	4131-1E512	4131-1E512B
1 1/16-18UNEF	4131-1E3	4131-1E3B
1 1/8-7UNC	4131-1F1	4131-1F1B
1 1/8-8UN	4131-1F58	4131-1F58B
1 1/8-12UNF	4131-1F2	4131-1F2B
1 1/8-18UNEF	4131-1F3	4131-1F3B
1 3/16-12UN	4131-3E512	4131-3E512B
1 3/16-18UNEF	4131-3E3	4131-3E3B
1 1/4-7UNC	4131-1G1	4131-1G1B
1 1/4-8UN	4131-1G58	4131-1G58B
1 1/4-12UNF	4131-1G2	4131-1G2B
1 1/4-18UNEF	4131-1G3	4131-1G3B
1 5/16-12UN	4131-5E512	4131-5E512B

AMERICAN STANDARD THREAD RING GAGES



WARNING: LIFE TIME IS LIMITED,
CAN BE USED ABOUT 2000 TIMES



front

back

4121-1B1



front

back

4121-1B1N

- Standard ANSI/ASME B1.2
- Class 2A
- Supplied with manufacturer inspection certificate

13

Size	Code	
	GO	NOGO
No. 4-40UNC	4121-41	4121-41N
No. 4-48UNF	4121-42	4121-42N
No. 5-40UNC	4121-51	4121-51N
No. 5-44UNF	4121-52	4121-52N
No. 6-32UNC	4121-61	4121-61N
No. 6-40UNF	4121-62	4121-62N
No. 8-32UNC	4121-81	4121-81N
No. 8-36UNF	4121-82	4121-82N
No. 10-24UNC	4121-101	4121-101N
No. 10-32UNF	4121-102	4121-102N
No. 12-24UNC	4121-121	4121-121N
No. 12-28UNF	4121-122	4121-122N
No. 12-32UNEF	4121-123	4121-123N
1/4-20UNC	4121-1B1	4121-1B1N
1/4-28UNF	4121-1B2	4121-1B2N
1/4-32UNEF	4121-1B3	4121-1B3N
1/4-36UNS	4121-1B4	4121-1B4N
5/16-18UNC	4121-5D1	4121-5D1N
5/16-24UNF	4121-5D2	4121-5D2N
5/16-32UNEF	4121-5D3	4121-5D3N
3/8-16UNC	4121-3C1	4121-3C1N
3/8-24UNF	4121-3C2	4121-3C2N
3/8-32UNEF	4121-3C3	4121-3C3N
7/16-14UNC	4121-7D1	4121-7D1N
7/16-20UNF	4121-7D2	4121-7D2N
7/16-28UNEF	4121-7D3	4121-7D3N
1/2-13UNC	4121-1A1	4121-1A1N
1/2-20UNF	4121-1A2	4121-1A2N
1/2-28UNEF	4121-1A3	4121-1A3N
9/16-12UNC	4121-9D1	4121-9D1N
9/16-18UNF	4121-9D2	4121-9D2N
9/16-24UNEF	4121-9D3	4121-9D3N

Size	Code	
	GO	NOGO
5/8-11UNC	4121-5C1	4121-5C1N
5/8-18UNF	4121-5C2	4121-5C2N
5/8-24UNEF	4121-5C3	4121-5C3N
11/16-16UN	4121-11D516	4121-11D516N
11/16-24UNEF	4121-11D3	4121-11D3N
3/4-10UNC	4121-3B1	4121-3B1N
3/4-16UNF	4121-3B2	4121-3B2N
3/4-20UNEF	4121-3B3	4121-3B3N
13/16-16UN	4121-13D516	4121-13D516N
13/16-20UNEF	4121-13D3	4121-13D3N
7/8-9UNC	4121-7C1	4121-7C1N
7/8-14UNF	4121-7C2	4121-7C2N
7/8-16UN	4121-7C516	4121-7C516N
7/8-20UNEF	4121-7C3	4121-7C3N
15/16-20UNEF	4121-15D3	4121-15D3N
1-8UNC	4121-2A1	4121-2A1N
1-12UNF	4121-2A2	4121-2A2N
1-14UNS	4121-2A514	4121-2A514N
1-20UNEF	4121-2A3	4121-2A3N
1-32UN	4121-2A532	4121-2A532N
1 1/16-12UN	4121-1E512	4121-1E512N
1 1/16-18UNEF	4121-1E3	4121-1E3N
1 1/8-7UNC	4121-1F1	4121-1F1N
1 1/8-8UN	4121-1F58	4121-1F58N
1 1/8-12UNF	4121-1F2	4121-1F2N
1 1/8-18UNEF	4121-1F3	4121-1F3N
1 3/16-12UN	4121-3E512	4121-3E512N
1 3/16-18UNEF	4121-3E3	4121-3E3N
1 1/4-7UNC	4121-1G1	4121-1G1N
1 1/4-8UN	4121-1G58	4121-1G58N
1 1/4-12UNF	4121-1G2	4121-1G2N
1 1/4-18UNEF	4121-1G3	4121-1G3N
1 5/16-12UN	4121-5E512	4121-5E512N

WARNING: LIFE TIME IS LIMITED,
CAN BE USED ABOUT 2000 TIMES



CHECK PLUGS FOR METRIC THREAD RING GAGES



4647-10

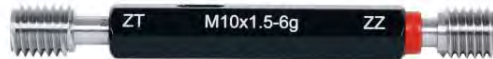

4647-10N

- Standard ISO1502
- Check thread ring gages
- Supplied with manufacturer inspection certificate

Code example:
“-2” stands for “4647-2”

Size (mm)		Code (4647)					
		Class 6g		Class 6e		Class 6h	
Nominal diameter	Pitch	GO	NOGO	GO	NOGO	GO	NOGO
M2	0.4	-2	-2N	-2E	-2EN	-2H	-2HN
M2.2	0.45	-2D2	-2D2N	-2D2E	-2D2EN	-2D2H	-2D2HN
M2.3	0.4	-2D3	-2D3N	-2D3E	-2D3EN	-2D3H	-2D3HN
M2.5	0.45	-2D5	-2D5N	-2D5E	-2D5EN	-2D5H	-2D5HN
M2.6	0.45	-2D6	-2D6N	-2D6E	-2D6EN	-2D6H	-2D6HN
M3	0.5	-3	-3N	-3E	-3EN	-3H	-3HN
M3.5	0.6	-3D5	-3D5N	-3D5E	-3D5EN	-3D5H	-3D5HN
M4	0.7	-4	-4N	-4E	-4EN	-4H	-4HN
M4.5	0.75	-4D5	-4D5N	-4D5E	-4D5EN	-4D5H	-4D5HN
M5	0.8	-5	-5N	-5E	-5EN	-5H	-5HN
M6	1	-6	-6N	-6E	-6EN	-6H	-6HN
M7	1	-7	-7N	-7E	-7EN	-7H	-7HN
M8	1.25	-8	-8N	-8E	-8EN	-8H	-8HN
M9	1.25	-9	-9N	-9E	-9EN	-9H	-9HN
M10	1.5	-10	-10N	-10E	-10EN	-10H	-10HN
M11	1.5	-11	-11N	-11E	-11EN	-11H	-11HN
M12	1.75	-12	-12N	-12E	-12EN	-12H	-12HN
M14	2	-14	-14N	-14E	-14EN	-14H	-14HN
M16	2	-16	-16N	-16E	-16EN	-16H	-16HN
M18	2.5	-18	-18N	-18E	-18EN	-18H	-18HN
M20	2.5	-20	-20N	-20E	-20EN	-20H	-20HN
M22	2.5	-22	-22N	-22E	-22EN	-22H	-22HN
M24	3	-24	-24N	-24E	-24EN	-24H	-24HN
M27	3	-27	-27N	-27E	-27EN	-27H	-27HN
M30	3.5	-30	-30N	-30E	-30EN	-30H	-30HN
M33	3.5	-33	-33N	-33E	-33EN	-33H	-33HN
M36	4	-36	-36N	-36E	-36EN	-36H	-36HN
M39	4	-39	-39N	-39E	-39EN	-39H	-39HN
M42	4.5	-42	-42N	-42E	-42EN	-42H	-42HN
M45	4.5	-45	-45N	-45E	-45EN	-45H	-45HN
M48	5	-48	-48N	-48E	-48EN	-48H	-48HN
M52	5	-52	-52N	-52E	-52EN	-52H	-52HN
M56	5.5	-56	-56N	-56E	-56EN	-56H	-56HN
M60	5.5	-60	-60N	-60E	-60EN	-60H	-60HN
M64	6	-64	-64N	-64E	-64EN	-64H	-64HN
M68	6	-68	-68N	-68E	-68EN	-68H	-68HN

CHECK PLUGS FOR METRIC FINE THREAD RING GAGES

WARNING: LIFE TIME IS LIMITED,
CAN BE USED ABOUT 2000 TIMES



4677-10P

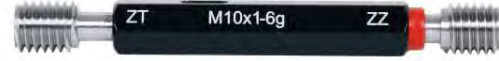

4677-10PN

- Standard ISO1502
- Check thread ring gages
- Supplied with manufacturer inspection certificate

Code example:
"-3D5G" stands for "4677-3D5G"

Size (mm)		Code (4677)					
		Class 6g		Class 6e		Class 6h	
Nominal diameter	Pitch	GO	NOGO	GO	NOGO	GO	NOGO
M3.5	0.5	-3D5G	-3D5GN	-3D5GE	-3D5GEN	-3D5GH	-3D5GHN
M4	0.5	-4G	-4GN	-4GE	-4GEN	-4GH	-4GHN
M4.5	0.5	-4D5G	-4D5GN	-4D5GE	-4D5GEN	-4D5GH	-4D5GHN
M5	0.5	-5G	-5GN	-5GE	-5GEN	-5GH	-5GHN
M5.5	0.5	-5D5G	-5D5GN	-5D5GE	-5D5GEN	-5D5GH	-5D5GHN
M6	0.5	-6G	-6GN	-6GE	-6GEN	-6GH	-6GHN
	0.75	-6L	-6LN	-6LE	-6LEN	-6LH	-6LHN
M6.5	0.5	-6D5G	-6D5GN	-6D5GE	-6D5GEN	-6D5GH	-6D5GHN
M7	0.5	-7G	-7GN	-7GE	-7GEN	-7GH	-7GHN
	0.75	-7L	-7LN	-7LE	-7LEN	-7LH	-7LHN
M7.5	0.5	-7D5G	-7D5GN	-7D5GE	-7D5GEN	-7D5GH	-7D5GHN
M8	0.5	-8G	-8GN	-8GE	-8GEN	-8GH	-8GHN
	0.75	-8L	-8LN	-8LE	-8LEN	-8LH	-8LHN
	1	-8P	-8PN	-8PE	-8PEN	-8PH	-8PHN
M8.5	0.5	-8D5G	-8D5GN	-8D5GE	-8D5GEN	-8D5GH	-8D5GHN
M9	0.5	-9G	-9GN	-9GE	-9GEN	-9GH	-9GHN
	0.75	-9L	-9LN	-9LE	-9LEN	-9LH	-9LHN
	1	-9P	-9PN	-9PE	-9PEN	-9PH	-9PHN
M10	0.5	-10G	-10GN	-10GE	-10GEN	-10GH	-10GHN
	0.75	-10L	-10LN	-10LE	-10LEN	-10LH	-10LHN
	1	-10P	-10PN	-10PE	-10PEN	-10PH	-10PHN
	1.25	-10Q	-10QN	-10QE	-10QEN	-10QH	-10QHN
M11	0.5	-11G	-11GN	-11GE	-11GEN	-11GH	-11GHN
	0.75	-11L	-11LN	-11LE	-11LEN	-11LH	-11LHN
	1	-11P	-11PN	-11PE	-11PEN	-11PH	-11PHN
M12	0.5	-12G	-12GN	-12GE	-12GEN	-12GH	-12GHN
	0.75	-12L	-12LN	-12LE	-12LEN	-12LH	-12LHN
	1	-12P	-12PN	-12PE	-12PEN	-12PH	-12PHN
	1.25	-12Q	-12QN	-12QE	-12QEN	-12QH	-12QHN
	1.5	-12R	-12RN	-12RE	-12REN	-12RH	-12RHN
M13	0.5	-13G	-13GN	-13GE	-13GEN	-13GH	-13GHN
	0.75	-13L	-13LN	-13LE	-13LEN	-13LH	-13LHN
	1	-13P	-13PN	-13PE	-13PEN	-13PH	-13PHN
	1.5	-13R	-13RN	-13RE	-13REN	-13RH	-13RHN
M14	0.5	-14G	-14GN	-14GE	-14GEN	-14GH	-14GHN
	0.75	-14L	-14LN	-14LE	-14LEN	-14LH	-14LHN
	1	-14P	-14PN	-14PE	-14PEN	-14PH	-14PHN
	1.25	-14Q	-14QN	-14QE	-14QEN	-14QH	-14QHN
	1.5	-14R	-14RN	-14RE	-14REN	-14RH	-14RHN

To be continued



Continued from previous page

Size (mm)		Code (4677)					
Nominal diameter	Pitch	Class 6g		Class 6e		Class 6h	
		GO	NOGO	GO	NOGO	GO	NOGO
M15	0.5	-15G	-15GN	-15GE	-15GEN	-15GH	-15GHN
	0.75	-15L	-15LN	-15LE	-15LEN	-15LH	-15LHN
	1	-15P	-15PN	-15PE	-15PEN	-15PH	-15PHN
	1.5	-15R	-15RN	-15RE	-15REN	-15RH	-15RHN
M16	0.5	-16G	-16GN	-16GE	-16GEN	-16GH	-16GHN
	0.75	-16L	-16LN	-16LE	-16LEN	-16LH	-16LHN
	1	-16P	-16PN	-16PE	-16PEN	-16PH	-16PHN
	1.25	-16Q	-16QN	-16QE	-16QEN	-16QH	-16QHN
	1.5	-16R	-16RN	-16RE	-16REN	-16RH	-16RHN
M17	0.5	-17G	-17GN	-17GE	-17GEN	-17GH	-17GHN
	0.75	-17L	-17LN	-17LE	-17LEN	-17LH	-17LHN
	1	-17P	-17PN	-17PE	-17PEN	-17PH	-17PHN
	1.5	-17R	-17RN	-17RE	-17REN	-17RH	-17RHN
M18	0.5	-18G	-18GN	-18GE	-18GEN	-18GH	-18GHN
	0.75	-18L	-18LN	-18LE	-18LEN	-18LH	-18LHN
	1	-18P	-18PN	-18PE	-18PEN	-18PH	-18PHN
	1.25	-18Q	-18QN	-18QE	-18QEN	-18QH	-18QHN
	1.5	-18R	-18RN	-18RE	-18REN	-18RH	-18RHN
	2	-18T	-18TN	-18TE	-18TEN	-18TH	-18THN
M19	0.5	-19G	-19GN	-19GE	-19GEN	-19GH	-19GHN
	0.75	-19L	-19LN	-19LE	-19LEN	-19LH	-19LHN
	1	-19P	-19PN	-19PE	-19PEN	-19PH	-19PHN
	1.5	-19R	-19RN	-19RE	-19REN	-19RH	-19RHN
M20	0.5	-20G	-20GN	-20GE	-20GEN	-20GH	-20GHN
	0.75	-20L	-20LN	-20LE	-20LEN	-20LH	-20LHN
	1	-20P	-20PN	-20PE	-20PEN	-20PH	-20PHN
	1.25	-20Q	-20QN	-20QE	-20QEN	-20QH	-20QHN
	1.5	-20R	-20RN	-20RE	-20REN	-20RH	-20RHN
	2	-20T	-20TN	-20TE	-20TEN	-20TH	-20THN
M21	0.75	-21L	-21LN	-21LE	-21LEN	-21LH	-21LHN
	1	-21P	-21PN	-21PE	-21PEN	-21PH	-21PHN
	1.5	-21R	-21RN	-21RE	-21REN	-21RH	-21RHN
M22	0.75	-22L	-22LN	-22LE	-22LEN	-22LH	-22LHN
	1	-22P	-22PN	-22PE	-22PEN	-22PH	-22PHN
	1.25	-22Q	-22QN	-22QE	-22QEN	-22QH	-22QHN
	1.5	-22R	-22RN	-22RE	-22REN	-22RH	-22RHN
	2	-22T	-22TN	-22TE	-22TEN	-22TH	-22THN
M23	0.75	-23L	-23LN	-23LE	-23LEN	-23LH	-23LHN
	1	-23P	-23PN	-23PE	-23PEN	-23PH	-23PHN
M24	0.75	-24L	-24LN	-24LE	-24LEN	-24LH	-24LHN
	1	-24P	-24PN	-24PE	-24PEN	-24PH	-24PHN
	1.25	-24Q	-24QN	-24QE	-24QEN	-24QH	-24QHN
	1.5	-24R	-24RN	-24RE	-24REN	-24RH	-24RHN
	2	-24T	-24TN	-24TE	-24TEN	-24TH	-24THN
M25	0.75	-25L	-25LN	-25LE	-25LEN	-25LH	-25LHN
	1	-25P	-25PN	-25PE	-25PEN	-25PH	-25PHN
	1.5	-25R	-25RN	-25RE	-25REN	-25RH	-25RHN
	2	-25T	-25TN	-25TE	-25TEN	-25TH	-25THN
M26	0.75	-26L	-26LN	-26LE	-26LEN	-26LH	-26LHN
	1	-26P	-26PN	-26PE	-26PEN	-26PH	-26PHN
	1.5	-26R	-26RN	-26RE	-26REN	-26RH	-26RHN
	2	-26T	-26TN	-26TE	-26TEN	-26TH	-26THN

To be continued

Continued from previous page

Size (mm)		Code (4677)					
		Class 6g		Class 6e		Class 6h	
Nominal diameter	Pitch	GO	NOGO	GO	NOGO	GO	NOGO
M27	0.75	-27L	-27LN	-27LE	-27LEN	-27LH	-27LHN
	1	-27P	-27PN	-27PE	-27PEN	-27PH	-27PHN
	1.5	-27R	-27RN	-27RE	-27REN	-27RH	-27RHN
	2	-27T	-27TN	-27TE	-27TEN	-27TH	-27THN
M28	0.75	-28L	-28LN	-28LE	-28LEN	-28LH	-28LHN
	1	-28P	-28PN	-28PE	-28PEN	-28PH	-28PHN
	1.5	-28R	-28RN	-28RE	-28REN	-28RH	-28RHN
	2	-28T	-28TN	-28TE	-28TEN	-28TH	-28THN
M29	0.75	-29L	-29LN	-29LE	-29LEN	-29LH	-29LHN
	1	-29P	-29PN	-29PE	-29PEN	-29PH	-29PHN
M30	0.75	-30L	-30LN	-30LE	-30LEN	-30LH	-30LHN
	1	-30P	-30PN	-30PE	-30PEN	-30PH	-30PHN
	1.5	-30R	-30RN	-30RE	-30REN	-30RH	-30RHN
	2	-30T	-30TN	-30TE	-30TEN	-30TH	-30THN
	3	-30V	-30VN	-30VE	-30VEN	-30VH	-30VHN
M31	0.75	-31L	-31LN	-31LE	-31LEN	-31LH	-31LHN
M32	0.75	-32L	-32LN	-32LE	-32LEN	-32LH	-32LHN
	1	-32P	-32PN	-32PE	-32PEN	-32PH	-32PHN
	1.5	-32R	-32RN	-32RE	-32REN	-32RH	-32RHN
M33	2	-32T	-32TN	-32TE	-32TEN	-32TH	-32THN
	0.75	-33L	-33LN	-33LE	-33LEN	-33LH	-33LHN
	1	-33P	-33PN	-33PE	-33PEN	-33PH	-33PHN
	1.5	-33R	-33RN	-33RE	-33REN	-33RH	-33RHN
M34	2	-33T	-33TN	-33TE	-33TEN	-33TH	-33THN
	3	-33V	-33VN	-33VE	-33VEN	-33VH	-33VHN
	1	-34P	-34PN	-34PE	-34PEN	-34PH	-34PHN
M35	1.5	-34R	-34RN	-34RE	-34REN	-34RH	-34RHN
	2	-34T	-34TN	-34TE	-34TEN	-34TH	-34THN
M36	1	-35P	-35PN	-35PE	-35PEN	-35PH	-35PHN
	1.5	-35R	-35RN	-35RE	-35REN	-35RH	-35RHN
	2	-35T	-35TN	-35TE	-35TEN	-35TH	-35THN
M38	1	-36P	-36PN	-36PE	-36PEN	-36PH	-36PHN
	1.5	-36R	-36RN	-36RE	-36REN	-36RH	-36RHN
	2	-36T	-36TN	-36TE	-36TEN	-36TH	-36THN
	3	-36V	-36VN	-36VE	-36VEN	-36VH	-36VHN
M39	1	-38P	-38PN	-38PE	-38PEN	-38PH	-38PHN
	1.5	-38R	-38RN	-38RE	-38REN	-38RH	-38RHN
	2	-38T	-38TN	-38TE	-38TEN	-38TH	-38THN
M40	1	-39P	-39PN	-39PE	-39PEN	-39PH	-39PHN
	1.5	-39R	-39RN	-39RE	-39REN	-39RH	-39RHN
	2	-39T	-39TN	-39TE	-39TEN	-39TH	-39THN
M42	3	-39V	-39VN	-39VE	-39VEN	-39VH	-39VHN
	1.5	-40R	-40RN	-40RE	-40REN	-40RH	-40RHN
	2	-40T	-40TN	-40TE	-40TEN	-40TH	-40THN
M45	3	-40V	-40VN	-40VE	-40VEN	-40VH	-40VHN
	1.5	-42R	-42RN	-42RE	-42REN	-42RH	-42RHN
	2	-42T	-42TN	-42TE	-42TEN	-42TH	-42THN
M45	3	-42V	-42VN	-42VE	-42VEN	-42VH	-42VHN
	1.5	-45R	-45RN	-45RE	-45REN	-45RH	-45RHN
	2	-45T	-45TN	-45TE	-45TEN	-45TH	-45THN
	3	-45V	-45VN	-45VE	-45VEN	-45VH	-45VHN

To be continued



Continued from previous page

Size (mm)		Code (4677)					
		Class 6g		Class 6e		Class 6h	
Nominal diameter	Pitch	GO	NOGO	GO	NOGO	GO	NOGO
M48	1.5	-48R	-48RN	-48RE	-48REN	-48RH	-48RHN
	2	-48T	-48TN	-48TE	-48TEN	-48TH	-48THN
	3	-48V	-48VN	-48VE	-48VEN	-48VH	-48VHN
M50	1.5	-50R	-50RN	-50RE	-50REN	-50RH	-50RHN
	2	-50T	-50TN	-50TE	-50TEN	-50TH	-50THN
	3	-50V	-50VN	-50VE	-50VEN	-50VH	-50VHN
M52	1.5	-52R	-52RN	-52RE	-52REN	-52RH	-52RHN
	2	-52T	-52TN	-52TE	-52TEN	-52TH	-52THN
	3	-52V	-52VN	-52VE	-52VEN	-52VH	-52VHN
	4	-52X	-52XN	-52XE	-52XEN	-52XH	-52XHN
M55	1.5	-55R	-55RN	-55RE	-55REN	-55RH	-55RHN
	2	-55T	-55TN	-55TE	-55TEN	-55TH	-55THN
	3	-55V	-55VN	-55VE	-55VEN	-55VH	-55VHN
	4	-55X	-55XN	-55XE	-55XEN	-55XH	-55XHN
M56	1.5	-56R	-56RN	-56RE	-56REN	-56RH	-56RHN
	2	-56T	-56TN	-56TE	-56TEN	-56TH	-56THN
	3	-56V	-56VN	-56VE	-56VEN	-56VH	-56VHN
	4	-56X	-56XN	-56XE	-56XEN	-56XH	-56XHN
M58	1.5	-58R	-58RN	-58RE	-58REN	-58RH	-58RHN
	2	-58T	-58TN	-58TE	-58TEN	-58TH	-58THN
	3	-58V	-58VN	-58VE	-58VEN	-58VH	-58VHN
	4	-58X	-58XN	-58XE	-58XEN	-58XH	-58XHN
M60	1.5	-60R	-60RN	-60RE	-60REN	-60RH	-60RHN
	2	-60T	-60TN	-60TE	-60TEN	-60TH	-60THN
	3	-60V	-60VN	-60VE	-60VEN	-60VH	-60VHN
	4	-60X	-60XN	-60XE	-60XEN	-60XH	-60XHN
M62	1.5	-62R	-62RN	-62RE	-62REN	-62RH	-62RHN
	2	-62T	-62TN	-62TE	-62TEN	-62TH	-62THN
	3	-62V	-62VN	-62VE	-62VEN	-62VH	-62VHN
	4	-62X	-62XN	-62XE	-62XEN	-62XH	-62XHN
M64	1.5	-64R	-64RN	-64RE	-64REN	-64RH	-64RHN
	2	-64T	-64TN	-64TE	-64TEN	-64TH	-64THN
	3	-64V	-64VN	-64VE	-64VEN	-64VH	-64VHN
	4	-64X	-64XN	-64XE	-64XEN	-64XH	-64XHN
M65	1.5	-65R	-65RN	-65RE	-65REN	-65RH	-65RHN
	2	-65T	-65TN	-65TE	-65TEN	-65TH	-65THN
	3	-65V	-65VN	-65VE	-65VEN	-65VH	-65VHN
	4	-65X	-65XN	-65XE	-65XEN	-65XH	-65XHN
M68	1.5	-68R	-68RN	-68RE	-68REN	-68RH	-68RHN
	2	-68T	-68TN	-68TE	-68TEN	-68TH	-68THN
	3	-68V	-68VN	-68VE	-68VEN	-68VH	-68VHN
	4	-68X	-68XN	-68XE	-68XEN	-68XH	-68XHN
M70	1.5	-70R	-70RN	-70RE	-70REN	-70RH	-70RHN
	2	-70T	-70TN	-70TE	-70TEN	-70TH	-70THN
	3	-70V	-70VN	-70VE	-70VEN	-70VH	-70VHN
	4	-70X	-70XN	-70XE	-70XEN	-70XH	-70XHN
	6	-70O	-70ON	-70OE	-70OEN	-70OH	-70OHN
M72	1.5	-72R	-72RN	-72RE	-72REN	-72RH	-72RHN
	2	-72T	-72TN	-72TE	-72TEN	-72TH	-72THN
	3	-72V	-72VN	-72VE	-72VEN	-72VH	-72VHN

To be continued

Continued from previous page

Size (mm)		Code (4677)					
		Class 6g		Class 6e		Class 6h	
Nominal diameter	Pitch	GO	NOGO	GO	NOGO	GO	NOGO
M72	4	-72X	-72XN	-72XE	-72XEN	-72XH	-72XHN
	6	-72O	-72ON	-72OE	-72OEN	-72OH	-72OHN
M75	1.5	-75R	-75RN	-75RE	-75REN	-75RH	-75RHN
	2	-75T	-75TN	-75TE	-75TEN	-75TH	-75THN
	3	-75V	-75VN	-75VE	-75VEN	-75VH	-75VHN
	4	-75X	-75XN	-75XE	-75XEN	-75XH	-75XHN
M76	1.5	-76R	-76RN	-76RE	-76REN	-76RH	-76RHN
	2	-76T	-76TN	-76TE	-76TEN	-76TH	-76THN
	3	-76V	-76VN	-76VE	-76VEN	-76VH	-76VHN
	4	-76X	-76XN	-76XE	-76XEN	-76XH	-76XHN
M78	6	-76O	-76ON	-76OE	-76OEN	-76OH	-76OHN
	2	-78T	-78TN	-78TE	-78TEN	-78TH	-78THN
M80	1.5	-80R	-80RN	-80RE	-80REN	-80RH	-80RHN
	2	-80T	-80TN	-80TE	-80TEN	-80TH	-80THN
	3	-80V	-80VN	-80VE	-80VEN	-80VH	-80VHN
	4	-80X	-80XN	-80XE	-80XEN	-80XH	-80XHN
M82	6	-80O	-80ON	-80OE	-80OEN	-80OH	-80OHN
	2	-82T	-82TN	-82TE	-82TEN	-82TH	-82THN
M85	2	-85T	-85TN	-85TE	-85TEN	-85TH	-85THN
	3	-85V	-85VN	-85VE	-85VEN	-85VH	-85VHN
	4	-85X	-85XN	-85XE	-85XEN	-85XH	-85XHN
M90	6	-85O	-85ON	-85OE	-85OEN	-85OH	-85OHN
	2	-90T	-90TN	-90TE	-90TEN	-90TH	-90THN
	3	-90V	-90VN	-90VE	-90VEN	-90VH	-90VHN
M95	4	-90X	-90XN	-90XE	-90XEN	-90XH	-90XHN
	6	-90O	-90ON	-90OE	-90OEN	-90OH	-90OHN
	2	-95T	-95TN	-95TE	-95TEN	-95TH	-95THN
M100	3	-95V	-95VN	-95VE	-95VEN	-95VH	-95VHN
	4	-95X	-95XN	-95XE	-95XEN	-95XH	-95XHN
	6	-95O	-95ON	-95OE	-95OEN	-95OH	-95OHN
M105	2	-100T	-100TN	-100TE	-100TEN	-100TH	-100THN
	3	-100V	-100VN	-100VE	-100VEN	-100VH	-100VHN
	4	-100X	-100XN	-100XE	-100XEN	-100XH	-100XHN
	6	-100O	-100ON	-100OE	-100OEN	-100OH	-100OHN
M110	2	-105T	-105TN	-105TE	-105TEN	-105TH	-105THN
	3	-105V	-105VN	-105VE	-105VEN	-105VH	-105VHN
	4	-105X	-105XN	-105XE	-105XEN	-105XH	-105XHN
M115	6	-105O	-105ON	-105OE	-105OEN	-105OH	-105OHN
	2	-110T	-110TN	-110TE	-110TEN	-110TH	-110THN
	3	-110V	-110VN	-110VE	-110VEN	-110VH	-110VHN
M120	4	-110X	-110XN	-110XE	-110XEN	-110XH	-110XHN
	6	-110O	-110ON	-110OE	-110OEN	-110OH	-110OHN
	2	-115T	-115TN	-115TE	-115TEN	-115TH	-115THN
M115	3	-115V	-115VN	-115VE	-115VEN	-115VH	-115VHN
	4	-115X	-115XN	-115XE	-115XEN	-115XH	-115XHN
	6	-115O	-115ON	-115OE	-115OEN	-115OH	-115OHN
M120	2	-120T	-120TN	-120TE	-120TEN	-120TH	-120THN
	3	-120V	-120VN	-120VE	-120VEN	-120VH	-120VHN
	4	-120X	-120XN	-120XE	-120XEN	-120XH	-120XHN
	6	-120O	-120ON	-120OE	-120OEN	-120OH	-120OHN

THREAD GAGES FOR ROTARY SHOULDERS CONNECTIONS OF PETROLEUM EQUIPMENT



- Measure the thread of rotary shouldered connections

4177-23

Number style gages

Code	Gage code	Form of thread to be inspected	Number of thread per inch	Taper	Angle of thread	Basic pitch dia
4177-10	NC10	V-0.055	6	1:8	60°	27.000mm
4177-12	NC12	V-0.055	6	1:8	60°	32.121mm
4177-13	NC13	V-0.055	6	1:8	60°	35.331mm
4177-16	NC16	V-0.055	6	1:8	60°	40.869mm
4177-23	NC23	V-0.038R	4	1:6	60°	59.817mm
4177-26	NC26	V-0.038R	4	1:6	60°	67.767mm
4177-31	NC31	V-0.038R	4	1:6	60°	80.848mm
4177-35	NC35	V-0.038R	4	1:6	60°	89.687mm
4177-38	NC38	V-0.038R	4	1:6	60°	96.723mm
4177-40	NC40	V-0.038R	4	1:6	60°	103.429mm
4177-44	NC44	V-0.038R	4	1:6	60°	112.192mm
4177-46	NC46	V-0.038R	4	1:6	60°	117.500mm
4177-50	NC50	V-0.038R	4	1:6	60°	128.059mm
4177-56	NC56	V-0.038R	4	1:4	60°	142.646mm
4177-61	NC61	V-0.038R	4	1:4	60°	156.921mm
4177-70	NC70	V-0.038R	4	1:4	60°	179.146mm
4177-77	NC77	V-0.038R	4	1:4	60°	196.621mm

Regular style gages

Code	Gage code	Form of thread to be inspected	Number of thread per inch	Taper	Angle of thread	Basic pitch dia
4177-2R	2 3/8 REG	V-0.040	5	1:4	60°	60.080mm
4177-21R	2 7/8 REG	V-0.040	5	1:4	60°	69.605mm
4177-3R	3 1/2 REG	V-0.040	5	1:4	60°	82.293mm
4177-4R	4 1/2 REG	V-0.040	5	1:4	60°	110.868mm
4177-5R	5 1/2 REG	V-0.050	4	1:4	60°	132.944mm
4177-6R	6 5/8 REG	V-0.050	4	1:6	60°	146.248mm
4177-7R	7 5/8 REG	V-0.050	4	1:4	60°	170.549mm
4177-8R	8 5/8 REG	V-0.050	4	1:4	60°	194.731mm

Full-hole style gages

Code	Gage code	Form of thread to be inspected	Number of thread per inch	Taper	Angle of thread	Basic pitch dia
4177-3H	3 1/2 FH	V-0.040	5	1:4	60°	94.844mm
4177-4H	4 1/2 FH	V-0.040	5	1:4	60°	115.113mm
4177-5H	5 1/2 FH	V-0.050	4	1:6	60°	142.011mm
4177-6H	6 5/8 FH	V-0.050	4	1:6	60°	165.598mm

Internal-flush style gage

Code	Gage code	Form of thread to be inspected	Number of thread per inch	Taper	Angle of thread	Basic pitch dia
4177-5F	5 1/2 IF	V-0.065	4	1:6	60°	157.201mm

CASING, TUBING AND LINE PIPE THREAD GAGES OF PETROLEUM AND GAS EQUIPMENT

API PRODUCTION LICENSE



■ Measure the casing, tubing and line pipe threads

4178-21T

Casing round thread gages

Code	Gage code	Outer dia	Number of thread per inch	Taper	Angle of thread
4178-4	4 1/2 CSG	114.30mm	8	1:16	60°
4178-4L	4 1/2 LCSG				
4178-5	5 CSG	127.00mm	8	1:16	60°
4178-5L	5 LCSG				
4178-51	5 1/2 CSG	139.70mm	8	1:16	60°
4178-51L	5 1/2 LCSG				
4178-6	6 5/8 CSG	168.28mm	8	1:16	60°
4178-6L	6 5/8 LCSG				
4178-7	7 CSG	177.80mm	8	1:16	60°
4178-7L	7 LCSG				
4178-71	7 5/8 CSG	193.68mm	8	1:16	60°
4178-71L	7 5/8 LCSG				
4178-8	8 5/8 CSG	219.08mm	8	1:16	60°
4178-8L	8 5/8 LCSG				
4178-9	9 5/8 CSG	244.48mm	8	1:16	60°
4178-9L	9 5/8 LCSG				
4178-10	10 3/4 CSG	273.05mm	8	1:16	60°
4178-10L	10 3/4 LCSG				
4178-11	11 3/4 CSG	298.45mm	8	1:16	60°
4178-11L	11 3/4 LCSG				
4178-13	13 3/8 CSG	339.73mm	8	1:16	60°
4178-13L	13 3/8 LCSG				
4178-16	16 CSG	406.40mm	8	1:16	60°
4178-16L	16 LCSG				

Non-upset tubing thread gages

Code	Gage code	Outer dia	Number of thread per inch	Taper	Angle of thread
4178-11T	1.050 TBG	26.67mm	10	1:16	60°
4178-13T	1.315 TBG	33.40mm	10	1:16	60°
4178-16T	1.660 TBG	42.16mm	10	1:16	60°
4178-19T	1.900 TBG	48.26mm	10	1:16	60°
4178-2T	2 3/8 TBG	60.33mm	10	1:16	60°
4178-21T	2 7/8 TBG	73.03mm	10	1:16	60°
4178-3T	3 1/2 TBG	88.90mm	10	1:16	60°
4178-4T	4 TBG	101.60mm	8	1:16	60°
4178-41T	4 1/2 TBG	114.30mm	8	1:16	60°

To be continued



Continued from previous page

External-upset tubing thread gages

Code	Gage code	Outer dia	Number of thread per inch	Taper	Angle of thread
4178-11U	1.050 UP TBG	26.67mm	10	1:16	60°
4178-13U	1.315 UP TBG	33.40mm	10	1:16	60°
4178-16U	1.660 UP TBG	42.16mm	10	1:16	60°
4178-19U	1.900 UP TBG	48.26mm	10	1:16	60°
4178-2U	2 3/8 UP TBG	60.33mm	8	1:16	60°
4178-21U	2 7/8 UP TBG	73.03mm	8	1:16	60°
4178-3U	3 1/2 UP TBG	88.90mm	8	1:16	60°
4178-4U	4 UP TBG	101.60mm	8	1:16	60°
4178-41U	4 1/2 UP TBG	114.30mm	8	1:16	60°

Buttress casing thread gages

Code	Gage code	Outer dia	Number of thread per inch	Taper	Angle of thread
4178-4B	4 1/2 BCSG	114.30mm	5	1:16	3°, 10°
4178-5B	5 BCSG	127.00mm	5	1:16	3°, 10°
4178-51B	5 1/2 BCSG	139.70mm	5	1:16	3°, 10°
4178-6B	6 5/8 BCSG	168.28mm	5	1:16	3°, 10°
4178-7B	7 BCSG	177.80mm	5	1:16	3°, 10°
4178-71B	7 5/8 BCSG	193.68mm	5	1:16	3°, 10°
4178-8B	8 5/8 BCSG	219.08mm	5	1:16	3°, 10°
4178-9B	9 5/8 BCSG	244.48mm	5	1:16	3°, 10°
4178-10B	10 3/4 BCSG	273.05mm	5	1:16	3°, 10°
4178-11B	11 3/4 BCSG	298.45mm	5	1:16	3°, 10°
4178-13B	13 3/8 BCSG	339.73mm	5	1:16	3°, 10°
4178-16B	16 BCSG	406.40mm	5	1:12	3°, 10°

Line pipe thread gages

Code	Gage code	Outer dia	Number of thread per inch	Taper	Angle of thread
4178-01P	1/8 LP	3.18mm	27	1:16	60°
4178-02P	1/4 LP	6.35mm	18	1:16	60°
4178-03P	3/8 LP	9.53mm	18	1:16	60°
4178-05P	1/2 LP	12.70mm	14	1:16	60°
4178-07P	3/4 LP	19.05mm	14	1:16	60°
4178-10P	1 LP	25.40mm	11 1/2	1:16	60°
4178-12P	1 1/4 LP	31.75mm	11 1/2	1:16	60°
4178-15P	1 1/2 LP	38.10mm	11 1/2	1:16	60°
4178-20P	2 LP	50.80mm	11 1/2	1:16	60°
4178-25P	2 1/2 LP	63.50mm	8	1:16	60°
4178-30P	3 LP	76.20mm	8	1:16	60°
4178-35P	3 1/2 LP	88.90mm	8	1:16	60°
4178-40P	4 LP	101.60mm	8	1:16	60°
4178-50P	5 LP	127.00mm	8	1:16	60°
4178-60P	6 LP	152.40mm	8	1:16	60°
4178-80P	8 LP	203.20mm	8	1:16	60°
4178-100P	10 LP	254.00mm	8	1:16	60°

14

ANGLE, STRAIGHTNESS, FLATNESS MEASUREMENT



Angle Meters
Page 335-336



Digital Levels And Slope Meters
Page 336



Protractors
Page 337-340



Granite Squares
Page 340-341



Cylinder Squares
Page 341



Perpendicularity Testers
Page 342



Squares
Page 342-348



Straight Edges
Page 348



Straight Edges
Page 349-350



Optical Flats
Page 350



Straightness/Flatness Gages
Page 351



- Clockwise and counter-clockwise operation
- 9 target angle values can be set, with audible and visible alarm:
 - Green LED light on and buzzer sounds when angle value is 80%~99.5% of target angle
 - Both green and red LED light on and buzzer sounds when angle value is over 99.5% of target angle
- Memory of 250 results, can upload to the computer
- Back with magnet
- Power off in 2 minutes automatically

SPECIFICATION

Display range	0~999°
Setting range	1~360° (increment 1°)
Resolution	0.1°
Accuracy	±2° for 90° rotation @30°/sec
Power supply	2×1.5V AAA batteries
Dimension	58×58×41mm
Weight	70g



- AUTOMATIC BACKLIGHT**
- ABSOLUTE LEVEL**
- IP54 WATERPROOF**

WATERPROOF DIGITAL PROTRACTOR (HEAVY DUTY)

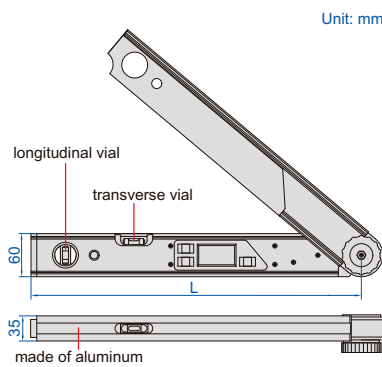

2174-225

- Suitable for setting horizontal and vertical mitre angles of cutting machines
- Buttons: ON/OFF, HOLD/SUP, SPR/CNR/MTR/BVL
- IP54 dust/waterproof
- With transverse and longitudinal vials
- 2xAAA batteries
- Absolute level, zero setting is not needed when batteries are replaced
- Backlight turns off in one minute after reading is stable, automatic power off in 5 minutes

Code	Size (L)	Range	Resolution	Accuracy
2174-225	460mm	0-225°	0.05°	±0.10°

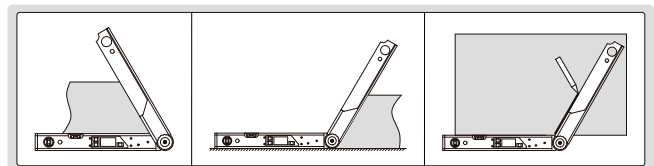

DIGITAL PROTRACTOR

- Buttons: on/off, hold (keep the reading), zero, ABS (absolute and incremental measurement)
- Fix the locking screw at 4 positions for different measuring ranges: 0°~225°, -225°~0°, -45°~180°, -180°~45°
- Remove the locking screw for 360° range
- With level vial
- Battery CR2032, automatic power off



2171-250

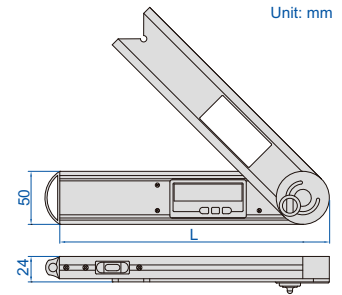

Unit: mm

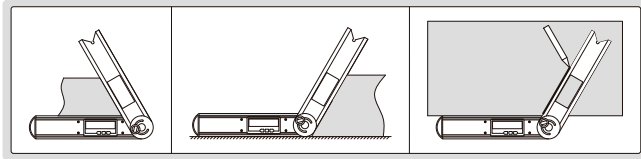

Code	Size (L)	Range	Resolution	Accuracy
2171-250	250mm	0-360°	0.05°	±0.15°

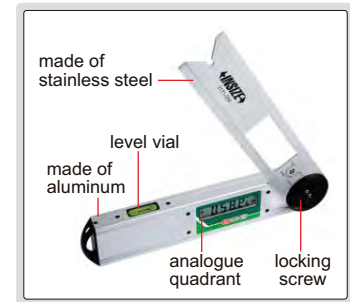

14

DIGITAL PROTRACTORS



2176-200

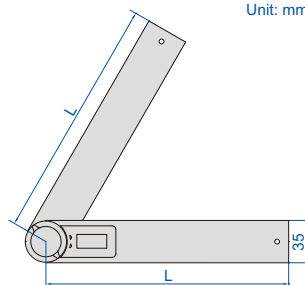

Unit: mm

- Buttons: on/off, zero
- With clamping screw to lock the blades
- Graduation of blade: 1mm and 1/32"
- Made of stainless steel
- CR2032 battery
- Automatic power off

Code	Size (L)	Range	Resolution	Accuracy
2176-200	200mm	0-360°	0.1°	±0.3°
2176-300	300mm	0-360°	0.1°	±0.3°

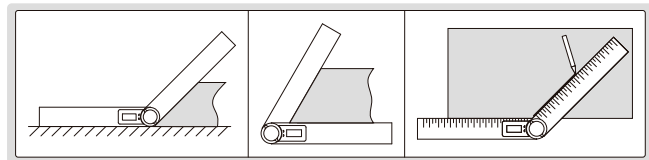

DIGITAL LEVELS AND SLOPE METERS

REFER TO PAGE 443-445 FOR DETAILS



2179-360



2175-360



2199-1



2170-1

PROTRACTOR (ECONOMIC TYPE)

- Graduation: 1°
- Made of stainless steel
- With clamping screw



4780-85A

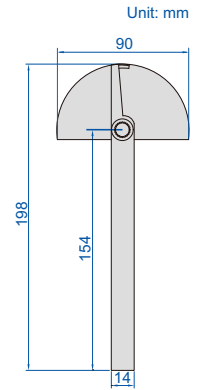

Code	Size	Range	Accuracy
4780-85A	90x154mm	0-180°	±0.5°

PROTRACTOR

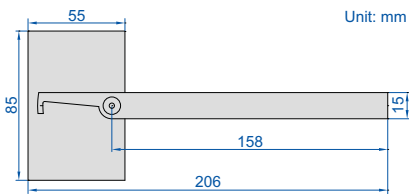

4781-85A

- Made of stainless steel
- Satin chrome plated scale
- With clamping screw

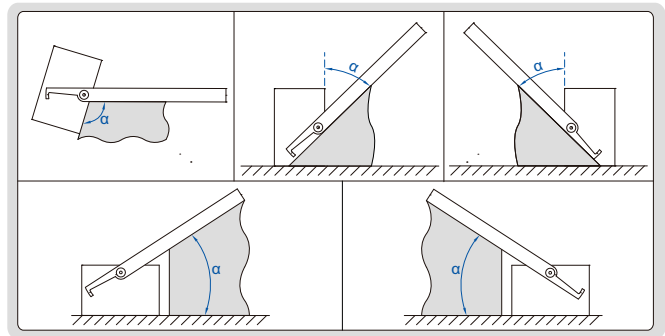

Code	Size	Range	Graduation	Accuracy
4781-85A	85x158mm	0-180°	1°	±0.3°

PROTRACTORS

- Graduation: 1°
- Made of stainless steel (4799-1300 is made of carbon steel)
- Satin chrome plated scale
- With clamping screw



4799-180

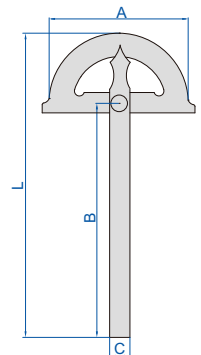

Code	Size (AxB)	Range	Accuracy	L	C
4799-180	80x120mm	0-180°	±0.3°	168mm	11mm
4799-1120	120x150mm	0-180°	±0.3°	220mm	14mm
4799-1150	150x200mm	0-180°	±0.3°	285mm	16mm
4799-1200	200x300mm	0-180°	±0.3°	413mm	20mm
4799-1300	300x500mm	0-180°	±0.3°	675mm	30mm

PROTRACTORS

- Graduation: 1°
- Made of carbon steel
- Satin chrome plated
- With clamping screw
- The blade is moveable



4797-100

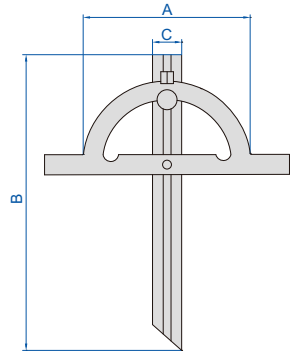

Code	Size (AxB)	Range	Accuracy	C
4797-100	100x150mm	10-170°	±0.3°	18mm
4797-150	150x300mm	10-170°	±0.3°	22mm
4797-200	200x400mm	10-170°	±0.3°	24mm
4797-250	250x500mm	10-170°	±0.3°	28mm
4797-300	300x600mm	10-170°	±0.3°	32mm

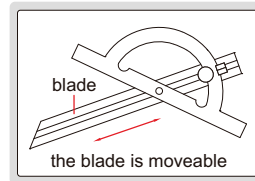

PROTRACTORS

14



2374-320

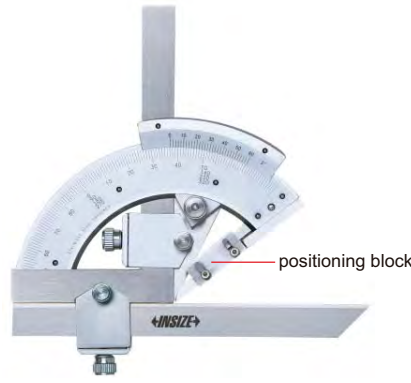

2374-320D

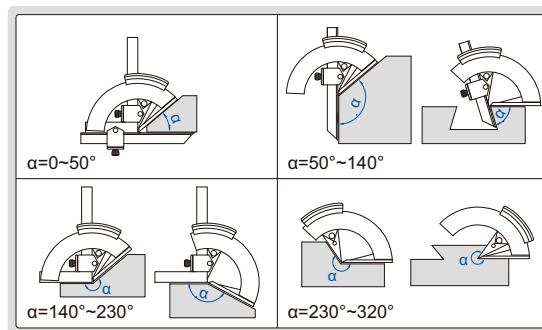
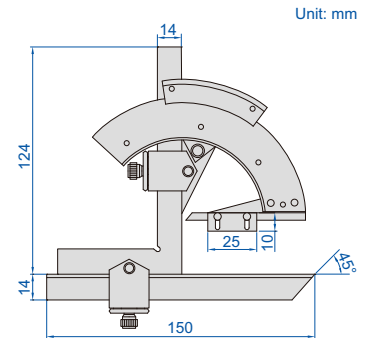

- Made of stainless steel
- Satin chrome plated scale

Code	Range	Graduation	Accuracy	Remark
2374-320	0-320°	2'	±2'	without positioning block
2374-320D	0-320°	2'	±2'	with positioning block

application of 2374-320D



the positioning block can be moved down for positioning, and moved up when not in use

UNIVERSAL PROTRACTOR

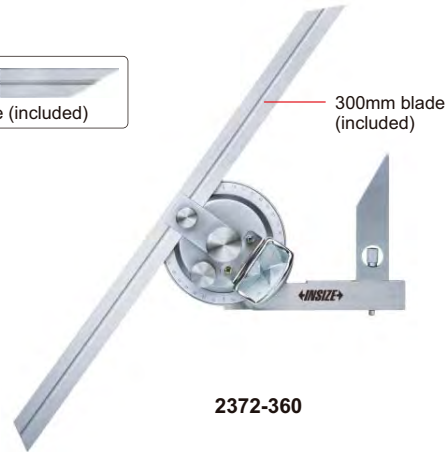
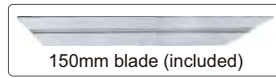
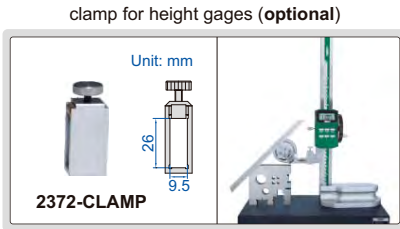

- Parallax-free reading
- Made of stainless steel
- Optional accessory: clamp (code 2372-CLAMP), suitable for height gages 1156, 1150-300, 1351, 1250 and 1151

Code	Range	Graduation	Accuracy
2372-360	0-360°	5'	±5'

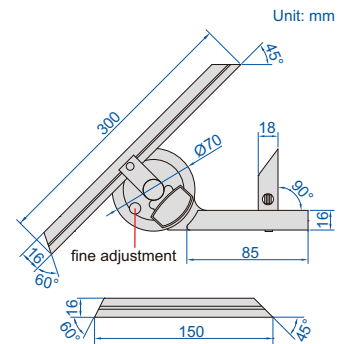

DIAL PROTRACTOR

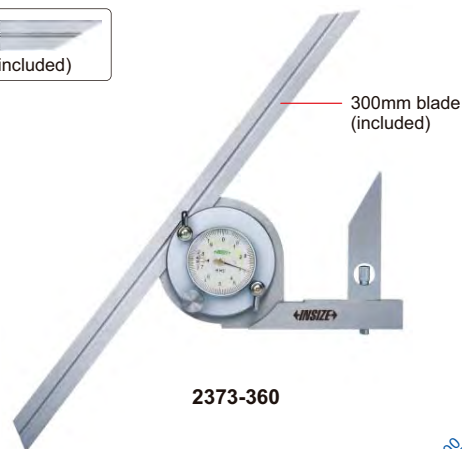
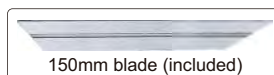
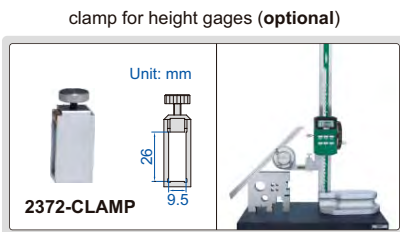

- Made of stainless steel
- Optional accessory: clamp (code 2372-CLAMP), suitable for height gages 1156, 1150-300, 1351, 1250 and 1151

Code	Range	Graduation	Accuracy
2373-360	0-360°	5'	±5'

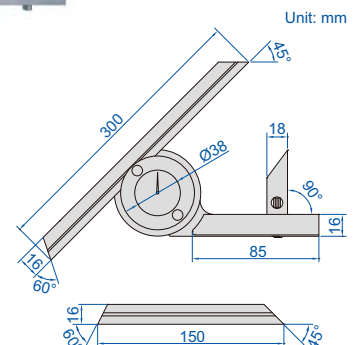

DIGITAL PROTRACTOR

DATA OUTPUT

ABSOLUTE ZERO

POPULAR MODEL

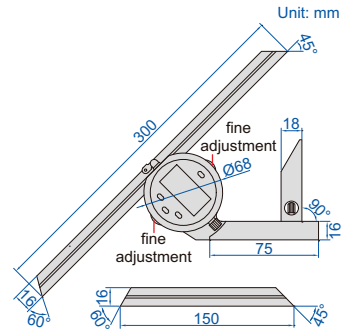
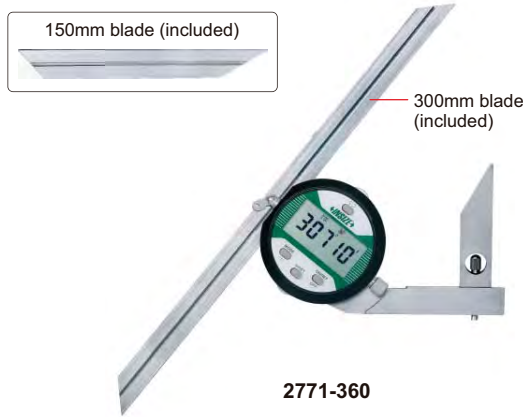

14

- Absolute zero, zero setting is not needed when batteries are replaced
- Button function: choose 0-90°, 0-180° or 0-360° display, change resolution, display flips over, data hold, zero, on/off supplementary angle measurement
- Battery CR2032, automatic power off, data output
- Made of stainless steel
- Optional square for zero setting
- Optional accessory: clamp (code **2372-CLAMP**), suitable for height gages **1156, 1150-300, 1351, 1250** and **1151**, data output cable (code **7315-2771** page 6, **7302-50M** page 13)

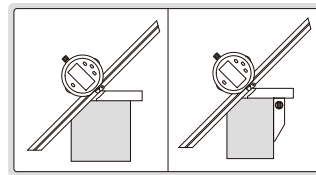

square (optional)



clamp for height gages (optional)

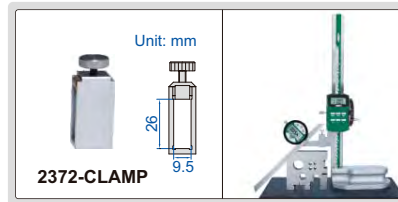

Square (for zero setting, optional)

Code
2771-S90

Code	Range	Resolution	Accuracy
2771-360	0-360°	1/0.01°	±5'

GRANITE SQUARE

CUSTOM-MADE
SUPPLY SPECIAL SIZES ACCORDING
TO CUSTOMER'S REQUEST



4144-315

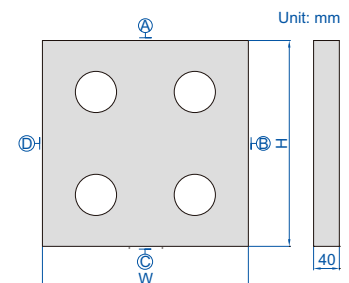

Code	Size (HxW)	Flatness of A, B, C and D	Squareness and parallelism between A, B, C and D
4144-315	315x315mm	1.1µm	2.6µm

CUSTOM-MADE
SUPPLY SPECIAL SIZES ACCORDING
TO CUSTOMER'S REQUEST

GRANITE SQUARES

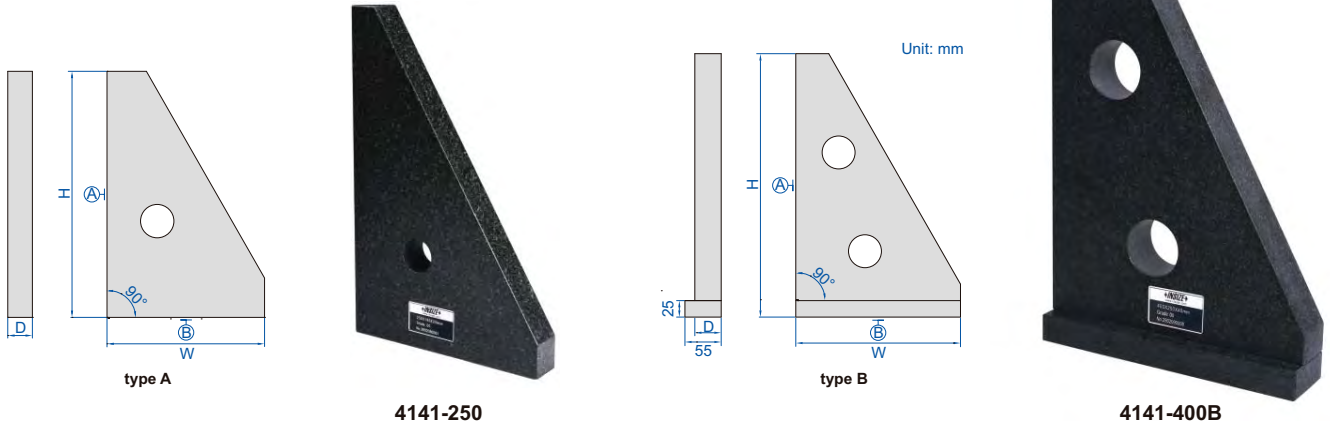

Code	Size (HxW)	Type	Flatness of A	Flatness of B	Squareness of A to B	D
4141-250	250x160mm	A	1µm	1µm	2µm	25mm
4141-400	400x250mm	A	1.5µm	1µm	3µm	40mm
4141-630	630x400mm	A	2µm	1.5µm	4µm	63mm
4141-400B	400x250mm	B	1.5µm	1µm	3µm	40mm



CYLINDER SQUARES

- Made of special alloy steel, hardness HRC58~60
- The handle can be removed

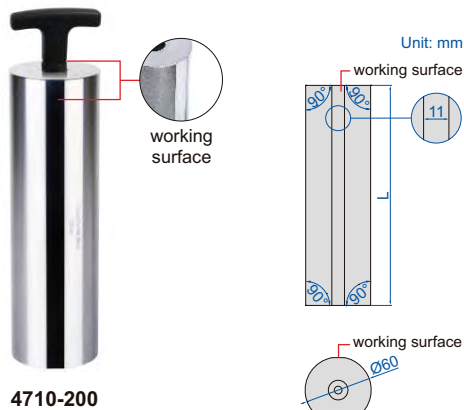

inspect 90° internal and external angles

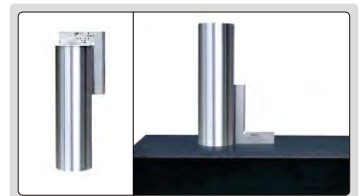

Code	Length (L)	Squareness
4710-200*	200mm	1µm
4710-300*	300mm	2µm

*Supplied with manufacturer inspection certificate

PERPENDICULARITY TESTERS

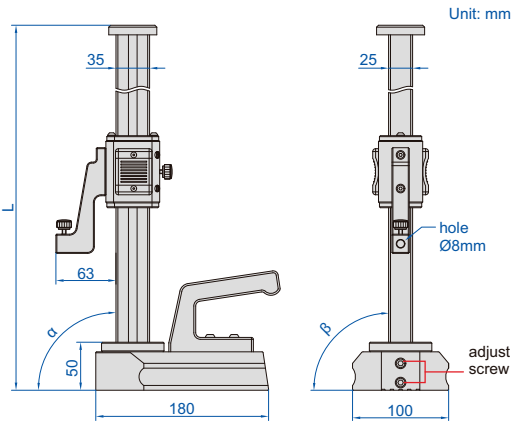

4770-300



14

- Optional accessory: dial test indicators (graduation: 1μm or 2μm)

Code	Range (H)	Perpendicularity (α)	Side perpendicularity (β)	L
4770-300	0-300mm	3μm	10μm	460mm
4770-600	0-600mm	5μm	20μm	760mm

90° BEVELED EDGE SQUARES

- Satin chrome plating
- Beveled edges for inside and outside measurements
- Made of hardened stainless steel



4790-0100

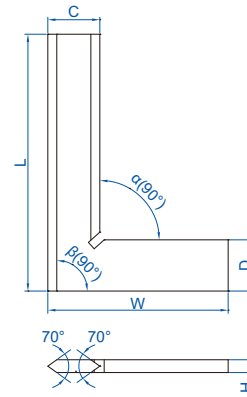

DIN875 grade 00		(mm)				
Code	Size (LxW)	Squareness		C	D	H
		Inside (α)	Outside (β)			
4790-050	50x40mm	2.4μm	2.5μm	13	13	4
4790-075	75x50mm	2.6μm	2.8μm	15	15	4
4790-0100	100x70mm	2.8μm	3.0μm	20	20	5
4790-0150	150x100mm	3.2μm	3.5μm	30	30	6
4790-0200	200x130mm	3.7μm	4.0μm	34	34	7
4790-0250	250x165mm	4.2μm	4.5μm	35	35	7
4790-0300	300x200mm	4.6μm	5.0μm	40	40	8

DIN875 grade 0		(mm)				
Code	Size (LxW)	Squareness		C	D	H
		Inside (α)	Outside (β)			
4790-500	50x40mm	6μm	6μm	13	13	4
4790-750	75x50mm	6μm	7μm	15	15	4
4790-1000	100x70mm	7μm	7μm	20	20	5
4790-1500	150x100mm	7μm	8μm	30	30	6
4790-2000	200x130mm	8μm	9μm	34	34	7
4790-2500	250x165mm	9μm	10μm	35	35	7
4790-3000	300x200mm	10μm	11μm	40	40	8

90° TOOL MAKER SQUARES

- DIN875 grade 00
- Beveled edge for inside measurement
- Made of hardened stainless steel

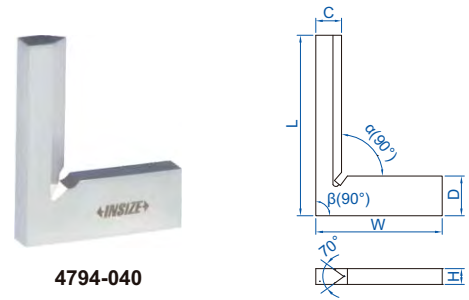

4794-040

(mm)

Code	Size (LxW)	Squareness		C	D	H
		Inside (α)	Outside (β)			
4794-025	25x20mm	2.2 μ m	2.3 μ m	4	6.5	3.5
4794-040	40x28mm	2.3 μ m	2.4 μ m	5.5	8.5	3.5

90° FLAT EDGE SQUARES

- Made of hardened stainless steel

DIN875 grade 0 (mm)

Code	Size (LxW)	Squareness		C	D	H
		Inside (α)	Outside (β)			
4791-50	50x40mm	6 μ m	6 μ m	15	15	4
4791-75	75x50mm	6 μ m	7 μ m	15	15	4
4791-100	100x70mm	7 μ m	7 μ m	20	20	5
4791-150	150x100mm	7 μ m	8 μ m	30	30	6
4791-200	200x130mm	8 μ m	9 μ m	30	30	7
4791-250	250x165mm	9 μ m	10 μ m	35	35	7
4791-300	300x200mm	10 μ m	11 μ m	40	40	8



4791-100

DIN875 grade 1 (mm)

Code	Size (LxW)	Squareness		C	D	H
		Inside (α)	Outside (β)			
4791-501	50x40mm	12 μ m	13 μ m	15	15	4
4791-751	75x50mm	13 μ m	14 μ m	15	15	4
4791-1001	100x70mm	14 μ m	15 μ m	20	20	5
4791-1501	150x100mm	16 μ m	18 μ m	30	30	6
4791-2001	200x130mm	19 μ m	20 μ m	30	30	7
4791-2501	250x165mm	21 μ m	23 μ m	35	35	7
4791-3001	300x200mm	23 μ m	25 μ m	40	40	8

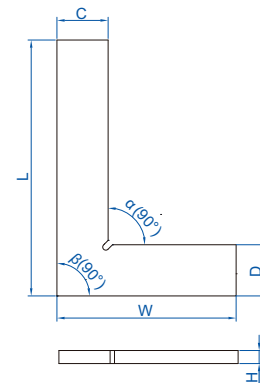

DIN875 grade 2 (mm)

Code	Size (LxW)	Squareness		C	D	H
		Inside (α)	Outside (β)			
4791-502	50x40mm	24 μ m	25 μ m	15	15	4
4791-752	75x50mm	26 μ m	28 μ m	15	15	4
4791-1002	100x70mm	28 μ m	30 μ m	20	20	5
4791-1502	150x100mm	33 μ m	35 μ m	30	30	6
4791-2002	200x130mm	38 μ m	40 μ m	30	30	7
4791-2502	250x165mm	43 μ m	45 μ m	35	35	7
4791-3002	300x200mm	47 μ m	50 μ m	40	40	8

MACHINIST SQUARES (ECONOMIC TYPE)

ATTENTION: NO ANTI-RUST TREATMENT, NOT HARDEND

ATTENTION: LOW ACCURACY

- DIN875 grade 2
- Made of carbon steel, no anti-rust treatment, not hardend

Code	Size (LxW)	Squareness		C	D	H	(mm)
		Inside (α)	Outside (β)				
4796-50	50x30mm	24 μ m	25 μ m	12	12	3	
4796-75	75x50mm	26 μ m	28 μ m	16	16	3	
4796-100	100x70mm	28 μ m	30 μ m	19	19	5	
4796-125	125x80mm	30 μ m	33 μ m	22	22	5	
4796-150	150x100mm	33 μ m	35 μ m	25	25	6	
4796-200	200x130mm	38 μ m	40 μ m	25	25	6	
4796-250	250x165mm	43 μ m	45 μ m	25	25	6	
4796-300	300x200mm	47 μ m	50 μ m	30	30	6	
4796-350	350x200mm	51 μ m	55 μ m	38	38	6	
4796-400	400x200mm	56 μ m	60 μ m	38	38	9	
4796-450	450x250mm	58 μ m	65 μ m	38	38	9	
4796-500	500x300mm	69 μ m	70 μ m	38	38	9	

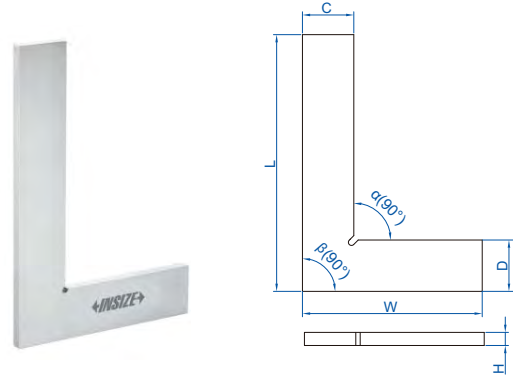

4796-150

14 90° FLAT EDGE SQUARES WITH WIDE BASE

- Made of hardened stainless steel

DIN875 grade 0 (mm)

Code	Size (LxW)	Squareness		C	D	H	E
		Inside (α)	Outside (β)				
4793-50	50x40mm	6 μ m	6 μ m	15	15	4	13
4793-75	75x50mm	6 μ m	7 μ m	15	15	4	15
4793-100	100x70mm	7 μ m	7 μ m	20	20	5	20
4793-150	150x100mm	7 μ m	8 μ m	30	30	6	30
4793-200	200x130mm	8 μ m	9 μ m	30	30	7	30
4793-250	250x165mm	9 μ m	10 μ m	35	35	7	35
4793-300	300x200mm	10 μ m	11 μ m	40	40	8	40



4793-100

DIN875 grade 1 (mm)

Code	Size (LxW)	Squareness		C	D	H	E
		Inside (α)	Outside (β)				
4793-501	50x40mm	12 μ m	13 μ m	15	15	4	13
4793-751	75x50mm	13 μ m	14 μ m	15	15	4	15
4793-1001	100x70mm	14 μ m	15 μ m	20	20	5	20
4793-1501	150x100mm	16 μ m	18 μ m	30	30	6	30
4793-2001	200x130mm	19 μ m	20 μ m	30	30	7	30
4793-2501	250x165mm	21 μ m	23 μ m	35	35	7	35
4793-3001	300x200mm	23 μ m	25 μ m	40	40	8	40

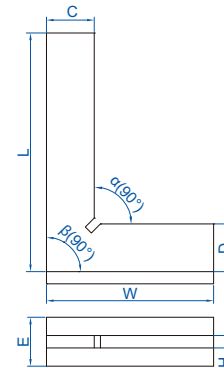

DIN875 grade 2 (mm)

Code	Size (LxW)	Squareness		C	D	H	E
		Inside (α)	Outside (β)				
4793-502	50x40mm	24 μ m	25 μ m	15	15	4	13
4793-752	75x50mm	26 μ m	28 μ m	15	15	4	15
4793-1002	100x70mm	28 μ m	30 μ m	20	20	5	20
4793-1502	150x100mm	33 μ m	35 μ m	30	30	6	30
4793-2002	200x130mm	38 μ m	40 μ m	30	30	7	30
4793-2502	250x165mm	43 μ m	45 μ m	35	35	7	35
4793-3002	300x200mm	47 μ m	50 μ m	40	40	8	40

90° FLAT EDGE SQUARES WITH WIDE BASE

- DIN875 grade 0
- Made of hardened stainless steel

Code	Size (LxW)	Squareness		C	D	H	E
		Inside (α)	Outside (β)				
4792-50	50x40mm	6 μ m	6 μ m	12	12	3	10
4792-75	75x50mm	6 μ m	7 μ m	14	14	3	10
4792-100	100x70mm	7 μ m	7 μ m	18	18	3	10
4792-150	150x100mm	8 μ m	8 μ m	22	22	4	12
4792-200	200x130mm	9 μ m	9 μ m	25	25	4	12

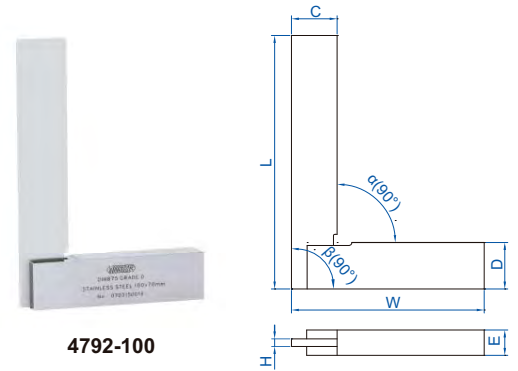

4792-100

ATTENTION: NO ANTI-RUST TREATMENT, NOT HARDEND

MACHINIST SQUARES WITH WIDE BASE (ECONOMIC TYPE)

- DIN875 grade 2
- Made of carbon steel, no anti-rust treatment, not hardend

Code	Size (LxW)	Squareness		C	D	H	E
		Inside (α)	Outside (β)				
4707-50	50x40mm	24 μ m	25 μ m	16	12	3	9
4707-75	75x50mm	26 μ m	28 μ m	16	16	3	9
4707-100	100x70mm	28 μ m	30 μ m	19	19	3	12
4707-150	150x100mm	33 μ m	35 μ m	25	25	3	16
4707-200	200x130mm	37 μ m	40 μ m	30	32	4	16
4707-250	250x165mm	42 μ m	45 μ m	30	32	4	19
4707-300	300x200mm	47 μ m	50 μ m	32	32	4	19
4707-400	400x250mm	56 μ m	60 μ m	38	38	5	22
4707-500	500x300mm	65 μ m	70 μ m	45	50	6	25
4707-600	600x350mm	75 μ m	80 μ m	50	50	6	30
4707-750	750x400mm	90 μ m	95 μ m	55	55	6	50
4707-900	900x500mm	103 μ m	110 μ m	65	75	9	50
4707-1000	1000x550mm	113 μ m	120 μ m	65	75	9	50



4707-100

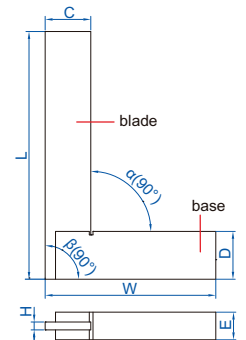

90° BEVELED EDGE SQUARES WITH WIDE BASE

- DIN875 grade 0
- Beveled edges for inside and outside measurements
- Made of hardened stainless steel

Code	Size (LxW)	Squareness		C	D	H	E
		Inside (α)	Outside (β)				
4795-50	50x40mm	6 μ m	6 μ m	12	12	3	10
4795-75	75x50mm	6 μ m	7 μ m	14	14	3	10
4795-100	100x70mm	7 μ m	7 μ m	18	18	3	10
4795-150	150x100mm	8 μ m	8 μ m	22	22	4	12
4795-200	200x130mm	9 μ m	9 μ m	25	25	4	12



4795-100

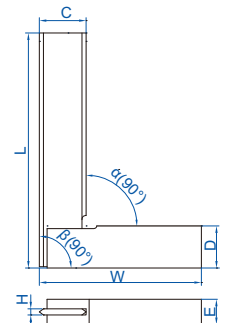

TRY SQUARE

- Graduation: 1mm
- Stainless steel blade, aluminum base

Code	Size (LxW)	Squareness	
		Inside (α)	Outside (β)
2275-300	300x170mm	0.5mm	0.5mm



2275-300

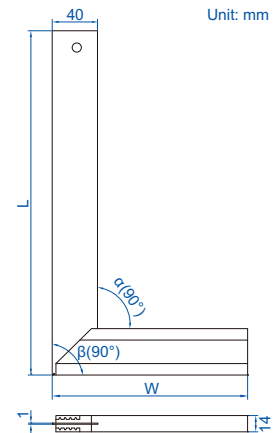

TRY SQUARE

14

- Graduation: 1mm
- Aluminum blade and base
- 4 milled surfaces
- Retractable metal ledge support
- Etchings and holes for beveling and framing: 10°, 15°, 22.5°, 30°, 45°, 50° and 60°
- Etchings and holes every cm for fluid pencil marking

Code	Size (LxW)	Squareness	
		Inside (α)	Outside (β)
2280-300	300x150mm	0.5mm	0.5mm



2280-300

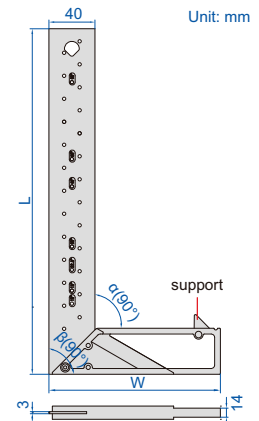

ADJUSTABLE SQUARE

- The straight edge can move and can be locked by the clamping screw
- Made of hardened stainless steel

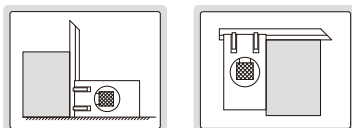

4701-1

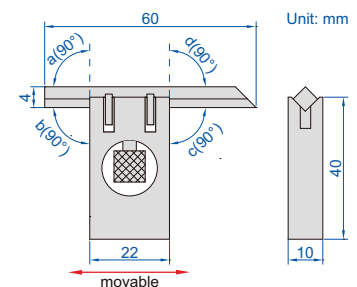

Code	Squareness (a, b, c, d)
4701-1	7µm



45° SQUARES

- Made of hardened stainless steel

Code	Size (LxW)	Accuracy		C	D	H
		Inside (α)	Outside (β)			
4745-1120	120x80mm	29 μ m	32 μ m	20	20	5
4745-1150	150x100mm	32 μ m	35 μ m	20	20	5
4745-1200	200x130mm	36 μ m	40 μ m	25	25	5



4745-1120

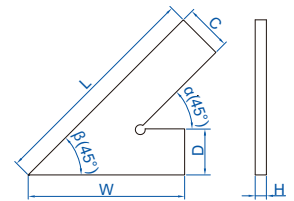

45° SQUARES WITH WIDE BASE

- Made of hardened stainless steel

Code	Size (LxW)	Accuracy		C	D	H	E
		Inside (α)	Outside (β)				
4747-120	120x80mm	29 μ m	33 μ m	20	20	5	20
4747-150	150x100mm	32 μ m	36 μ m	20	20	5	20
4747-200	200x130mm	36 μ m	41 μ m	25	25	5	25



4747-120

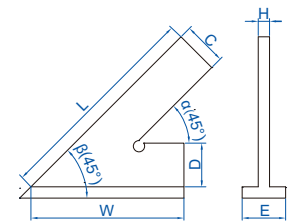

60° SQUARES

- Made of hardened stainless steel

Code	Size (LxW)	Accuracy		C	D	H
		Inside (α)	Outside (β)			
4760-1120	120x80mm	30 μ m	32 μ m	20	20	5
4760-1150	150x100mm	32 μ m	35 μ m	20	20	5
4760-1200	200x130mm	37 μ m	40 μ m	25	25	5



4760-1120

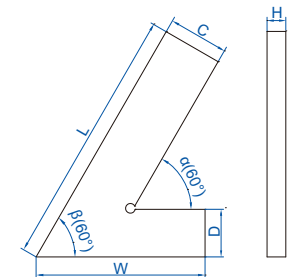

60° SQUARES WITH WIDE BASE

- Made of hardened stainless steel

Code	Size (LxW)	Accuracy		C	D	H	E
		Inside (α)	Outside (β)				
4762-120	120x80mm	30 μ m	33 μ m	20	20	5	20
4762-150	150x100mm	33 μ m	36 μ m	20	20	5	20
4762-200	200x130mm	37 μ m	41 μ m	25	25	5	25



4762-120

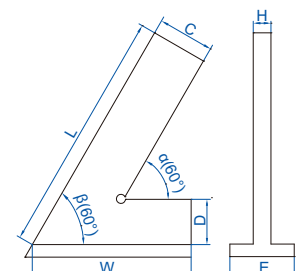

120° SQUARES

- Made of hardened stainless steel

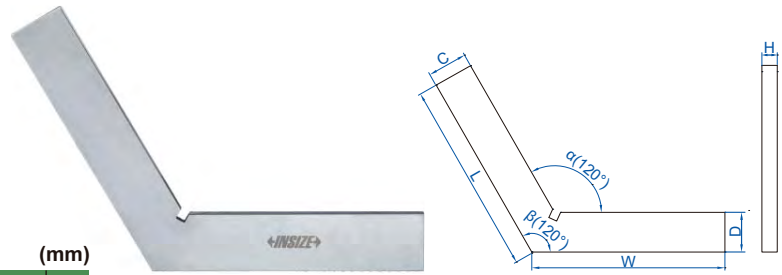

4706-1100

Code	Size (LxW)	Accuracy		C	D	H
		Inside (α)	Outside (β)			
4706-150	50x50mm	24 μ m	25 μ m	15	15	5
4706-175	75x75mm	26 μ m	28 μ m	20	20	5
4706-1100	100x100mm	29 μ m	30 μ m	20	20	5
4706-1150	150x150mm	34 μ m	35 μ m	25	25	5
4706-1200	200x200mm	38 μ m	40 μ m	30	30	7

135° SQUARES WITH WIDE BASE

- Made of hardened stainless steel

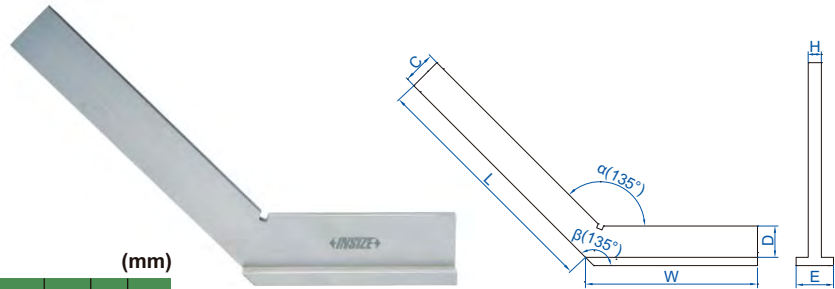

4754-3120

Code	Size (LxW)	Accuracy		C	D	H	E
		Inside (α)	Outside (β)				
4754-3120	120x80mm	31 μ m	33 μ m	20	20	5	20
4754-3150	150x100mm	34 μ m	36 μ m	20	20	5	20
4754-3200	200x130mm	39 μ m	41 μ m	30	30	7	30

STRAIGHT EDGES

- DIN874
- Beveled edge
- Made of hardened stainless steel
- Satin chrome plating

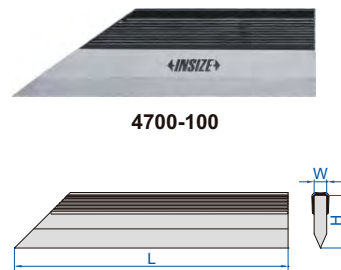

4700-100

Code	Size (L)	Straightness	W	H
4700-50	50mm	2.2 μ m	5mm	20mm
4700-75	75mm	2.3 μ m	5mm	25mm
4700-100	100mm	2.4 μ m	5mm	25mm
4700-125	125mm	2.5 μ m	6mm	30mm
4700-150	150mm	2.6 μ m	6mm	30mm
4700-200	200mm	2.8 μ m	6mm	30mm
4700-250	250mm	3.0 μ m	8mm	40mm
4700-300	300mm	3.2 μ m	8mm	40mm
4700-400	400mm	3.6 μ m	10mm	50mm
4700-500	500mm	4.0 μ m	10mm	50mm

SQUARE SET

- Includes:
 - 90° tool maker square 25x20mm DIN875 grade 00 (code **4794-025**)
 - 90° tool maker square 40x28mm DIN875 grade 00 (code **4794-040**)
 - 90° beveled edge square 75x50mm DIN875 grade 00 (code **4790-075**)
 - straight edge 100mm DIN874 (code **4700-100**)
 - scraper
- Made of hardened stainless steel

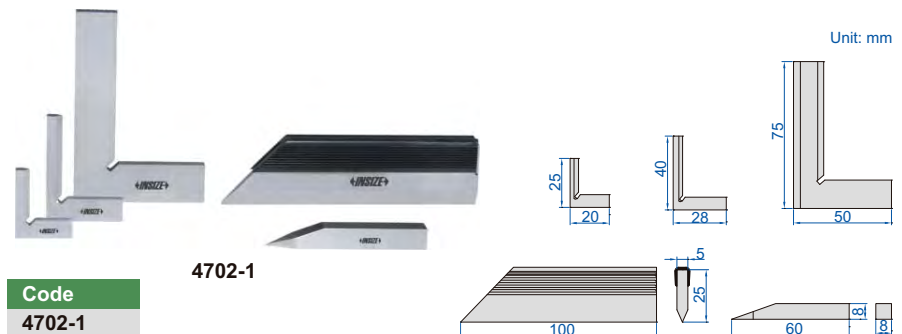

Code
4702-1

4702-1

GRANITE STRAIGHT EDGES

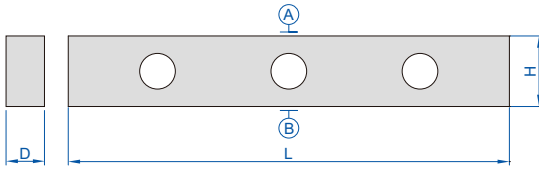

4147-500A

Code	Length (L)	Flatness of A and B	Parallelism between A and B	D	H
4147-500A	500mm	2.1 μ m	3.2 μ m	50mm	80mm
4147-1000A	1000mm	3.0 μ m	4.5 μ m	60mm	120mm

LIGHT WEIGHT

MAGNALIUM STRAIGHT EDGES

- Made of magnalium, light weight, non-deform, no rusty



4180-1500

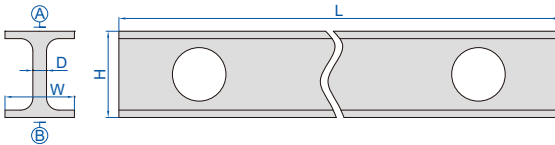

Code	Length (L)	Flatness of A and B	Parallelism between A and B	H	W	D	Weight
4180-500	500mm	3 μ m	4 μ m	60mm	30mm	5mm	1kg
4180-1000	1000mm	5 μ m	8 μ m	60mm	30mm	5mm	1.5kg
4180-1500	1500mm	15 μ m	22 μ m	100mm	40mm	7mm	4.5kg
4180-2000	2000mm	18 μ m	27 μ m	100mm	40mm	7mm	6kg
4180-2500	2500mm	22 μ m	33 μ m	100mm	40mm	7mm	7.5kg
4180-3000	3000mm	48 μ m	72 μ m	150mm	80mm	8mm	21kg

PRECISION STRAIGHT EDGES



7117-300

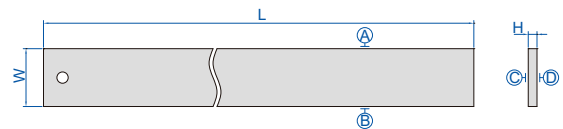

- Check flatness and for marking
- Made of tool steel

Code	Range (L)	Flatness of A and B	Flatness of C and D	W	H
7117-300	305mm	0.005mm	0.05mm	41mm	6.3mm
7117-600	610mm	0.006mm	0.06mm	51mm	7.9mm
7117-900	914mm	0.007mm	0.06mm	64mm	9.5mm

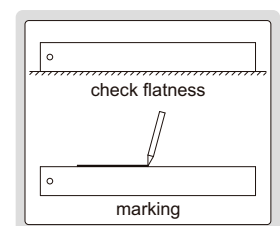

PRECISION STRAIGHT EDGES WITH BEVELED EDGE



7118-300

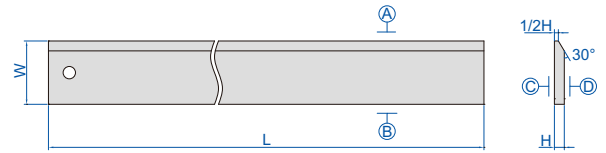

- Check flatness and for marking
- Made of tool steel

Code	Range (L)	Flatness of A and B	Flatness of C and D	W	H
7118-300	305mm	0.005mm	0.05mm	41mm	6.3mm
7118-600	610mm	0.006mm	0.06mm	51mm	7.9mm
7118-900	914mm	0.007mm	0.06mm	64mm	9.5mm

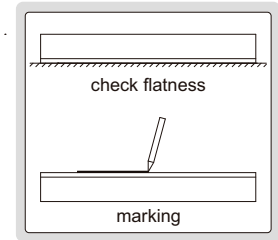

STRAIGHT EDGES

14



7111-300A

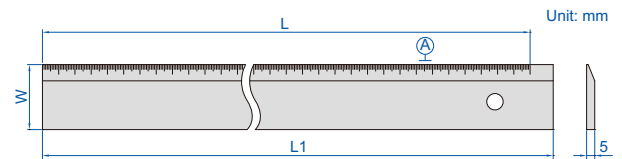

- Check flatness and straightness, as well as for marking
- Graduation on the beveled edge
- Made of hardened tool steel
- Chrome plated
- Graduation: 1mm

Code	Range (L)	Straightness of A	L1	W
7111-300A	300mm	0.02mm	310mm	40mm
7111-500A	500mm	0.03mm	510mm	40mm
7111-1000A	1000mm	0.04mm	1010mm	50mm

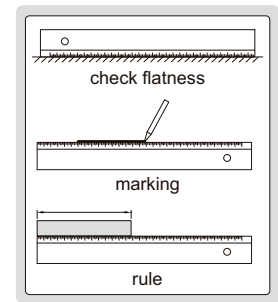

OPTICAL FLATS

- Check flatness
- Single working face, the arrow indicates the working face



4191-45B

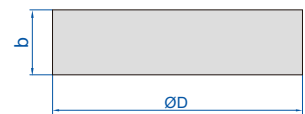

Code	b	ØD	Flatness
4191-45A	12mm	45mm	0.03µm
4191-60A	15mm	60mm	0.03µm

Code	b	ØD	Flatness
4191-45B	12mm	45mm	0.1µm
4191-60B	15mm	60mm	0.1µm

GRANITE HOLDER CAN BE CUSTOMIZED ACCORDING TO WORKPIECES

DATA OUTPUT

STRAIGHTNESS/FLATNESS GAGE



- Optional accessory: data output cable (code 7315-50M page 5, 7302-40M page 13)



2144-200

Unit: mm

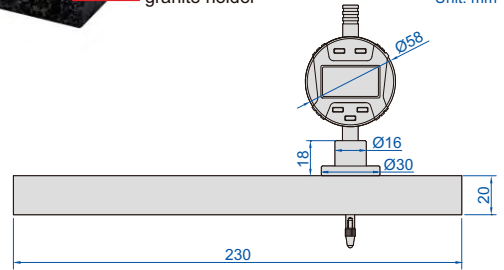

application

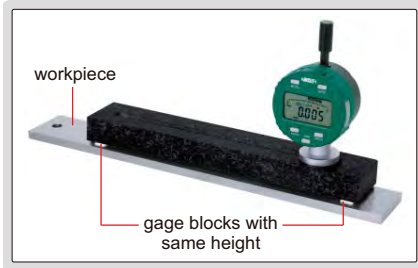

Code	Range	Digital indicator resolution	Straightness measurement accuracy	Parallelism of top and bottom surfaces of granite holder	Flatness of top and bottom surfaces of granite holder
2144-200	200mm	0.001mm/0.00005"	3µm	2µm	1.5µm

GRANITE PLATE CAN BE CUSTOMIZED ACCORDING TO WORKPIECES

DATA OUTPUT

FLATNESS MEASUREMENT STAND



6852-150

- Optional accessory: data output cable (code 7315-50M page 5, 7302-40M page 13, 7305-40M page 9)

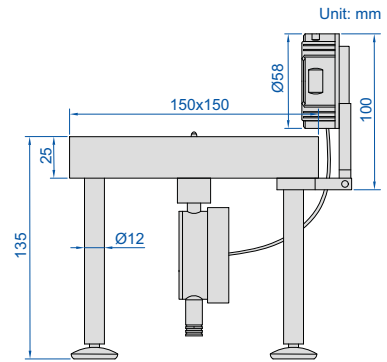

application



Code	Digital indicator resolution	Flatness measurement accuracy	Flatness of granite plate
6852-150	0.001mm/0.00005"	2µm	2µm



Concentricity Gages
Page 353-355

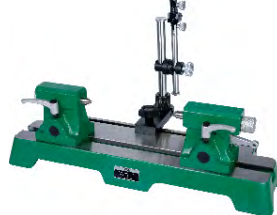

Bench Centers
Page 355-359



V-Blocks
Page 360



Shank Runout Testers
Page 360

CONCENTRICITY GAGES

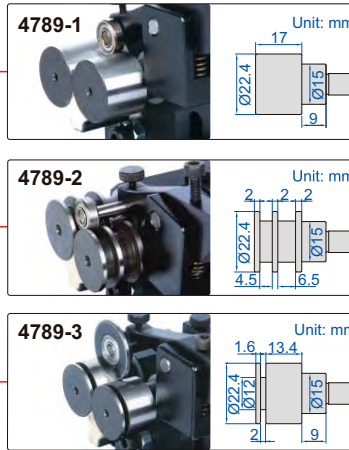

to ensure the accuracy 2 μ m, the distance between measuring point and roller should be <30mm

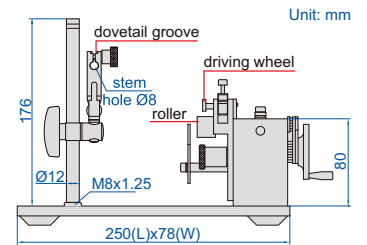
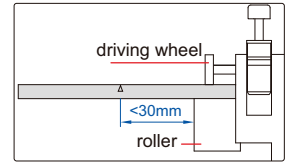

Code	Applicable diameter
4789-1	Ø3.5mm-25mm
4789-2	Ø1mm-25mm
4789-3	Ø1mm-25mm

- Accuracy 2 μ m
- Optional accessory: dial test indicator

HIGH STABILITY,
LONG WORKING LIFE

CONCENTRICITY GAGES

15

dial test indicator is optional



4725-45

dial test indicator is optional



4725-60

dial test indicator is optional



4725-80



to ensure the accuracy 2 μ m, the distance between measuring point and roller should be <30mm

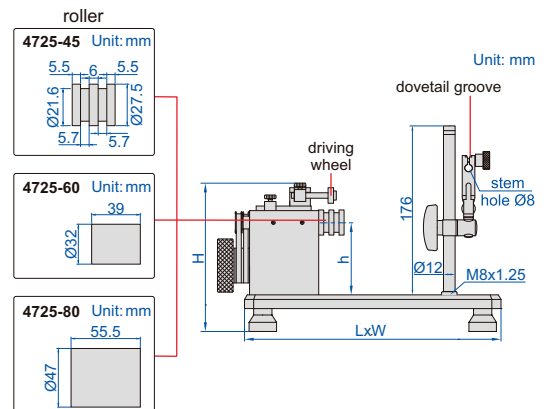
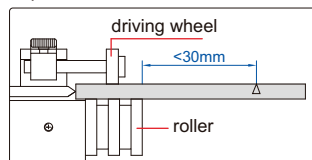

Code	Diameter range	Center height (h)	LxWxH	Weight
4725-45	3-45mm	80mm	280x130x170mm	6kg
4725-60	8-60mm	90mm	350x160x190mm	15.6kg
4725-80	8-80mm	130mm	400x200x250mm	25kg

- With ball bearing, high stability, long working life
- Accuracy 2 μ m
- Optional accessory: dial test indicator

CONCENTRICITY GAGES



QUICK-POSITIONING, SUITABLE FOR MASS MEASUREMENT

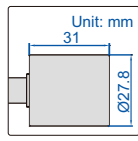

4726-1

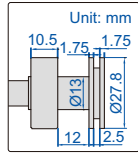

4726-2

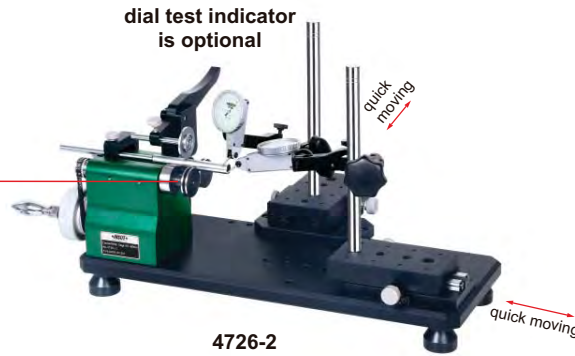

to ensure the accuracy 2µm, the distance between measuring point and roller should be <30mm

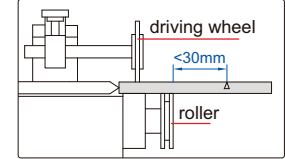

- With ball bearing, high stability, long working life
- Accuracy: 2µm
- Optional accessory: dial test indicator

Code	Applicable diameter
4726-1	Ø4-40mm
4726-2	Ø2-40mm

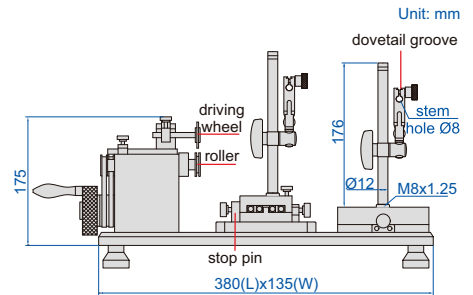

15

CONCENTRICITY GAGE WITH STRAIGHTNESS MEASUREMENT



- Maximum moving range of sliding table: 120mm
- Optional accessory: dial test indicators

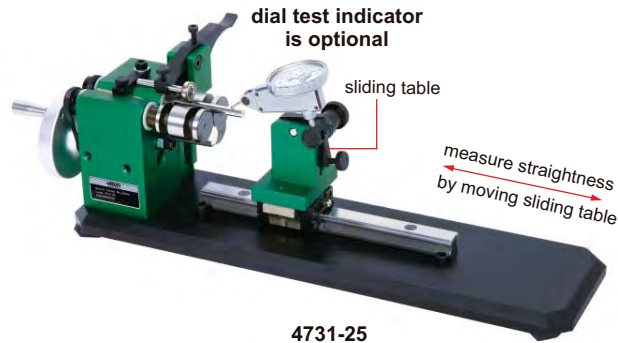

to ensure the accuracy 2µm, the distance between measuring point and roller should be <30mm

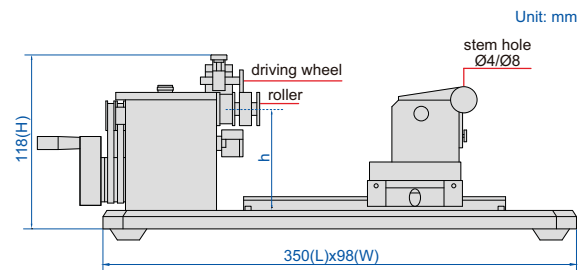
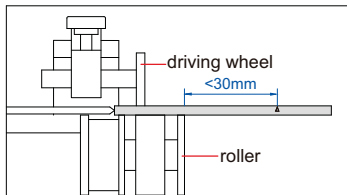

Code	Diameter range	Workpiece length	Roller concentricity accuracy	Straightness measurement accuracy	Center height (h)	L×W×H	Weight
4731-25	Ø1-25mm	15-80mm	2µm	0.01mm	70mm	350×98×118mm	5.3kg

QUICK-POSITIONING, SUITABLE FOR MASS MEASUREMENT

QUICK POSITIONING CONCENTRICITY GAGE



to ensure the accuracy 2µm, the distance between measuring point and roller should be <30mm

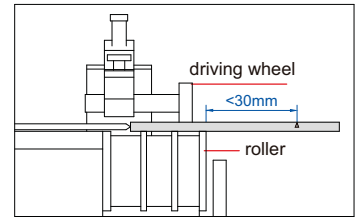

Unit: mm

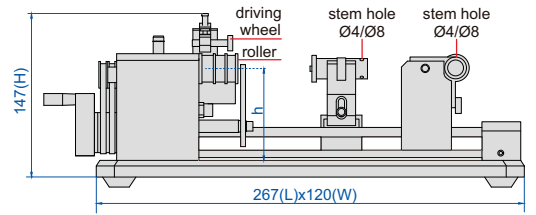

- Quick positioning, suitable for mass measurement
- Optional accessory: dial test indicators

Code	Diameter range	Workpiece length	Accuracy	Center height (h)	L×W×H	Weight
4732-25	Ø0.5-25mm	15-100mm	2µm	70mm	267×120×147mm	5.5kg

CONCENTRICITY GAGE

to ensure the accuracy 3µm, the distance between measuring point and roller should be <50mm

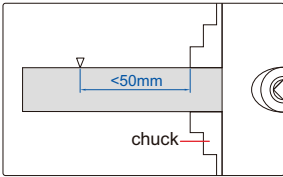

4786-1

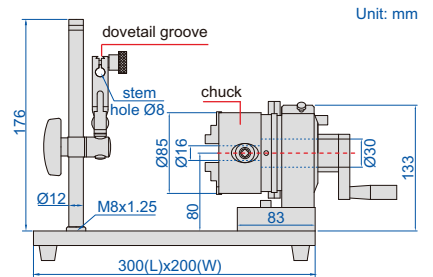

Unit: mm

- Accuracy: 3µm
- Ø50mm setting ring and Ø55mm calibration cylinder are included
- Optional accessory: dial test indicator



for cylinder



for tube

Code	Applicable inside diameter	Applicable outside diameter
4786-1	Ø24-64mm	Ø2-70mm

MINI BENCH CENTER

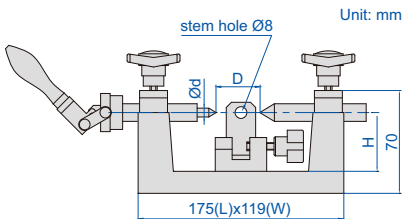

Unit: mm



4721-75A

Code	Runout accuracy	Center height (H)	Distance between two centers (D)	Diameter of center (Ød)	Taper of center	Weight	Load
4721-75A	2µm	40mm	35-100mm	6mm	MT1	4.5kg	4kg

BENCH CENTER WITH STRAIGHTNESS MEASUREMENT



VIDEO

straightness measurement

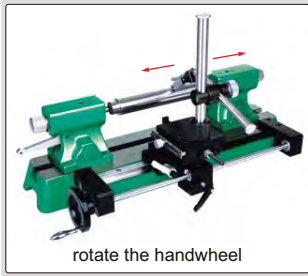

4723-300

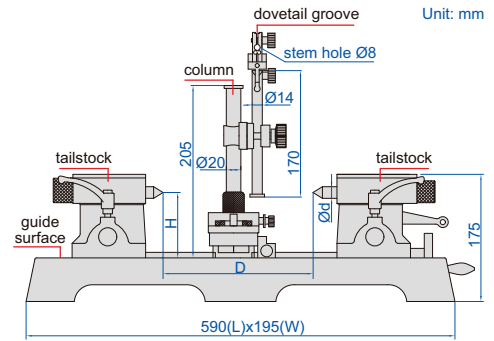

- Hardened cast-iron guide surface

Code	Parallelism *	Runout accuracy	Accuracy of straightness measurement	Center height (H)	Distance between two centers (D)	Diameter of center (Ød)	Taper of center	Weight	Load
4723-300	4µm	2µm	0.02mm	90mm	300mm	18mm	MT2	38kg	25kg

*Parallelism of two centers to the guide surface

BENCH CENTERS

15

rotary centers (optional)

umbrella centers (optional)



4788-300

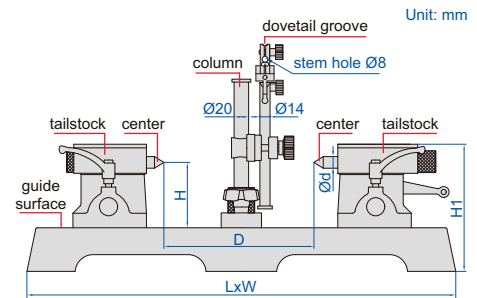

- Movable column
- Optional accessory: umbrella centers, rotary centers

High accuracy

(mm)

Code	Parallelism *	Runout accuracy	Center height (H)	Distance between two centers(D)	L	W	H1	Diameter of center (Ød)	Taper of center	Weight	Load
4788-300	0.010mm	2µm	90	300	590	192	175	18.0	MT2	34kg	25kg
4788-400	0.010mm	2µm	130	400	770	206	241	24.1	MT3	66kg	60kg
4788-600	0.010mm	2µm	130	600	930	220	250	24.1	MT3	90kg	60kg
4788-600H2	0.010mm	2µm	200	600	930	220	325	24.1	MT3	105kg	60kg
4788-1000	0.010mm	3µm	130	1000	1330	220	262	24.1	MT3	112kg	60kg
4788-1000H2	0.010mm	3µm	200	1000	1330	220	337	24.1	MT3	125kg	85kg
4788-1000H3	0.010mm	3µm	300	1000	1330	220	442	31.6	MT4	165kg	85kg

Standard accuracy

(mm)

Code	Parallelism *	Runout accuracy	Center height (H)	Distance between two centers(D)	L	W	H1	Diameter of center (Ød)	Taper of center	Weight	Load
4788-D2	0.010mm	3µm	90	200	490	180	175	20.0	MT2	27kg	25kg
4788-D3	0.010mm	3µm	90	300	590	195	175	20.0	MT2	36kg	25kg
4788-D4	0.012mm	3µm	130	400	730	205	241	28.0	MT3	68kg	60kg
4788-D6	0.015mm	3µm	130	600	930	220	250	28.0	MT3	91kg	60kg
4788-D8	0.015mm	3µm	130	800	1130	220	250	28.0	MT3	99kg	60kg
4788-D10	0.015mm	3µm	130	1000	1330	220	262	28.0	MT3	116kg	60kg

*Parallelism of two centers to the guide surface

BULL NOSE CENTERS

- Supplied in pair
- Suitable for 4723 and 4788 series bench centers

Code	Taper of handle
6391-MT2	MT2
6391-MT3	MT3

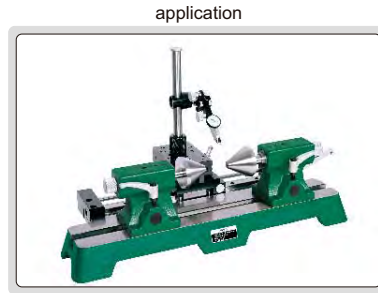

BENCH CENTER (BASIC TYPE)

- Hardened cast-iron guide surface
- Movable column
- V-slot for cylinder $\varnothing 4\text{--}\varnothing 22\text{mm}$

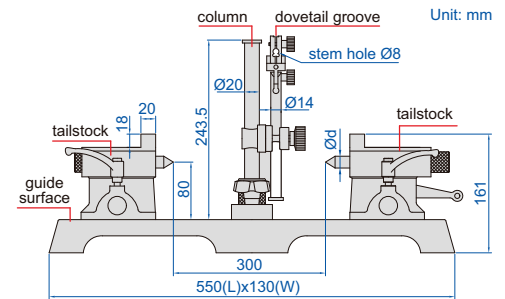
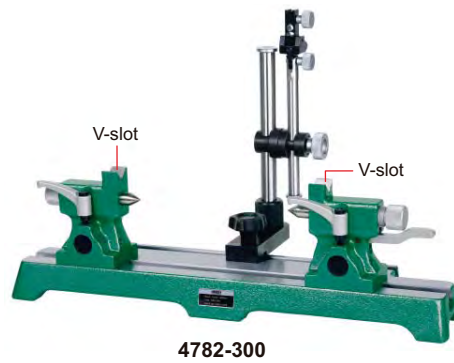

Code	Parallelism*	Runout accuracy	Center height	Distance between two centers	Taper of center	Diameter of center ($\varnothing d$)	Load
4782-300	0.01mm	2 μm	80mm	300mm	MT1	$\varnothing 16\text{mm}$	25kg

*Parallelism of two centers to the guide surface

15

BENCH CENTER WITH ROLLER TAILSTOCKS

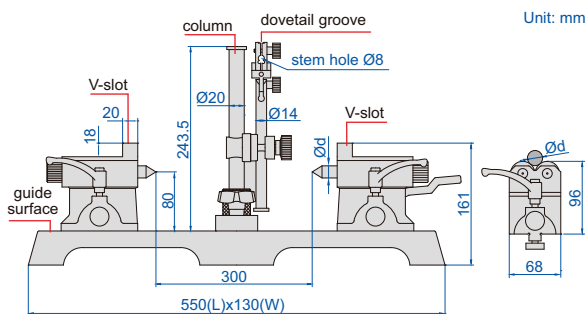

roller tailstocks (included)



- Hardened cast-iron guide surface
- Supplied with V-slot/center tailstocks and roller tailstocks
- V-slot for cylinder $\varnothing 4\text{--}22\text{mm}$
- Roller for cylinder $\varnothing 5\text{--}100\text{mm}$

Code	Parallelism*	Runout accuracy	Center height	Distance between two centers	Diameter of center ($\varnothing d$)	Taper of center	Load
4720-300	0.01mm	2 μm	80mm	300mm	16mm	MT1	25kg (40kg for roller tailstocks)

*Parallelism of two centers to the guide surface

BENCH CENTERS



- Hardened cast-iron guide surface
- Quick moving is suitable for mass production inspection
- Adjustable height tailstock: 0-15mm, suitable for inspecting workpieces with different diameters
- Optional accessory: dial test indicator

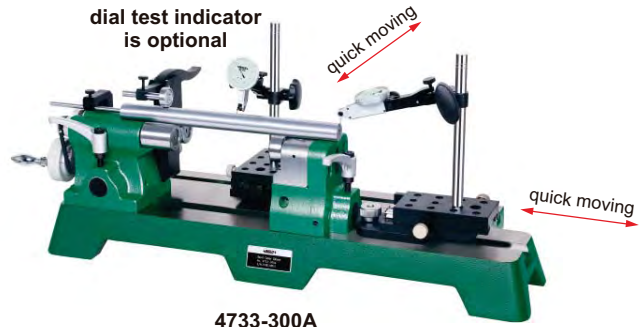

4733-300A

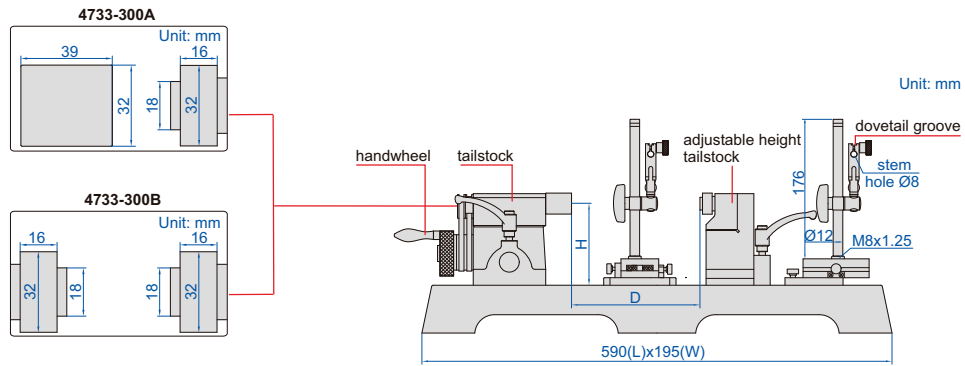

Code	Runout accuracy	Center height (H)	Distance between two centers (D)	Applicable diameter	Adjustable height	Remarks
4733-300A	2µm	90mm	300mm	Ø8-60mm	0-15mm	with handwheel
4733-300B	2µm	90mm	300mm	Ø8-60mm	0-15mm	without handwheel

VERTICAL AND HORIZONTAL BENCH CENTER



vertical use



horizontal use



side use

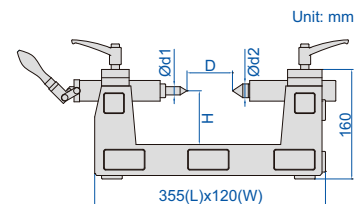

- For vertical, side and horizontal use

Code	Runout accuracy	Center height (H)	Distance between two centers (D)	Diameter of center (Ød1/Ød2)	Weight	Load
4722-200	2µm	80mm	200mm	16mm/20.2mm	22kg	25kg

VERTICAL BENCH CENTER

- Distance between two centers (L): 360mm
- Hardened cast-iron guide surface
- Use handwheel to move the tailstock
- Optional accessory: magnetic stands, dial test indicators

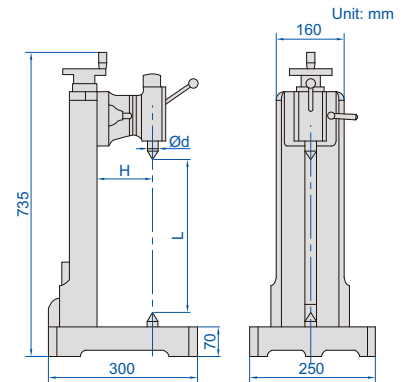
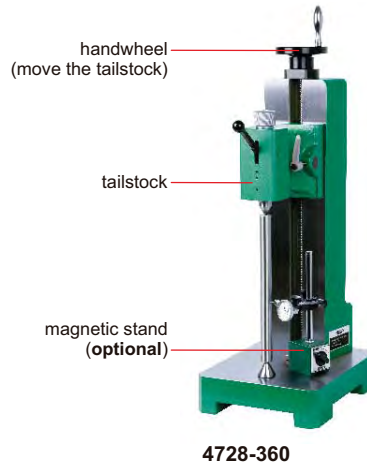

Code	Parallelism*	Runout accuracy	Center height (H)	Diameter of center (Ød)	Taper of center	Weight	Load
4728-360	0.01mm	2µm	130mm	24.1mm	MT3	85kg	80kg

*Parallelism of two centers to the guide surface

TAPER INSPECTION INSTRUMENTS

15

CAN BE CUSTOMIZED

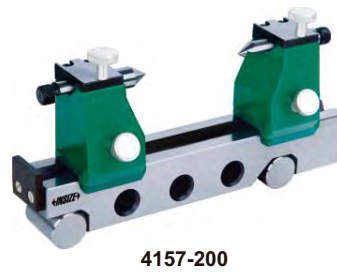
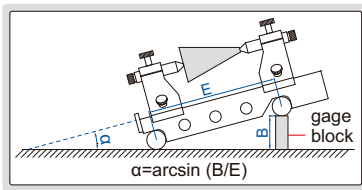

4157-200

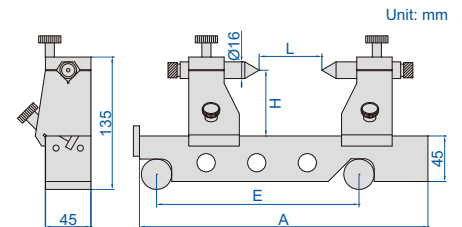

- Check the taper angle of taper bar/taper plug gages /Morse taper/ISO taper etc. The run out can be checked as well

Code	Center height (H)	Center distance (L)	Sine bar accuracy (when α=30°)	E	A
4157-200	65mm	200mm	±5 seconds	200mm	285mm
4157-300	65mm	300mm	±8 seconds	300mm	385mm

REFER TO PAGE 411 FOR DETAILS

MAGNETIC SQUARE WITH V GROOVE



6539-100

V-BLOCKS

REFER TO PAGE
404-410 FOR DETAILS



6896-11



6887-3



6897-1



6890-702



6888-1



6878-1



6891-1

SHANK RUNOUT TESTERS



4771-30

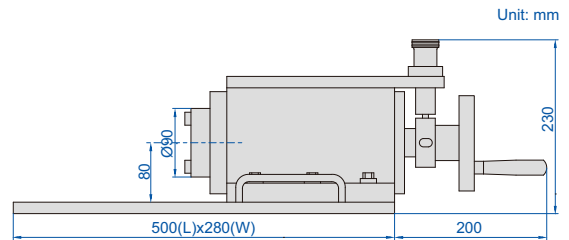

- Measure the radial runout of shanks, collets and cutting tools
- Optional accessory: dial test indicators, magnetic stands

measure radial runout of shank

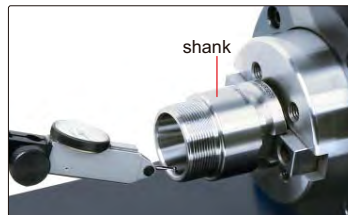

measure radial runout of collet

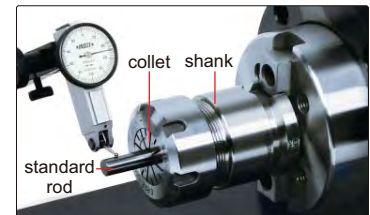

standard shank
(included)



measure radial runout of cutter

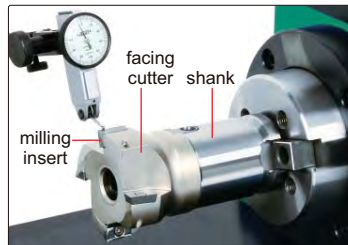

measure radial runout of end mill

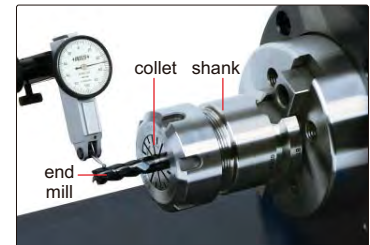

Code	Taper	Accuracy
4771-30	BT30	1µm
4771-40	BT40	1µm
4771-50	BT50	1µm



Feeler Gages
Page 363-366



Pitch Gages
Page 367-368



Gear Tooth Pitch Gages
Page 368

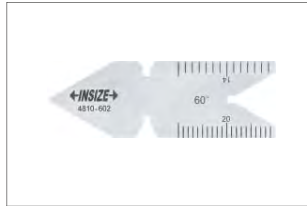

Center Gages
Page 368



Thread Gages
Page 369

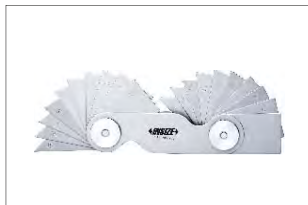

Angle Gages
Page 369



Radius Gages
Page 370



Drill Gages
Page 371



Angle Gages
Page 371

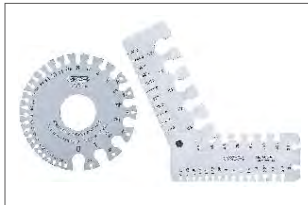

Wire Gages
Page 372

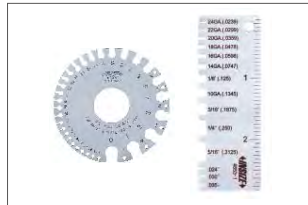

Thickness Gages
Page 372-373

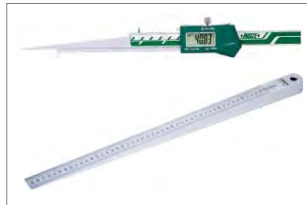

Taper Slot Gages
Page 373-374



Taper Gages
Page 374



Taper Bore Gages
Page 375



Welding Gages
Page 375-376



Fillet Welding Gages
Page 376-377



Welding Gages
Page 377-382



Pipe Welding Gages
Page 381

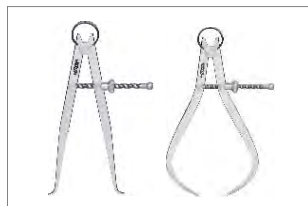

Inside/Outside Calipers
Page 383

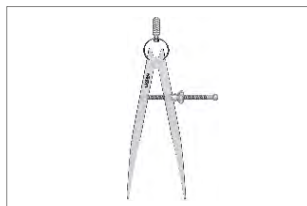

Dividers
Page 384

16

SIMPLE MEASUREMENT TOOLS



Measuring Tapes
Page 384-386



Long Measuring Tapes
Page 386



Measuring Wheels
Page 386-387



Digital Measuring Wheels
Page 387



Steel Rules
Page 387-389



Combination Squares
Page 389-391



T-bevels
Page 391



Plastic Angle Squares
Page 392



Marking Gages
Page 392



Center Marking Gages
Page 392



Scribing Calipers
Page 393



Height Scribes
Page 394



Scribers
Page 394



Precision Screwdriver Sets
Page 394



LED Flashlights
Page 394



Measuring Tool Sets
Page 395-399

FEELER GAGE



4601-25

- Made of hardened alloy steel
- Meet DIN2275/grade TC1
- Accuracy: $\pm(3+T/80)$ μm ,
'T' is the thickness of leaves in μm

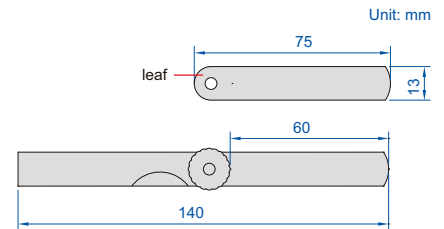

Code	Range	Thickness of leaves included (mm)	Quantity of leaves
4601-25	0.04-1.00mm	0.04, 0.05, 0.06, 0.07, 0.08, 0.09, 0.10, 0.15, 0.20, 0.25, 0.30, 0.35, 0.40, 0.45, 0.50, 0.55, 0.60, 0.65, 0.70, 0.75, 0.80, 0.85, 0.90, 0.95, 1.00	25

FEELER GAGES

16



4602-20

- Made of hardened alloy steel
- Meet DIN2275/grade TC1
- Accuracy: $\pm(3+T/80)$ μm ,
'T' is the thickness of leaves in μm

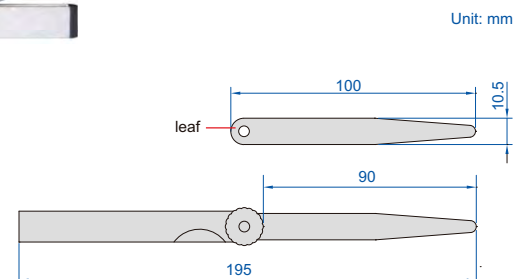

Code	Range	Thickness of leaves included (mm)	Quantity of leaves
4602-13A	0.03-0.50mm	0.03, 0.04, 0.05, 0.06, 0.07, 0.08, 0.09, 0.10, 0.15, 0.20, 0.30, 0.40, 0.50	13
4602-13	0.05-1.00mm	0.05, 0.10, 0.15, 0.20, 0.25, 0.30, 0.40, 0.50, 0.60, 0.70, 0.80, 0.90, 1.00	13
4602-17	0.02-1.00mm	0.02, 0.03, 0.04, 0.05, 0.06, 0.07, 0.08, 0.09, 0.10, 0.15, 0.20, 0.25, 0.30, 0.40, 0.50, 0.75, 1.00	17
4602-20	0.05-1.00mm	0.05, 0.10, 0.15, 0.20, 0.25, 0.30, 0.35, 0.40, 0.45, 0.50, 0.55, 0.60, 0.65, 0.70, 0.75, 0.80, 0.85, 0.90, 0.95, 1.00	20
4602-28	0.05-1.00mm	0.05, 0.06, 0.07, 0.08, 0.09, 0.10, 0.11, 0.12, 0.13, 0.14, 0.15, 0.20, 0.25, 0.30, 0.35, 0.40, 0.45, 0.50, 0.55, 0.60, 0.65, 0.70, 0.75, 0.80, 0.85, 0.90, 0.95, 1.00	28
4602-32	0.03-1.00mm	0.03, 0.04, 0.05, 0.06, 0.07, 0.08, 0.09, 0.10, 0.13, 0.15, 0.18, 0.20, 0.23, 0.25, 0.28, 0.30, 0.33, 0.35, 0.38, 0.40, 0.45, 0.50, 0.55, 0.60, 0.63, 0.65, 0.70, 0.75, 0.80, 0.85, 0.90, 1.00	32

LONG FEELER GAGES



4605-20

- Made of hardened alloy steel
- Meet DIN2275/grade TC1
- Accuracy: $\pm(3+T/80)$ μm , 'T' is the thickness of leaves in μm

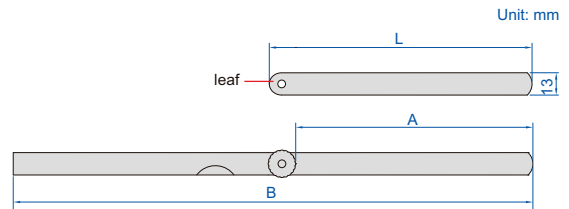

Code	Range	Thickness of leaves included (mm)	Quantity of leaves	L	A	B
4605-13	0.05-1.00mm	0.05, 0.10, 0.15, 0.20, 0.25, 0.30, 0.40, 0.50, 0.60, 0.70, 0.80, 0.90, 1.00	13	150mm	135mm	295mm
4605-131	0.05-1.00mm		13	200mm	185mm	395mm
4605-132	0.05-1.00mm		13	300mm	285mm	590mm
4605-20	0.05-1.00mm	0.05, 0.10, 0.15, 0.20, 0.25, 0.30, 0.35, 0.40, 0.45, 0.50, 0.55, 0.60, 0.65, 0.70, 0.75, 0.80, 0.85, 0.90, 0.95, 1.00	20	150mm	135mm	295mm
4605-201	0.05-1.00mm		20	200mm	185mm	395mm
4605-202	0.05-1.00mm		20	300mm	285mm	590mm

INCH FEELER GAGE

- 0.010" is made of brass, others are made of hardened alloy steel
- Each blade is marked with inch/metric size



4608-31

Code	Range	Quantity of Leaves
4608-31	0.0015"~0.035"	32

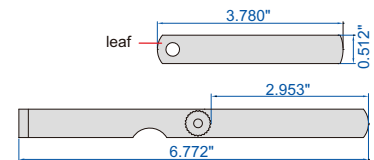

Thickness of leaves included	Accuracy
0.010" (brass)	$\pm 0.00039"$
0.0015", 0.002"	$\pm 0.0002"$
0.0025", 0.003", 0.004", 0.005", 0.006", 0.007"	$\pm 0.00028"$
0.008", 0.009"	$\pm 0.00035"$
0.010", 0.011"	$\pm 0.00039"$
0.012", 0.013"	$\pm 0.00047"$
0.014", 0.015"	$\pm 0.00051"$

Thickness of leaves included	Accuracy
0.016", 0.017"	$\pm 0.00055"$
0.018", 0.019"	$\pm 0.00059"$
0.020", 0.021"	$\pm 0.00067"$
0.022", 0.023"	$\pm 0.00071"$
0.024", 0.025", 0.026"	$\pm 0.00075"$
0.028"	$\pm 0.00091"$
0.030"	$\pm 0.00094"$
0.032", 0.035"	$\pm 0.00102"$

PLASTIC FEELER GAGES



4623-2

Unit: mm

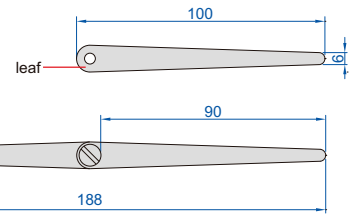

- Accuracy: $\pm 0.04\text{mm}$ (thickness of leaves: 0.25mm)
 $\pm 0.05\text{mm}$ (thickness of leaves: 0.5mm)
 $\pm 0.08\text{mm}$ (thickness of leaves: $\geq 1\text{mm}$)

Code	Range	Thickness of leaves included	Quantity of leaves
4623-2	0.25-2.00mm	2.00mm (0.078"), 1.00mm (0.039"), 0.50mm (0.020"), 0.50mm (0.020"), 0.50mm (0.020"), 0.25mm (0.010"), 0.25mm (0.010"), 1.00mm (0.039"), 2.00mm (0.078"), 1.00mm (0.039"), 2.00mm (0.078"), 1.00mm (0.039"), 2.00mm (0.078")	13
4623-5	0.25-5.00mm	1.00mm (0.039"), 0.25mm (0.010"), 0.50mm (0.020"), 1.50mm (0.059"), 2.00mm (0.078"), 2.50mm (0.098"), 3.00mm (0.118"), 3.50mm (0.138"), 4.00mm (0.157"), 4.50mm (0.177"), 5.00mm (0.196")	11

16

PLASTIC FEELER GAGE

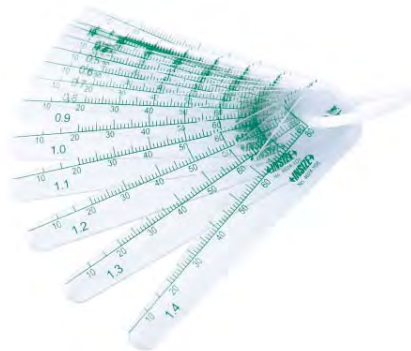

4624-1D5

Unit: mm

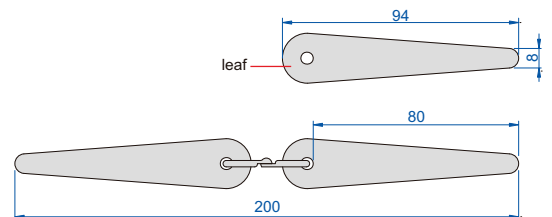

- Accuracy: $\pm 0.02\text{mm}$ (thickness of leaves: 0.05-0.1mm)
 $\pm 0.03\text{mm}$ (thickness of leaves: 0.15-0.6mm)
 $\pm 0.04\text{mm}$ (thickness of leaves: $\geq 0.7\text{mm}$)

Code	Range	Thickness of leaves included (mm)	Quantity of leaves
4624-1D5	0.05-1.5mm	0.05, 0.1, 0.15, 0.2, 0.3, 0.4, 0.5, 0.6, 0.7, 0.8, 0.9, 1.0, 1.1, 1.2, 1.3, 1.4, 1.5	17

FEELER GAGE STOCKS



- Used as shims to accurately set spacing
- Made of hardened alloy steel
- Length 300mm
- Width 13mm
- 10 pcs per package



4622-10

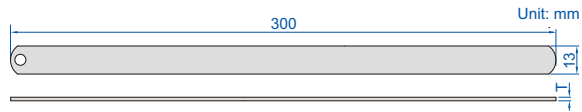

Code	Thickness (T)	Accuracy
4622-02	0.02mm	±3µm
4622-03	0.03mm	±3µm
4622-04	0.04mm	±3µm
4622-05	0.05mm	±3µm
4622-06	0.06mm	±3µm
4622-07	0.07mm	±4µm
4622-08	0.08mm	±4µm
4622-09	0.09mm	±4µm
4622-10	0.10mm	±4µm
4622-12	0.12mm	±5µm

Code	Thickness (T)	Accuracy
4622-15	0.15mm	±5µm
4622-18	0.18mm	±6µm
4622-20	0.20mm	±6µm
4622-25	0.25mm	±6µm
4622-30	0.30mm	±7µm
4622-35	0.35mm	±7µm
4622-40	0.40mm	±8µm
4622-45	0.45mm	±8µm
4622-50	0.50mm	±9µm
4622-55	0.55mm	±9µm

Code	Thickness (T)	Accuracy
4622-60	0.60mm	±9µm
4622-65	0.65mm	±9µm
4622-70	0.70mm	±12µm
4622-75	0.75mm	±12µm
4622-80	0.80mm	±13µm
4622-85	0.85mm	±13µm
4622-90	0.90mm	±14µm
4622-95	0.95mm	±14µm
4622-100	1.00mm	±16µm

FEELER GAGE TAPES



4621-30

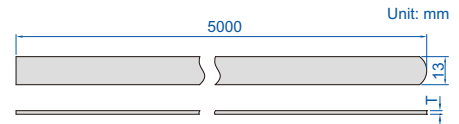

Code	Thickness (T)	Accuracy
4621-02	0.02mm	±4µm
4621-03	0.03mm	±4µm
4621-04	0.04mm	±4µm
4621-05	0.05mm	±4µm
4621-06	0.06mm	±4µm
4621-07	0.07mm	±5µm
4621-08	0.08mm	±5µm
4621-09	0.09mm	±5µm
4621-10	0.10mm	±5µm
4621-12	0.12mm	±5µm
4621-15	0.15mm	±6µm
4621-18	0.18mm	±7µm
4621-20	0.20mm	±8µm
4621-25	0.25mm	±9µm

Code	Thickness (T)	Accuracy
4621-30	0.30mm	±9µm
4621-35	0.35mm	±11µm
4621-40	0.40mm	±12µm
4621-45	0.45mm	±12µm
4621-50	0.50mm	±14µm
4621-55	0.55mm	±14µm
4621-60	0.60mm	±14µm
4621-65	0.65mm	±14µm
4621-70	0.70mm	±17µm
4621-75	0.75mm	±17µm
4621-80	0.80mm	±19µm
4621-85	0.85mm	±19µm
4621-90	0.90mm	±22µm
4621-95	0.95mm	±22µm
4621-100	1.00mm	±24µm

- Used as shims to accurately set spacing
- Made of hardened alloy steel
- Length 5m
- Width 13mm

PITCH GAGES



4820-122

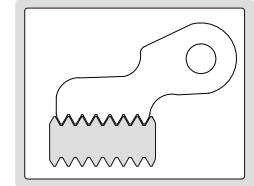

- Identify the pitch of screw thread
- Made of medium carbon steel

Metric 60° screw

Code	Range	Pitch of leaves included (mm)	Quantity of leaves
4820-122	0.4-7.0mm	0.4, 0.5, 0.6, 0.7, 0.75, 0.8, 0.9, 1, 1.25, 1.5, 1.75, 2, 2.5, 3, 3.5, 4, 4.5, 5, 5.5, 6, 6.5, 7	22
4820-124	0.25-7.0mm	0.25, 0.3, 0.35, 0.4, 0.5, 0.7, 0.75, 0.8, 0.9, 1, 1.25, 1.5, 1.75, 2, 2.5, 3, 3.5, 4, 4.5, 5, 5.5, 6, 6.5, 7	24
4820-1241	0.25-6.0mm	0.25, 0.3, 0.35, 0.4, 0.45, 0.5, 0.6, 0.7, 0.75, 0.8, 0.9, 1, 1.25, 1.5, 1.75, 2, 2.5, 3, 3.5, 4, 4.5, 5, 5.5, 6	24

Unified 60° screw

Code	Range	Pitch of leaves included	Quantity of leaves
4820-230	4-42TPI	4, 4-1/2, 5, 5-1/2, 6, 7, 8, 9, 10, 11, 11-1/2, 12, 13, 14, 15, 16, 18, 20, 22, 24, 26, 27, 28, 30, 32, 34, 36, 38, 40, 42TPI	30

Whitworth 55° screw

Code	Range	Pitch of leaves included	Quantity of leaves
4820-330	4-42TPI	4, 4-1/2, 5, 5-1/2, 6, 7, 8, 9, 10, 11, 12, 13, 14, 15, 16, 18, 19, 20, 22, 24, 26, 27, 28, 30, 32, 34, 36, 38, 40, 42TPI	30
4820-328	4-62TPI	4, 4-1/2, 5, 6, 7, 8, 9, 10, 11, 12, 13, 14, 16, 18, 19, 20, 22, 24, 25, 26, 28, 30, 32, 36, 40, 48, 60, 62TPI	28

Metric 60° and Whitworth 55° screw

Code	Range	Pitch of leaves included	Quantity of leaves
4820-452	0.25-6.0mm	0.25, 0.3, 0.35, 0.4, 0.45, 0.5, 0.6, 0.7, 0.75, 0.8, 0.9, 1, 1.25, 1.5, 1.75, 2, 2.5, 3, 3.5, 4, 4.5, 5, 5.5, 6mm	52
	4-62TPI	4, 4-1/2, 5, 6, 7, 8, 9, 10, 11, 12, 13, 14, 16, 18, 19, 20, 22, 24, 25, 26, 28, 30, 32, 36, 40, 48, 60, 62TPI	
4820-450	0.4-7.0mm	0.4, 0.5, 0.6, 0.7, 0.75, 0.8, 0.9, 1, 1.25, 1.5, 1.75, 2, 2.5, 3, 3.5, 4, 4.5, 5, 5.5, 6, 6.5, 7mm	50
	4-62TPI	4, 4-1/2, 5, 6, 7, 8, 9, 10, 11, 12, 13, 14, 16, 18, 19, 20, 22, 24, 25, 26, 28, 30, 32, 36, 40, 48, 60, 62TPI	

Metric 60° and Unified 60° screw

Code	Range	Pitch of leaves included	Quantity of leaves
4820-552	0.4-7.0mm	0.4, 0.5, 0.6, 0.7, 0.75, 0.8, 0.9, 1, 1.25, 1.5, 1.75, 2, 2.5, 3, 3.5, 4, 4.5, 5, 5.5, 6, 6.5, 7mm	52
	4-42TPI	4, 4-1/2, 5, 5-1/2, 6, 7, 8, 9, 10, 11, 11-1/2, 12, 13, 14, 15, 16, 18, 20, 22, 24, 26, 27, 28, 30, 32, 34, 36, 38, 40, 42TPI	

PITCH GAGES

- Check the pitch of screw thread
- Accuracy: $\pm 0.07\text{mm}$
- Made of medium carbon steel



4824-12

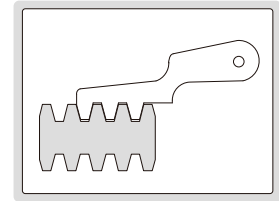

Code	Range	Thread type	Pitch of leaves included	Quantity of leaves
4824-12	2-20mm	Tr30°	2, 3, 4, 5, 6, 7, 8, 9, 10, 12, 16, 20mm	12
4824-16	1-12TPI	ACME 29°	1, 1-1/3, 1-1/2, 1-3/4, 2, 2-1/2, 3, 3-1/2, 4, 5, 6, 7, 8, 9, 10, 12TPI	16

GEAR TOOTH PITCH GAGES

- Check the module pitch of gear tooth
- Accuracy: $\pm 0.05\text{mm}$
- Made of hardened stainless steel



4860-245

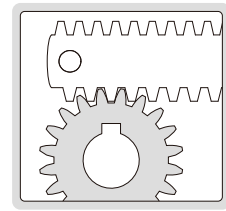

Code	Range	Pressure angle	Quantity of leaves
4860-145	0.35-4.5mm	14.5°	15
4860-245	0.35-4.5mm	20°	15
4860-112	5-12mm	14.5°	8
4860-212	5-12mm	20°	8

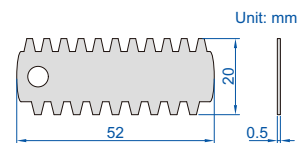

CENTER GAGES

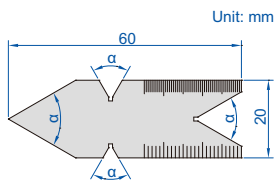

4810-602

- To check and set screw cutting tools, and check the angle and pitch of screw thread
- Angle accuracy: $\pm 30\text{min}$.
- Made of stainless steel

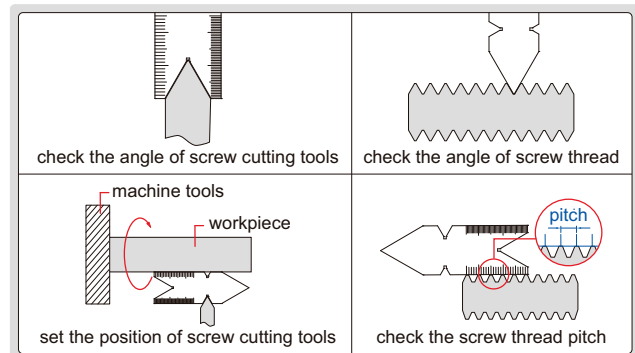

Code	Thread type	Angle (α)	Graduation
4810-601	METRIC 60°	60°	0.5mm and 1mm
4810-602	UNIFIED 60°	60°	14ths and 20ths on front side, 24ths and 32ths on back side
4810-55	WHITWORTH 55°	55°	14ths and 20ths on front side, 24ths and 32ths on back side

THREAD GAGES

- To check and set screw cutting tools
- Made of medium carbon steel



4812-E

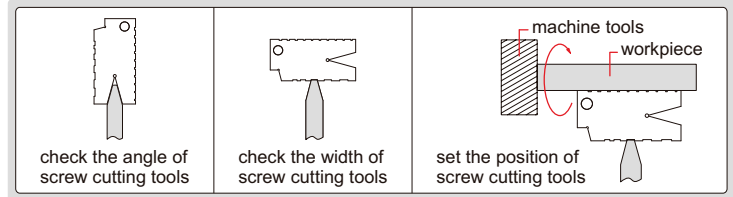
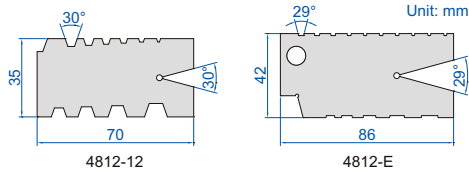

Code	Range	Thread type	Pitch
4812-12	2-12mm	Tr 30°	2, 3, 4, 5, 6, 7, 8, 9, 10, 12mm
4812-E	1-10TPI	ACME 29°	1, 1-1/3, 1-1/2, 1-3/4, 2, 2-1/2, 3, 4, 5, 6, 7, 8, 9, 10TPI

ANGLE GAGE

- To check complementary angles
- Made of stainless steel



4806-20

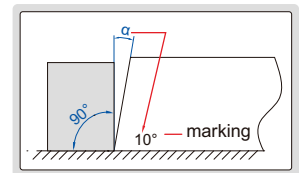

16

Code	Range (α)	Angle of leaves included	Quantity of leaves	Accuracy
4806-20	1°-45°	1°, 2°, 3°, 4°, 5°, 6°, 7°, 8°, 9°, 10°, 12°, 14°, 16°, 18°, 20°, 25°, 30°, 35°, 40°, 45°	20	±30'

ANGLE GAGE SET

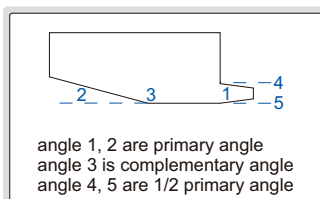

type A

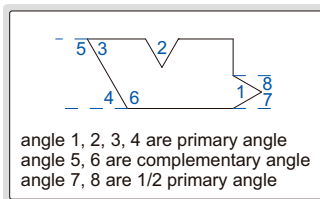

type B



4807

Primary angle	1/2 primary angle	Complementary angle	Type
5°	2°30'	175°	A
10°	5°	170°	A
15°	7°30'	165°	A
20°	10°	160°	B
25°	12°30'	155°	B
30°	15°	150°	B
35°	17°30'	145°	B
40°	20°	140°	B
45°	22°30'	135°	B
50°	25°	130°	B
55°	27°30'	125°	B
60°	30°	120°	B
65°	32°30'	115°	B
70°	35°	110°	B
75°	37°30'	105°	B
80°	40°	100°	B
85°	42°30'	95°	B
90°	45°	90°	B

- Each blade checks primary, 1/2 primary and complementary angles
- Made of medium carbon steel

Code	Quantity of leaves	Accuracy
4807	18	±10'

RADIUS GAGES

- Made of medium carbon steel



4801-17

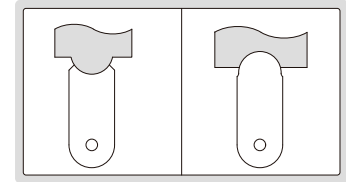

Code	Range	Radius of leaves included (mm)	Quantity of leaves (internal + external)
4801-17	1-7mm	1, 1.25, 1.5, 1.75, 2, 2.25, 2.5, 2.75, 3, 3.5, 4, 4.5, 5, 5.5, 6, 6.5, 7	17+17
4801-16	7.5-15mm	7.5, 8, 8.5, 9, 9.5, 10, 10.5, 11, 11.5, 12, 12.5, 13, 13.5, 14, 14.5, 15	16+16
4801-15	15.5-25mm	15.5, 16, 16.5, 17, 17.5, 18, 18.5, 19, 19.5, 20, 21, 22, 23, 24, 25	15+15

RADIUS GAGE

- Made of stainless steel

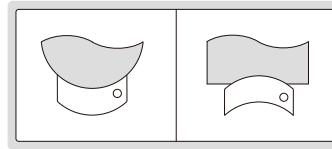

4802-31

Code	Range	Radius of leaves included (mm)	Quantity of leaves
4802-31	25-40mm	25, 25.5, 26, 26.5, 27, 27.5, 28, 28.5, 29, 29.5, 30, 30.5, 31, 31.5, 32, 32.5, 33, 33.5, 34, 34.5, 35, 35.5, 36, 36.5, 37, 37.5, 38, 38.5, 39, 39.5, 40	31

16

RADIUS GAGE SET

- Each piece has 3 concave and 2 convex gauging surfaces
- Supplied with handle
- Made of medium carbon steel

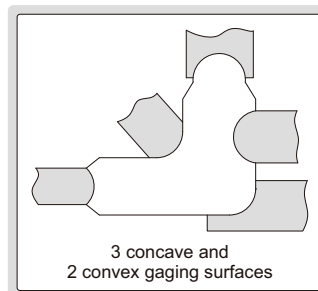

4804-26

Code	Range	Radius of leaves included (mm)	Quantity of leaves
4804-26	0.5-13mm	0.5, 1, 1.5, 2, 2.5, 3, 3.5, 4, 4.5, 5, 5.5, 6, 6.5, 7, 7.5, 8, 8.5, 9, 9.5, 10, 10.5, 11, 11.5, 12, 12.5, 13	26

DRILL POINT GAGE

- For twist drills with 118° angle, to check if the center of tip is concentric with the drill body
- Made of stainless steel

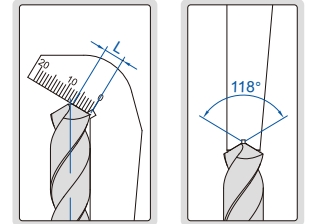
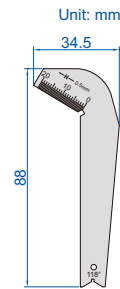

4843-1

Code	Accuracy	
	Angle	Length
4843-1	±0.5°	±0.5mm

DRILL ANGLE GAGE

- Check drills with angle 60°, 70°, 90°, 118°, 125°, 135°, 150° or 160°
- Made of stainless steel

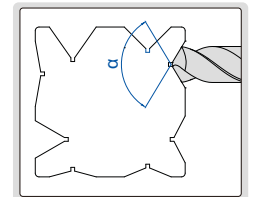
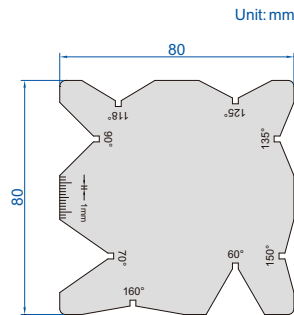

4842-1

Code	Accuracy
4842-1	±0.5°

ANGLE GAGE

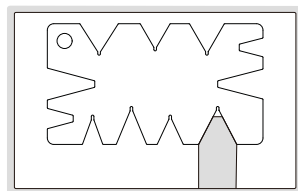

check the angle of screw cutting tools



4854-1

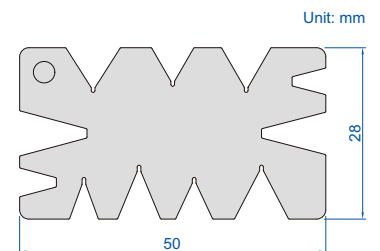

- Made of stainless steel

Code	Range	Accuracy
4854-1	29°, 30°, 40°, 45°, 50°, 55°, 60°	±10'

AMERICAN STANDARD WIRE GAGE



4808

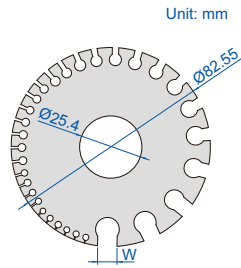

Unit: mm

Code	Range
4808	0-36 (8.250-0.127mm/0.3249-0.0050")

- For gaging non-ferrous wire and metals such as copper, brass and aluminum
- Hardened to HRC50-57

No.	W
0	8.250mm/0.3249"
1	7.350mm/0.2893"
2	6.540mm/0.2576"
3	5.830mm/0.2294"
4	5.190mm/0.2043"
5	4.620mm/0.1819"
6	4.110mm/0.1620"
7	3.670mm/0.1443"
8	3.260mm/0.1285"
9	2.910mm/0.1144"
10	2.590mm/0.1019"
11	2.300mm/0.0907"
12	2.050mm/0.0808"
13	1.820mm/0.0720"
14	1.630mm/0.0641"
15	1.450mm/0.0571"
16	1.290mm/0.0508"
17	1.150mm/0.0453"

No.	W
18	1.020mm/0.0403"
19	0.912mm/0.0359"
20	0.813mm/0.0320"
21	0.724mm/0.0285"
22	0.643mm/0.0253"
23	0.574mm/0.0226"
24	0.511mm/0.0201"
25	0.440mm/0.0179"
26	0.404mm/0.0159"
27	0.361mm/0.0142"
28	0.320mm/0.0126"
29	0.287mm/0.0113"
30	0.254mm/0.0100"
31	0.226mm/0.0089"
32	0.203mm/0.0080"
33	0.180mm/0.0071"
34	0.160mm/0.0063"
35	0.142mm/0.0056"
36	0.127mm/0.0050"

U.S. STANDARD SHEET METAL GAGE



4809

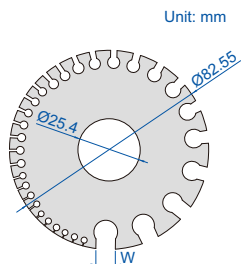

Unit: mm

Code	Range
4809	0-36 (7.938-0.179mm/0.3125-0.0070")

- For gaging sheet metal, plate iron and steel
- Hardened to HRC50-57

No.	W
0	7.938mm/0.3125"
1	7.144mm/0.2813"
2	6.747mm/0.2656"
3	6.350mm/0.2500"
4	5.953mm/0.2344"
5	5.556mm/0.2188"
6	5.159mm/0.2031"
7	4.763mm/0.1875"
8	4.366mm/0.1719"
9	3.969mm/0.1563"
10	3.572mm/0.1406"
11	3.175mm/0.1250"
12	2.778mm/0.1094"
13	2.381mm/0.0938"
14	1.984mm/0.0781"
15	1.786mm/0.0703"
16	1.588mm/0.0625"
17	1.429mm/0.0563"

No.	W
18	1.270mm/0.0500"
19	1.111mm/0.0438"
20	0.953mm/0.0375"
21	0.873mm/0.0344"
22	0.794mm/0.0313"
23	0.714mm/0.0281"
24	0.635mm/0.0250"
25	0.556mm/0.0219"
26	0.476mm/0.0188"
27	0.437mm/0.0172"
28	0.397mm/0.0156"
29	0.357mm/0.0141"
30	0.318mm/0.0125"
31	0.278mm/0.0109"
32	0.258mm/0.0102"
33	0.238mm/0.0094"
34	0.218mm/0.0086"
35	0.198mm/0.0078"
36	0.179mm/0.0070"

WIRE GAGE



4803-1

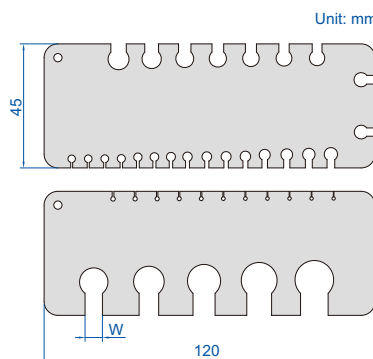

Unit: mm

Code	Range
4803-1	0.2-10mm

- For gaging non-ferrous wire and metals such as copper, brass and aluminum
- Hardened to HRC51-53
- Including 2 pcs wire gages

wire diameter (W)
0.200mm
0.224mm
0.250mm
0.280mm
0.315mm
0.355mm
0.400mm
0.450mm
0.500mm
0.560mm
0.630mm
0.710mm
0.750mm
0.800mm
0.900mm
1.000mm
1.120mm
1.250mm
1.400mm
1.500mm

wire diameter (W)
1.60mm
1.80mm
2.00mm
2.24mm
2.50mm
2.80mm
3.00mm
3.15mm
3.55mm
3.75mm
4.00mm
4.25mm
4.50mm
5.00mm
5.60mm
6.30mm
7.10mm
8.00mm
9.00mm
10.00mm

THICKNESS GAGE

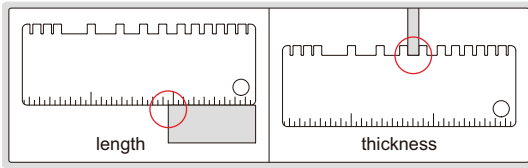

- Made of stainless steel

Code	Measurement	Range	Graduation	Accuracy
4853-1	length	0-2 3/4"	1/16"	1/32"
	thickness	24GA. (0.0239"), 22GA. (0.0299"), 20GA. (0.0359")	—	±0.002"
		18GA. (0.0478"), 16GA. (0.0598"), 14GA. (0.0747"), 1/8" (0.125"), 10GA. (0.1345"), 3/16" (0.1875"), 1/4" (0.250"), 5/16" (0.3125")		±0.004"
		0.024", 0.030", 0.035"		±0.002"

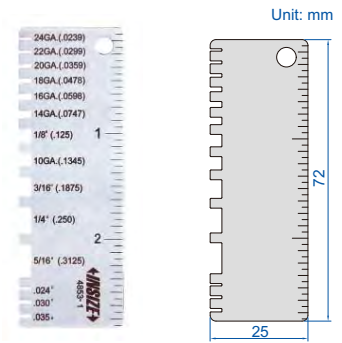

4853-1

DATA OUTPUT

ATTENTION: ACTUAL SLOT WIDTH IS 1/10 OF THE READING

DIGITAL TAPER SLOT GAGES



1160-10

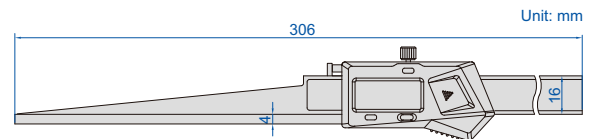
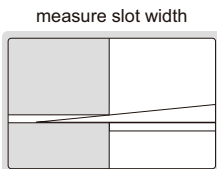

1160-10 and 1160-10WL

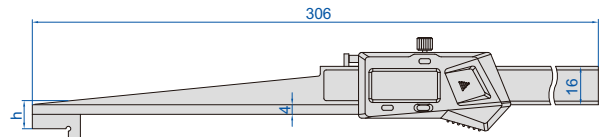

1160-20, 1160-20WL, 1160-30, 1160-30WL, 1160-40 and 1160-40WL

- Non waterproof
- Measuring opening, slot width
- Resolution: 0.01mm/0.0005"
- Buttons: on/off, zero, mm/inch
- Automatic power off, move the digital unit to turn on power
- Battery CR2032
- Made of stainless steel

With data interface (data output cable code 7315-21 page 4, 7302-21 page 12, optional)

Code	Range	Accuracy	h
1160-10	0.2-10mm/0.01-0.39"	±0.03mm	—
1160-20	10-20mm/0.39-0.79"	±0.05mm	10mm
1160-30	20-30mm/0.79-1.18"	±0.05mm	20mm
1160-40	30-40mm/1.18-1.58"	±0.05mm	30mm

Built-in wireless (receiver code 7315-2/3/6/7/8/9 is required)

Code	Range	Accuracy	h
1160-10WL	0.2-10mm/0.01-0.39"	±0.03mm	—
1160-20WL	10-20mm/0.39-0.79"	±0.05mm	10mm
1160-30WL	20-30mm/0.79-1.18"	±0.05mm	20mm
1160-40WL	30-40mm/1.18-1.58"	±0.05mm	30mm

TAPER SLOT GAGES

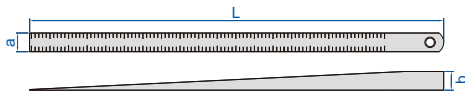

4630-1

- For quick measurement of slot width
- Satin chrome plated reading surface
- Made of stainless steel

Code	Range	Graduation	Accuracy	L	a	b
4630-3	0.4-6mm	0.05mm	±0.04mm	164mm	12.5mm	6.5mm
4630-1	0.5-10mm	0.05mm	±0.07mm	220mm	10mm	10.5mm
4630-2	0.5-15mm	0.1mm	±0.08mm	184mm	12.5mm	16.5mm

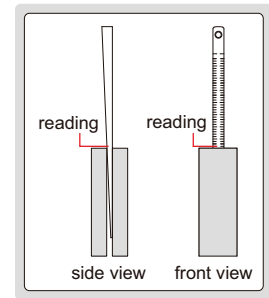

TAPER GAGES

measure diameter of hole

measure slot width

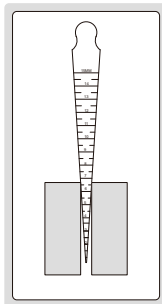
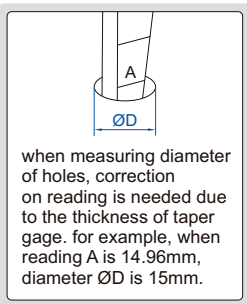

- Measure opening, slot width, hole diameter, etc.
- Diameter correction table on the back (only for 4833-1, 4833-2)
- Made of stainless steel

Code	Range	Graduation	Accuracy	L	W
4833-1	0.8-15mm	0.1mm	±0.05mm	146mm	17mm
4833-2	15-30mm	0.1mm	±0.05mm	159mm	30.4mm
4833-3	30-45mm	0.1mm	±0.05mm	166mm	45.4mm
4833-4	45-60mm	0.1mm	±0.05mm	170mm	60.5mm



front

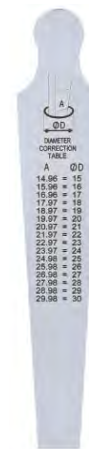

back

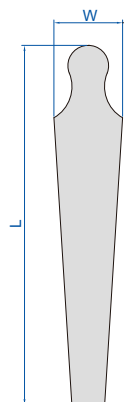

4833-2

TAPER GAGE SET



front

back

4837-1

- Include 4 pcs (1~8mm, 8~15mm, 15~22mm, 22~29mm)
- Measure opening, slot width, hole diameter, etc.
- Diameter correction table on the back
- Made of stainless steel

Code	Range	Graduation	Accuracy
4837-1	1-29mm	0.05mm	±0.05mm

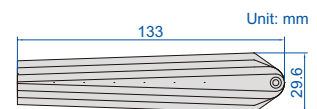

measure diameter of hole

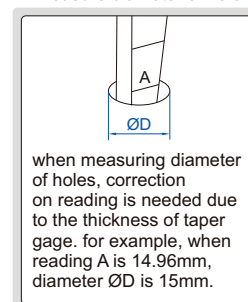

measure slot width

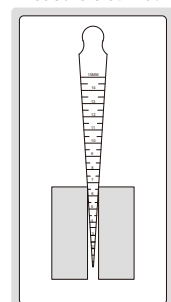

TAPER BORE GAGES

- Quick measurement of bore diameter
- Hardened steel, HRC50-58
- Satin chrome plated surface
- Aluminium oxidized handle

Code	Range	Graduation	Accuracy	L	Ød1	Ød2
4852-1	1-6.5mm	0.1mm	±0.05mm	62.5	7	0.8
4852-3	3-16mm	0.1mm	±0.05mm	143	17	2.8
4852-15	15-30mm	0.1mm	±0.05mm	165	31	14.7
4852-30	30-45mm	0.1mm	±0.05mm	165	46	29.6
4852-45	45-60mm	0.1mm	±0.05mm	167	61	44.3



4852-15

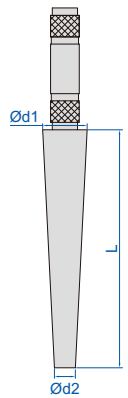

SMALL TAPER BORE GAGE



4855-5

- Quick measurement of small bore diameter
- Hardened working face
- Supplied with protection cap

Code	Range	Graduation	Accuracy
4855-5	0.1-5mm	0.01mm	±0.03mm

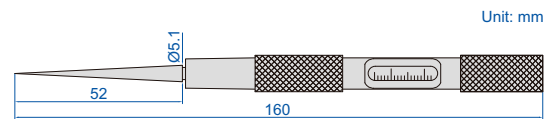

supplied with protection cap



WELDING GAGE



4830

- Made of stainless steel
- Satin chrome plated reading surface

Code	Measurement	Range	Graduation	Accuracy
4830	crown height	0-8mm	0.1mm	±0.1mm
	fillet weld throat size	0-20mm	0.1mm	±0.3mm
	angle	60°, 70°, 80°, 90°	—	±1°

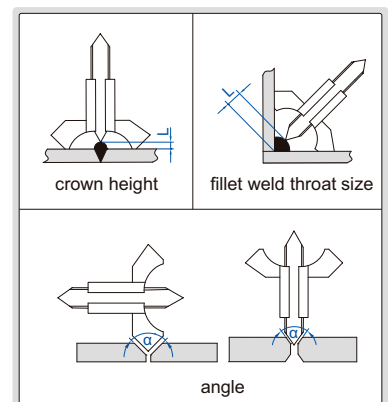
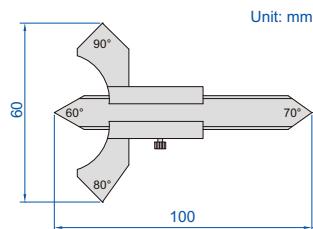

DIGITAL WELDING GAGE

ATTENTION:
NO DATA OUTPUT



4831-20A

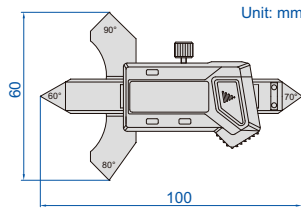

Unit: mm

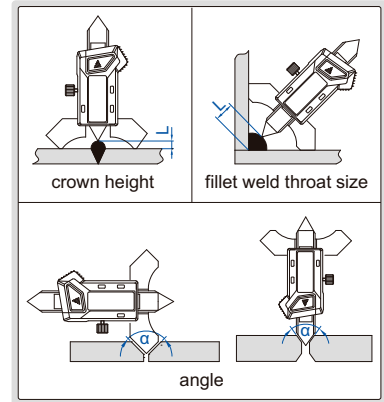

- Non waterproof
- Buttons: zero, mm/inch, on/off
- Battery LR44
- Made of stainless steel

Code	Measurement	Range	Resolution	Accuracy
4831-20A	crown height	0-7mm	0.01mm/0.0005"	±0.03mm
	fillet weld throat size	0-20mm	0.01mm/0.0005"	±0.1mm
	angle	60°, 70°, 80°, 90°	—	±1°

FILLET WELDING GAGE

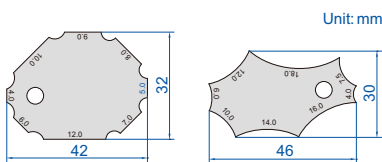

Unit: mm



4832-1

- Made of stainless steel
- Sizes marked on both faces

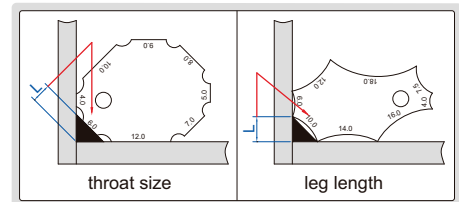

Code	Throat size	Leg length	Accuracy
4832-1	4, 5, 6, 7, 8, 9, 10, 12mm	4, 6, 7.5, 10, 12, 14, 16, 18mm	±0.5mm

FILLET WELDING GAGES

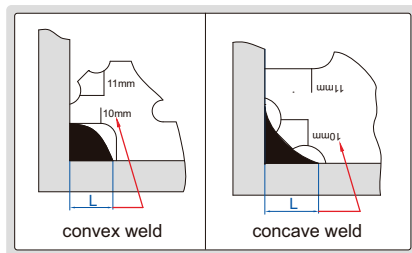

4836-1



4836-2

- Measure concave and convex weld sizes
- 7 blades are included
- Made of stainless steel

Code	Size	Accuracy
4836-1	3mm, 4mm, 5mm, 6mm, 8mm, 9mm, 10mm, 11mm, 12mm, 14mm, 16mm, 19mm, 22mm, 25mm	±0.5mm
4836-2	1/8" (3.2mm), 3/16" (4.8mm), 1/4" (6.4mm), 5/16" (7.9mm), 3/8" (9.5mm), 7/16" (11.1mm), 1/2" (12.7mm), 5/8" (15.9mm), 3/4" (19.1mm), 7/8" (22.2mm), 1" (25.4mm)	±0.02" (0.5mm)

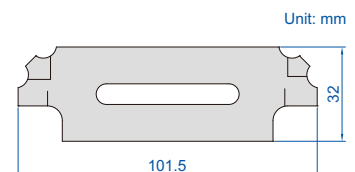

Unit: mm

FILLET WELDING GAGE

- Measure convex weld sizes
- 3 blades are included
- Made of stainless steel



4847-1

Code	Measurement	Range	Graduation	Accuracy
4847-1	convex weld size	4, 6, 8, 10, 12, 14mm	—	±0.5mm
	length	0-50mm	1mm	±0.5mm

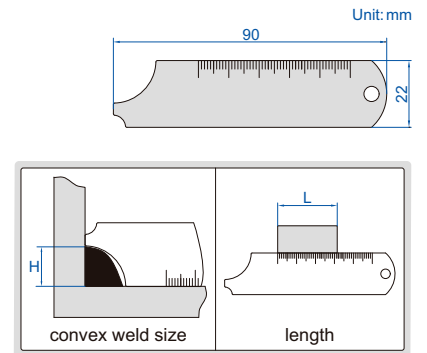

WELDING GAGE

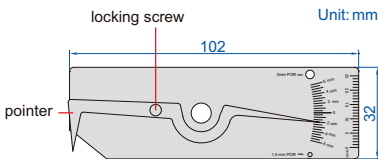

4834-1

- Pointer can be locked for later reference
- Made of stainless steel

Code	Measurement	Range	Graduation	Accuracy
4834-1	undercut depth	0-6mm	0.5mm	±0.5mm
	crown height	0-6mm	0.5mm	±0.5mm
	porosity size comparison	1.5mm, 3mm	—	±0.2mm
	amount of porosity per 25mm	25mm	1mm	—

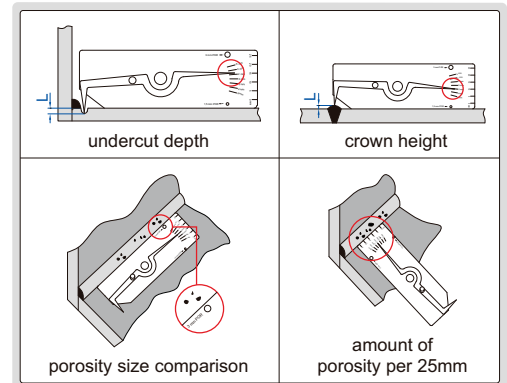

WELDING GAGE

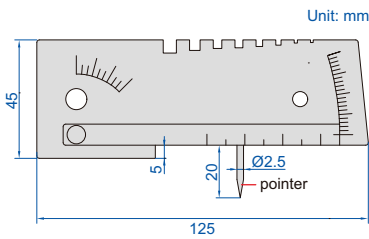

4848-1

- Made of stainless steel

Code	Measurement	Range	Graduation	Accuracy
4848-1	misalignment (high-low)	-5mm~+15mm	1mm	±0.5mm
	angle of preparation	0°-45°	5°	±2.5°
	length	0-50mm	1mm	±0.5mm
	gap	1-4mm	0.5mm	±0.25mm
	thickness	1, 1.2, 2.0, 2.5, 3.0, 3.25, 4.0, 5.0mm	—	—

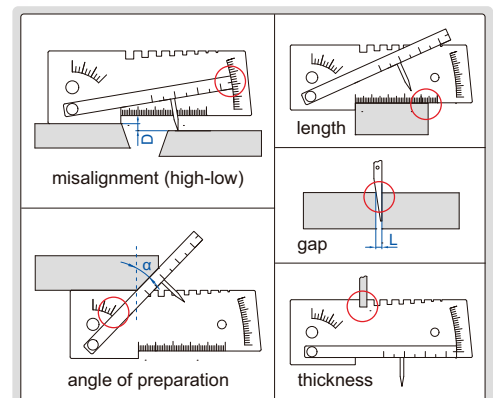

WELDING GAGE



front



back

6832-1

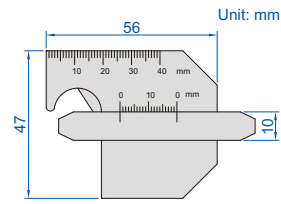

Unit: mm

- Made of stainless steel
- Satin chrome plated surface

Code	Measurement	Range	Graduation	Accuracy
6832-1	leg length	0-20mm	1mm	±0.3mm
	leg height	0-20mm	1mm	±0.3mm
	crown height	0-20mm	1mm	±0.3mm
	throat size	0-10mm	1mm	±0.3mm
	angle	0°-60°	5°	±1°
	gap	1-3.5mm	0.5mm	±0.2mm
	length	0-40mm	1mm	±0.3mm

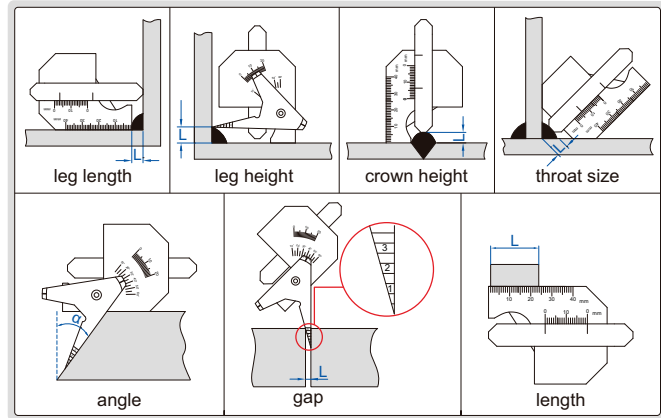

WELDING GAGES

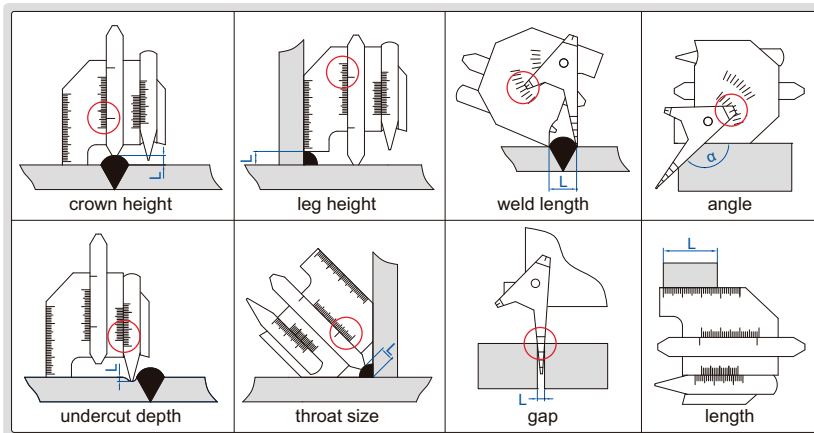

front

4838-1

back

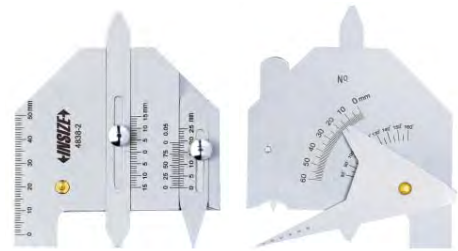

front

4838-2

back

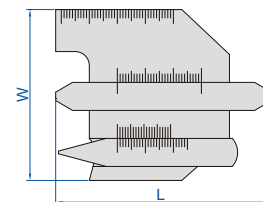

- Made of stainless steel

Measurement	Code 4838-1			Code 4838-2		
	Range	Graduation	Accuracy	Range	Graduation	Accuracy
crown height	0-10mm	1mm	±0.5mm	0-15mm	1mm	±0.5mm
leg height	0-14mm	1mm	±0.5mm	0-15mm	1mm	±0.5mm
undercut depth	0-5mm	0.05mm	±0.05mm	0-5mm	0.05mm	±0.05mm
throat size	0-13mm	1mm	±0.5mm	0-13mm	1mm	±0.5mm
weld length	0-40mm	1mm	±1mm	0-60mm	1mm	±1mm
angle	90°-150°	5°	±1°	80°-160°	5°	±1°
gap	0.5-5mm	1mm	±0.5mm	1-6mm	1mm	±0.5mm
length	0-40mm	1mm	±0.5mm	0-50mm	1mm	±0.5mm
LxW	62x77mm			99x84mm		

WELDING GAGE

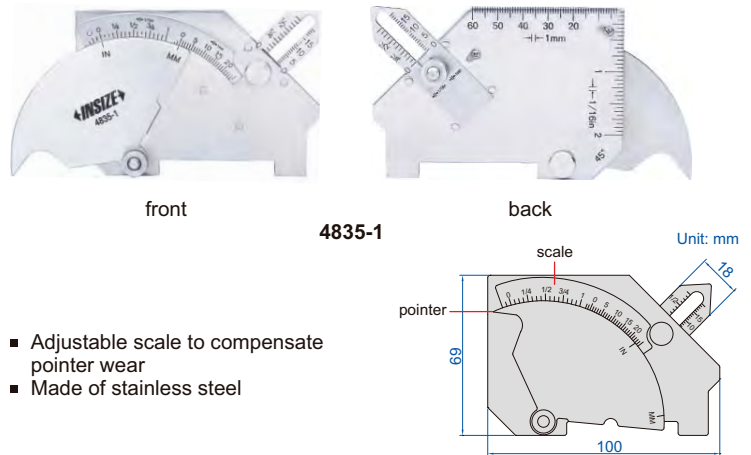
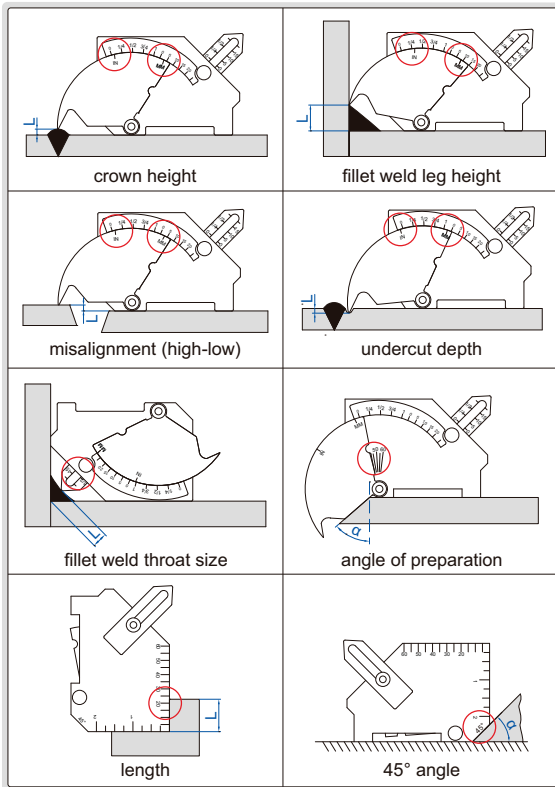

- Adjustable scale to compensate pointer wear
- Made of stainless steel

Code	Measurement	Range	Graduation	Accuracy
4835-1	crown height	0-25mm (0-1")	1mm (1/16")	±0.5mm
	fillet weld leg height	0-25mm (0-1")	1mm (1/16")	±0.5mm
	misalignment (high-low)	0-25mm (0-1")	1mm (1/16")	±0.5mm
	undercut depth	0-2mm (0-1/8")	1mm (1/16")	±0.5mm
	fillet weld throat size	0-20mm (0-3/4")	1mm (1/16")	±0.5mm
	angle of preparation	0-60°	5°	±1°
	length	0-60mm (0-2")	1mm (1/16")	±0.5mm
	45° angle	—	—	±1°

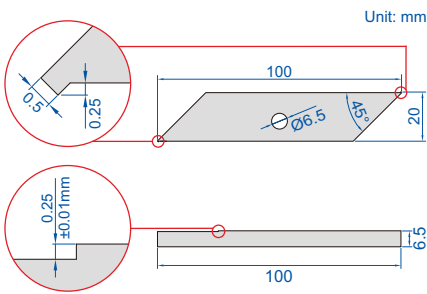

- Code**
4849-1
- Measure undercut
 - Calibration block is included
 - Made of stainless steel



4849-1

calibration block (included)



WELDING UNDERCUT GAGE

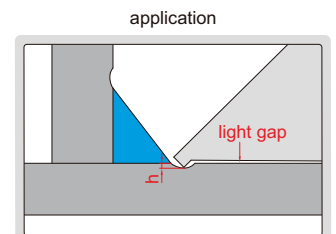

when there is a light gap, $h < 0.25\text{mm}$;
when there is no light gap, $h \geq 0.25\text{mm}$

WELDING GAGE



- Made of stainless steel

4850-1

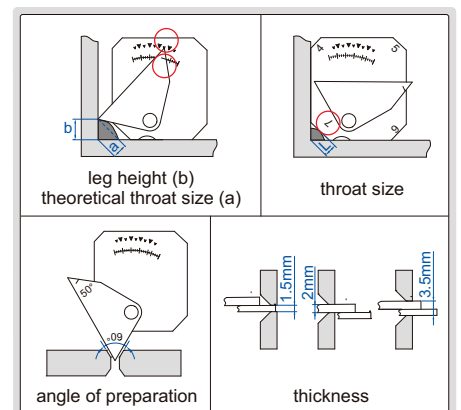
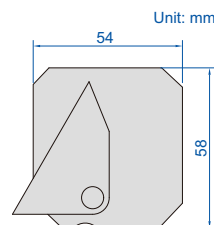

Code	Measurement	Range	Graduation	Accuracy
4850-1	leg height (b)	0-18mm	1mm	±0.5mm
	theoretical throat size (a)	2-12mm	1mm	±0.5mm
	throat size	4, 5, 6, 7mm	—	±0.5mm
	angle of preparation	50°, 60°	—	±1°
	thickness	1.5, 2, 3.5mm	—	±0.2mm

FILLET WELDING GAGE

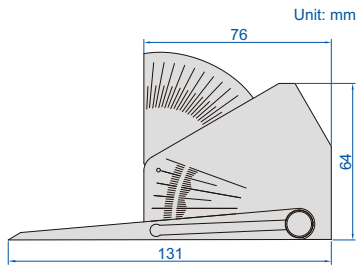

4846-1

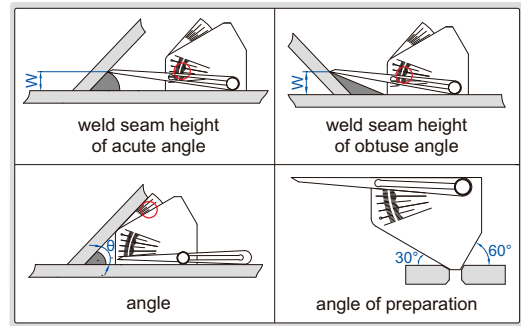

calculating card (included)

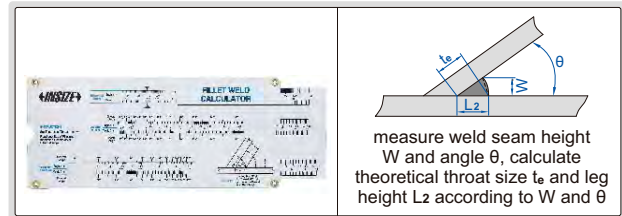

- Calculating card is included
- Made of stainless steel

Code	Measurement	Range	Graduation	Accuracy
4846-1	weld seam height W	0-50mm/0-2"	2mm/0.05"	±1mm
	angle θ	30°-90°	2.5°	±1°
	60° angle	—	—	±0.5°

WELDING GAGE

16



4851-1

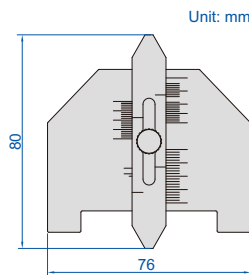

- Made of stainless steel

Code	Measurement	Range	Graduation	Accuracy
4851-1	leg height	0-20mm	1mm	±0.5mm
	crown height	0-3mm	—	±0.5mm
	theoretical leg height of convex weld	0-20mm	1mm	±0.5mm
	theoretical leg height of concave weld	0-20mm	1mm	±0.5mm

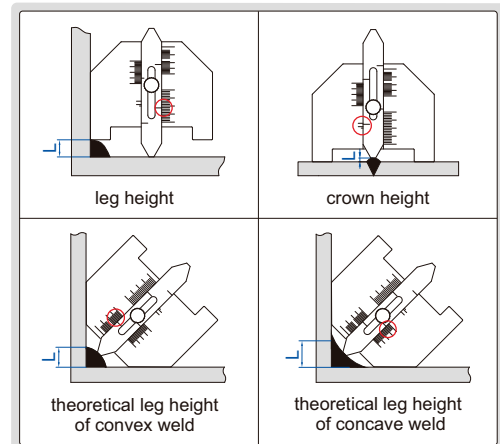

WELDING GAGE

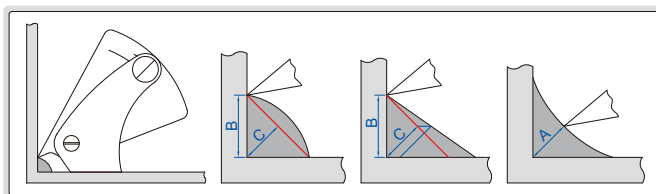

Code	Graduation	Accuracy
4840-1	0.2mm	±0.3mm

- Made of stainless steel

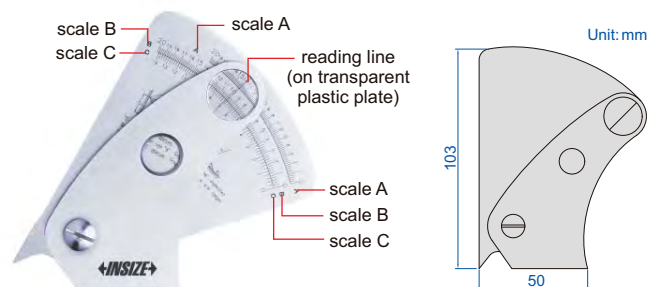

4840-1

PIPE WELDING GAGE

■ Made of stainless steel

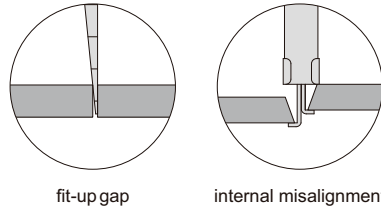

4841-1

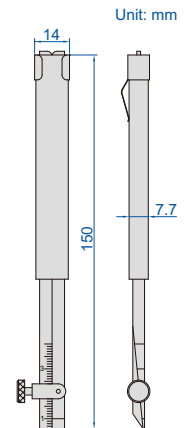

Code	Measurement	Range	Graduation	Accuracy
4841-1	internal misalignment	0-30mm	1mm	±0.5mm
	fit-up gap	0.7-4mm	0.1mm	±0.1mm

PIPE WELDING GAGE

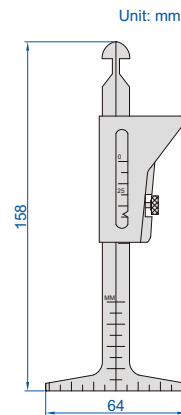
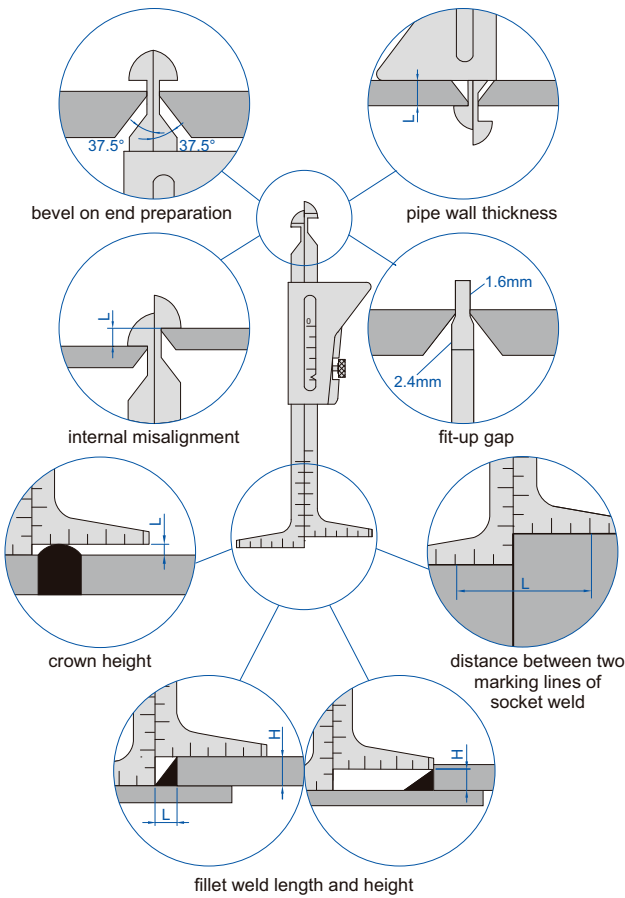

4839-1

Code	Measurement	Range	Graduation	Accuracy
4839-1	bevel on end preparation	37.5°	—	±1°
	pipe wall thickness	0-45mm (0~1-3/4")	1mm (1/16")	±0.5mm
	internal misalignment	0-35mm (0~1-3/8")	1mm (1/32")	±0.5mm
	fit-up gap	1.6mm, 2.4mm	—	±0.1mm
	crown height	0-35mm (0~1-3/8")	1mm (1/32")	±0.5mm
	distance between two marking lines of socket weld	0-60mm (0~2-3/8")	1mm (1/16")	±0.5mm
	fillet weld length	0-30mm (0~1-1/4")	1mm (1/16")	±0.5mm
	fillet weld height	0-35mm (0~1-3/8")	1mm (1/32")	±0.5mm

■ Made of stainless steel

6-PIECE WELDING GAGE SET

■ Includes:

- 1) Welding gage (code **4834-1**)
- 2) Fillet welding gage, size 3~25mm, 7 blades (code **4836-1**)
- 3) Pipe welding gage (code **4841-1**)
- 4) Telescoping inspection mirror, size of mirror Ø32mm, length 178~505mm (code **7160-1**)
- 5) Pocket rule with sliding clip, range 150mm/6", graduation 1mm, 1/64" (code **7119-150**)
- 6) LED flashlight (code **ISGF-0501**)



5064

Code

5064

7-PIECE WELDING GAGE SET

■ Includes:

- 1) Welding gage (code **4834-1**)
- 2) Welding gage (code **4851-1**)
- 3) Pipe welding gage (code **4839-1**)
- 4) Outside micrometer, range 0-25mm, graduation 0.01mm (code **3203-25A**)
- 5) Telescoping inspection mirror, size of mirror Ø32mm, length 178~505mm (code **7160-1**)
- 6) Magnifier with illumination, magnification 4X (code **7513-4**)
- 7) Steel rule, range 150mm/6", graduation 0.5mm, 1mm, 1/64", 1/32", 1/16" (code **7110-150**)



5071

Code

5071

7-PIECE WELDING GAGE SET

■ Includes:

- 1) Welding gage (code **4834-1**)
- 2) Welding gage (code **4851-1**)
- 3) Fillet welding gage, size 3~25mm, 7 blades (code **4836-1**)
- 4) Outside micrometer, range 0-25mm, graduation 0.01mm (code **3203-25A**)
- 5) Digital caliper, range 0-150mm/0-6", resolution 0.01mm/0.005" (code **1108-150**)
- 6) Pocket rule with sliding clip, range 150mm/6", graduation 1mm, 1/64" (code **7119-150**)
- 7) Magnifier with illumination, magnification 4X (code **7513-4**)



5072

Code

5072

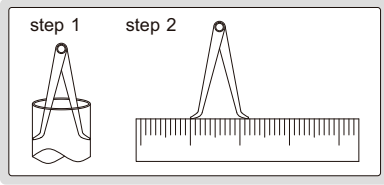

■ Made of carbon steel

Code	Size (L)	Range (W)	h
7240-150	150mm	17-150mm	2mm
7240-200	200mm	17-200mm	3mm
7240-300	300mm	18-300mm	3mm

7240-150



INSIDE CALIPERS

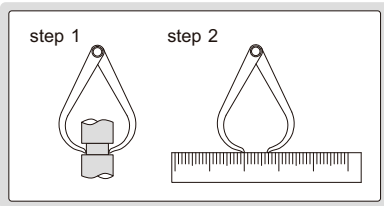
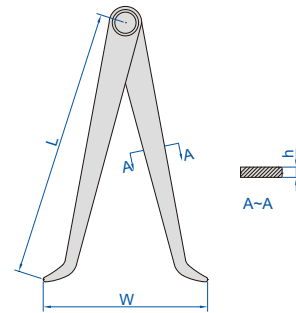

■ Made of carbon steel

Code	Size (L)	Range (W)	h
7241-150	150mm	0-150mm	2mm
7241-200	200mm	0-200mm	3mm
7241-300	300mm	0-300mm	3mm

7241-150



OUTSIDE CALIPERS

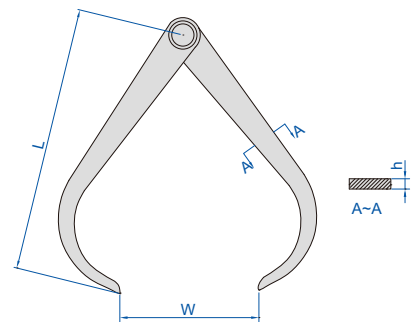

■ Made of carbon steel

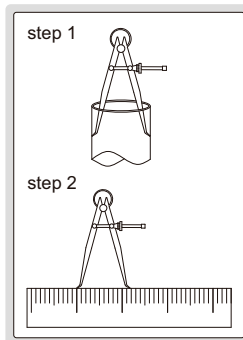

7261-150



INSIDE SPRING CALIPERS

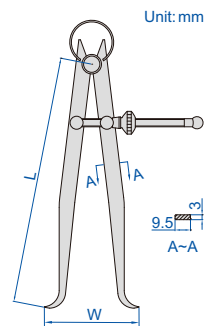

Code	Size (L)	Range (W)
7261-150	150mm	20-170mm
7261-200	200mm	22-220mm
7261-250	245mm	30-270mm
7261-300	300mm	30-320mm

■ Made of carbon steel

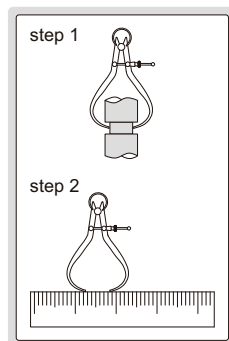

7262-150



OUTSIDE SPRING CALIPERS

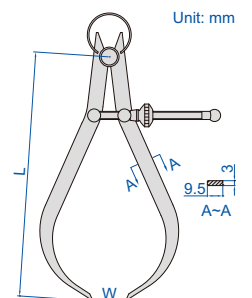

Code	Size (L)	Range (W)
7262-150	155mm	0-140mm
7262-200	210mm	0-210mm
7262-250	265mm	0-270mm
7262-300	310mm	0-320mm

SPRING DIVIDERS

- Made of carbon steel
- Hardened points

Code	Size (L)	Range (W)
7260-150	150mm	0-150mm
7260-200	200mm	0-210mm
7260-250	245mm	0-260mm
7260-300	300mm	0-320mm



7260-150

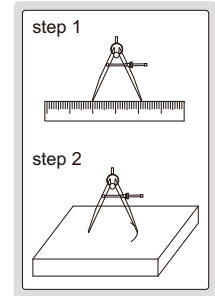
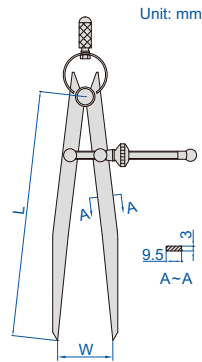

DIVIDERS

16

- Made of carbon steel
- Hardened points

Code	Size (L)	Range (W)	a	b
7247-150	150mm	0-140mm	8.5	7
7247-200	200mm	0-190mm	10	7
7247-300	300mm	0-290mm	12	7



7247-150

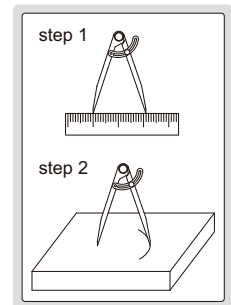
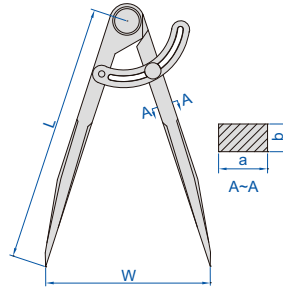

MEASURING TAPES

EG II

graduation

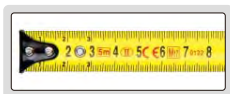

7140-5

- Non-glare nylon surface for wear resistance

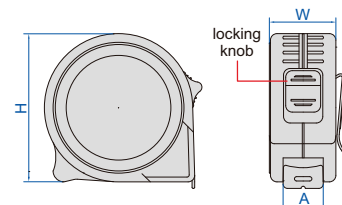

Individual (1 pc per package)

Code	Range	Graduation	Width of tape A	W	H
7140-3	0-3m	1mm	16mm	28mm	62mm
7140-5	0-5m	1mm	19mm	30mm	68mm
7140-8	0-8m	1mm	25mm	38mm	78mm

Set (12 pcs per package)

Code	Range	Graduation	Width of tape A	W	H
7140-3A	0-3m	1mm	16mm	28mm	62mm
7140-5A	0-5m	1mm	19mm	30mm	68mm
7140-8A	0-8m	1mm	25mm	38mm	78mm

EG II

MEASURING TAPES (BASIC TYPE)



7142-5

- Non-glare nylon coating tape, wear resistance



graduation

Individual (1 pc per package)

Code	Range	Graduation	Width of tape A	W	H
7142-5	0-5m/0-16ft	1mm, 1/16"	19mm	31mm	64mm

Set (12 pcs per package)

Code	Range	Graduation	Width of tape A	W	H
7142-5A	0-5m/0-16ft	1mm, 1/16"	19mm	31mm	64mm

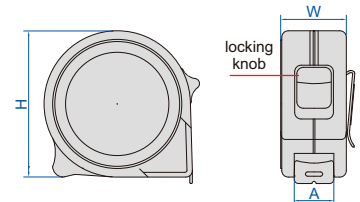

locking knob

BUILT-IN BLUETOOTH

BLUETOOTH DIGITAL MEASURING TAPES+LASER DISTANCE METERS



9563-C40

type-C port

laser receiving lens
laser emitting lens

connect to phone (APP)



- Display with backlight
- Automatic power off: laser 30s, main unit 180s
- Can work continuously for 5 hours

SPECIFICATION

Code		9563-C40	9563-C60
Digital measuring tape	range	5m	
	resolution	0.001m	
	accuracy	±1.5mm	
	blade width	19mm	
	horizontal stand-out	≥1.8m	
Laser distance meter	range	40m	60m
	resolution	0.001m	
	accuracy	±(3+D/20)mm, D: measured distance, unit: m	
	units	m, ft, in, ft+in	
	laser type	630~670nm, <1mW, class 2	
	measurement function	single, area, volume, pythagoras measurement	
Output		bluetooth	
Operation temperature		0~40°C	
Storage temperature		-10~60°C	
Power supply		built-in rechargeable lithium battery	
Dimension (L×W×H)		95×74×56mm	
Weight		313g	

digital measuring tape



laser distance meter



SELF ADHESIVE MEASURING TAPES

type of reading

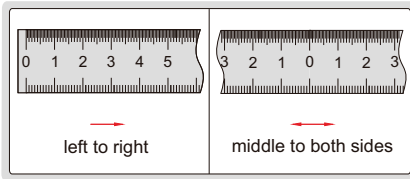

- Self adhesive back
- Steel tape, non-glare coating, wear resistance



7139-50

self adhesive back



Code	Range (L)	Graduation	Accuracy	Type of reading
7139-50	50-0-50cm	1mm	±0.2mm	middle to both sides
7139-100	0-100cm	1mm	±0.4mm	left to right

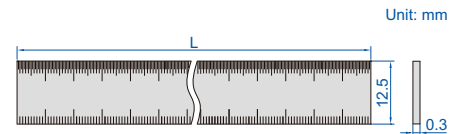

Unit: mm

LONG MEASURING TAPE

EG II

graduation

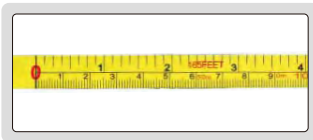

16

- High tensile strength fibreglass tape
- Nylon coating tape, wear resistance

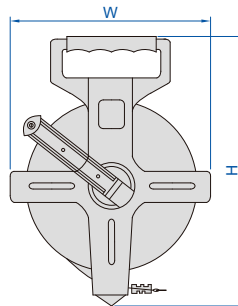

7143-50

Code	Range	Graduation	Width of tape	W	H
7143-50	0-50m/0-165ft	1mm, 1/8"	13mm	220mm	320mm

MEASURING WHEEL (BASIC TYPE)

- ABS plastic frame, wear-resistant PU tire
- Three-section adjustable handle



7144-1

Code	Range	Resolution
7144-1	0.1-9999.9m	0.1m

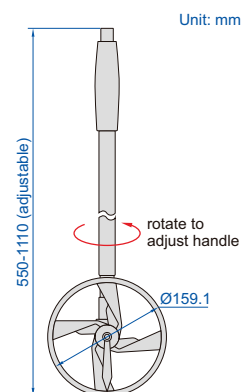

Unit: mm

MEASURING WHEEL

- ABS plastic frame, wear-resistant PU tire
- Two-section foldable handle



after folding



backpack (included)



7145-1

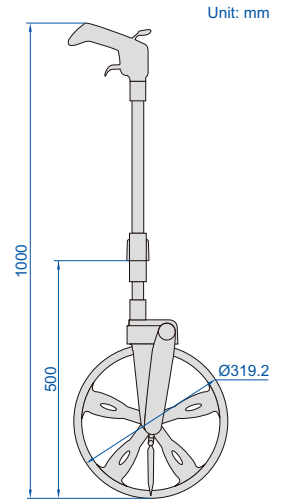

Code	Range	Resolution
7145-1	0.1-9999.9m	0.1m

IP40
WATERPROOF



DIGITAL MEASURING WHEEL

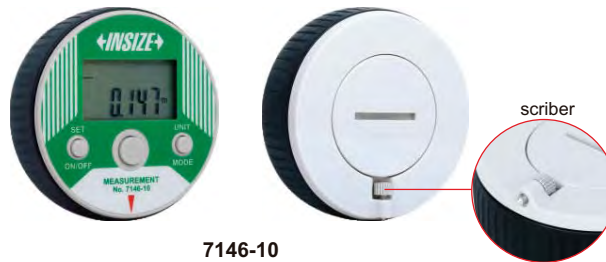

7146-10

- IP40 dust/waterproof
- Measuring length of curve
- Four measurement modes: length, rectangle area, diameter of circle, cube
- Resolution: 0.001m/0.01ft
- Button function: on/off, mm/inch, one or two sides set, measurement mode conversion, measurement
- Battery CR2032, automatic power off

Code	Range	Accuracy
7146-10	0-10m/0-32.8ft	±0.3%L (L is the measured length)

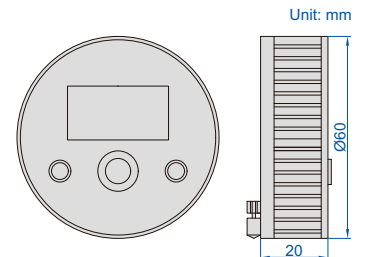

RIGID RULE

- Rigid rules
- With groove on the back, suitable for combination square set (2278 series)
- Satin chrome plated



7113-300A



groove on the back

Code	Range	Graduation		Accuracy	L
		front	back		
7113-300A	300mm/12"	0.5mm and 1/32"	1mm and 1/64"	±0.15mm	300mm

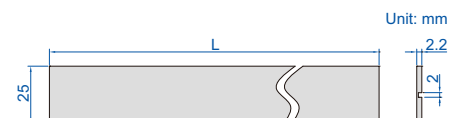

POCKET RULE WITH SLIDING CLIP



7119-150

- With sliding clip, clip can be inserted in the pocket, also can be used as depth gage base
- Inch/metric conversion table on the back
- Made of stainless steel

Code	Range	Graduation	Accuracy
7119-150	150mm/6"	1mm, 1/64"	±0.15mm

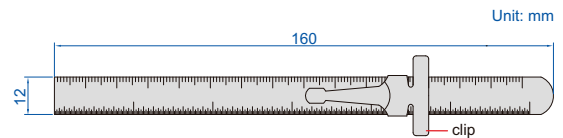

STEEL RULES

POPULAR MODEL



7110-300

- Graduation: 0.5mm, 1mm, 1/64", 1/32", 1/16"
- Rigid rules
- Made of stainless steel
- Non-glare surface

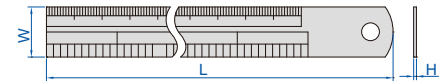

16

Individual (1 pc per package)

(mm)

Code	Range	Accuracy	L	W	H	Remark
7110-150	150mm/6"	±0.18mm	170	18	1.0	graduation on front and back
7110-200	200mm/8"	±0.18mm	220	18	1.0	graduation on front and back
7110-300	300mm/12"	±0.27mm	330	25	1.0	graduation on front and back
7110-3001	300mm/12"	±0.27mm	325	30	1.0	graduation on front and back
7110-500	500mm/20"	±0.27mm	530	30	1.2	graduation on front and back
7110-600	600mm/24"	±0.45mm	630	30	1.2	graduation on front and back
7110-1000	1000mm/40"	±0.45mm	1040	32	1.5	graduation on front and back
7110-1200	1200mm/48"	±0.63mm	1240	35	1.8	graduation on front
7110-1500	1500mm/60"	±0.63mm	1550	38	1.8	graduation on front
7110-2000	2000mm/80"	±0.80mm	2065	40	2.0	graduation on front

Set

(mm)

Code	Range	Accuracy	L	W	H	Remark	Quantity per package
7110-150A	150mm/6"	±0.18mm	170	18	1.0	graduation on front and back	10 pcs
7110-200A	200mm/8"	±0.18mm	220	18	1.0	graduation on front and back	10 pcs
7110-300A	300mm/12"	±0.27mm	330	25	1.0	graduation on front and back	5 pcs
7110-3001A	300mm/12"	±0.27mm	325	30	1.0	graduation on front and back	5 pcs
7110-500A	500mm/20"	±0.27mm	530	30	1.2	graduation on front and back	5 pcs
7110-600A	600mm/24"	±0.45mm	630	30	1.2	graduation on front and back	5 pcs
7110-1000A	1000mm/40"	±0.45mm	1040	32	1.5	graduation on front and back	5 pcs
7110-1200A	1200mm/48"	±0.63mm	1240	35	1.8	graduation on front	5 pcs
7110-1500A	1500mm/60"	±0.63mm	1550	38	1.8	graduation on front	5 pcs
7110-2000A	2000mm/80"	±0.80mm	2065	40	2.0	graduation on front	5 pcs

TAPER GAGE AND STEEL RULER SET



front

4829-1

back

use the taper gage to measure slot width

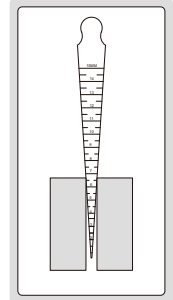

- Diameter correction table on the taper gage back
- Made of stainless steel

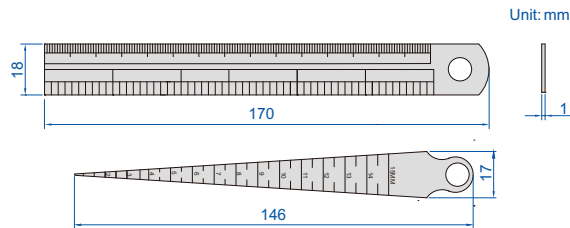

use the taper gage to measure diameter of hole

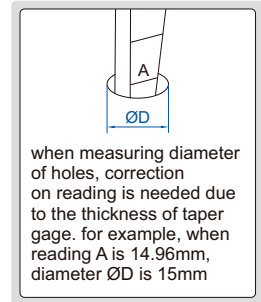

Code	Tool	Range	Graduation	Accuracy
4829-1	taper gage	0.8-15mm	0.1mm	±0.05mm
	steel ruler	150mm/6"	1.0mm	±0.18mm

ALUMINUM RULES

- Made of aluminum, oxidized surface

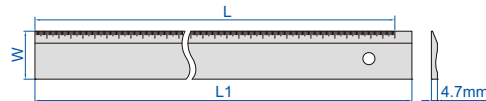

7123-300

Code	Range (L)	Graduation	Accuracy	L1	W
7123-300	300mm	1mm	±0.5mm	321mm	50mm
7123-600	600mm	1mm	±0.9mm	624mm	50mm
7123-1000	1000mm	1mm	±0.9mm	1024mm	50mm

COMBINATION SQUARE (ECONOMIC TYPE)

- Square head (made of zinc): set the blade at 90° or 45° to an edge of a workpiece accuracy: ±0.5°
- Blade (made of stainless steel): range: 300mm/12", graduation: 1mm and 1/32" on front face, 1mm and 1/16" on back face



2276-300

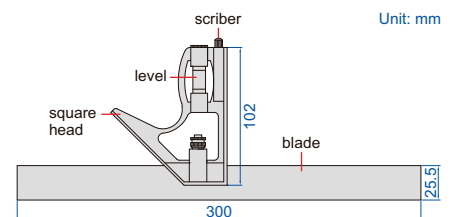
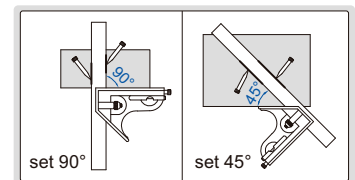

Code
2276-300

COMBINATION SQUARE SETS (CLOSE TYPE PROTRACTOR)



2278-2



2278-3



2278-180

16

- Center head (made of cast iron):
to locate center of cylinders with diameter ($\varnothing d$): 30-100mm
accuracy: $\pm 0.15\text{mm}$
- Protractor head (made of cast iron):
set the blade at desired angle to an edge of a workpiece,
and can be used to measure angles
range: 0-180°
accuracy: $\pm 20\text{min}$.
- Square head (made of cast iron):
set the blade at 90° or 45° to an edge of a workpiece
accuracy: $\pm 8\text{min}$ for 90° square,
 $\pm 10\text{min}$ for 45° square
- Blade (made of stainless steel):
range: 300mm/12",
graduation: 0.5mm and 1/32" on front face,
1mm and 1/64" on back face
- Optional accessory: rigid rule (code 7113)

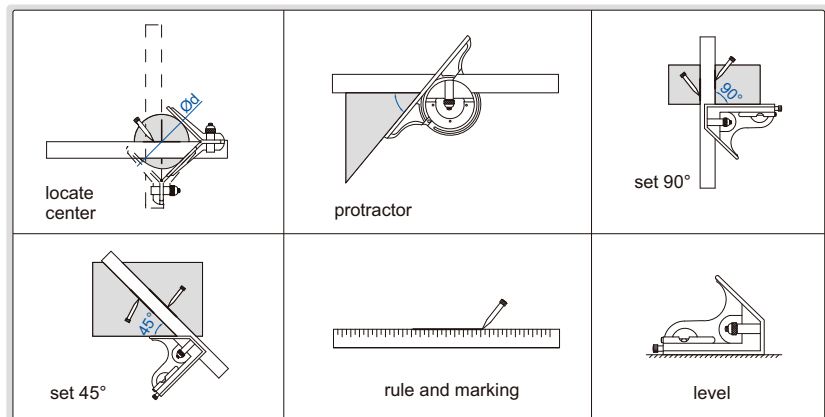
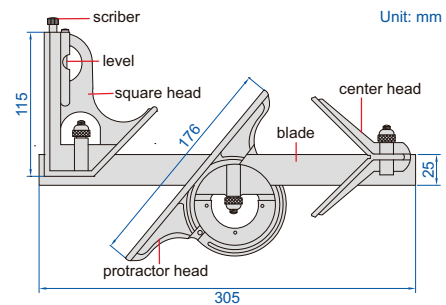

Code	Remark
2278-2	2-piece set
2278-3	3-piece set
2278-180	4-piece set

COMBINATION SQUARE SET (OPEN TYPE PROTRACTOR)

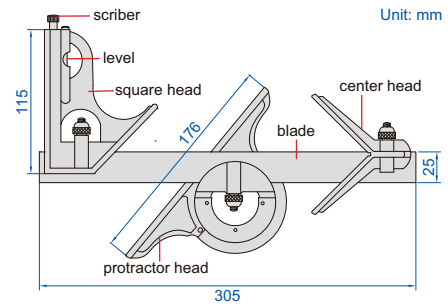
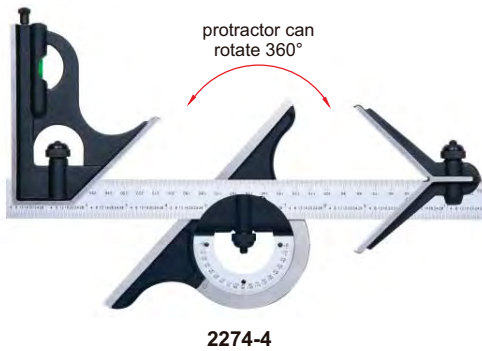

- Center head (made of cast iron):
to locate center of cylinders with diameter (\varnothing): 30-100mm
accuracy: ± 0.15 mm
- Protractor head (made of cast iron):
set the blade at desired angle to an edge of a workpiece, and can be used to measure angles
range: 0-180°
accuracy: ± 20 min
- Square head (made of cast iron):
set the blade at 90° or 45° to an edge of a workpiece
accuracy: ± 8 min for 90° square,
 ± 10 min for 45° square
- Blade (made of stainless steel):
range: 300mm/12",
graduation: 0.5mm and 1/32" on front face,
1mm and 1/64" on back face
- Optional accessory: rigid rule (code 7113)

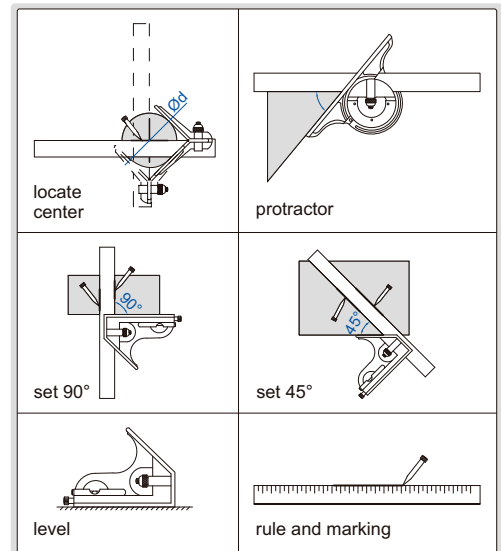

Code	Remark
2274-4	4-piece set

T-BEVEL

blade can rotate 360°

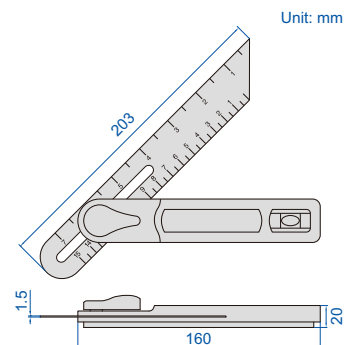
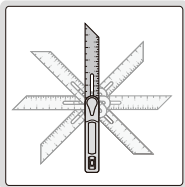

- Easy-to-read vial
- The blade can move and can be locked by the clamping screw
- Stainless steel blade
- Tough rubber handle
- Centimeter/inch graduations

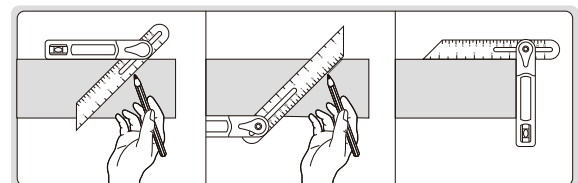

Code	Angle mark	Accuracy of angle
2281-360	15°, 30°, 45°, 60°, 90°	$\pm 1^\circ$

PLASTIC ANGLE SQUARE

- Length range: 0-7", graduation: 1/8"
- Angel range: 0-90°, graduation: 1°

Code	Size (L×W)	Accuracy of angle
2282-180	180×185mm	±0.3°



2282-180

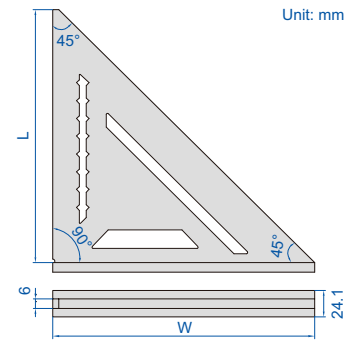

MARKING GAGES

- Made of carbon steel
- Satin chrome plated



7120-200A

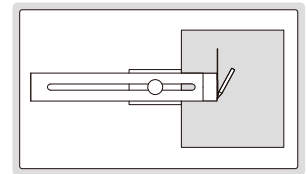

Code	Range	Graduation	Accuracy	L	W
7120-200A	0-200mm	0.1mm	±0.1mm	250mm	40mm
7120-250A	0-250mm	0.1mm	±0.1mm	300mm	40mm
7120-300A	0-300mm	0.1mm	±0.1mm	350mm	40mm

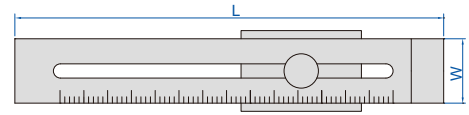

16

T-SHAPE MARKING GAGE

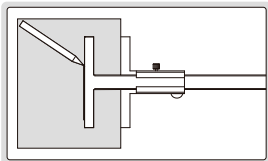

1275-150B

- Made of stainless steel
- Satin chrome plated reading surface

Code	Range	Graduation	Accuracy
1275-150B	0-150mm	0.02mm	±0.04mm

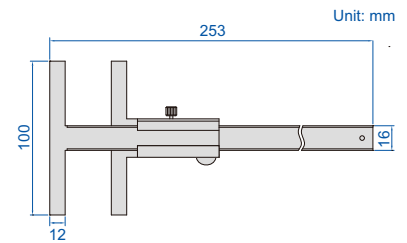

CENTER MARKING GAGES

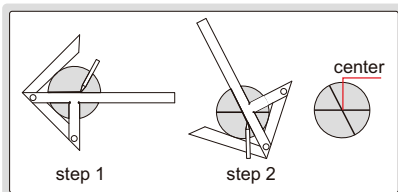

7205-100

Code	Size (AxB)	Diameter of shafts (Ød)	Accuracy	C	L
7205-100	100x70mm	4-90mm	±0.15mm	12mm	153mm
7205-150	150x130mm	4-190mm	±0.15mm	15mm	245mm
7205-200	200x150mm	6-220mm	±0.15mm	15mm	310mm
7205-300	300x180mm	6-270mm	±0.15mm	20mm	435mm

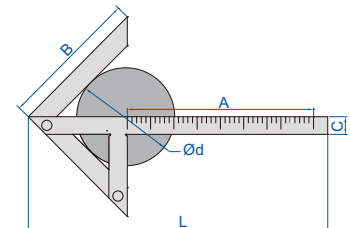

- Marking the center of round plates and shafts
- Made of stainless steel
- Satin chrome plated

SCRIBING CALIPER

- Made of stainless steel
- Satin chrome plated reading surface
- Carbide scriber tip
- Optional accessory: carbide scriber tip (code **SP-SCRIBER-7202**)

the position of scriber tip can be adjusted

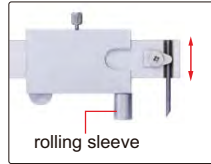

7202-200A

Code	Range	Graduation	Accuracy
7202-200A	0-200mm/0-8"	0.1mm, 1/128"	±0.1mm

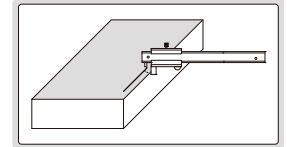
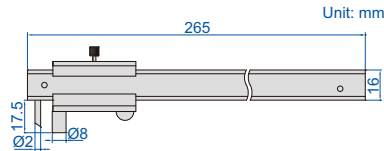

DIGITAL SCRIBING CALIPERS

- Non waterproof
- The carbide-tipped jaws facilitate scribing on workpieces
- Resolution: 0.01mm/0.0005"
- Buttons: on/off, zero, mm/inch
- Automatic power off, move the digital unit to turn on power
- Battery CR2032
- Made of stainless steel

DATA OUTPUT



carbide measuring faces

1166-150A

With data interface (data output cable code 7315-21 page 4, 7302-21 page 12, optional)

Code	Range	Accuracy
1166-150A	0-150mm/0-6"	±0.03mm

Built-in wireless (receiver code 7315-2/3/6/7/8/9 is required)

Code	Range	Accuracy
1166-150AWL	0-150mm/0-6"	±0.03mm

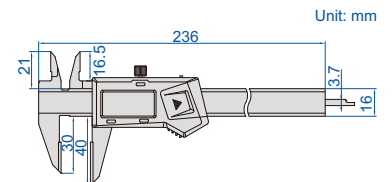
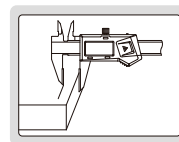

SCRIBING CALIPER

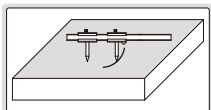

- Made of stainless steel
- Satin chrome plated reading surface
- Hardened scriber tips



7203-300A

Code	Range	Graduation	Accuracy
7203-300A	51-300mm	0.1mm	±0.1mm

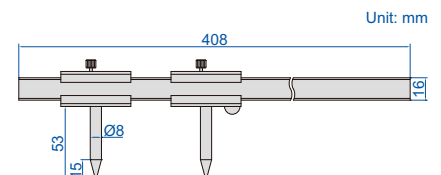

HEIGHT SCRIBER

- Grooved bottom for cylinders
- Two pins to be set against the edge of surface plate

Code

6990-300A

6990-300A

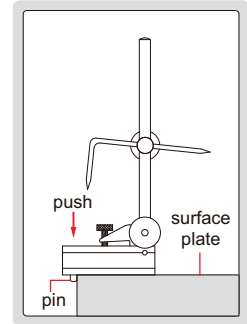
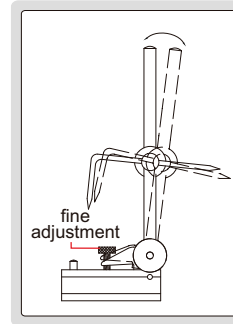
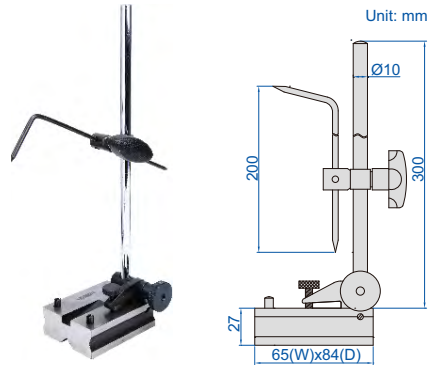

SCRIBERS

- 7230 and 7231 are nickel plated, 7232 is zinc-plated

Code

Tip

7230 hardened tips

7231 hardened tip

7232 carbide tip

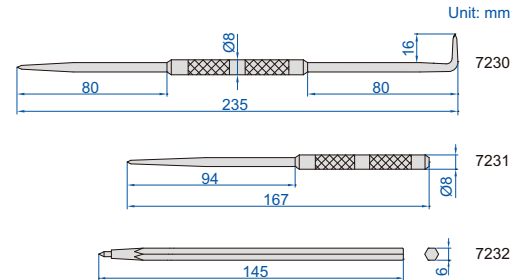

16

PRECISION SCREWDRIVER SET CODE ISGF-0901

- Includes:
 - 4 pcs "-": 1.4mm, 2.0mm, 2.4mm, 3.0mm
 - 2 pcs "+": 0#, 1#
- Rotating cap
- Material: CRV, hardness: HRC52~56



ISGF-0901

packaging



LED FLASHLIGHT CODE ISGF-0501

- Toshiba high performance LED
- Powered by 3x AAA batteries (batteries are not included)
- Max output: 120 lumens
- Battery life: 4 hours
- Beam distance: 70 meters
- IP54 dust/waterproof



ISGF-0501

packaging



MEASURING TOOLS REPAIR TOOL SET

- For repairing of calipers, micrometers and indicators
- Including:
 - 1) Slotted screwdriver, 1.4×20mm
 - 2) Slotted screwdriver, 2.0×20mm
 - 3) Slotted screwdriver, 2.4×25mm
 - 4) Slotted screwdriver, 3.0×25mm
 - 5) Cross screwdriver, 0#×25mm
 - 6) Cross screwdriver, 1#×25mm
 - 7) Magnetizer and demagnetizer
 - 8) Pointed tweezers, 125mm
 - 9) Mini needle-nose pliers, 5"
 - 10) Extended flat head allen wrench, 1.5×80mm
 - 11) Extended flat head allen wrench, 2.5×94mm
 - 12) Extended flat head allen wrench, 3×92mm
 - 13) Needle puller, 3 pcs
 - 14) Copper hammer, 126g
 - 15) Copper rod, Ø10×60mm
 - 16) Dial face suction cup, Ø30mm
 - 17) Oil stone, 100×20×10mm
 - 18) Cleaning brush
 - 19) Micrometer wrench
 - 20) Three point inside micrometer rod wrench, 2 pcs
 - 21) Anti rust oil, 30ml
 - 22) Special anti rust oil for micrometers, 30ml
 - 23) Dust free cloth, 5 pcs



7338-1

Code

7338-1

2-PIECE MEASURING TOOL SETS

- Includes:
 - 1) Vernier caliper, range 0-150mm/0-6", graduation 0.05mm/1/128" (code **1205-150S**) for **5021**, graduation 0.02mm/0.001" (code **1205-1502S**) for **5021-2**
 - 2) Outside micrometer, range 0-25mm, graduation 0.01mm (code **3202-25A**)

Code	Remark
5021	vernier caliper, graduation 0.05mm/1/128" (code 1205-150S)
5021-2	vernier caliper, graduation 0.02mm/0.001" (code 1205-1502S)



5021

2-PIECE MEASURING TOOL SETS

- Includes:
 - 1) Digital caliper, range 0-150mm/0-6", resolution 0.01mm/0.0005", with thumb roller (code **1108-150**) for **5022**, without thumb roller (code **1108-150W**) for **5022-W**
 - 2) Digital outside micrometer, range 0-25mm/0-1", resolution 0.001mm/0.00005" (code **3109-25A**)

Code	Remark
5022	digital caliper, with thumb roller, code 1108-150
5022-W	digital caliper, without thumb roller, code 1108-150W



5022

2-PIECE MEASURING TOOL SET

- Includes:
 - 1) Dial test indicator, range 0.8mm, graduation 0.01mm (code **2380-08**)
 - 2) Magnetic stand

Code

5023



5023

2-PIECE MEASURING TOOL SET

- Includes:
 - 1) Dial indicator, range 10mm, graduation 0.01mm (code **2308-10A**)
 - 2) Magnetic stand (code **6201-60**)

Code

5024



5024

16

3-PIECE MEASURING TOOL SET

- Includes:
 - 1) Digital indicator, range 12.7mm/0.5", resolution 0.01mm/0.0005" (code **2112-10**)
 - 2) Flex arm
 - 3) Locking pliers, adjustable jaw opening from 0 to 25mm



Code

5031



5031

3-PIECE MEASURING TOOL SET

- Includes:
 - 1) Vernier caliper, range 0-150mm graduation 0.02mm (code **1205-1501S**)
 - 2) Outside micrometer, range 0-25mm, graduation 0.01mm (code **3203-25A**)
 - 3) Steel rule, range 150mm/6", graduation 0.5mm, 1mm, 1/64", 1/32", 1/16" (code **7110-150**)
 - 4) Dust free gloves and dust free cloth

dust free gloves and
dust free cloth



Code

5032



5032

4-PIECE MEASURING TOOL SETS

- Includes:
 - 1) Vernier caliper, range 0-150mm/0-6", graduation 0.05mm/1/128" (code **1205-150S**) for **5041**, graduation 0.02mm/0.001" (code **1205-1502S**) for **5041-2**
 - 2) Outside micrometer, range 0-25mm, graduation 0.01mm (code **3202-25A**)
 - 3) 90° beveled edge square, 100x70mm, grade 0 (code **4790-1000**)
 - 4) Steel rule, 150mm/6" (code **7110-150**)



5041

Code	Remark
5041	vernier caliper, graduation 0.05mm/1/128" (code 1205-150S)
5041-2	vernier caliper, graduation 0.02mm/0.001" (code 1205-1502S)

4-PIECE MEASURING TOOL SETS

- Includes:
 - 1) Digital caliper, range 0-150mm/0-6", resolution 0.01mm/0.0005", with thumb roller (code **1108-150**) for **5042**, without thumb roller (code **1108-150W**) for **5042-W**
 - 2) Outside micrometer, range 0-25mm, graduation 0.01mm, (code **3202-25A**)
 - 3) 90° beveled edge square, 100x70mm, grade 0 (code **4790-1000**)
 - 4) Steel rule, 150mm/6" (code **7110-150**)



5042

Code	Remark
5042	digital caliper, with thumb roller, code 1108-150
5042-W	digital caliper, without thumb roller, code 1108-150W

5-PIECE MEASURING TOOL SETS

- Includes:
 - 1) Digital caliper, range 0-150mm/0-6", resolution 0.01mm/0.0005", with thumb roller (code **1108-150**) for **5051**, without thumb roller (code **1108-150W**) for **5051-W**
 - 2) Outside micrometer, range 0-25mm, graduation 0.01mm (code **3203-25A**)
 - 3) Dial indicator, range 10mm, graduation 0.01mm (code **2308-10A**)
 - 4) Magnetic stand (code **6201-60**)
 - 5) Micrometer stand (code **6300**)



5051

Code	Remark
5051	digital caliper, with thumb roller, code 1108-150
5051-W	digital caliper, without thumb roller, code 1108-150W

5-PIECE MEASURING TOOL SETS

Includes:

- 1) Digital caliper, range 0-150mm/0-6", resolution 0.01mm/0.0005", with thumb roller (code **1108-150**) for **5052**, without thumb roller (code **1108-150W**) for **5052-W**
- 2) Digital outside micrometer, range 0-25mm/0-1", resolution 0.001mm/0.00005" (code **3109-25A**)
- 3) Digital indicator, range 12.7mm/0.5", resolution 0.01mm/0.0005" (code **2112-10**)
- 4) Magnetic stand (code **6201-60**)
- 5) Micrometer stand (code **6300**)

Code	Remark
5052	digital caliper, with thumb roller, code 1108-150
5052-W	digital caliper, without thumb roller, code 1108-150W



5052

6-PIECE MEASURING TOOL SETS

Includes:

- 1) Digital caliper, range 0-150mm/0-6", resolution 0.01mm/0.0005", with thumb roller (code **1108-150**) for **5061**, without thumb roller (code **1108-150W**) for **5061-W**
- 2) Outside micrometer, range 0-25mm, graduation 0.01mm (code **3202-25A**)
- 3) Dial indicator, range 10mm, graduation 0.01mm (code **2308-10FA**)
- 4) 90° beveled edge square, 100x70mm, grade 0 (code **4790-1000**)
- 5) Scriber (code **7230**)
- 6) Steel rule, 150mm/6" (code **7110-150**)

Code	Remark
5061	digital caliper, with thumb roller, code 1108-150
5061-W	digital caliper, without thumb roller, code 1108-150W



5061

6-PIECE MEASURING TOOL SETS

Includes:

- 1) Digital caliper, range 0-150mm/0-6" resolution 0.01mm/0.0005", with thumb roller (code **1108-150**) for **5062**, without thumb roller (code **1108-150W**) for **5062-W**
- 2) Outside micrometer, range 0-25mm graduation 0.01mm (code **3202-25A**)
- 3) 90° beveled edge square, 100x70mm grade 00 (code **4790-0100**)
- 4) Straight edge, 100mm (code **4700-100**)
- 5) Spring divider, 150mm (code **7260-150**)
- 6) Steel rule, 200mm/8" (code **7110-200**)

Code	Remark
5062	digital caliper, with thumb roller, code 1108-150
5062-W	digital caliper, without thumb roller, code 1108-150W



5062

6-PIECE MEASURING TOOL SETS

- Includes:
 - 1) Vernier caliper, range 0-150mm/0-6", graduation 0.05mm/1/128" (code **1205-150S**) for **5063**, graduation 0.02mm/0.001" (code **1205-1502S**) for **5063-2**
 - 2) Outside micrometer, range 0-25mm graduation 0.01mm (code **3202-25A**)
 - 3) 90° beveled edge square, 100x70mm grade 00 (code **4790-0100**)
 - 4) Straight edge, 100mm (code **4700-100**)
 - 5) Spring divider, 150mm (code **7260-150**)
 - 6) Steel rule, 200mm/8" (code **7110-200**)

Code	Remark
5063	vernier caliper, graduation 0.05mm/1/128" (code 1205-150S)
5063-2	vernier caliper, graduation 0.02mm/0.001" (code 1205-1502S)



5063

9-PIECE MEASURING TOOL SETS

- Includes:
 - 1) Digital caliper, range 0-150mm/0-6", resolution 0.01mm/0.0005", with thumb roller (code **1108-150**) for **5091**, without thumb roller (code **1108-150W**) for **5091-W**
 - 2) Outside micrometer, range 0-25mm, graduation 0.01mm (code **3202-25A**)
 - 3) Protractor, range 0-180°, graduation 1° (code **4799-180**)
 - 4) Pitch gauge, range 0.25-7mm, 24pcs, metric 60° thread (code **4820-124**)
 - 5) Radius gauge, range 1-7mm (code **4801-17**)
 - 6) Feeler gauge, range 0.05-1.00mm, 20pcs (code **4602-20**)
 - 7) 90° beveled edge square, 100x70mm, grade 0 (code **4790-1000**)
 - 8) Scriber (code **7230**)
 - 9) Steel rule, 150mm/6" (code **7110-150**)

Code	Remark
5091	digital caliper, with thumb roller, code 1108-150
5091-W	digital caliper, without thumb roller, code 1108-150W



5091

13-PIECE MEASURING TOOL SETS

- Includes:
 - 1) Digital caliper, range 0-150mm/0-6", resolution 0.01mm/0.0005", with thumb roller (code **1108-150**) for **5013**, without thumb roller (code **1108-150W**) for **5013-W**
 - 2) Outside micrometer, range 0-25mm, graduation 0.01mm (code **3202-25A**)
 - 3) Dial indicator, range 10mm, graduation 0.01mm (code **2308-10A**)
 - 4) Magnetic stand (code **6201-60**)
 - 5) Protractor, range 0-180°, graduation 1° (code **4799-180**)
 - 6) Pitch gauge, range 0.25-7mm, 24pcs, metric 60° thread (code **4820-124**)
 - 7) Radius gauge, range 1-7mm (code **4801-17**)
 - 8) Feeler gauge, range 0.05-1.00mm, 20pcs (code **4602-20**)
 - 9) 90° beveled edge square, 100x70mm, grade 0 (code **4790-1000**)
 - 10) Scriber (code **7230**)
 - 11) Steel rule, 150mm/6" (code **7110-150**)
 - 12) Depth base attachment (code **6140**)
 - 13) Zero setting bar for depth base attachment

Code	Remark
5013	digital caliper, with thumb roller, code 1108-150
5013-W	digital caliper, without thumb roller, code 1108-150W



5013



Granite Surface Plates
Page 402



Jack Sets For Granite Surface Plates
Page 403



Stands For Granite Surface Plates
Page 403



Magnetic Rectangular Blocks
Page 404



V-blocks
Page 404-408



Magnetic V-blocks
Page 408-410



Magnetic Induction V-blocks
Page 410



Squares With V Groove
Page 411



Permanent Magnetic Chucks
Page 411



Parallels
Page 412-414



Parallel/Square Sets
Page 415



Magnetic Induction Parallel Sets
Page 415



Angle Plate Sets
Page 415-416



Adjustable Angle Blocks
Page 416



Right Angle Plates
Page 416-417



Sine Bars
Page 417-418



Sine Tables
Page 418-419



Precision Sine Vises
Page 419-420



Precision Universal Vises
Page 420



Precision Vises
Page 421

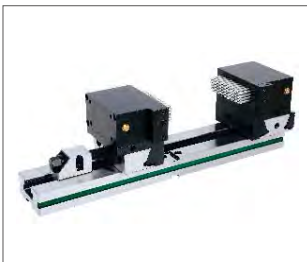

Anvil Vises
Page 421



Stages
Page 422-425

GRANITE SURFACE PLATES



CUSTOM-MADE
SUPPLY SPECIAL SIZES ACCORDING
TO CUSTOMER'S REQUEST

- Made of Indian granite, high hardness, free from deterioration or dimensional change over time, minimal changes in dimension due to temperature changes
- Meet DIN876, grade 00 is for inspection room or lab, grade 0 is for workshop
- Optional accessory:
stand for granite surface plate (code **6902**),
jack for granite surface plate (code **6903**)



6900-132

Grade 00

Code	Size (LxWxH)	Flatness	Weight	Max. load
6900-132*	300x200x60mm	2.7µm	11kg	30kg
6900-142*	400x250x60mm	2.9µm	18kg	50kg
6900-144*	400x400x60mm	3.1µm	29kg	60kg
6900-153*	500x315x70mm	3.2µm	33kg	60kg
6900-164*	630x400x80mm	3.5µm	60kg	65kg
6900-166*	630x630x100mm	3.8µm	119kg	75kg
6900-185*	800x500x100mm	3.9µm	120kg	100kg
6900-1106*	1000x630x140mm	4.4µm	265kg	200kg
6900-1107*	1000x750x150mm	4.5µm	337kg	300kg
6900-1101*	1000x1000x150mm	4.8µm	450kg	400kg
6900-1128*	1200x800x160mm	4.9µm	461kg	500kg
6900-1161*	1600x1000x180mm	5.8µm	864kg	600kg
6900-1201*	2000x1000x220mm	6.5µm	1320kg	650kg
6900-1202*	2000x1500x250mm	7.0µm	2250kg	750kg



Grade 0

Code	Size (LxWxH)	Flatness	Weight	Max. load
6900-032*	300x200x60mm	5.4µm	11kg	60kg
6900-042*	400x250x60mm	5.9µm	18kg	100kg
6900-044*	400x400x60mm	6.3µm	29kg	120kg
6900-053*	500x315x70mm	6.4µm	33kg	120kg
6900-064*	630x400x80mm	7.0µm	60kg	130kg
6900-066*	630x630x100mm	7.6µm	119kg	150kg
6900-085*	800x500x100mm	7.8µm	120kg	200kg
6900-0106*	1000x630x140mm	8.7µm	265kg	400kg
6900-0107*	1000x750x150mm	9.0µm	337kg	600kg
6900-0101*	1000x1000x150mm	9.7µm	450kg	800kg
6900-0128*	1200x800x160mm	9.8µm	461kg	1000kg
6900-0161*	1600x1000x180mm	11.5µm	864kg	1200kg
6900-0201*	2000x1000x220mm	12.9µm	1320kg	1300kg
6900-0202*	2000x1500x250mm	14.0µm	2250kg	1500kg

*Supplied with manufacturer inspection certificate

JACK SET FOR GRANITE SURFACE PLATES

- 5 jacks per set
- Adjustable height
- For large granite surface plates:
2000x1000x220mm
(code **6900-0201** and **6900-1201**)
2000x1500x250mm
(code **6900-0202** and **6900-1202**)

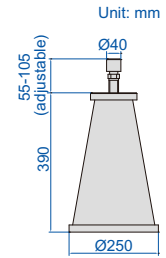

6903-B

Code

6903-B

STANDS FOR GRANITE SURFACE PLATES

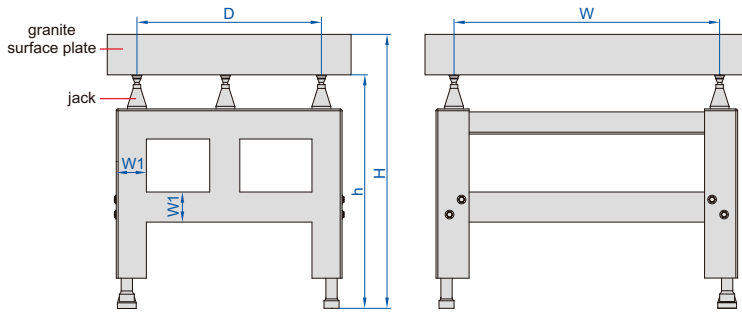

adjustable foot

6902-64A

- For medium size granite surface plates
- 5 jacks are included
- Adjusting range of jacks: 25mm
- One foot on the bottom is adjustable

Low stands

(mm)

Code	For granite surface plate	W	D	H (with granite surface plate)	h (without granite surface plate)	W1
6902-64A	630x400x80mm (code 6900-064 and 6900-164)	352	224	775-800	695-720	80
6902-66A	630x630x100mm (code 6900-066 and 6900-166)	352	352	775-800	675-700	80
6902-85A	800x500x100mm (code 6900-085 and 6900-185)	448	280	775-800	675-700	80
6902-106A	1000x630x140mm (code 6900-0106 and 6900-1106)	560	352	755-780	615-640	80
6902-107A	1000x750x150mm (code 6900-0107 and 6900-1107)	560	420	755-780	605-630	80
6902-101A	1000x1000x150mm (code 6900-0101 and 6900-1101)	560	560	755-780	605-630	80
6902-128A	1200x800x160mm (code 6900-0128 and 6900-1128)	672	448	755-780	595-620	80
6902-161A	1600x1000x180mm (code 6900-0161 and 6900-1161)	896	560	755-780	575-600	80
6902-201A	2000x1000x220mm (code 6900-0201 and 6900-1201)	1120	560	755-780	535-560	100
6902-202A	2000x1500x250mm (code 6900-0202 and 6900-1202)	1120	840	755-780	505-530	100

High stands

(mm)

Code	For granite surface plate	W	D	H (with granite surface plate)	h (without granite surface plate)	W1
6902-64H	630x400x80mm (code 6900-064 and 6900-164)	352	224	1000-1025	920-945	80
6902-66H	630x630x100mm (code 6900-066 and 6900-166)	352	352	1000-1025	900-925	80
6902-85H	800x500x100mm (code 6900-085 and 6900-185)	448	280	1000-1025	900-925	80
6902-106H	1000x630x140mm (code 6900-0106 and 6900-1106)	560	352	1000-1025	860-885	80
6902-107H	1000x750x150mm (code 6900-0107 and 6900-1107)	560	420	1000-1025	850-875	80
6902-101H	1000x1000x150mm (code 6900-0101 and 6900-1101)	560	560	1000-1025	850-875	80
6902-128H	1200x800x160mm (code 6900-0128 and 6900-1128)	672	448	1000-1025	840-865	80
6902-161H	1600x1000x180mm (code 6900-0161 and 6900-1161)	896	560	1000-1025	820-845	80
6902-201H	2000x1000x220mm (code 6900-0201 and 6900-1201)	1120	560	1000-1025	780-805	100
6902-202H	2000x1500x250mm (code 6900-0202 and 6900-1202)	1120	840	1000-1025	750-775	100

MAGNETIC RECTANGULAR BLOCKS

HARDENED SURFACES

HIGH PRECISION

STRONG MAGNETIC FORCE

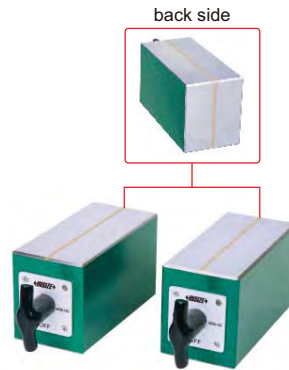
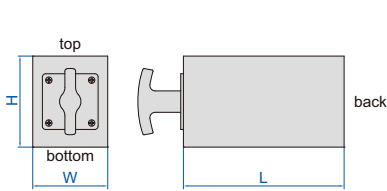

6898-150

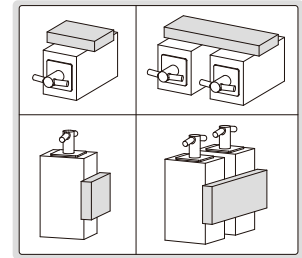

- For grinding, light milling, drilling and inspection of round and square jobs
- Hardened, high accuracy, strong magnetic force
- Working surfaces are hardened to HRC58-62
- Magnetic force on top, bottom and back sides
- Supplied in matched pair

Code	Size (LxWxH)	Magnetic force	Parallelism of top to bottom side	Squareness of top and bottom to back side	Height difference of a matched pair
6898-100	100x70x70mm	100kgf	5µm	5µm	5µm
6898-150	150x70x85mm	125kgf	5µm	5µm	5µm

17

V-BLOCK SETS



6896-10

6896-11

- Hold cylindrical workpieces for inspection and machining
- Two V-blocks per set
- Made of alloy steel
- Hardened to HRC60±2
- V groove on the top for large shafts
- V groove on the bottom for small shafts (except 6896-10)

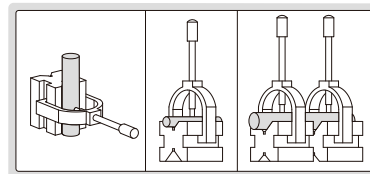

Code	Size (LxWxH)	Range of shafts (Ød)	Parallelism of both V grooves to top and bottom sides	Squareness of both V grooves to front and back sides	Height difference of a matched pair
6896-10	25x20x20mm	3-20mm	3µm	3µm	3µm
6896-11	50x40x40mm	5-30mm	5µm	5µm	5µm
6896-12	80x63x63mm	7-63mm	5µm	5µm	5µm
6896-13	100x80x80mm	7-80mm	5µm	5µm	5µm
6896-14	70x140x140mm	9-140mm	5µm	5µm	5µm

SIDE LIE-DOWN
USE IS POSSIBLE

V-BLOCK SET



6802-1

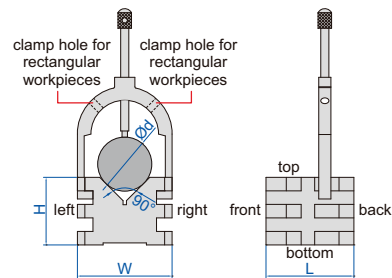

- Hold cylindrical or rectangular workpieces for inspection and machining
- Two V-blocks per set
- Made of alloy steel
- Hardened to HRC60±2
- Applicable for cylinder with diameter (Ød): 5-50mm
- Applicable for rectangular workpieces with thickness: ≤35mm

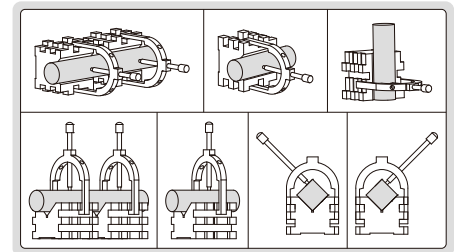

Code	Size (LxWxH)	Parallelism of V groove to top, bottom, left, right sides	Squareness of V groove to front and back sides	Height difference of a matched pair
6802-1	65x70x50mm	5µm	5µm	5µm

SIDE LIE-DOWN
USE IS POSSIBLE

V-BLOCK SETS



6803-1

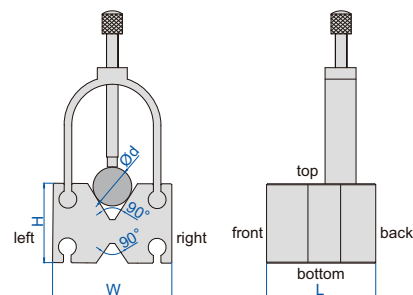

- Hold cylindrical workpieces for inspection and machining
- Two V-blocks per set
- Made of alloy steel
- Hardened to HRC60±2
- V groove on the top for large shafts
- V groove on the bottom for small shafts

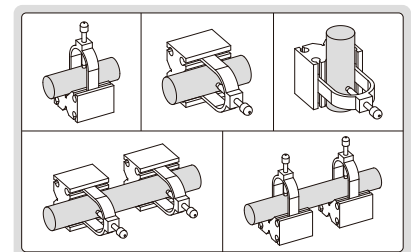

Code	Size (LxWxH)	Range of shafts (Ød)	Parallelism of both V grooves to top, bottom, left, right sides	Squareness of both V grooves to front and back sides	Height difference of a matched pair
6803-1	55x60x40mm	4-35mm	5µm	5µm	5µm
6803-2	65x70x45mm	4-47mm	5µm	5µm	5µm

V-BLOCK SET

SIDE LIE-DOWN
USE IS POSSIBLE



6806-20

- Hold cylindrical workpieces for inspection and machining
- Two V-blocks per set
- Made of alloy steel
- Hardened to HRC60±2
- Applicable for cylinder with diameter (Ød): 2-20mm

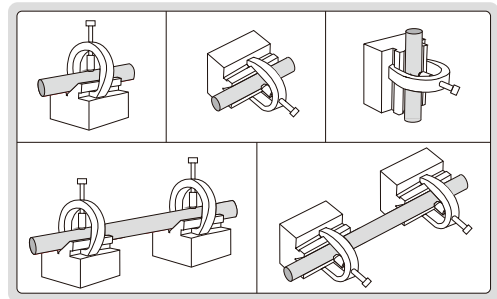
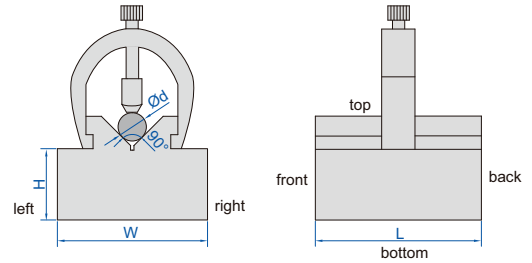

Code	Size (LxWxH)	Parallelism of V groove to bottom, left, right sides	Squareness of V groove to front and back sides	Height difference of a matched pair
6806-20	70x63x46mm	5µm	5µm	5µm

17

V-BLOCK

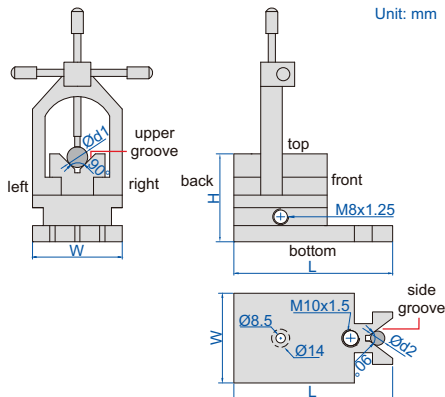

6804-M2

- Hold cylindrical workpieces for inspection and machining
- Made of alloy steel
- Hardened to HRC60±2

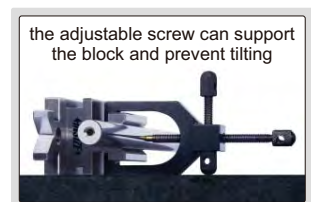

Code	Size (LxWxH)	Range of shafts (Ød1 and Ød2)	Parallelism of upper groove to bottom, left and right sides	Squareness of upper groove to back side	Parallelism of side groove to back side
6804-M2	90x48x48mm	5-33mm	5µm	5µm	5µm

V-BLOCK SETS

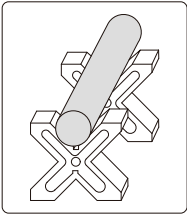

- For positioning cylindrical workpieces
- Two V-blocks per set
- Each V-block has four 90° V-grooves
- Cast iron, hardness HB170-240

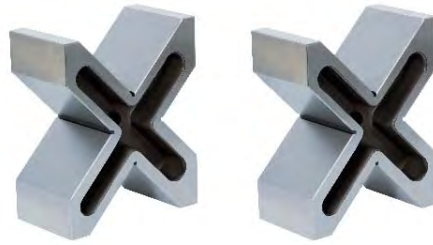

6805-2

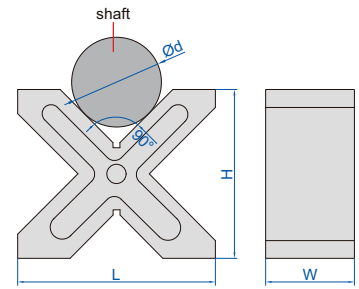

Code	Size (L×H×W)	Range of shafts (Ød)	Parallelism of four V grooves to all sides	Height difference of a matched pair
6805-1	150×130×75mm	8-120mm	15µm	20µm
6805-2	200×170×90mm	12-180mm	15µm	20µm

V-BLOCK SETS

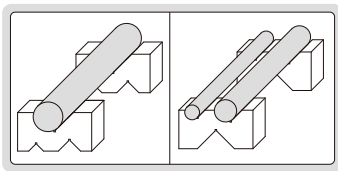

- Two V-blocks per set
- Made of hardened tool steel



6887-3

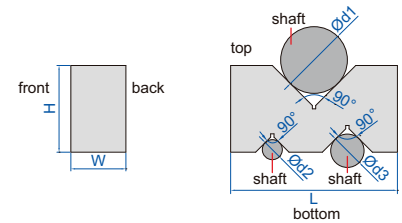

Code	Size (LxWxH)	Range of shafts (Ød1)	Range of shafts (Ød2)	Range of shafts (Ød3)
6887-1	50x19x24mm	3-32mm	3-16mm	3-22mm
6887-2	75x24x35mm	3-50mm	3-20mm	3-32mm
6887-3	100x33x52mm	3-68mm	3-26mm	3-40mm
6887-4	125x44x69mm	3-87mm	3-34mm	3-50mm

Code	Parallelism of three V grooves to top and bottom sides	Height difference of a matched pair
6887-1	5µm	5µm
6887-2	5µm	5µm
6887-3	5µm	5µm
6887-4	5µm	5µm

ROLLER BEARING V-BLOCK SETS

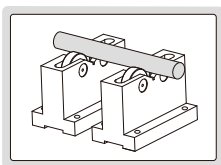

- Runout accuracy: 5µm
- Parallelism of bearings to bottom: 12µm
- Two V-blocks per set
- Workpieces don't get damaged due to bearings
- Suitable for heavy workpieces



6888-1

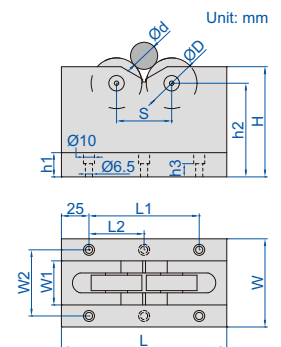

Code	Size (LxWxH)	Code of bearings	Diameter of bearings (ØD)	Range of shafts (Ød)	Load capacity
6888-1	150x60x100mm	16004 ZZ	42mm	25-70mm	500kg
6888-2	150x80x100mm	6303 ZZ	47mm	5-55mm	1000kg
6888-3	230x100x150mm	6306 ZZ	72mm	70-200mm	1000kg

Code	W1	W2	h1	h2	h3	L1	L2	S
6888-1	22	44	20	85	12	100	-	60
6888-2	40	60	22	85	12	100	-	50
6888-3	60	80	30	124	20	180	90	120

GRANITE V-BLOCK SETS

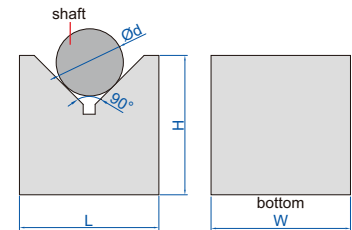
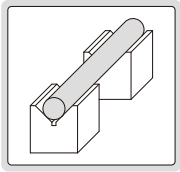

■ Two V-blocks per set

6897-1

Code	Size (LxWxH)	Range of shafts (Ød)	Parallelism of V groove to bottom	Height difference of a matchet pair
6897-1	70x50x70mm	6-75mm	4µm	5µm
6897-2	100x50x70mm	6-84mm	4µm	5µm

MAGNETIC V-BLOCKS (PROFESSIONAL TYPE)

HARDENED SURFACES

HIGH PRECISION

STRONG MAGNETIC FORCE

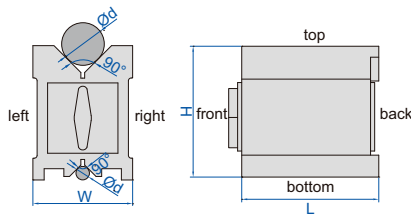

6889-11

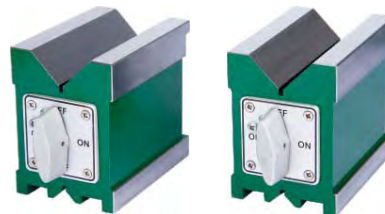

6889-1

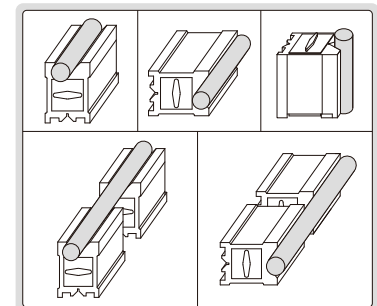

- Hardened, high accuracy, strong magnetic force, for grinding, light milling, drilling and inspection of round and square workpieces
- All working surfaces are hardened to HRC60±2
- Magnetic force on top, bottom and two V grooves
- V groove on the top for large shafts
- V groove on the bottom for small shafts
- Suitable for cast iron surface plates and granite surface plates

Individual

Code	Size (LxWxH)	Range of shafts (Ød)	Magnetic force	Parallelism of V grooves to top, bottom, left, right sides	Squareness of V grooves to back side
6889-11	75x56x75mm	5-40mm	85kgf	5µm	5µm
6889-22	100x70x95mm	5-65mm	150kgf	5µm	5µm
6889-33	150x75x100mm	5-70mm	190kgf	6µm	6µm
6889-55	160x125x130mm	5-140mm	220kgf	12µm	12µm
6889-44	200x125x150mm	10-140mm	400kgf	12µm	12µm

Matched pair

Code	Size (LxWxH)	Range of shafts (Ød)	Magnetic force	Parallelism of V grooves to top, bottom, left, right sides	Squareness of V grooves to back side	Height difference of a matched pair
6889-1	75x56x75mm	5-40mm	85kgf	5µm	5µm	5µm
6889-2	100x70x95mm	5-65mm	150kgf	5µm	5µm	5µm
6889-3	150x75x100mm	5-70mm	190kgf	6µm	6µm	6µm
6889-5	160x125x130mm	5-140mm	220kgf	12µm	12µm	12µm
6889-4	200x125x150mm	10-140mm	400kgf	12µm	12µm	12µm

ATTENTION: NOT SUITABLE FOR STEEL OR IRON SURFACES, OTHERWISE THE MAGNETIC FORCE WILL BE REDUCED

ATTENTION: NOT HARDENED

MAGNETIC V-BLOCK (ECONOMIC TYPE)

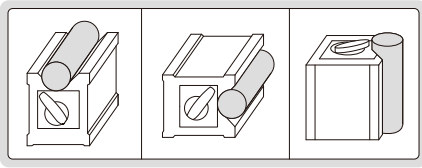

6890-702

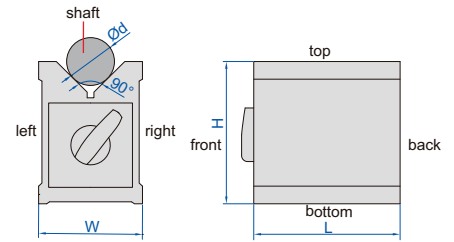

- Hold cylindrical workpieces for inspection and machining
- Supplied in single piece
- Not hardened
- Not suitable for steel or iron surfaces, otherwise the magnetic force will be reduced

Code	Size (LxWxH)	Range of shafts ($\varnothing d$)	Magnetic force	Parallelism of V groove to top, bottom, left and right sides	Squareness of V groove to back side
6890-702	70x60x73mm	6-44mm	56kgf	10 μ m	10 μ m

ATTENTION: NOT SUITABLE FOR STEEL OR IRON SURFACES, OTHERWISE THE MAGNETIC FORCE WILL BE REDUCED

ATTENTION: NOT HARDENED

MAGNETIC V-BLOCKS (ECONOMIC TYPE)

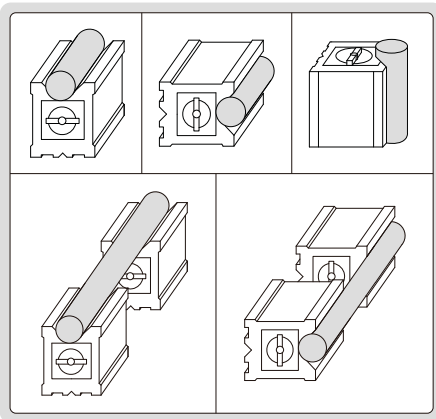

6801-1201



6801-1

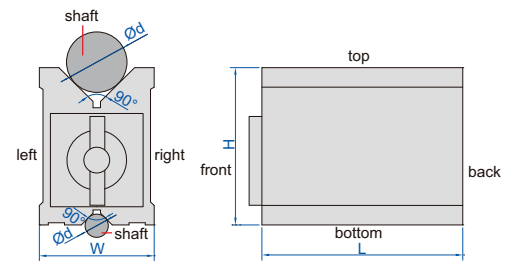

- Hold cylindrical workpieces for inspection and machining
- Not hardened
- V groove on the top for large shafts
- V groove on the bottom for small shafts
- Not suitable for steel or iron surfaces, otherwise the magnetic force will be reduced

Individual

Code	Size (LxWxH)	Range of shafts ($\varnothing d$)	Magnetic force	Parallelism of V grooves to top, bottom, left, right side	Squareness of V grooves to back side
6801-1201	80x70x95mm	6-67mm	64kgf	10 μ m	10 μ m
6801-1202	100x70x95mm	6-67mm	80kgf	10 μ m	10 μ m
6801-1203	120x70x95mm	6-67mm	96kgf	10 μ m	10 μ m

Matched pair

Code	Size (LxWxH)	Range of shafts ($\varnothing d$)	Magnetic force	Parallelism of V grooves to top, bottom, left, right side	Squareness of V grooves to back side	Height difference of a matched pair
6801-1	80x70x95mm	6-67mm	64kgf	10 μ m	10 μ m	10 μ m
6801-2	100x70x95mm	6-67mm	80kgf	10 μ m	10 μ m	10 μ m
6801-3	120x70x95mm	6-67mm	96kgf	10 μ m	10 μ m	10 μ m

MAGNETIC INDUCTION V-BLOCK SET

ATTENTION: NOT HARDENED, DO NOT ROTATE WORKPIECES ON V-BLOCKS

- Hold cylindrical workpieces for inspection and machining
- To be used on magnetic chucks
- Two V-blocks per set
- V groove on the top for large shafts
- V groove on the bottom for small shafts
- Hardness HRB70
- Copper magnetic strips

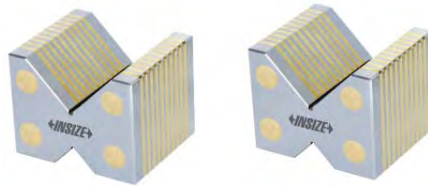

6878-1

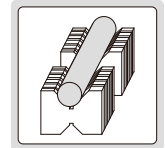
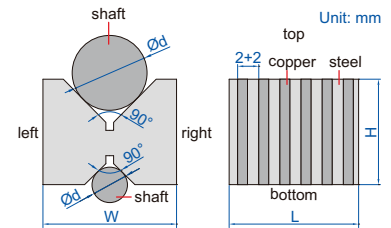

Code	Size (LxWxH)	Range of shafts ($\varnothing d$)	Pole pitch	Parallelism of both V grooves to top and bottom sides	Height difference of a matched pair
6878-1	49x58x46mm	5-56mm	2+2mm	10 μ m	10 μ m

MAGNETIC INDUCTION V-BLOCK

ATTENTION: NOT HARDENED, DO NOT ROTATE WORKPIECES ON V-BLOCKS

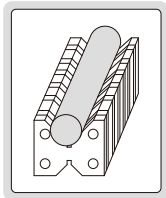

17

- Hold cylindrical workpieces for inspection and machining
- To be used on magnetic chucks
- Supplied in single piece
- V groove on the top for large shafts
- V groove on the bottom for small shafts
- Hardness HRB70



6892-1

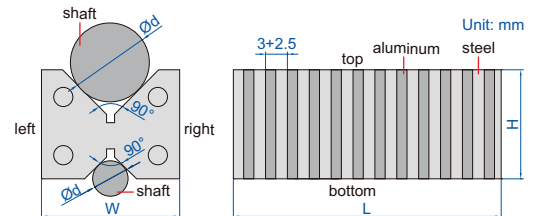

Code	Size (LxWxH)	Range of shafts ($\varnothing d$)	Pole pitch	Parallelism of both V grooves to top and bottom sides
6892-1	110x60x48mm	6-50mm	3+2.5mm	10 μ m

MAGNETIC V-BLOCK SETS

ATTENTION: NOT HARDENED, DO NOT ROTATE WORKPIECES ON V-BLOCKS

ATTENTION: LOW MAGNETIC FORCE

- Hold cylindrical workpieces for inspection, not suitable for machining due to low magnetic force
- Two V-blocks per set
- Hardness HRB70



6891-1

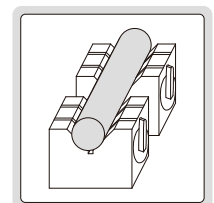
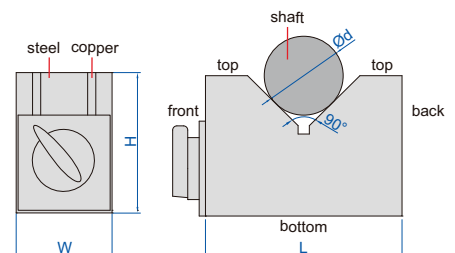

Code	Size (LxWxH)	Range of shafts ($\varnothing d$)	Magnetic force	Parallelism of V groove to bottom and back sides	Height difference of a matched pair
6891-1	70x40x50mm	6-46mm	15kgf	10 μ m	10 μ m
6891-3	150x50x100mm	6-125mm	21kgf	10 μ m	10 μ m

GRANITE SQUARE WITH V GROOVE



4142-200

- Parallelism and squareness of A, B, C, D, E and F: 6µm
- Parallelism and squareness of V groove to A, B, C, D, E and F: 6µm

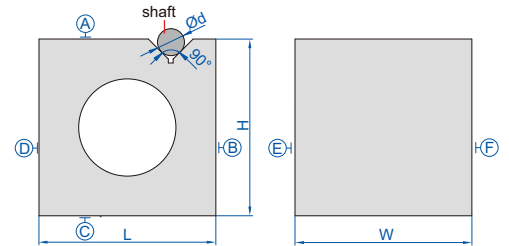

Code	Size (L×W×H)	Range of shaft (Ød)
4142-200	200×200×200mm	9~70mm

ATTENTION: NOT HARDENED, DO NOT ROTATE WORKPIECES ON V-BLOCKS

MAGNETIC SQUARE WITH V GROOVE



6539-100

- Hold flat and cylindrical workpieces for inspection and machining
- Magnetic force on top, left, right and V grooves
- Parallelism and squareness of top, bottom, left, right and back: 20µm
- Parallelism and squareness of V grooves to top, bottom, left, right and back: 20µm

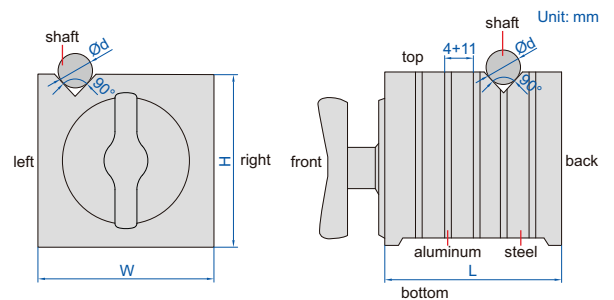

17

Code	Size (L×W×H)	Magnetic force of V grooves		Magnetic force of top, left and right sides		Range of shafts (Ød)
		on granite surface plate	on cast iron plate	on granite surface plate	on cast iron plate	
6539-100	100×100×100mm	30kgf	25kgf	50kgf	30kgf	5-30mm

ATTENTION: NOT HARDENED

PERMANENT MAGNETIC CHUCK



6537-400

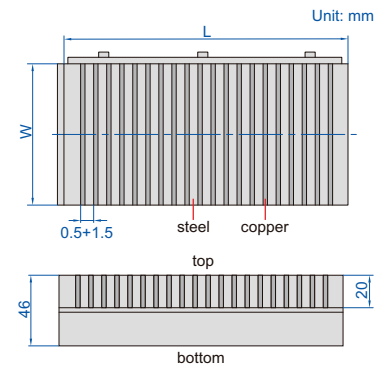

Code	Table size (L×W)	Magnetic force	Pole pitch	Parallelism of top to bottom
6537-400	400×200mm	8kgf/cm ²	0.5+1.5mm	0.02mm/300mm

PARALLELS

- Made of alloy tool steel
- Hardened to HRC55-60
- Supplied in pair

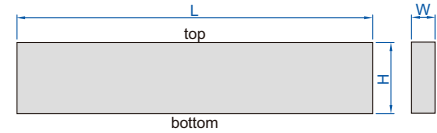

6512-2210A

L=125mm	L=150mm	L=200mm			
Code	Code	Code	H×W	Parallelism between top and bottom	Height difference of a matched pair
6512-118	6512-1181	6512-1182	11×8mm	5µm	5µm
6512-168	6512-1681	6512-1682	16×8mm	5µm	5µm
6512-218	6512-2181	6512-2182	21×8mm	5µm	5µm
6512-268	6512-2681	6512-2682	26×8mm	5µm	5µm
6512-318	6512-3181	6512-3182	31×8mm	5µm	5µm
6512-368	6512-3681	6512-3682	36×8mm	5µm	5µm
6512-1310	6512-13101	6512-13102	13×10mm	5µm	5µm
6512-1810	6512-18101	6512-18102	18×10mm	5µm	5µm
6512-2310	6512-23101	6512-23102	23×10mm	5µm	5µm
6512-2810	6512-28101	6512-28102	28×10mm	5µm	5µm
6512-3310	6512-33101	6512-33102	33×10mm	5µm	5µm
6512-3810	6512-38101	6512-38102	38×10mm	5µm	5µm
6512-1512	6512-15121	6512-15122	15×12mm	5µm	5µm
6512-2012	6512-20121	6512-20122	20×12mm	5µm	5µm
6512-2512	6512-25121	6512-25122	25×12mm	5µm	5µm
6512-3012	6512-30121	6512-30122	30×12mm	5µm	5µm
6512-3512	6512-35121	6512-35122	35×12mm	5µm	5µm
6512-4012	6512-40121	6512-40122	40×12mm	5µm	5µm
6512-1714	6512-17141	6512-17142	17×14mm	5µm	5µm
6512-2214	6512-22141	6512-22142	22×14mm	5µm	5µm
6512-2714	6512-27141	6512-27142	27×14mm	5µm	5µm
6512-3214	6512-32141	6512-32142	32×14mm	5µm	5µm
6512-3714	6512-37141	6512-37142	37×14mm	5µm	5µm
6512-4214	6512-42141	6512-42142	42×14mm	5µm	5µm

L=100mm

Code	H×W	Parallelism between top and bottom	Height difference of a matched pair
6512-52	5×2mm	7µm	7µm
6512-102	10×2mm	5µm	5µm
6512-152	15×2mm	5µm	5µm
6512-202	20×2mm	5µm	5µm
6512-63	6×3mm	7µm	7µm
6512-113	11×3mm	5µm	5µm
6512-163	16×3mm	5µm	5µm
6512-213	21×3mm	5µm	5µm
6512-74	7×4mm	7µm	7µm
6512-124	12×4mm	5µm	5µm
6512-174	17×4mm	5µm	5µm
6512-224	22×4mm	5µm	5µm
6512-85	8×5mm	7µm	7µm
6512-135	13×5mm	5µm	5µm
6512-185	18×5mm	5µm	5µm
6512-235	23×5mm	5µm	5µm
6512-96	9×6mm	7µm	7µm
6512-146	14×6mm	5µm	5µm
6512-196	19×6mm	5µm	5µm
6512-246	24×6mm	5µm	5µm

L=150mm

Code	H×W	Parallelism between top and bottom	Height difference of a matched pair
6512-1410A	14×10mm	5µm	5µm
6512-1610A	16×10mm	5µm	5µm
6512-1810A	18×10mm	5µm	5µm
6512-2010A	20×10mm	5µm	5µm
6512-2210A	22×10mm	5µm	5µm
6512-2410A	24×10mm	5µm	5µm
6512-2610A	26×10mm	5µm	5µm
6512-2810A	28×10mm	5µm	5µm
6512-3010A	30×10mm	5µm	5µm
6512-3210A	32×10mm	5µm	5µm
6512-3510A	35×10mm	5µm	5µm
6512-4010A	40×10mm	5µm	5µm
6512-4510A	45×10mm	5µm	5µm
6512-5010A	50×10mm	5µm	5µm

To be continued

Continued from previous page

L=160mm

Code	H×W	Parallelism between top and bottom	Height difference of a matched pair
6512-104A	10×4mm	5µm	5µm
6512-144A	14×4mm	5µm	5µm
6512-184A	18×4mm	5µm	5µm
6512-224A	22×4mm	5µm	5µm
6512-264A	26×4mm	5µm	5µm
6512-304A	30×4mm	5µm	5µm
6512-344A	34×4mm	5µm	5µm
6512-384A	38×4mm	5µm	5µm
6512-424A	42×4mm	5µm	5µm
6512-128A	12×8mm	5µm	5µm
6512-178A	17×8mm	5µm	5µm
6512-228A	22×8mm	5µm	5µm
6512-258A	25×8mm	5µm	5µm
6512-288A	28×8mm	5µm	5µm
6512-328A	32×8mm	5µm	5µm
6512-368A	36×8mm	5µm	5µm
6512-388A	38×8mm	5µm	5µm

L=200mm

Code	H×W	Parallelism between top and bottom	Height difference of a matched pair
6512-178B	17×8mm	5µm	5µm
6512-228B	22×8mm	5µm	5µm
6512-268B	26×8mm	5µm	5µm
6512-288B	28×8mm	5µm	5µm
6512-328B	32×8mm	5µm	5µm
6512-368B	36×8mm	5µm	5µm
6512-388B	38×8mm	5µm	5µm
6512-428B	42×8mm	5µm	5µm

PARALLEL SETS

- Parallelism between top and bottom: 5µm
- Height difference of a matched pair: 5µm
- Made of alloy tool steel
- Hardened to HRC55-60



6533-144

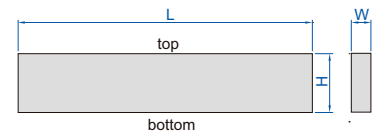

Code	Parallels per set	Length (L)	Thickness (W)	Height (H)
6533-6	6 pairs	200mm	9.5mm	35, 40, 45, 50, 55, 58mm
6533-8	8 pairs	160mm	8mm	12, 17, 22, 25, 28, 32, 36, 38mm
6533-81	8 pairs	200mm	8mm	17, 22, 26, 28, 32, 36, 38, 42mm
6533-9	9 pairs	160mm	4mm	10, 14, 18, 22, 26, 30, 34, 38, 42mm
6533-10	10 pairs	150mm	3mm	13, 16, 19, 22, 25, 28, 31, 35, 38, 41mm
6533-144	14 pairs	150mm	10mm	14, 16, 18, 20, 22, 24, 26, 28, 30, 32, 35, 40, 45, 50mm

PARALLEL SET

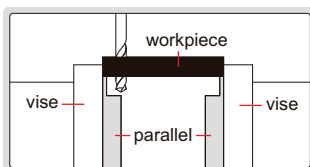

- Parallelism between top and bottom: 5µm
- Height difference of a matched pair: 5µm
- Made of alloy tool steel
- Hardened to HRC55-60



6534-6

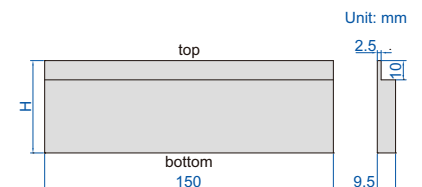

Code	Parallels per set	Height (H)
6534-6	6 pairs	25, 30, 35, 40, 45, 48mm

PARALLEL SETS



6511-20

- Parallelism between top and bottom: 5µm
- Height difference of a matched pair: 5µm
- Made of alloy tool steel
- Hardened to HRC55-60

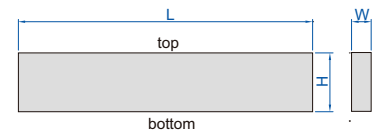

Code	Parallels per set	Length (L)	Height (H)×Thickness (W)
6511-20	20 pairs	100mm	5×2*, 10×2, 15×2, 20×2, 6×3*, 11×3, 16×3, 21×3, 7×4*, 12×4, 17×4, 22×4, 8×5*, 13×5, 18×5, 23×5, 9×6*, 14×6, 19×6, 24×6mm
6511-24	24 pairs	125mm	11×8, 16×8, 21×8, 26×8, 31×8, 36×8, 13×10, 18×10, 23×10, 28×10, 33×10, 38×10, 15×12, 20×12, 25×12, 30×12, 35×12, 40×12, 17×14, 22×14, 27×14, 32×14, 37×14, 42×14mm
6511-241	24 pairs	150mm	11×8, 16×8, 21×8, 26×8, 31×8, 36×8, 13×10, 18×10, 23×10, 28×10, 33×10, 38×10, 15×12, 20×12, 25×12, 30×12, 35×12, 40×12, 17×14, 22×14, 27×14, 32×14, 37×14, 42×14mm

* Parallelism between top and bottom and height difference of a matched pair of 5×2mm, 6×3mm, 7×4mm, 8×5mm and 9×6mm in 6511-20 is 7µm

GRANITE PARALLEL SET



4143-250

- Made of granite, hard and no rusty, no dimensional change over time or temperature change
- Two parallels per set

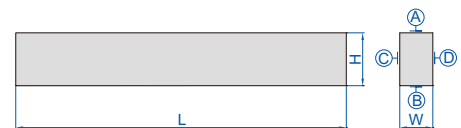
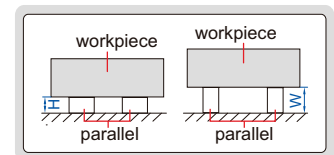

Code	Size (LxWxH)	Parallelism between A and B	Parallelism between C and D	Height difference of a matched pair
4143-250	250x25x40mm	3µm	3µm	3µm

PARALLEL/SQUARE SET

screws and wrench are included



6531-25

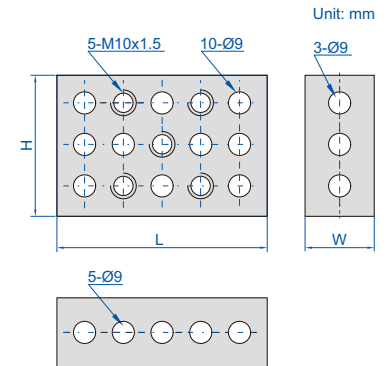

- Pairs of matched blocks for positioning and set-up
- Screws and wrench are included
- Hardness HRC 55-62

Code	Size (L×H×W)	Size accuracy	Squareness	Parallelism	Height difference of a matched pair
6531-25	75×50×25mm	10µm	7µm/25mm	10µm	10µm

ATTENTION:
NOT HARDENED

MAGNETIC INDUCTION PARALLEL SET

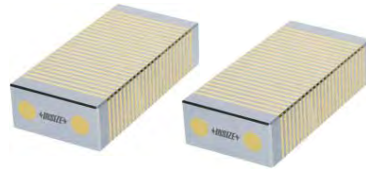

6879-1

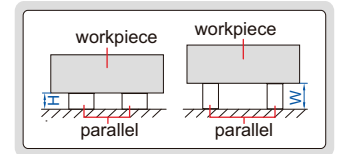

- To be used on magnetic chucks
- Two parallels per set
- Hardness HRB70
- Copper magnetic strips

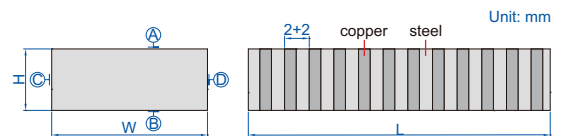

Code	Size (LxWxH)	Pole pitch	Parallelism between A and B	Parallelism between C and D	Height difference of a matched pair
6879-1	100x50x25mm	2+2mm	10µm	10µm	10µm

ANGLE PLATE SETS

- For angle set-up in tooling, production and inspection
- Hardness HRC52



4006-12

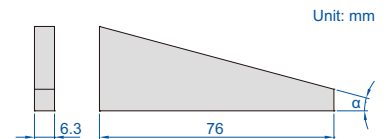

Code	Angle plates included	Angle α	Accuracy
4006-10	10 pcs	1°, 2°, 3°, 4°, 5°, 10°, 15°, 20°, 25°, 30°	±20 seconds
4006-12	12 pcs	1/4°, 1/2°, 1°, 2°, 3°, 4°, 5°, 10°, 15°, 20°, 25°, 30°	±20 seconds

ANGLE PLATE SET

- For angle set-up in tooling, production and inspection
- Made of tool steel
- Hardness HRC55

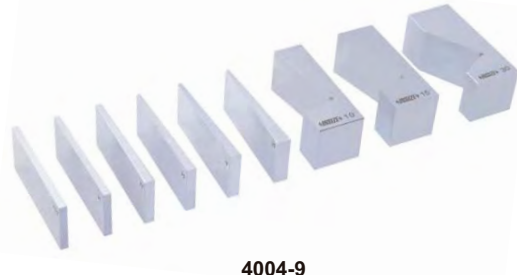

4004-9

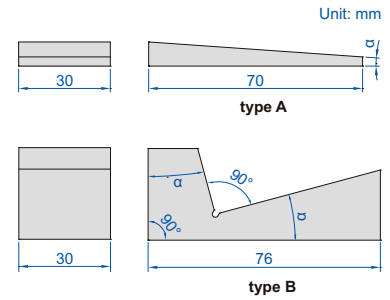

Code	Angle plates included	Angle α	Type	Accuracy
4004-9	9 pcs	1/2°, 1°, 2°, 3°, 4°, 5°	type A	±30 seconds
		10°, 15°, 30°	type B	±50 seconds

ADJUSTABLE ANGLE BLOCKS

- Made of hardened tool steel
- With locking screw
- Accuracy of angle: 10 minutes



6535-30

Code	Size (LxWxH)	h	Adjustable angle	Graduation of angle
6535-25	75x25x36mm	25mm	30°~0°~60°	10 minutes
6535-30	102x30x49mm	30mm	30°~0°~60°	10 minutes

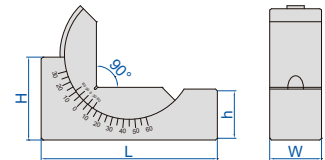

RIGHT ANGLE PLATE

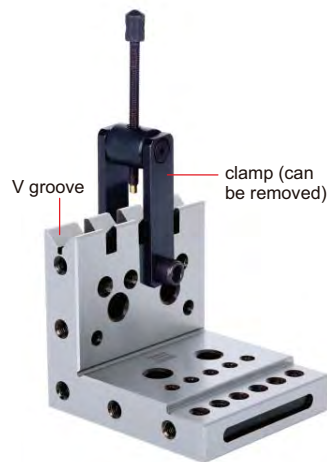

6547-1

- Made of alloy steel
- Hardened to HRC60±2
- V groove for cylinders
- Parallelism and squareness between A, B, C, D, E, F, G and H: 10µm
- Parallelism and squareness of V groove to A, B, C, D, E, F, G and H: 10µm

Code	Size (LxWxH)
6547-1	100x100x115mm

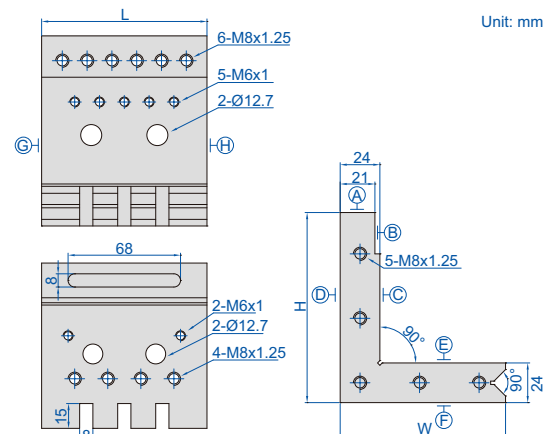

RIGHT ANGLE PLATE

- Made of tool steel
- Hardened to HRC60±2
- Squareness or parallelism between A, B, C and D: 5µm



6548-1

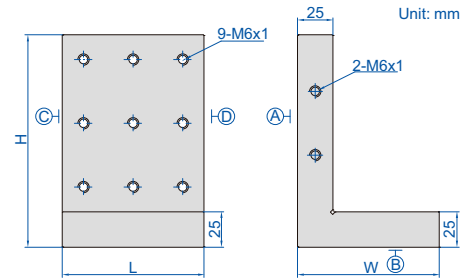

Code	Size (LxWxH)
6548-1	100x100x150mm

RIGHT ANGLE PLATE

- Made of tool steel
- Hardened to HRC56-58
- Parallelism between A, B, C, D, E and F: 3µm
- Squareness between A, B, C, D, E and F: 5µm



6549-1

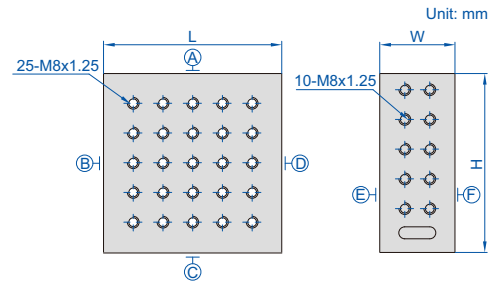

Code	Size (LxWxH)
6549-1	150x63x150mm

CAN BE CUSTOMIZED

SINE BARS



4155-100

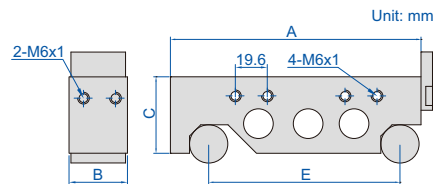

- Made of alloy tool steel

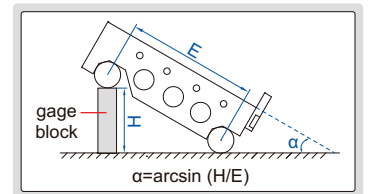

the front and back ends and two sides have mounting holes to install plate

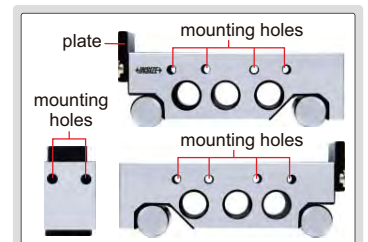

Code	Roller distance (E)	Table size (AxB)	C	Accuracy of α at 30°
4155-100	100mm	130x30mm	40mm	±5 seconds
4155-200	200mm	230x30mm	40mm	±5 seconds
4155-300	300mm	345x40mm	50mm	±8 seconds

SINE BAR



4158-100

- Made of alloy tool steel

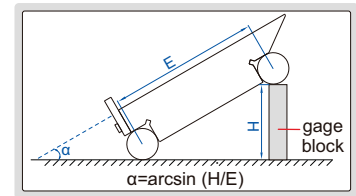
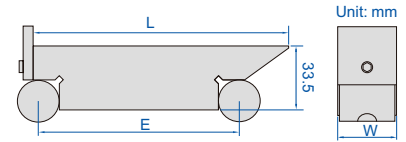

Code	Roller distance (E)	Table size (LxW)	Accuracy of α at 30°
4158-100	100mm	130x30mm	± 5 seconds

COMPOUND SINE TABLE



6536-100

- Accuracy of angle: ± 15 seconds
- Made of alloy tool steel
- Hardness HRC58-60

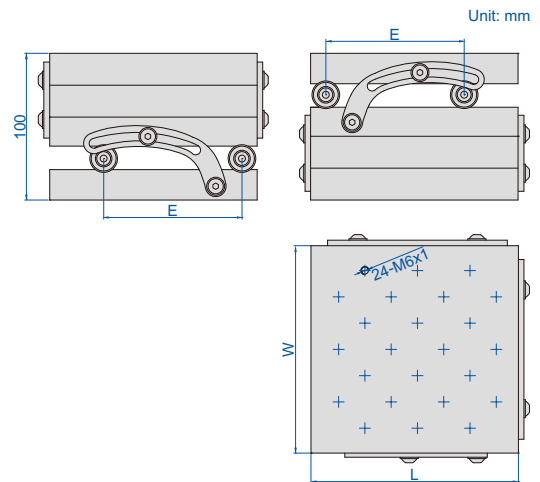

Code	Roller distance (E)	Table size (LxW)	Adjustable angle
6536-100	100mm	150x150mm	0-60°

SINE TABLE



6527-100

- Accuracy of angle: ± 15 seconds
- Made of alloy tool steel
- Hardness HRC58-60

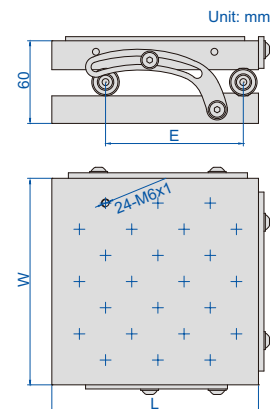

Code	Roller distance (E)	Table size (LxW)	Adjustable angle
6527-100	100mm	150x150mm	0-60°

**ATTENTION:
NOT HARDENED**

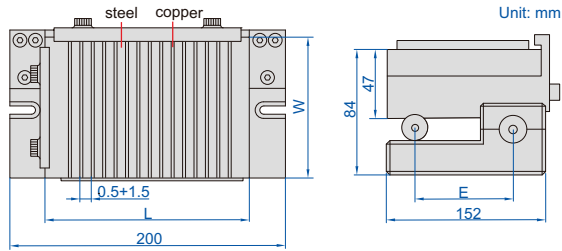

MAGNETIC SINE TABLE



6538-100

Code	Table size (L×W)	Roller distance (E)	Adjustable angle	Accuracy of angle
6538-100	150×150mm	100mm	0-60°	±15 seconds

PRECISION SINE VISE

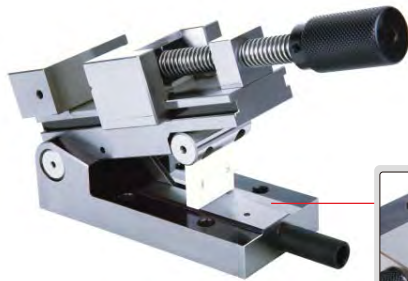

6522-80

there is a 1mm step (accuracy +/-0.002mm). gage blocks smaller than 0.5mm are not available. if small gage blocks are needed (for example, 0.25mm), a gage block 1.25mm can be used in order to make 1.25mm-1mm=0.25mm



- Parallelism: 3µm/100mm
- Squareness: 5µm/100mm
- Accuracy of angle: ±15 seconds
- Made of SKS tool steel, subzero treatment
- Hardness HRC58-60

Code	Jaw opening (Q)	Jaw width (W)	Adjustable angle
6522-80	0-80mm	73mm	0-46°

PRECISION SINE VISE

there is a 1mm step (accuracy +/-0.002mm). gage blocks smaller than 0.5mm are not available. if small gage blocks are needed (for example, 0.25mm), a gage block 1.25mm can be used in order to make 1.25mm-1mm=0.25mm



6523-80

- Parallelism: 3µm/100mm
- Squareness: 5µm/100mm
- Accuracy of angle: ±15 seconds
- Made of SKS tool steel, subzero treatment
- Hardness HRC58-60

Code	Jaw opening (Q)	Jaw width (W)	Adjustable angle
6523-80	0-80mm	73mm	0-46°

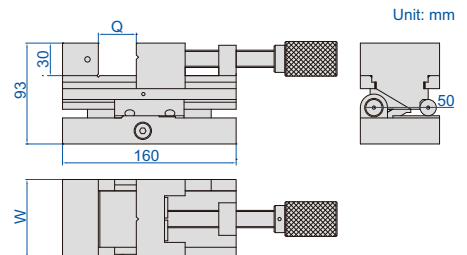

PRECISION COMPOUND SINE VISE

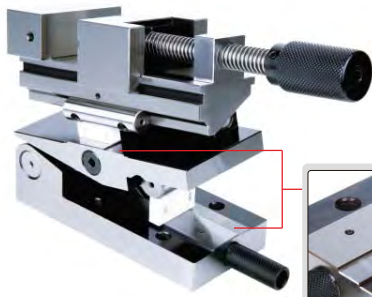

there is a 1mm step (accuracy $\pm 0.002\text{mm}$). gage blocks smaller than 0.5mm are not available. if small gage blocks are needed (for example, 0.25mm), a gage block 1.25mm can be used in order to make $1.25\text{mm} - 1\text{mm} = 0.25\text{mm}$

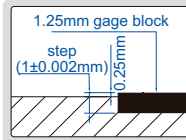

6524-80

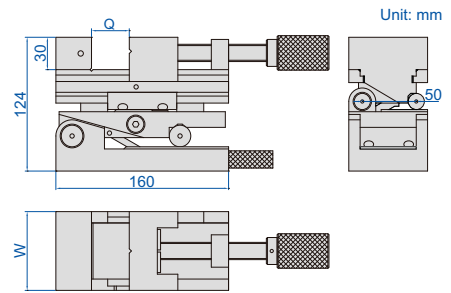

- Parallelism: $3\mu\text{m}/100\text{mm}$
- Squareness: $5\mu\text{m}/100\text{mm}$
- Accuracy of angle: ± 15 seconds
- Made of SKS tool steel, subzero treatment
- Hardness HRC58-60

Code	Jaw opening (Q)	Jaw width (W)	Adjustable angle
6524-80	0-80mm	73mm	0-46°

PRECISION UNIVERSAL VISE

- Horizontal rotary: range 360° , graduation 0.05°
- Vertical incline: range 45° , graduation 0.05°
- With incline adjust knob
- Parallelism and squareness between A, B, C and D: $5\mu\text{m}/100\text{mm}$, parallelism between D and E at 0° : $10\mu\text{m}/100\text{mm}$
- Made of tool steel
- Hardness HRC56-58

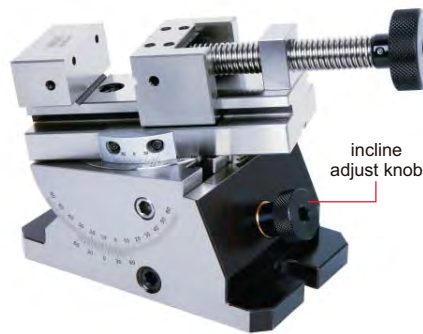

6521-80

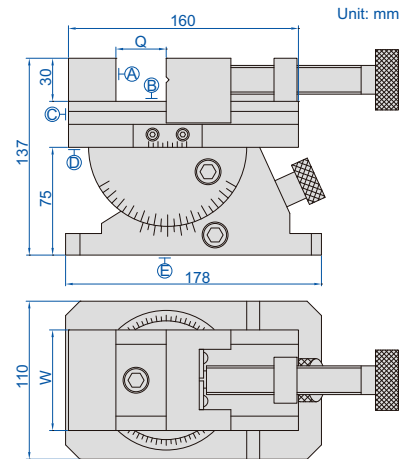

Code	Jaw opening (Q)	Jaw width (W)
6521-80	0-80mm	70mm

PRECISION UNIVERSAL VISE WITH CHUCK

- Horizontal rotary: range 360° , graduation 0.05°
- Vertical incline: range 45° , graduation 0.05°
- With vertical incline adjust knob
- Runout of chuck is less than 0.05mm (test position is at less than 50mm from clamping jaws)
- The clamping jaws of chuck are reversible
- Made of tool steel
- Hardness HRC56-58

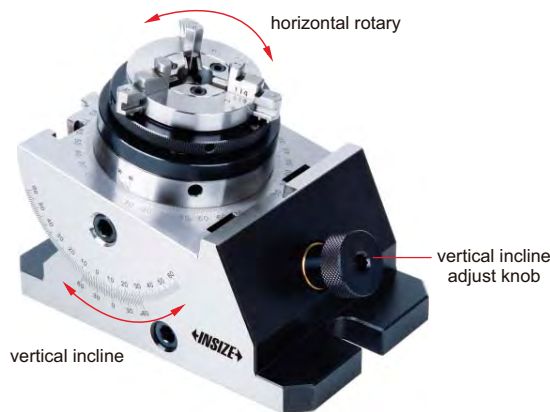

6528-85

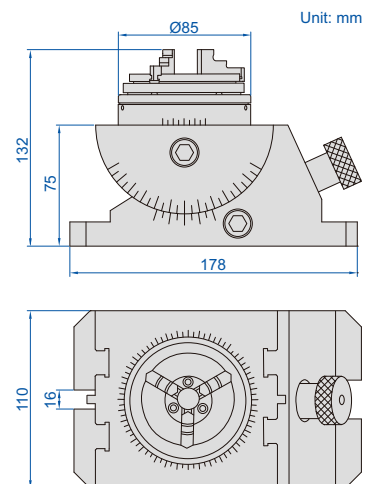

Code	Range of external clamping	Range of internal clamping
6528-85	$\text{Ø}0.8\text{--}\text{Ø}63\text{mm}$	$\text{Ø}23\text{--}\text{Ø}58\text{mm}$

PRECISION VISES

- Parallelism: 8µm/100mm
- Squareness: 10µm/100mm
- Made of alloy steel
- Hardness HRC56-58



6520-73A

Code	Jaw opening (Q)	Jaw width (W)	L	H	M
6520-63A	0-63mm	48mm	156mm	52mm	25mm
6520-73A	0-73mm	63mm	176mm	63mm	30mm
6520-76A	0-76mm	73mm	190mm	73mm	35mm
6520-115A	0-115mm	88mm	250mm	80mm	42mm
6520-120A	0-120mm	98mm	255mm	82mm	40mm
6520-152A	0-152mm	125mm	310mm	100mm	50mm
6520-165A	0-165mm	150mm	325mm	100mm	50mm

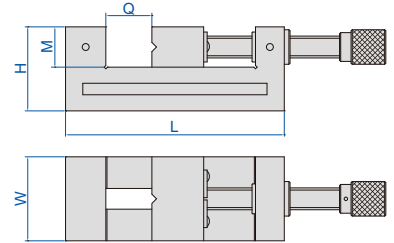

PRECISION VISES

- Parallelism: 3µm/100mm
- Squareness: 5µm/100mm
- Made of alloy steel
- Hardness HRC56-58



6526-80

Code	Jaw opening (Q)	Jaw width (W)	Overall length (L)	H	M
6526-80	0-80mm	50mm	150mm	53mm	25mm
6526-100	0-100mm	73mm	190mm	70mm	35mm

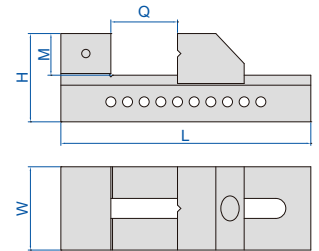

17

ANVIL VISES

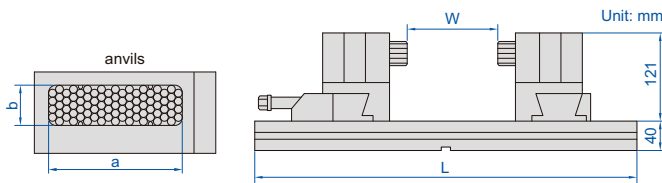

- The vise is used to fix workpieces during machining. The anvils are formed according to the shape of workpieces to be fixed, so the vise can fix workpieces quickly.
- The anvils are made of stainless steel (HRC20), can be customized to carbon steel (HRC40-45)
- Diameter of anvil: 6mm, stroke of anvil: 24mm
- Movement range of rotary clamp: 0-50mm

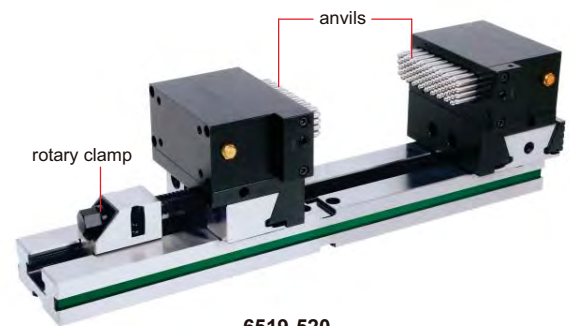

6519-520

application



Code	Guide length (L)	Clamp range (W)	Clamp force*	Weight	a	b
6519-520	520mm	0-190mm	6500N	22.5kg	100mm	30mm
6519-680	680mm	0-320mm	8000N	39.5kg	120mm	36mm

* When all anvils contact the workpieces

X-AXIS STAGES



6582-401

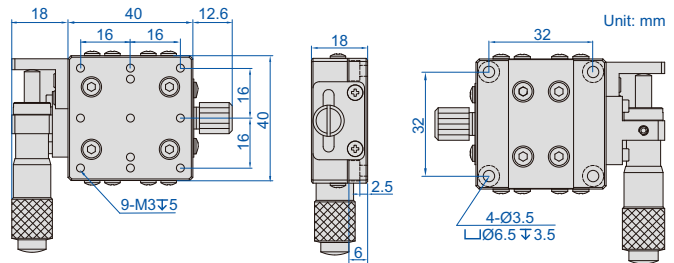

6582-602

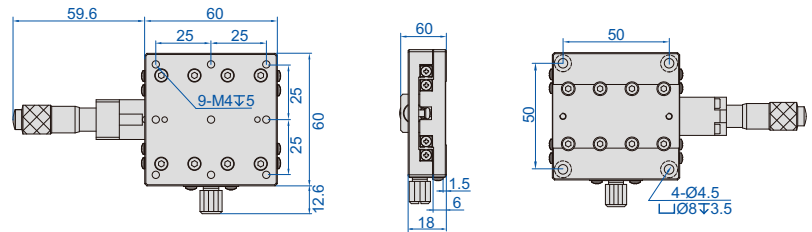

6582-903

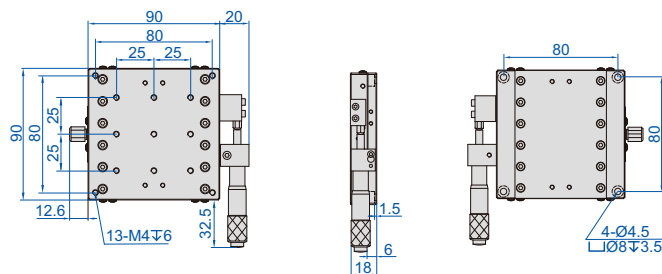

- Cross roller guides, achieve high precision and smooth movement
- Stages made of aluminum alloy

SPECIFICATION (micrometer on the left)

Code	X-axis displacement	Parallelism of top to bottom surface	Micrometer graduation	Micrometer accuracy	Maximum load	Micrometer location	Stage size	Weight
6582-401	±6.5mm	0.02mm	0.01mm	0.01mm	29.4N (3kgf)	left	40x40mm	0.14kg
6582-601	±6.5mm	0.03mm	0.01mm	0.01mm	49N (5kgf)	left	60x60mm	0.24kg
6582-901	±12.5mm	0.03mm	0.01mm	0.02mm	93.1N (9.5kgf)	left	90x90mm	0.47kg
6582-1251	±12.5mm	0.04mm	0.01mm	0.02mm	180N (18.4kgf)	left	125x125mm	1.40kg

SPECIFICATION (micrometer in the middle)

Code	X-axis displacement	Parallelism of top to bottom surface	Micrometer graduation	Micrometer accuracy	Maximum load	Micrometer location	Stage size	Weight
6582-402	±6.5mm	0.02mm	0.01mm	0.01mm	29.4N (3kgf)	middle	40x40mm	0.14kg
6582-602	±6.5mm	0.03mm	0.01mm	0.01mm	49N (5kgf)	middle	60x60mm	0.24kg
6582-902	±12.5mm	0.03mm	0.01mm	0.02mm	93.1N (9.5kgf)	middle	90x90mm	0.47kg
6582-1252	±12.5mm	0.04mm	0.01mm	0.02mm	180N (18.4kgf)	middle	125x125mm	1.40kg

SPECIFICATION (micrometer on the right)

Code	X-axis displacement	Parallelism of top to bottom surface	Micrometer graduation	Micrometer accuracy	Maximum load	Micrometer location	Stage size	Weight
6582-403	±6.5mm	0.02mm	0.01mm	0.01mm	29.4N (3kgf)	right	40x40mm	0.14kg
6582-603	±6.5mm	0.03mm	0.01mm	0.01mm	49N (5kgf)	right	60x60mm	0.24kg
6582-903	±12.5mm	0.03mm	0.01mm	0.02mm	93.1N (9.5kgf)	right	90x90mm	0.47kg
6582-1253	±12.5mm	0.04mm	0.01mm	0.02mm	180N (18.4kgf)	right	125x125mm	1.40kg

XY-AXIS STAGES

Unit: mm

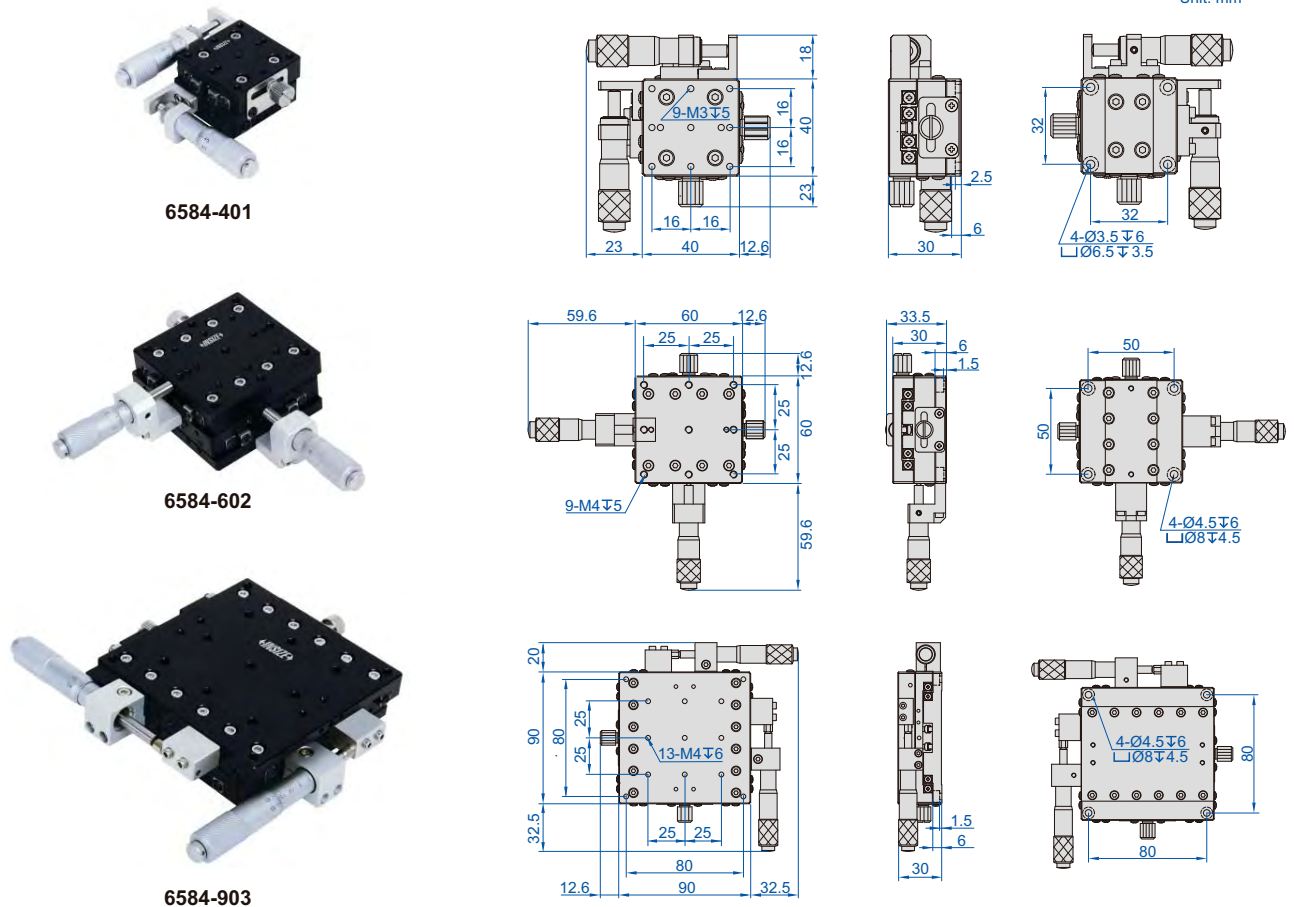

- Cross roller guides, achieve high precision and smooth movement
- Stages made of aluminum alloy

SPECIFICATION (micrometer on the left)

Code	XY-axis displacement	Parallelism of top to bottom surface	Micrometer graduation	Micrometer accuracy	Maximum load	Micrometer location	Stage size	Weight
6584-401	±6.5mm	0.04mm	0.01mm	0.01mm	29.4N (3kgf)	left	40x40mm	0.27kg
6584-601	±6.5mm	0.06mm	0.01mm	0.01mm	49N (5kgf)	left	60x60mm	0.48kg
6584-901	±12.5mm	0.06mm	0.01mm	0.02mm	93.1N (9.5kgf)	left	90x90mm	1kg
6584-1251	±12.5mm	0.08mm	0.01mm	0.02mm	180N (18.4kgf)	left	125x125mm	2.8kg

SPECIFICATION (micrometer in the middle)

Code	XY-axis displacement	Parallelism of top to bottom surface	Micrometer graduation	Micrometer accuracy	Maximum load	Micrometer location	Stage size	Weight
6584-402	±6.5mm	0.04mm	0.01mm	0.01mm	29.4N (3kgf)	middle	40x40mm	0.27kg
6584-602	±6.5mm	0.06mm	0.01mm	0.01mm	49N (5kgf)	middle	60x60mm	0.48kg
6584-902	±12.5mm	0.06mm	0.01mm	0.02mm	93.1N (9.5kgf)	middle	90x90mm	1kg
6584-1252	±12.5mm	0.08mm	0.01mm	0.02mm	180N (18.4kgf)	middle	125x125mm	2.8kg

SPECIFICATION (micrometer on the right)

Code	XY-axis displacement	Parallelism of top to bottom surface	Micrometer graduation	Micrometer accuracy	Maximum load	Micrometer location	Stage size	Weight
6584-403	±6.5mm	0.04mm	0.01mm	0.01mm	29.4N (3kgf)	right	40x40mm	0.27kg
6584-603	±6.5mm	0.06mm	0.01mm	0.01mm	49N (5kgf)	right	60x60mm	0.48kg
6584-903	±12.5mm	0.06mm	0.01mm	0.02mm	93.1N (9.5kgf)	right	90x90mm	1kg
6584-1253	±12.5mm	0.08mm	0.01mm	0.02mm	180N (18.4kgf)	right	125x125mm	2.8kg

Z-AXIS STAGE CODE 6586-60

Unit: mm

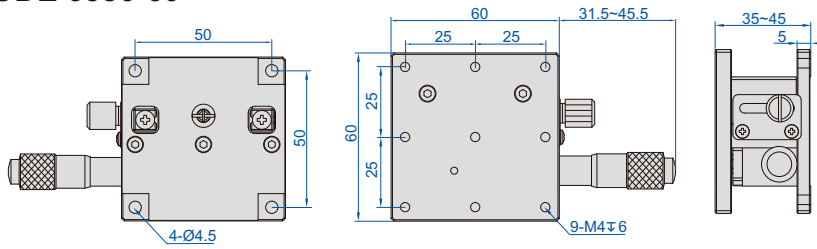

- Cross roller guides, achieve high precision and smooth movement
- Stage made of aluminum alloy

SPECIFICATION

Code	Z-axis displacement	Parallelism of top to bottom surface	Micrometer graduation	Micrometer accuracy	Maximum load	Stage size	Weight
6586-60	10mm	0.05mm	0.01mm	0.02mm	20.4N (3kgf)	60x60mm	0.27kg

XZ-AXIS STAGE CODE 6587-60

Unit: mm

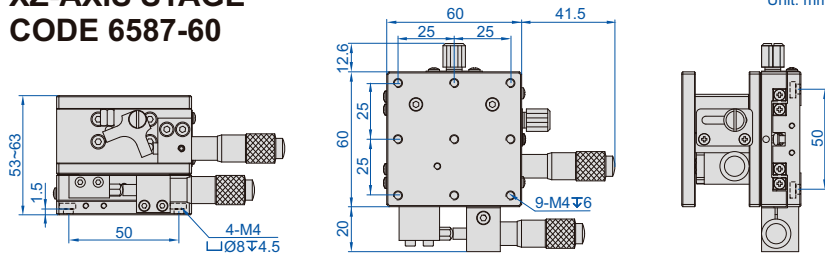

- Cross roller guides, achieve high precision and smooth movement
- Stage made of aluminum alloy

SPECIFICATION

Code	X-axis displacement	Z-axis displacement	Micrometer graduation	Maximum load	Stage size	Weight
6587-60	±6.5mm	10mm	0.01mm	29.4N (3kgf)	60x60mm	0.51kg

XYZ-AXIS STAGE CODE 6585-60

Unit: mm

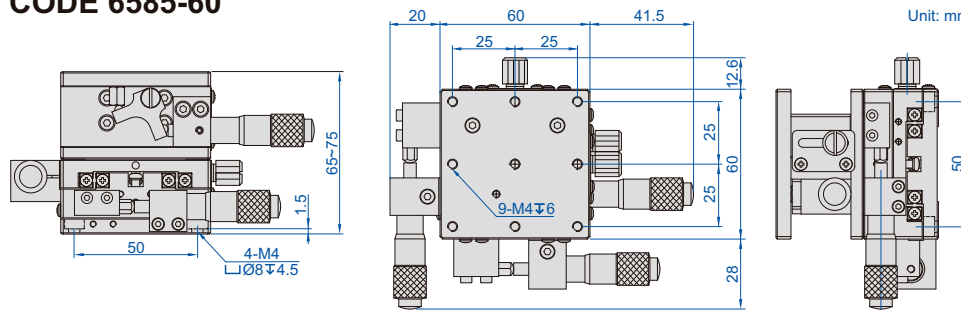

- Cross roller guides, achieve high precision and smooth movement
- Stage made of aluminum alloy

SPECIFICATION

Code	XY-axis displacement	Z-axis displacement	Micrometer graduation	Maximum load	Stage size	Weight
6585-60	±6.5mm	10mm	0.01mm	29.4N (3kgf)	60x60mm	0.75kg

ROTARY STAGES



6583-60H



6583-90

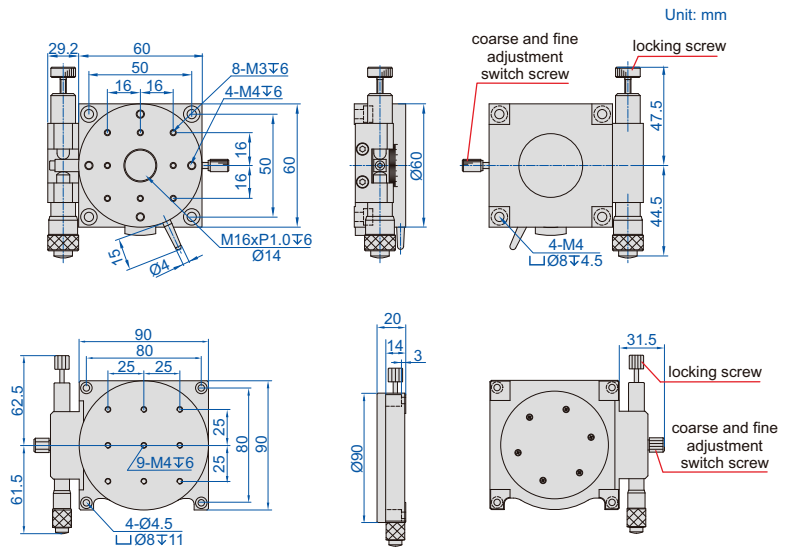

- Precise angle adjustment
- Coarse and fine adjustments
- Stages made of aluminum alloy

SPECIFICATION

Code	Range	Parallelism of top to bottom surface	Concentricity	Rotation accuracy	Maximum load	Stage size	Weight
6583-60H	360° coarse, ±5° fine	0.03mm	0.03mm	12'	29.4N (3kgf)	Ø60mm	0.30kg
6583-90	360° coarse, ±5° fine	0.04mm	0.03mm	5'	29.4N (3kgf)	Ø90mm	0.50kg

XY-AXIS ROTARY STAGE CODE 6588-60

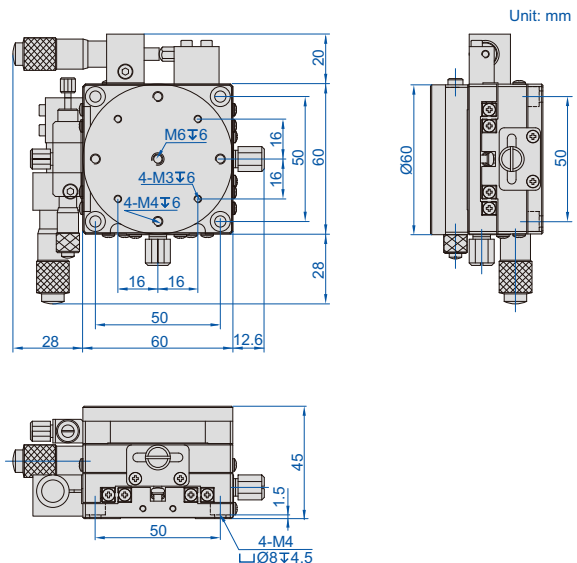

- Cross roller guides, achieve high precision and smooth movement
- Coarse and fine adjustments
- Precise angle adjustment
- Stage made of aluminum alloy

SPECIFICATION

Code	XY-axis displacement	Rotation range	Micrometer graduation	Rotation accuracy	Maximum load	Stage size	Weight
6588-60	±6.5mm	360° coarse, ±5° fine	0.01mm	10'	29.4N (3kgf)	60x60mm	0.64kg



Infrared Transmission Probes For CNC Machine Tools
Page 427-428



Video Measuring Instrument For Machine Tools
Page 429-430



Trigger-Type 3D Probes
Page 431



Centering Indicators
Page 432



Edge Finders
Page 432-434



Edge Finders For EDM
Page 435



Zero Setters With Cable
Page 436



Zero Setters
Page 437



Zero Setters
Page 438-439



INFRARED TRANSMISSION PROBES FOR CNC MACHINE TOOLS

IP68
WATERPROOF

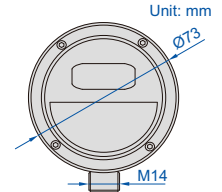
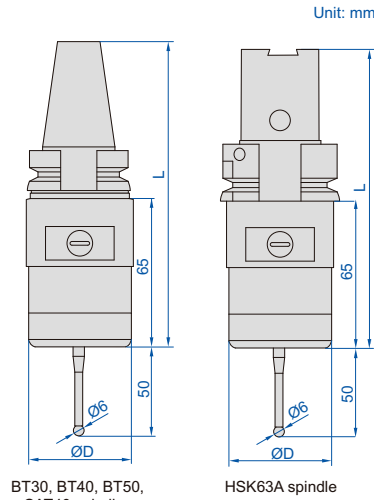

- On-machine measurement of all kinds of small and medium-sized machining centers, CNC boring, milling machines and five-axis CNC machine tools
- Automatically set the workpiece coordinate and machining reference point before CNC machining process
- Automatically measure dimension and position coordinate during CNC machining
- Measure dimension, shape and position after CNC machining is completed
- Four kinds of SSR signals such as probe status, error, low voltage and pulse are transmitted to CNC machine tools
- M code is used to control on or off of probes
- Infrared transmission, strong anti-interference
- Infrared transmission/reception range: 5m
- Supplied with automatic measurement software
- Optional accessory: styli

18

PROBE SPECIFICATION

Code	9413-1	9413-2	9413-3	9413-4	9413-5
Probe length (L)	140mm	166mm	216mm	168mm	136mm
Probe diameter (ØD)	48mm	48mm	48mm	48mm	48mm
Applicable spindle *	BT30	BT40	BT50	CAT40	HSK63A
Trigger accuracy of styli in any direction	1µm				
Protection stroke triggered by styli in all directions	X and Y axis stroke: ±12.5°, Z axis stroke: 5mm				
Trigger force of styli in all directions	X and Y axis: 1-1.6N, Z axis: 5-10N				
Dust/waterproof	IP68				
Power supply	2×LS14250 lithium battery				

* SK and ISO spindle probes also can be customized

RECEIVER SPECIFICATION

Code	9413-A
Protection function	low battery voltage or probe transmitting signal all the time**
Applicable probe	code 9413-1, 9413-2, 9413-3, 9413-4, 9413-5
Cable length	8m
Dust/waterproof	IP68
Power supply	input voltage: 24V±10% (DC), load current: 50mA

** When battery voltage is low or probe is in wrong state, receiver sends a signal to CNC machine to stop working

To be continued

Continued from previous page

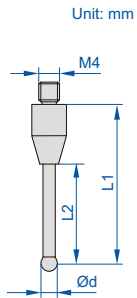

STYLI (OPTIONAL)

(mm)

Code	L1	L2	Ød	Material of rod ***	Material of ball
9410-P1	18	13	4	stainless steel	ruby
9410-P2	18	13.5	5	stainless steel	ruby
9410-P3	18.5	13	3	stainless steel	ruby
9410-P4	19	8	2	carbide	ruby
9410-P5	19.5	4	1	carbide	ruby
9410-P6	50	40	2	carbide	ruby
9410-P7	50	34	5	ceramic	ruby
9410-P8	100	86	6	ceramic	ruby

*** For stainless steel or carbide rods, it is recommended to use extension rods to protect spindles in case of break

application

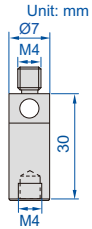
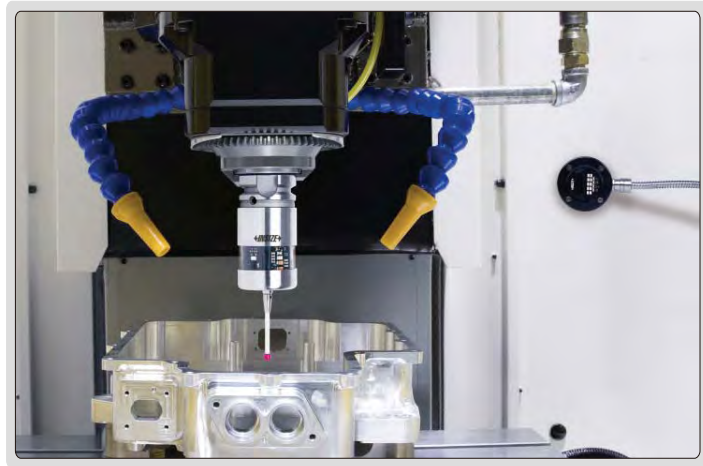

18

EXTENSION ROD (OPTIONAL)

Code	Material
9410-R1	ceramic

AUTOMATIC MEASUREMENT SOFTWARE (INCLUDED)

1. Stylus automatic calibration
2. Protection of stylus during probe movement (avoid collision)
3. Groove and boss measurement

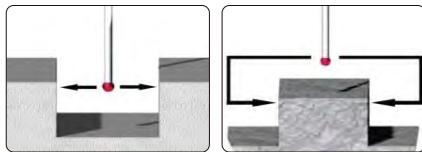

5. X or Y single-surface measurement



7. 4th axis measurement
8. Angle on X and Y plane measurement
9. Three points measurement of arc

4. Bore and axis measurement

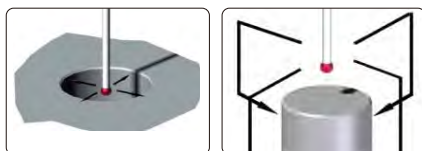

6. Internal and external corner measurement

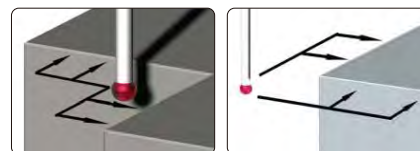

10. Measure the distance between two holes





VIDEO MEASURING INSTRUMENT FOR MACHINE TOOLS

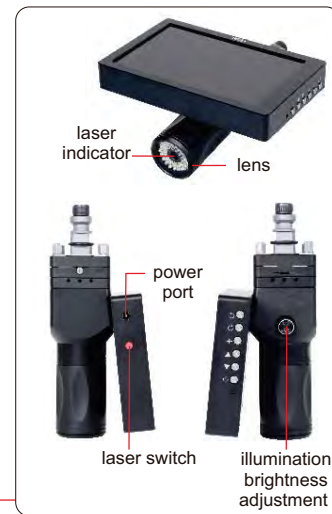

application

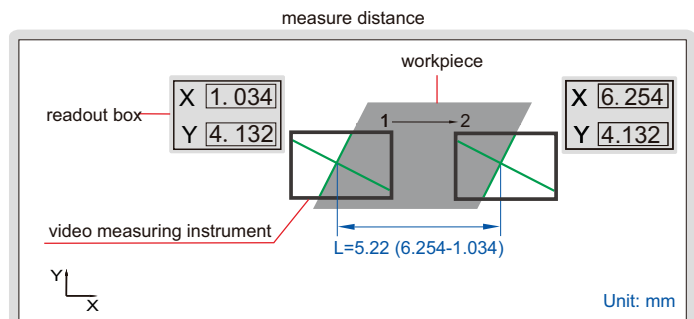
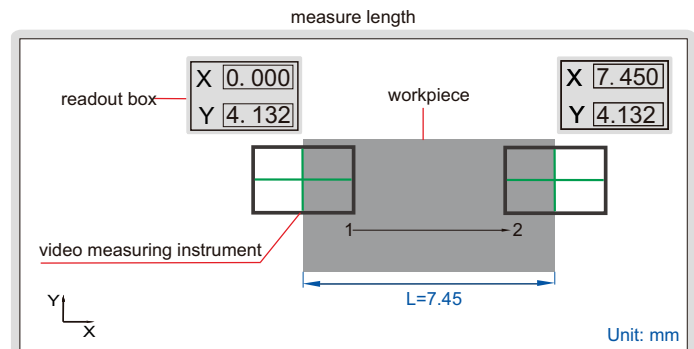
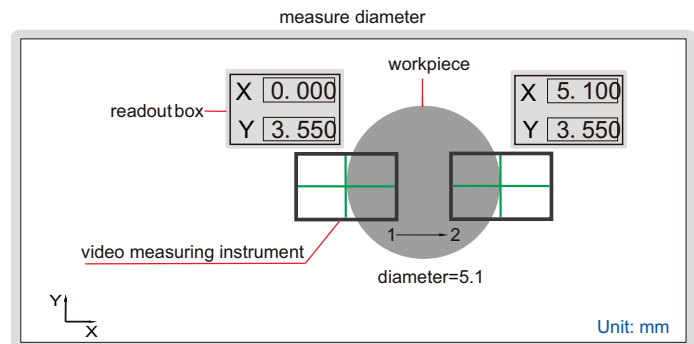
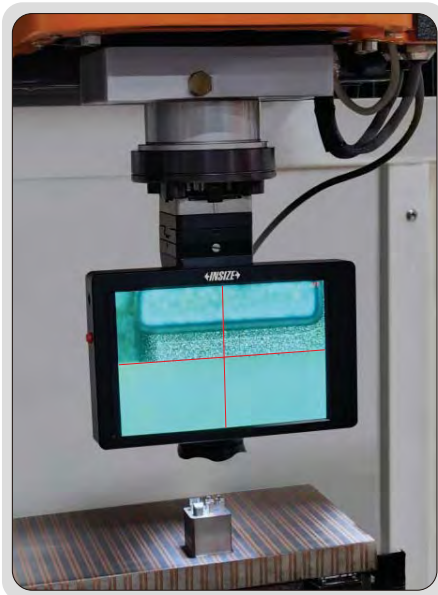

- Used in machine tools such as EDM and CNC
- Working together with linear scale and readout box of machine tools to make 2D measurement, especially suitable for small or thin parts
- Can rotate crosshair and change its color
- With laser indicator to locate position

To be continued

Continued from previous page

SPECIFICATION

Code	5314-R31	5314-R32	5314-R33	5314-R34
Adapter	EROWA	3R	multifunction	magnet
Screen size/pixel	7"/1080P			
Visual accuracy	±0.003mm			
Magnification	50X			
Angle resolution	15'			
Automatic edge-find	after finding the edge, the crosshair changes to green color and prompts			
Color of crosshair	red, blue			
Rotation of crosshair	manual			
Focus distance	50mm			
Light source	LED (adjustable brightness)			
Lithium battery	4800mA (for 4 hours working)			
Power supply	power adapter			
Dimension (LxWxH)	178x90x215mm			
Weight	2kg			

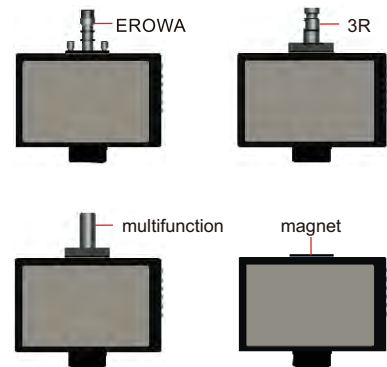

STANDARD DELIVERY

Main unit	1 pc
Power adapter	1 pc

select crosshair color



rotate crosshair

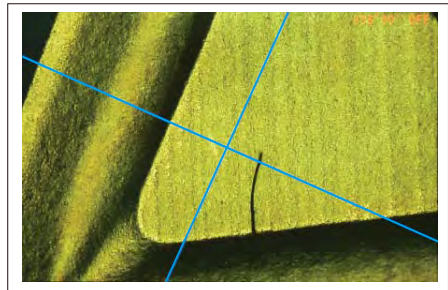

18

laser indicator locates the central point

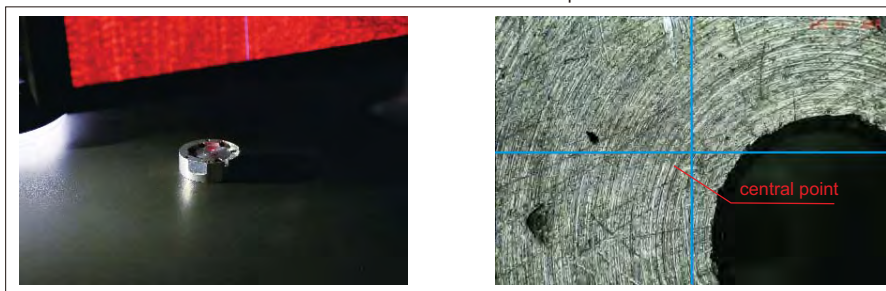

after finding the edge, the crosshair changes to green color and prompts

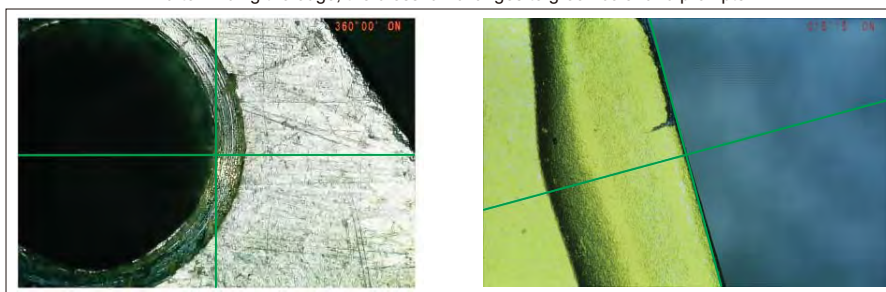

IP67
WATERPROOF

TRIGGER-TYPE 3D PROBE (AUDIBLE AND VISUAL ALARM) CODE 9410

type-C charging cable (included)



signal extension cord (included)

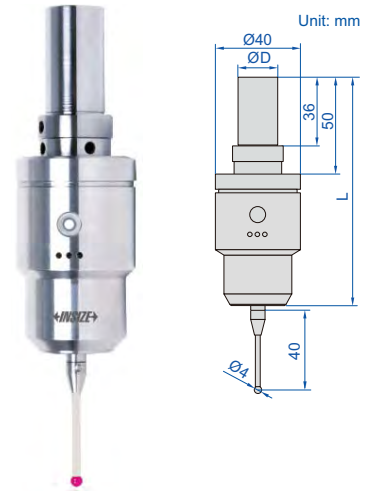

- Suitable for all kinds of machining centers, CNC boring machines, milling machines, drilling and tapping centers
- Suitable for workpiece detection of various solid materials
- Manually set the workpiece coordinates and machining reference points before CNC machining process
- In the process of CNC machining, manually detect and control key dimensions and position coordinates and their accuracy
- Detect the accuracy of the key size, shape and position of the workpiece after completion of CNC machining
- Standard Ø20mm shank diameter, held by CNC
- LED indicator and buzzer indicate the trigger state of the probe
- Using lithium battery charging technology, no need to replace the battery
- The battery (5% utilization rate per shift) can be used continuously for 90 days
- Type-C interface
- Optional accessory: styli and extension bar

SPECIFICATION

Probe length (L)	115.5mm
Shank diameter (ØD)	20mm
Trigger direction	±X, ±Y, +Z
Directional trigger protection stroke	X-Y: ±12°, Z: +5mm
Arbitrary one-way repeated trigger accuracy	≤1µm
Trigger force in X-Y direction (with standard styli)	0.3-0.6N
Trigger force in Z direction	4N
Class of protection	IP67
Type-C charging cable	1.5m
Signal extension cord (provide signals to CNC)	1m

application

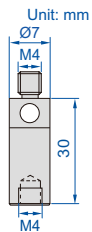
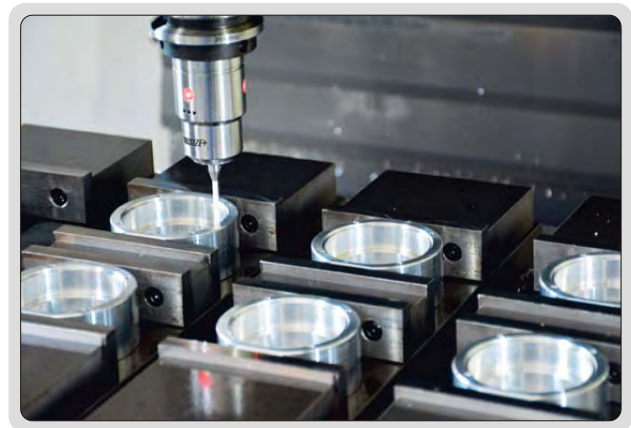

EXTENSION BAR (OPTIONAL)

Code	Material
9410-R1	ceramic

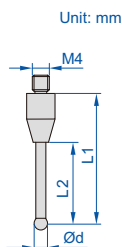

STYLI (OPTIONAL)

(mm)

Code	L1	L2	Ød	Material of rod	Material of ball
9410-P1	18	13	4	stainless steel	ruby
9410-P2	18	13.5	5	stainless steel	ruby
9410-P3	18.5	13	3	stainless steel	ruby
9410-P4	19	8	2	carbide	ruby
9410-P5	19.5	4	1	carbide	ruby
9410-P6	50	40	2	carbide	ruby
9410-P7	50	34	5	ceramic	ruby
9410-P8	100	86	6	ceramic	ruby

CENTERING INDICATOR



POPULAR MODEL



2385-3

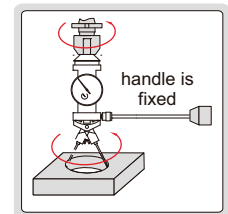
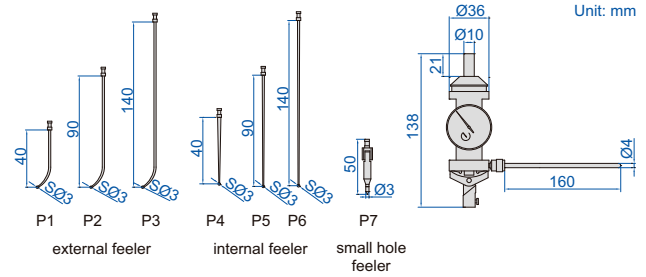

- Provides quick and accurate centering in boring and milling set-up
- Maximum speed is recommended not to exceed 800rpm

Feeler	Measuring diameter	Accuracy
P1	Ø0-60mm	0.015mm
P2	Ø0-160mm	0.02mm
P3	Ø0-250mm	0.03mm
P4	Ø3.2-80mm	0.015mm
P5	Ø3.2-180mm	0.02mm
P6	Ø3.2-280mm	0.03mm
P7	Ø0-2.8mm	0.015mm

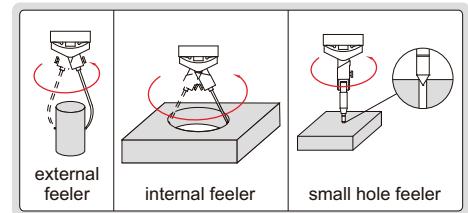

Code
2385-3

18

3D ELECTRONIC EDGE FINDERS

INSIZE PLUS
MADE IN EUROPE

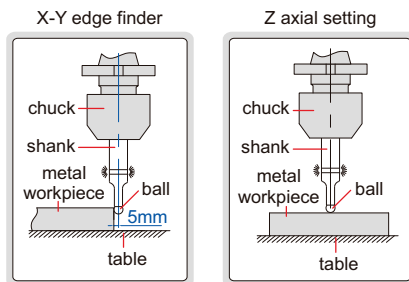

6571-1

6571-2

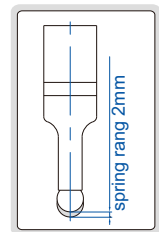

- The shank is electrically conducted to the metal workpiece through the chuck and table. The LED lights up, when the ball touches the workpiece
- Not suitable for rotary use
- Hardened contact ball

Code	Shank	Contact ball	Accuracy	Battery
6571-1	Ø16mm	SØ10mm	10µm	23A, 12Vx1 pc
6571-2	Ø20mm	SØ10mm	10µm	23A, 12Vx1 pc

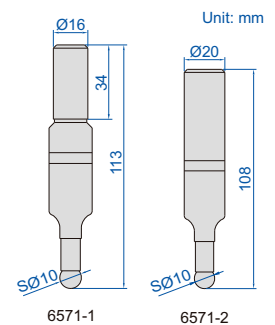

LARGE SHANK ELECTRONIC EDGE FINDERS

- The shank is electrically conducted to the metal workpiece through the chuck and table. The LED lights up and the beeper sounds (only for **6572-2**), when the ball touches the workpiece
- Not suitable for rotary use
- Hardened shank and contact ball

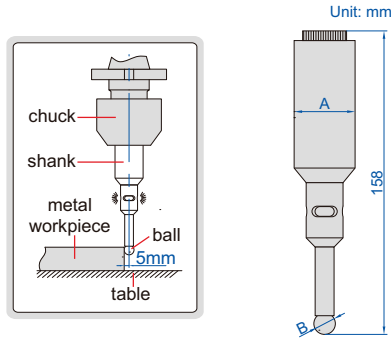

Code	Shank (A)	Contact ball (B)	Accuracy	Beeper	Battery
6572-1	Ø32mm	SØ10mm	5µm	without	23A, 12V×1 pc
6572-2	Ø32mm	SØ10mm	5µm	with	23A, 12V×1 pc

ELECTRONIC EDGE FINDERS

- The shank is electrically conducted to the metal workpiece through the chuck and table. The LED lights up and the beeper sounds (only for **6566-3**), when the ball touches the workpiece
- Not suitable for rotary use
- Hardened shank and contact ball

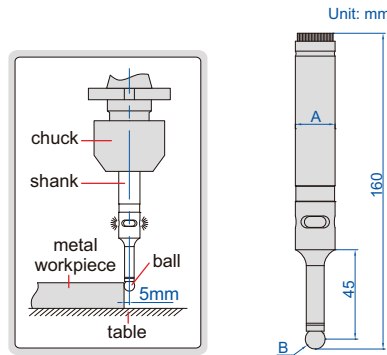

Code	Shank (A)	Contact ball (B)	Accuracy	Beeper	Battery
6566-2	Ø20mm	SØ10mm	5µm	without	23A, 12V×1 pc
6566-3	Ø20mm	SØ10mm	5µm	with	23A, 12V×1 pc

NON-MAGNETIC EDGE FINDERS

- TiAlN coating, non-magnetic, hardness HV2500, extremely wear resistance
- Suitable for machine speed 400~600rpm

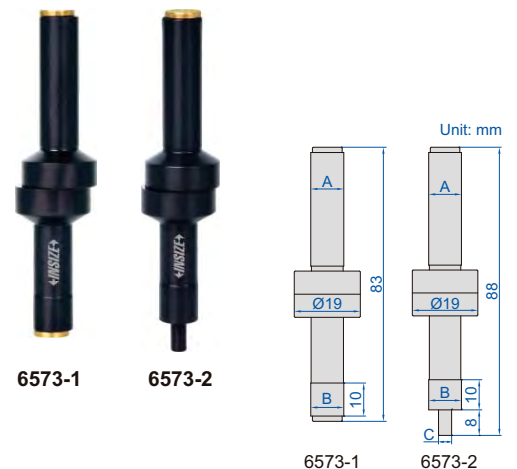
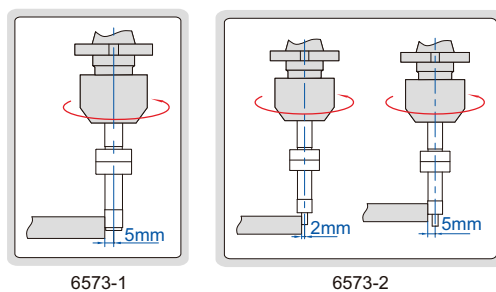

Code	Shank (A)	Contact point (B)	Contact point (C)	Accuracy
6573-1	Ø10mm	Ø10mm	—	5µm
6573-2	Ø10mm	Ø10mm	Ø4mm	5µm

EDGE FINDERS

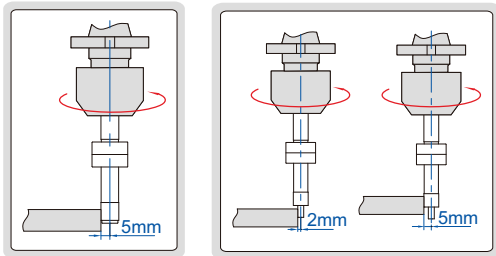

6562-3

6562-4

- Hardened shank and contact point
- Suitable for machine speed 400~600rpm

Code	Shank (A)	Contact point (B)	Contact point (C)	Accuracy
6562-3	Ø10mm	Ø10mm	—	5µm
6562-4	Ø10mm	Ø10mm	Ø4mm	5µm



6562-3

6562-4

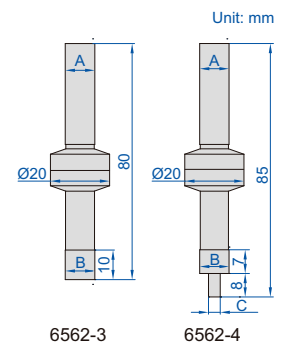

6562-3

6562-4

EDGE FINDER

18

- Hardened shank and contact point
- Suitable for machine speed 400~600rpm

Code	Shank (A)	Contact point (B)	Accuracy
6567-1	Ø10mm	Ø6mm	8µm

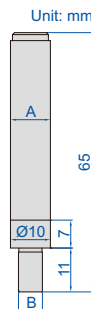

6567-1

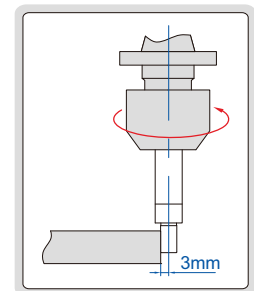

CERAMIC EDGE FINDER

- Ceramic contact point, non magnetic
- Suitable for machine speed 400~600rpm

Code	Shank (A)	Contact point (B)	Accuracy
6568-1	Ø10mm	Ø10mm	8µm

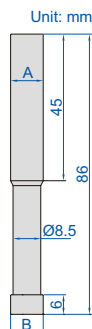

6568-1

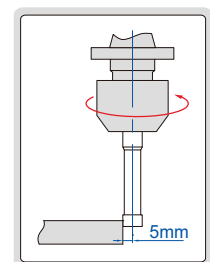

EDGE FINDERS FOR EDM

CAN BE
CUSTOM-MADE

spindle type

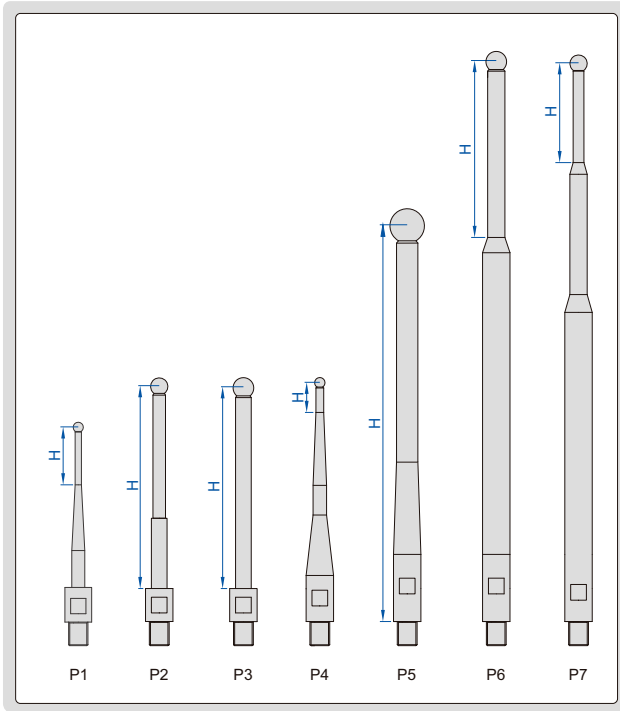

6558-52

- To locate workpieces
- Buzzer in EDM sounds when the ball touches the workpiece
- Tungsten steel ball, diameter accuracy: $\pm 0.003\text{mm}$
- Non magnetic stainless steel spindle
- Magnetic base

(mm)

Code	Ball dia. (SØD)	Spindle length (L)	Measuring depth (H)	Spindle type
6558-11	SØ1	69	5	P4
6558-21	SØ2	49	6	P1
6558-22	SØ2	69	6	P4
6558-23	SØ2	119	8	P4
6558-31	SØ3	48	6	P1
6558-32	SØ3	68	7	P4
6558-33	SØ3	118	10	P4
6558-41	SØ4	48	37	P3
6558-42	SØ4	68	57	P2
6558-43	SØ4	118	16	P4
6558-44	SØ4	168	28	P7
6558-51	SØ5	47	36	P3
6558-52	SØ5	67	56	P2
6558-53	SØ5	117	106	P2
6558-54	SØ5	167	46	P6
6558-61	SØ6	47	35	P3
6558-62	SØ6	67	56	P3
6558-63	SØ6	87	76	P3
6558-64	SØ6	117	107	P2
6558-65	SØ6	167	51	P6
6558-81	SØ8	46	46	P5
6558-82	SØ8	66	54	P3
6558-83	SØ8	116	105	P3
6558-84	SØ8	166	51	P6
6558-101	SØ10	45	34	P3
6558-102	SØ10	65	53	P3
6558-103	SØ10	115	114	P5
6558-104	SØ10	165	53	P6

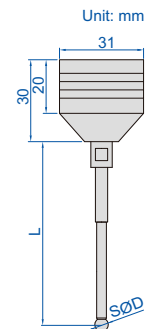

ZERO SETTER WITH CABLE (FIVE-SIDE) CODE 9412

IP68
WATERPROOF

- Suitable for various machining centers, CNC boring and milling machines, etc.
- Automatically set the tool length parameters before CNC machining process
- Automatic detection of tool wear or damage during CNC machining
- Automatic detection of tool wear or damage after CNC machining is completed
- The working surface adopts ceramic material and chamfering process, which can greatly improve the service life
- The plug, cable part and output signal of the host are protected, so that the zero setter can work in the splash environment for a long time
- Signal transmission through the cable, the reverse connection of the power line can change the state of the signal output
- The position of zero setter pillar can be roughly and precisely adjusted by the connecting link of the pillar and the adjusting link of zero setter for mounting
- The working status is displayed by the indicator light
- Supplied with automatic zero setter software package
- Optional accessory: square feeler block (code **9412-B1**)



SPECIFICATION

Height (factory setting)	80±0.5mm
Diameter of zero setter	12.7mm
Trigger direction	±X, ±Y, +Z
Trigger protection stroke	X-Y: ±5mm, Z: 8mm
Axial reset force	3.4N-3.6N
Repeated trigger accuracy	≤1μm
Hardness of the zero setter	HM8.5
Class of protection	IP68
Cable length *	6m (stainless steel sheath 3m)
Input voltage	24V±10% (DC)
Load current	max: 50mA
Signal type and logic **	SSR (NC/NO)

*The length of the cable can be customized

**Before purchasing, it is necessary to confirm whether the working logic of the tool setter output signal matches CNC control system

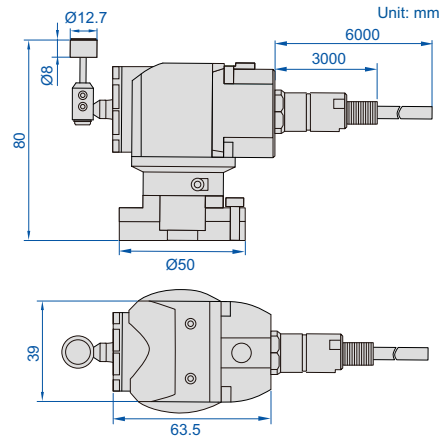

18

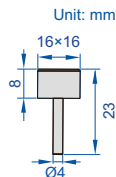

SQUARE FEELER BLOCK (OPTIONAL)

Code	Shape	Dimension	Material
9412-B1	square	16×16mm	ceramic

Automatic zero setter software package (included)

1. Automatic calibration of the center position of the cutter block
2. Standard knife length setting
3. Semi-automatic and fully automatic tool setting for tool length



4. Semi-automatic and fully automatic tool diameter settings



5. Automatic detection of tool wear and breakage



application



IP68
WATERPROOF

ZERO SETTER (WITH CABLE) CODE 9411

- Suitable for various machining centers, CNC boring and milling machines, etc.
- Automatically set the tool length parameters before CNC machining process
- Automatic detection of tool wear or damage during CNC machining
- Automatic detection of tool wear or damage after CNC machining is completed
- The working surface is made of hard alloy material, which can greatly improve the scratch resistance
- Signal transmission through the cable, the reverse connection of the power line can change the state of the signal output
- The working status is displayed by the indicator light
- Supplied with 20mm mounting base
- Supplied with automatic zero setter software package
- Optional accessory: blow-cleaning device (code 9411-C1)



SPECIFICATION

Height	80mm (the height is 100mm after adding the mounting base)
Diameter of zero setter	25mm
Downward travel	5mm
Axial reset force	6N±0.3N
Repeated trigger accuracy	≤1μm
Hardness of the zero setter	HRA90-93
Class of protection	IP68
Cable length *	6m (stainless steel sheath 3m)
Input voltage	24V±10% (DC)
Load current	max: 50mA
Signal type and logic **	SSR (NC/NO)

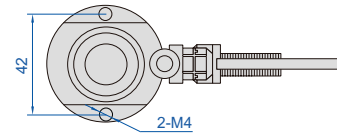
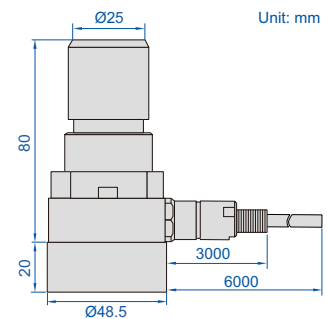

*The length of the cable can be customized

**Before purchasing, it is necessary to confirm whether the working logic of the tool setter output signal matches CNC control system

BLOW-CLEANING DEVICE (OPTIONAL)

Code	Material
9411-C1	stainless steel

Before purchasing a blow-cleaning device, it is necessary to confirm whether CNC machine has the M-code to control the cleaning

application



blow-cleaning device (optional)

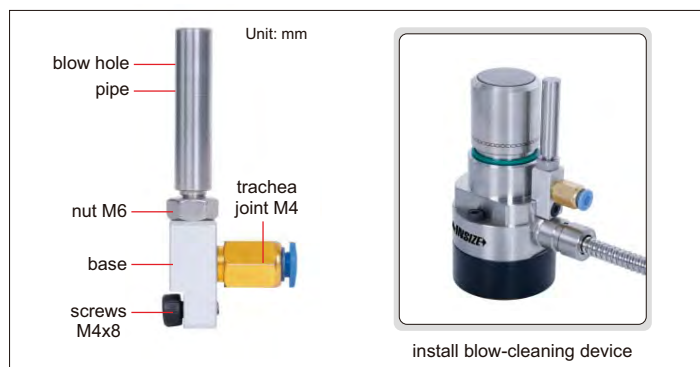

Automatic zero setter software package (included)

1. Automatic calibration of the center position of the cutter block
2. Standard knife length setting
3. Semi-automatic and fully automatic tool setting for tool length
4. Automatic detection of tool wear and breakage



ELECTRONIC ZERO SETTER

INSIZE PLUS
MADE IN EUROPE

- The base is electrically conducted to the cutting tools through the table and chuck. The LED lights up when the cutting tool touches the anvil
- Magnetic base
- Two batteries LR44

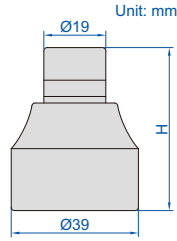

6553-50

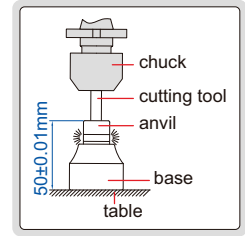
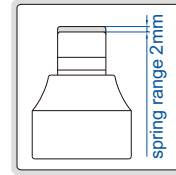

LOW TEST FORCE

Code	Height (H)	Accuracy	Test force
6553-50	50mm	±10µm	7N (at 49mm)

DIGITAL ZERO SETTER

IP65
WATERPROOF

- Resolution: 0.001mm/0.00005"
- IP65 dust/waterproof
- Buttons: on/off, mm/inch, zero
- CR2032 battery
- Automatic power off
- Magnetic base
- Automatic backlight at zero



6557-50

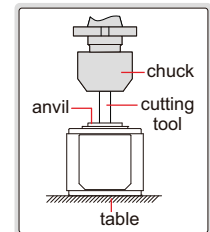
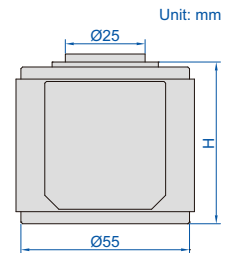

Code	Height (H)	Anvil stroke	Accuracy *	Test force	Repeatability
6557-50	50mm	2.5mm	±10µm/0.0004"	10N (at 50mm)	2µm

* The accuracy is ensured within Ø10mm of the center

ZERO SETTER

INSIZE PLUS
MADE IN EUROPE

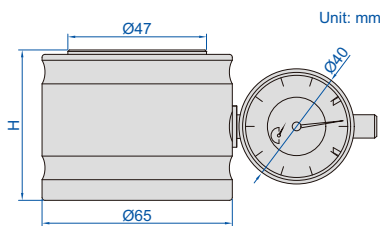

6554-50

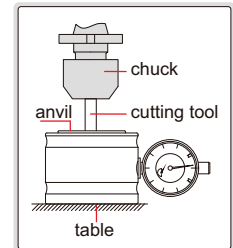

Code	Height (H)	Graduation	Accuracy	Test force
6554-50	50mm	0.01mm	±0.02mm	9N (at 50mm)

ZERO SETTER

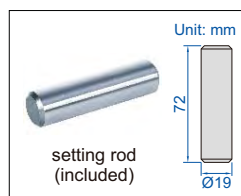
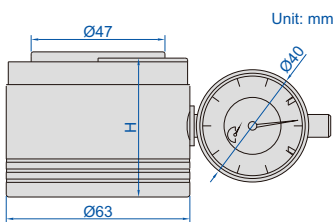

6556-50

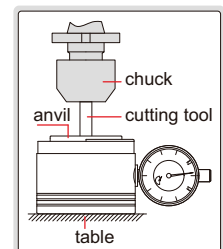

Code	Height (H)	Graduation	Accuracy	Test force
6556-50	50mm	0.01mm	±0.01mm	10N (at 50mm)

ZERO SETTER

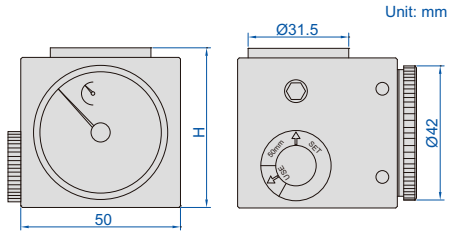

- Magnetic base



2397-502A

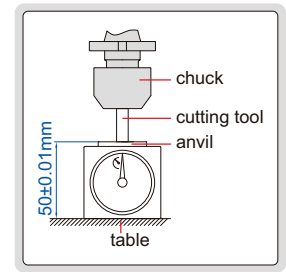

Code	Height (H)	Graduation	Accuracy	Test force
2397-502A	50mm	0.01mm	±0.01mm	9N (at 50mm)

ZERO SETTER

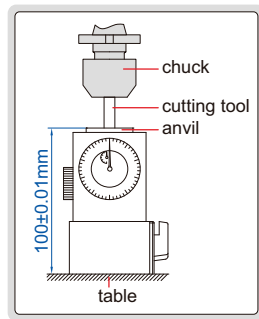

- Magnetic base with on-off switch



2394-100A

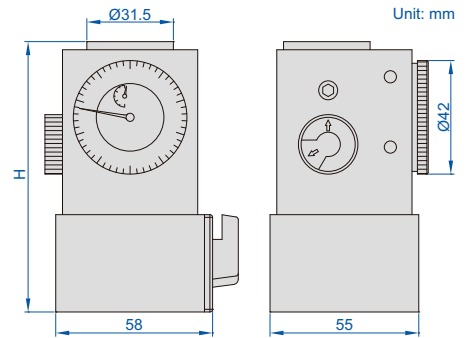

Code	Height (H)	Graduation	Accuracy	Test force
2394-100A	100mm	0.01mm	±0.01mm	9N (at 100mm)

LOW TEST FORCE

LOW TEST FORCE ZERO SETTER

INSIZE PLUS
MADE IN EUROPE

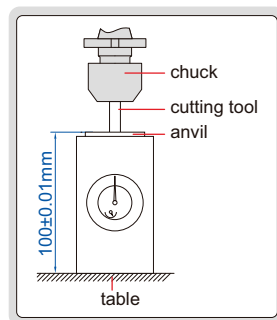

- Magnetic base
- Low test force, suitable for micro tools with minimum diameter Ø0.1mm



6555-100B

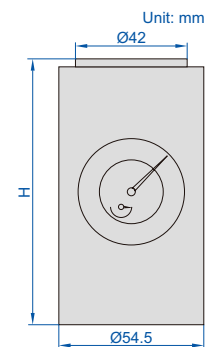

Code	Height (H)	Graduation	Accuracy	Test force
6555-100B	100mm	0.01mm	±0.01mm	1N (at 100mm)



Electronic Levels
Page 441



Digital Levels And Slope Meters
Page 442-445



Frame Levels
Page 446



Block Levels
Page 447



Digital Levels And Slope Meters
Page 448



Levels
Page 448-451



Cross-line Laser Levels
Page 452



Self-Leveling Rotary Lasers
Page 453



DATA OUTPUT

SHOCK PROOF

ELECTRONIC LEVELS

INSIZE PLUS
MADE IN EUROPE

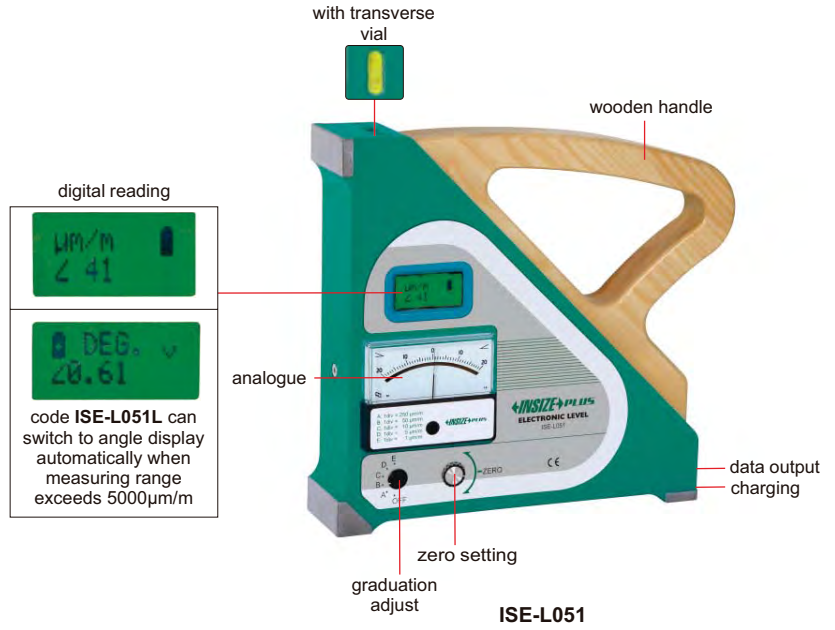
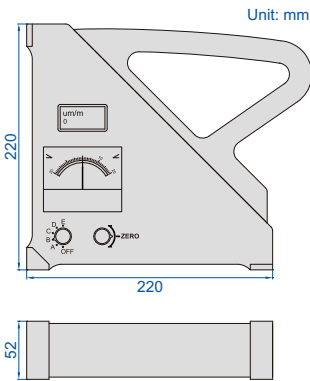

digital reading

code **ISE-L051L** can switch to angle display automatically when measuring range exceeds 5000μm/m

- Shockproof
- Analogue and digital reading modes

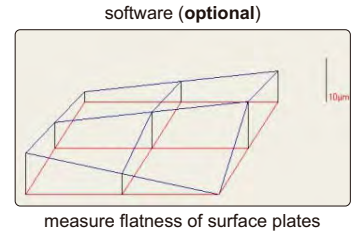
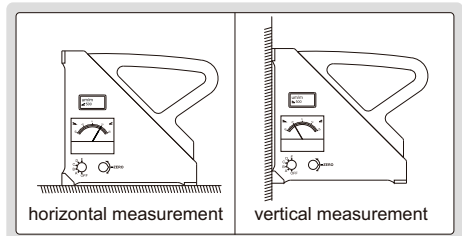

SPECIFICATION

Code	ISE-L051			ISE-L051L	
	250μm/m (=0.014°)	50μm/m (=10")	10μm/m (=2")	5μm/m (=1")	1μm/m (=0.2")
Analogue graduation (adjustable)	±5000μm/m	±1000μm/m	±200μm/m	±100μm/m	±20μm/m
Analogue range	horizontal: 1μm/m (=0.2")			horizontal: 1μm/m (=0.2"), angle: 0.01°	
Digital reading resolution	horizontal: 5000μm/m			horizontal: 5000μm/m, angle: 0.3~85°	
Digital reading range	horizontal: ±1%			horizontal: ±1%, angle: ±0.7%	
Accuracy	±1500μm/m				
Zero setting range	<3s				
Response time	RS232				
Data output	rechargeable Li-ion battery, provides power for 10h continuous working				
Power supply	220×220×52mm				
Dimension	4.4kg				
Weight					

STANDARD DELIVERY

Main unit	1 pc
AC/DC adapter	1 pc

OPTIONAL ACCESSORY

Software and data output cable	ISE-L050-SOFTWARE
--------------------------------	-------------------

DIGITAL LEVEL CODE ISE-2DT

DATA OUTPUT



- Color LCD, touch panel
- X-Y axis measurement
- Set the tolerance and the display is shown in different colors

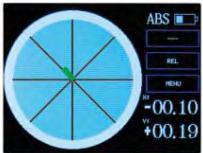

within the tolerance (green)

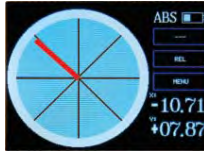

out of the tolerance (red)

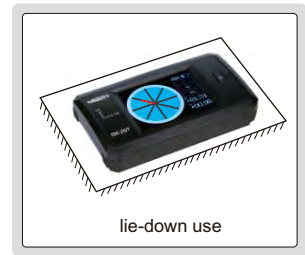

19

- To show the incline with line or bubble

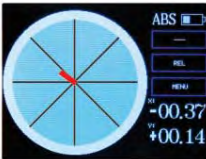

charging and data output

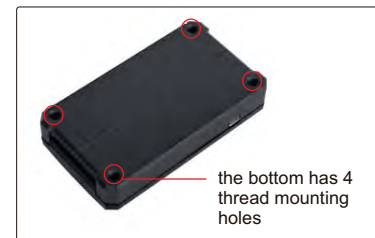

the bottom has 4 thread mounting holes

SPECIFICATION

Measuring range	±30°
Resolution	0.1°, 0.01°, 0.1mm/m
Accuracy	±0.03° (range 0~3°) ±0.05° (range >3°)
Power supply	rechargeable battery
Dimension	115×66×25mm
Weight	224g

STANDARD DELIVERY

Main unit	1 pc
USB cable	1 pc

OPTIONAL ACCESSORY

Software	ISE-2DT-SOFTWARE
----------	------------------

PC software (optional), send data to txt

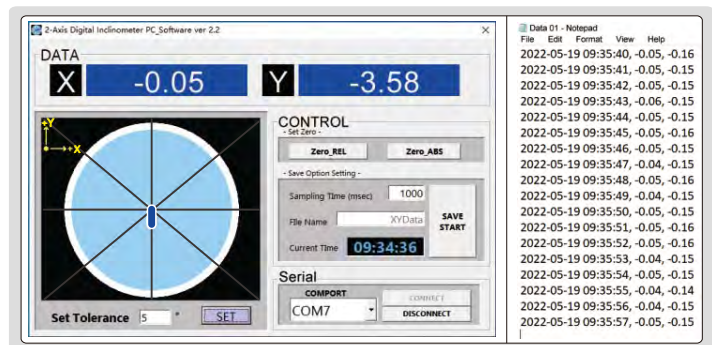

DUAL AXIS DIGITAL LEVEL AND GYRO ANGLE METER

DATA OUTPUT

DISPLAY FLIPS OVER WHEN THE BOTTOM FACES UP

AUDIBLE ALARM WHEN OUT OF LIMIT

BACKLIGHT

ATTENTION: HARD PLASTIC CASE



2199-1

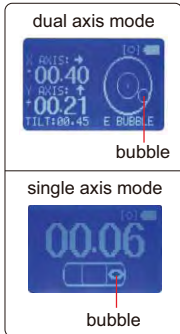
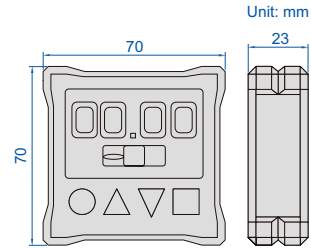

M4 threaded holes on the back for fixing

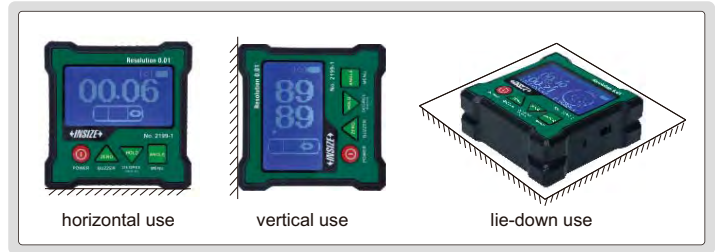

- Single axis/double axis level and slope meter, gyro technique can measure the angle between two planes in any direction
- Hard plastic case, with V-shaped grooves, four magnetic sides
- Display flips over when the bottom faces up
- Audible alarm when out of limit
- Buttons: POWER, ZERO, HOLD, display unit (°, mm/m, %), MENU
- Rechargeable Li-ion battery 3.7V, operation time is 40 hours
- Automatic power off in 30 minutes
- Data output
- Optional accessory: wired data transmission (code **2199-A01**), bluetooth (code **2199-A02**), transmission distance is 10 meters (under the condition of no obstruction and no electromagnetic interference)

measurement of angle between two planes in any direction (gyro technique)

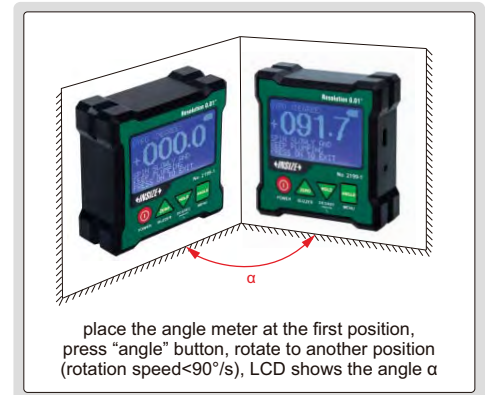

place the angle meter at the first position, press "angle" button, rotate to another position (rotation speed <math>< 90^\circ/s</math>), LCD shows the angle α

Code	Range	Resolution	Accuracy
2199-1	single axis level: 4x90° dual axis level: ±40°	0.01°	at 0° and 20°: ±0.05° at 20° and 70°: ±0.15° at 70° and 90°: ±0.05°
	gyro angle meter: 360°	0.1°	±0.5°



connect to computer via wired data transmission



connect to mobile phone via bluetooth



bluetooth (optional)



wired data transmission (optional)

DIGITAL LEVEL AND SLOPE METER

IP67
WATERPROOF

ABSOLUTE
LEVEL

BACKLIGHT

BUZZER ALARM
AT 0° AND 90°

WORKING TEMPERATURE
-5°C~50°C



2175-360

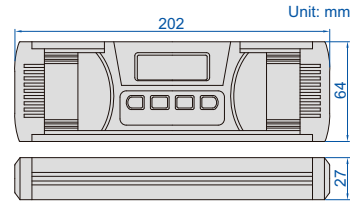

- IP67 dust/waterproof
- Used as level and slope meter
- Aluminum frame, shock absorbing rubber end caps
- Magnetic bottom with V-groove for shafts
- The sea level is permanently set inside the chip, zero setting is not needed when batteries are replaced
- Buttons: ON/OFF, backlight/buzzer alarm, absolute and incremental measurement, unit (mm/m, %, °), HOLD (keep the reading)
- Three AAA batteries, automatic power off

Code	Range	Resolution	Accuracy
2175-360	0-360° (90°x4)	0.05° (=0.873mm/m)	at 0°: ±0.05°; at others: ±0.1°

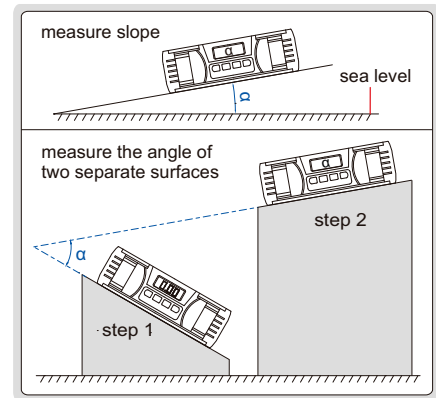

19 DIGITAL LEVEL AND SLOPE METER

IP54
WATERPROOF

ABSOLUTE
LEVEL

BACKLIGHT

BUZZER ALARM
AT 0° AND 90°

WORKING TEMPERATURE
-5°C~50°C



2179-360

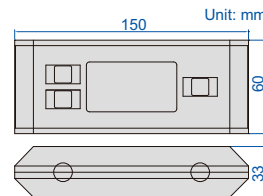

- IP54 dust/waterproof
- Used as level and slope meter
- Aluminum frame
- Magnetic bottom with V-groove for shafts
- The sea level is permanently set inside the chip, zero setting is not needed when battery is replaced
- Buttons: ON/OFF, absolute and incremental measurement, keep the reading, buzzer alarm, unit (mm/m, %, in/ft), conversion, backlight
- Two AAA batteries, automatic power off

Code	Range	Resolution	Accuracy
2179-360	0-360° (90°x4)	0.05° (=0.873mm/m)	at 0° and 90°: ±0.1°; at others: ±0.2°

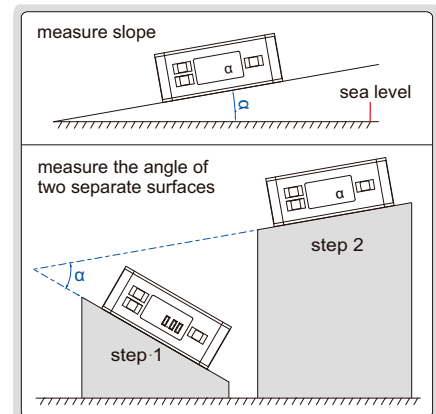

MAGNETIC BOTTOM

WORKING TEMPERATURE
-5°C~50°C

BACKLIGHT

DISPLAY FLIPS OVER WHEN THE BOTTOM FACES UP

ABSOLUTE LEVEL

DIGITAL LEVEL AND SLOPE METER

POPULAR MODEL



2170-1

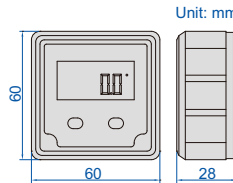

Unit: mm

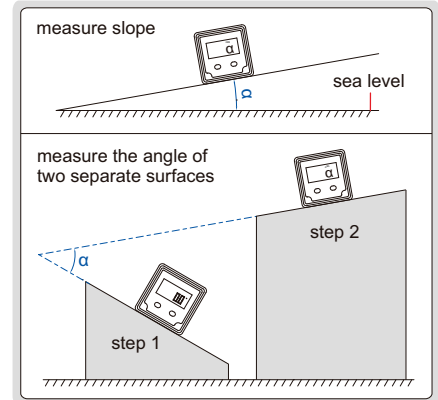

- Used as level and slope meter
- Aluminum frame
- Magnetic bottom
- The display flips over when the bottom faces up
- The backlight is on automatically when in use, and automatically off in 15 seconds after use
- The sea level is permanently set inside the chip, zero setting is not needed when battery is replaced
- Buttons: ON/OFF, ZERO, absolute and incremental measurement
- One AAA battery, automatic power off in 5 minutes

Code	Range	Resolution	Accuracy
2170-1	4x90°	0.1° (=1.745mm/m)	at 0° and 90°: ±0.1°; at others: ±0.2°



BLUETOOTH DIGITAL LEVEL AND SLOPE METER

BACKLIGHT

MAGNETIC BOTTOM

DISPLAY FLIPS OVER WHEN THE BOTTOM FACES UP

WORKING TEMPERATURE
-5°C~50°C

ABSOLUTE LEVEL



2198-2

- Used as level and slope meter
- Aluminum frame
- Magnetic bottom
- The display flips over when the bottom faces up
- The backlight is on automatically when in use, and automatically off in 15 seconds after use
- The sea level is permanently set inside the chip, zero setting is not needed when battery is replaced
- Buttons: ON/OFF, ZERO, HOLD, absolute and incremental measurement
- Built-in bluetooth, transmission distance is 15 meters (under the condition of no obstruction and no electromagnetic interference). Android and iPhone APP are included
- One AAA battery, automatic power off in 5 minutes

Android and iPhone APP (included), can choose real-time display (continuous transmission) or single transmission

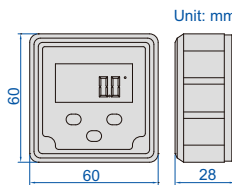
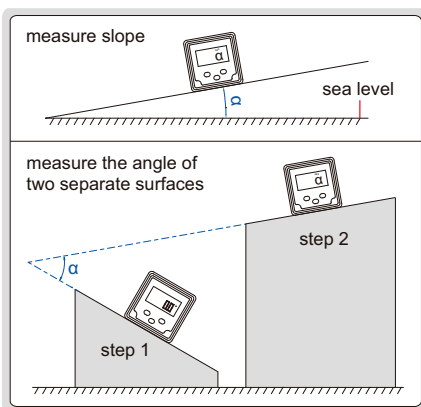

Unit: mm

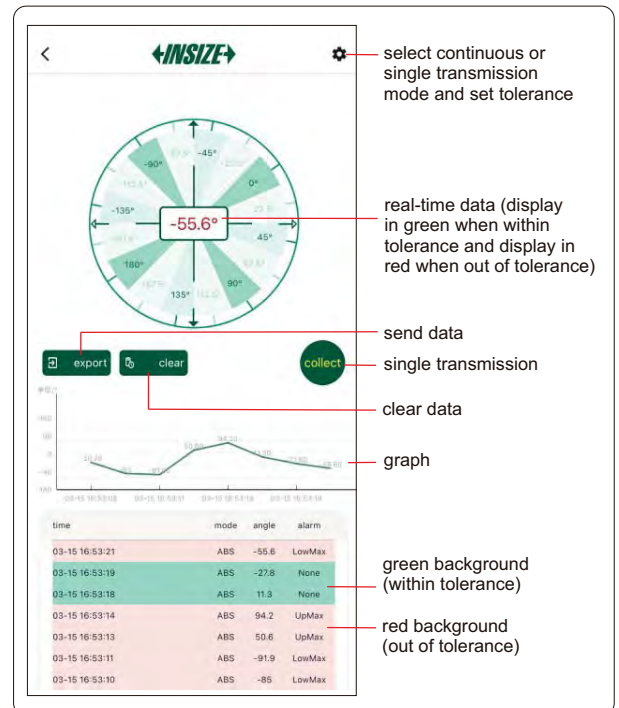

select continuous or single transmission mode and set tolerance

real-time data (display in green when within tolerance and display in red when out of tolerance)

send data

single transmission

clear data

graph

green background (within tolerance)

red background (out of tolerance)

Code	Range	Resolution	Accuracy
2198-2	4x90°	0.1° (=1.745mm/m)	at 0° and 90°: ±0.1°; at others: ±0.2°

FRAME LEVELS

INSIZE PLUS
MADE IN EUROPE

NO NEED TO SET
ZERO BEFORE USE



4906-150

magnet on the left side



4906-150M

- No need to set zero before use
- Three V-grooves for shafts (shafts dia. 19.3~115.9mm)
- With longitudinal vial

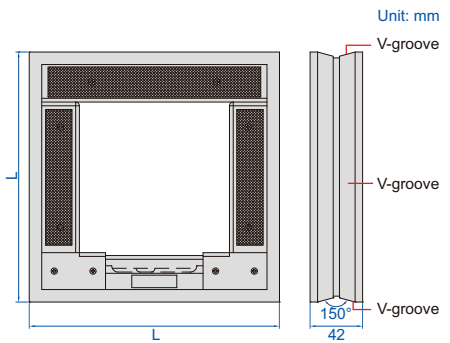

19

Code		Size (LxL)	Remark
Sensitivity 0.02mm/m (=0.001°)	Sensitivity 0.1mm/m (=0.0057°)		
4906-150	4906-B150	150x150mm	–
4906-200	4906-B200	200x200mm	–
4906-300	4906-B300	300x300mm	–
4906-150M	4906-B150M	150x150mm	with magnet
4906-200M	4906-B200M	200x200mm	with magnet
4906-300M	4906-B300M	300x300mm	with magnet

FRAME LEVELS



- V-groove on bottom and left for shafts (shafts dia. 15~68mm)
- With transverse vial

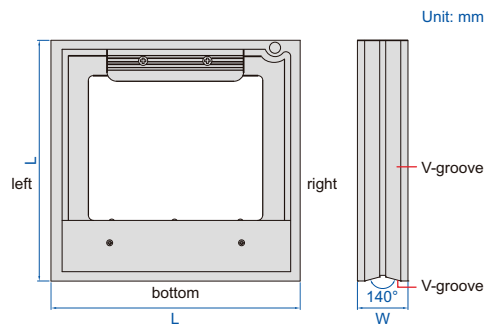

4902-200

Code		Size (LxL)	W
Sensitivity 0.02mm/m (=0.001°)	Sensitivity 0.05mm/m (=0.0029°)		
4902-150	4902-C150	150x150mm	40mm
4902-200	4902-C200	200x200mm	40mm
4902-300	4902-C300	300x300mm	45mm



NO NEED TO SET ZERO BEFORE USE

- No need to set zero before use
- V-groove on bottom for shafts (shafts dia. 19.3~115.9mm)
- With longitudinal vial



4905-200

BLOCK LEVELS
INSIZE PLUS
 MADE IN EUROPE

Code		Size (L)
Sensitivity 0.02mm/m (=0.001°)	Sensitivity 0.1mm/m (=0.0057°)	
4905-160	4905-B160	160mm
4905-200	4905-B200	200mm
4905-300	4905-B300	300mm
4905-500	4905-B500	500mm

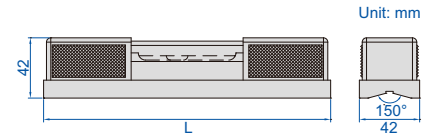

- V-groove on bottom for shafts (shafts dia. 15~68mm)
- With transverse vial

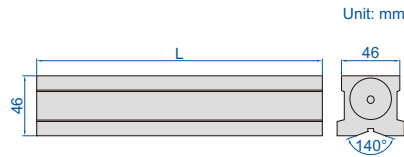

4903-200A

BLOCK LEVELS

Code		Length (L)
Sensitivity 0.02mm/m (=0.001°)	Sensitivity 0.05mm/m (=0.0029°)	
4903-150A	4903-C150	150mm
4903-200A	4903-C200	200mm
4903-300A	4903-C300	300mm

19

NO NEED TO SET ZERO BEFORE USE

- No need to set zero before use
- Suitable for small spaces like crankshaft
- Longitudinal and transverse V-grooves on bottom for shafts (shafts dia. 19.3~115.9mm)
- With transverse vial



4907-90

SHORT LEVEL
INSIZE PLUS
 MADE IN EUROPE

Code	Length	Sensitivity
4907-90	90mm	0.1mm/m (=0.0057°)

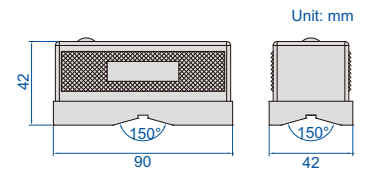

NO NEED TO SET ZERO BEFORE USE

- No need to set zero before use
- With mounting holes (for M5 screws)



4908-100

MINI LEVEL
INSIZE PLUS
 MADE IN EUROPE

Code	Length	Sensitivity
4908-100	100mm	0.1mm/m (=0.0057°)

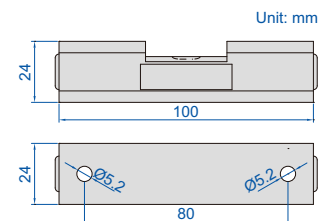

DIGITAL LEVELS AND SLOPE METERS

ABSOLUTE LEVEL

BACKLIGHT

WORKING TEMPERATURE
0°C ~ 50°C

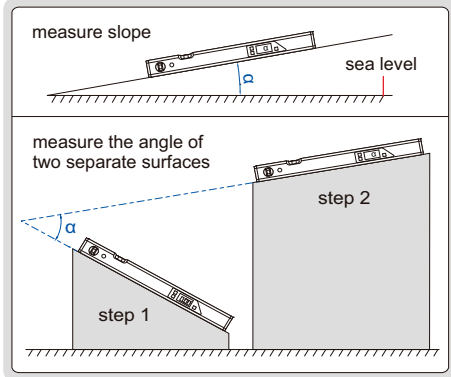

4910-400



4910-600

- With transverse and longitudinal vials
- Used as level and slope meter
- Aluminum frame, magnetic bottom
- The sea level is permanently set inside the chip, zero setting is not needed when batteries are replaced
- Buttons: ON/OFF, absolute and incremental measurement, keep the reading, buzzer alarm (not for 4910-400), unit (mm/m, %, in/ft), conversion (not for 4910-400), backlight
- The display flips over when the bottom faces up
- Two AAA batteries
- Automatic power off

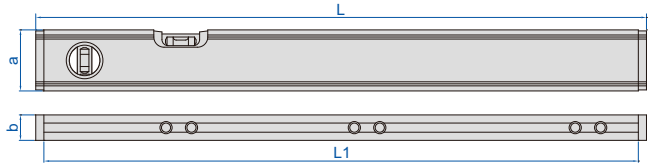

19

Code	Range	Resolution	Accuracy	Remark	L	L1	a	b
4910-400	0~360° (90°×4)	angle: 0.1°; slope: 1mm/m	±0.2°	both angle and slope are displayed	416	400	50	21
4910-600	0~360° (90°×4)	at 0° and 90°: 0.05° (=0.8725mm/m); at others: 0.1° (=1.745mm/m)	at 0° and 90°: ±0.1°; at others: ±0.2°	at 0° and 90° buzzer alarms	600	585	60	25

HANDY LEVEL

magnetic base surface



4912-100

- Shockproof vials
- Magnetic base
- Shock absorbing rubber end caps
- Working temperature: -15°C~55°C

Code	Size (L)	Accuracy
4912-100	100mm	0.5mm/m

LIFETIME WARRANTY VIALS

MAGNETIC BASE

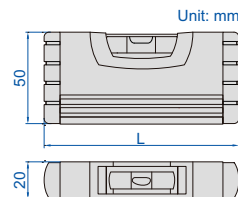

packaging



MAGNETIC BASE

LIFETIME WARRANTY VIALS

HANDY LEVELS



4922-100

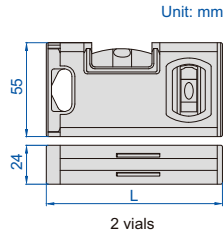

4922-150

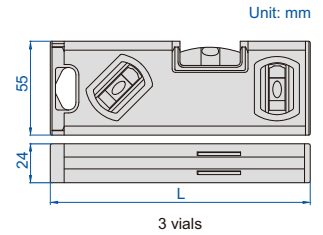

Code	Size (L)	Accuracy	Number of vials
4922-100	100mm	0.5mm/m	2
4922-150	150mm	0.5mm/m	3
4922-200	200mm	0.5mm/m	3

- Shockproof horizontal and vertical vials
- Magnetic base
- Shock absorbing rubber end caps
- Working temperature: -15°C–55°C

MAGNETIC BASE

LIFETIME WARRANTY VIALS

CASTING ALUMINUM LEVEL

magnetic bottom surface (milled)



4913-250

packaging



19

- Shockproof horizontal and vertical vials
- Magnetic base
- Working temperature: -15°C–55°C
- Casting aluminum body

Code	Size (L)	Accuracy
4913-250	250mm	0.5mm/m

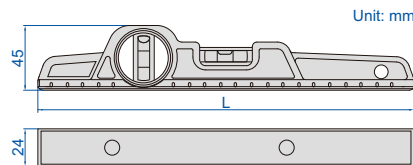

MAGNETIC BASE

LIFETIME WARRANTY VIALS

ALUMINUM LEVEL

- Shockproof horizontal and vertical vials
- Magnetic base
- Shock absorbing rubber end caps
- Working temperature: -15°C–55°C



4921-230

Code	Size (L)	Accuracy
4921-230	230mm	0.5mm/m

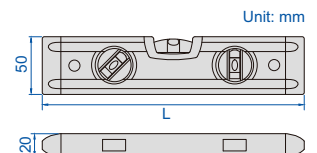

ALUMINUM LEVELS

LIFETIME WARRANTY VIALS

MAGNETIC BASE



4914-600

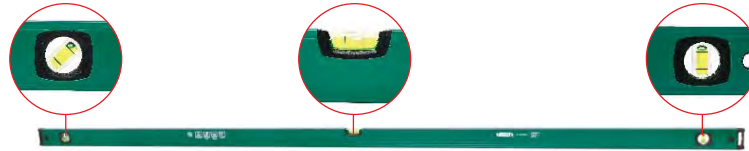

4914-2000

- Shockproof horizontal and vertical vials
- Magnetic base
- Shock absorbing rubber end caps
- Working temperature: -15°C~55°C

Code	Size (L)	Accuracy	Number of vials
4914-300	300mm	0.5mm/m	2
4914-600	600mm	0.5mm/m	2
4914-800	800mm	0.5mm/m	2
4914-1000	1000mm	0.5mm/m	2
4914-1200	1200mm	0.5mm/m	2
4914-2000	2000mm	0.5mm/m	3

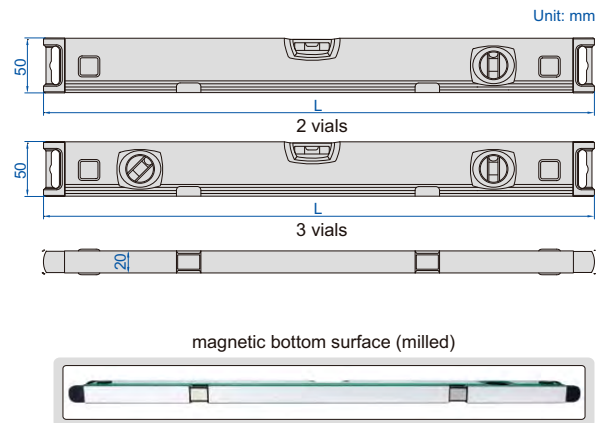

ALUMINUM LEVELS

LIFETIME WARRANTY VIALS

- Top and bottom working surfaces
- Shock-proof and UV-proof vials
- Die casting aluminum alloy frame
- Zero position of horizontal vial can be set
- One graduation of horizontal vial is 2% slope
- Working temperature: -15°C~55°C



4911-600

bottom surface (non-magnetic, milled)

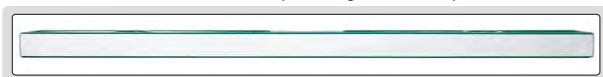

Code	Size (L)	Accuracy
4911-600	600mm	0.5mm/m
4911-800	800mm	0.5mm/m

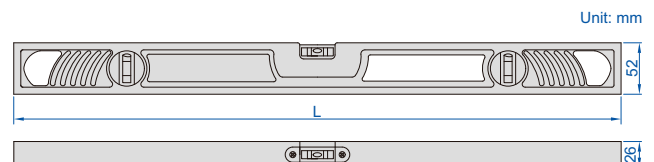

MAGNETIC BASE

LIFETIME WARRANTY VIALS

ALUMINUM LEVELS (BASIC TYPE)



4918-300

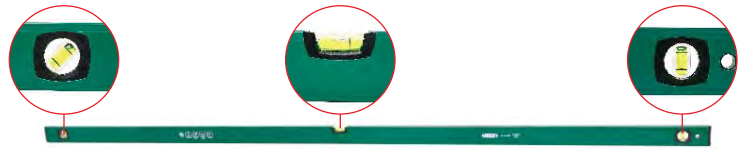

4918-2000

Code	Size (L)	Accuracy	Number of vials
4918-300	300mm	1mm/m	2
4918-600	600mm	1mm/m	2
4918-800	800mm	1mm/m	2
4918-1000	1000mm	1mm/m	2
4918-1200	1200mm	1mm/m	2
4918-2000	2000mm	1mm/m	3

- Shock-proof and UV-proof vials
- Magnetic base
- Shock absorbing rubber end caps
- Working temperature: -15°C~55°C

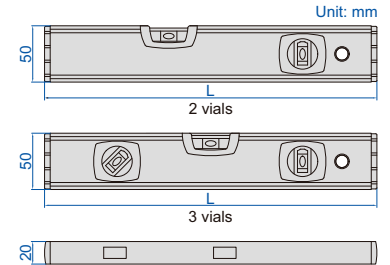
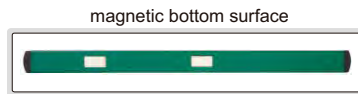

LIFETIME WARRANTY VIALS

ALUMINUM LEVELS (WITH ROTARY VIAL)

- Shockproof and UV-proof vials
- Horizontal, vertical and rotary vials
- Rotary vial, range: 0°~360°, graduation: 5°
- Plumb window
- Shock absorbing rubber end caps
- Working temperature: -15°C~55°C

Code	Size (L)	Accuracy
4920-400	400mm	0.5mm/m
4920-600	600mm	0.5mm/m
4920-800	800mm	0.5mm/m
4920-900	900mm	0.5mm/m
4920-1000	1000mm	0.5mm/m
4920-1200	1200mm	0.5mm/m

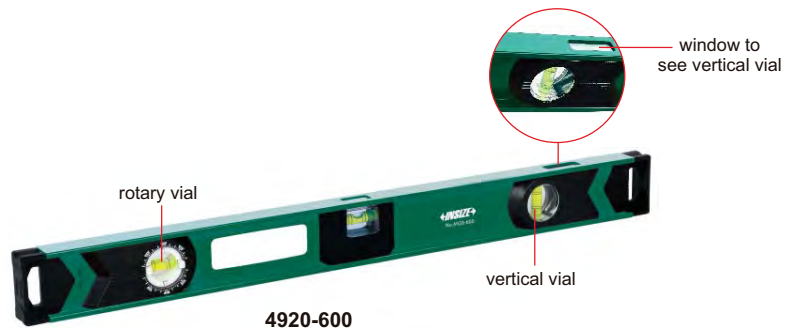

4920-600

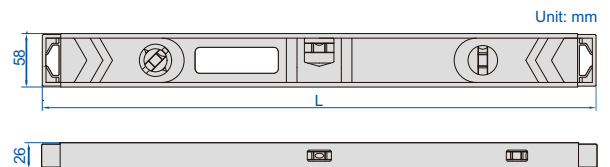

LIFETIME WARRANTY VIALS

ALUMINUM LEVEL WITH RULER

- Shockproof horizontal and vertical vials
- Non-magnetic milled base
- Shock absorbing rubber end caps
- Range of ruler: 0-60cm, graduation: 1mm
- Working temperature: -15°C~55°C

Code	Size (L)	Accuracy
4923-600	600mm	0.5mm/m



4923-600

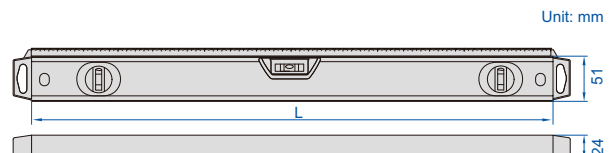

CROSS-LINE LASER LEVEL CODE 4917-30

IP54
WATERPROOF

AUDIBLE AND VISUAL
ALARM WHEN OUT OF $\pm 3^\circ$



- Red horizontal and vertical cross laser lines
- Self-leveling within $\pm 3^\circ$, self-leveling time within 4s, audible and visual alarm when out of $\pm 3^\circ$
- Folding legs for angle and height adjustment
- Outdoor use with the detector (code: **4917-DETECTOR**)



application examples



folding legs for angle and height adjustment

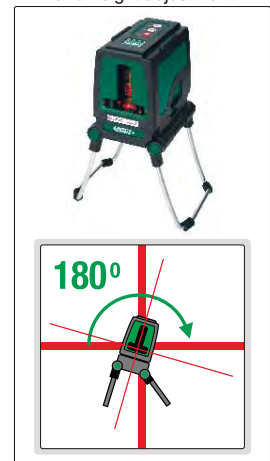

SPECIFICATION

Laser line width	2±0.5mm (within 5m)
Laser type	630~660nm, class II, <1mW
Beam angle	120±0.5°
Self-leveling range	±3°
Working distance	indoor: 30m, outdoor: 50m with detector (optional)
Accuracy	0.2mm/m
Operation temperature	-10~40°C
Power supply	3×AA batteries, for 3 hours working
Dimension	100×82×104mm
Weight	620g

OUTDOOR DETECTOR (OPTIONAL)

Detecting distance	horizontal 1~50m, vertical 1~30m
Detecting accuracy *	high accuracy ±1.5mm, low accuracy ±2.5mm
Power supply	9V battery
Dimension	168×58×30mm
Weight	140g (battery included)

* Use high accuracy detection mode within 15m, use low accuracy detection mode over 15m



stand
(included with outdoor detector)



outdoor detector (optional)

STANDARD DELIVERY

Main unit	1 pc
1/4" to 5/8" tripod adaptor	1 pc
Battery (AA)	3 pcs

OPTIONAL ACCESSORY

Outdoor detector	4917-DETECTOR
------------------	---------------

INDICATOR FLASHING
WHEN OUT OF $\pm 5^\circ$

IP65
WATERPROOF

SELF-LEVELING ROTARY LASER CODE GRL-L340



detector (included)



remote controller (included)



bracket for C battery (included)



beam finder glasses (included)



tripod (included)

- Applicable fields: construction, decoration, pipeline and equipment installation
- Green laser beam rotates 360° horizontally or vertically
- Self-leveling range $\pm 5^\circ$ on both X and Y planes
- Alarm when inclination is out of $\pm 5^\circ$
- $\pm 5^\circ$ leveling range for manual mode on both X and Y planes
- 5 variable speeds 0-600rpm
- 6 scan modes
- Plumb up and plumb down dots
- Remote control for long distance
- Power supply: AC or DC

application examples



horizontal leveling

vertical leveling

working with detector

SPECIFICATION

Working range	indoor 50m, outdoor 300m (with detector)	
Self leveling range	$\pm 5^\circ$	
Horizontal/vertical beam accuracy	$\pm 0.1\text{mm/m}$	
Main laser type	520~540nm, class 2, <1mW	
Auxiliary laser type	645~655nm, class 2, <1mW	
Rotating speed	0/60/120/300/600rpm	
Scanning range	0/10/45/90/180/360°	
Setting slope	X axis: $\pm 5^\circ$, Y axis: $\pm 5^\circ$	
Operation temperature	-20~50°C	
Maximum remote control distance	20m	
Power supply	remote controller	2×1.5V AAA batteries
	main unit	NI-MH batteries or 4×1.5V C batteries
	detector	1x9V battery
Dimension	210×210×213mm	
Weight	2.5kg	

STANDARD DELIVERY

Main unit (including NI-MH batteries)	1 pc
C battery and bracket	1 set
Detector	1 pc
Remote controller	1 pc
Beam finder glasses	1 pc
Laser target	1 pc
Power adapter	1 pc
AAA battery	2 pcs
9V battery	1 pc
Tripod	1 pc



Linear Scales
Page 455-457/459



Digital Readouts
Page 458-459

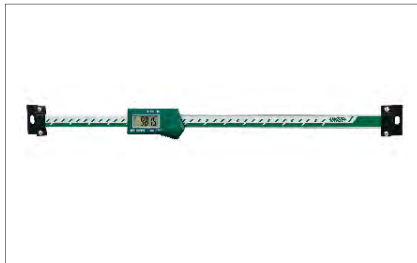

Scales
Page 460



Air Gages And Displays
Page 461



Laser Scan Micrometers
Page 462-463



Spectrometers
Page 464-468

LINEAR SCALES (TTL SIGNAL)



ISL-A1-300

Series ISL-A1 and ISL-A5

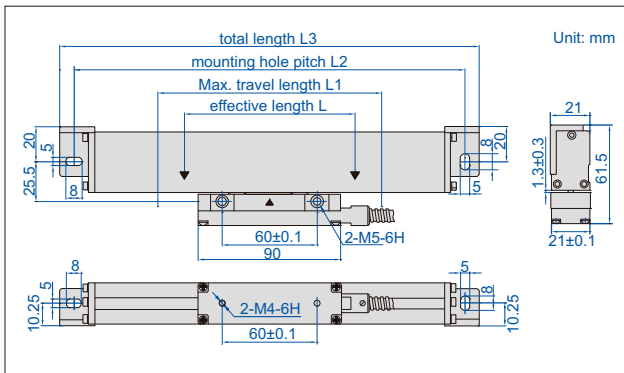

Series ISL-B5

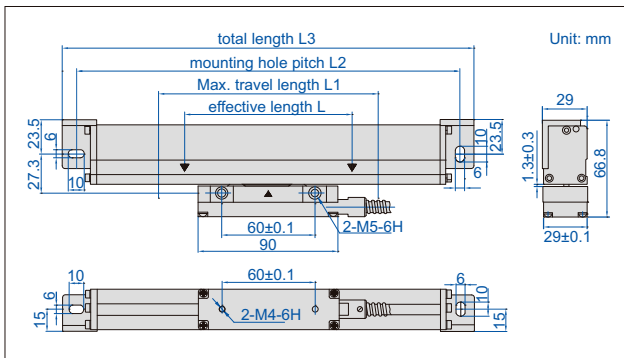

Effective length (L)	Code		
	Thin type		Thick type
	Series ISL-A1	Series ISL-A5	Series ISL-B5
50mm	ISL-A1-50	ISL-A5-50	ISL-B5-50
100mm	ISL-A1-100	ISL-A5-100	ISL-B5-100
150mm	ISL-A1-150	ISL-A5-150	ISL-B5-150
200mm	ISL-A1-200	ISL-A5-200	ISL-B5-200
250mm	ISL-A1-250	ISL-A5-250	ISL-B5-250
300mm	ISL-A1-300	ISL-A5-300	ISL-B5-300
350mm	ISL-A1-350	ISL-A5-350	ISL-B5-350
400mm	ISL-A1-400	ISL-A5-400	ISL-B5-400
450mm	ISL-A1-450	ISL-A5-450	ISL-B5-450
500mm	ISL-A1-500	ISL-A5-500	ISL-B5-500
550mm	ISL-A1-550	ISL-A5-550	ISL-B5-550
600mm	ISL-A1-600	ISL-A5-600	ISL-B5-600
650mm	ISL-A1-650	ISL-A5-650	ISL-B5-650
700mm	ISL-A1-700	ISL-A5-700	ISL-B5-700
750mm	ISL-A1-750	ISL-A5-750	ISL-B5-750
800mm	ISL-A1-800	ISL-A5-800	ISL-B5-800
850mm	ISL-A1-850	ISL-A5-850	ISL-B5-850
900mm	ISL-A1-900	ISL-A5-900	ISL-B5-900
950mm	ISL-A1-950	ISL-A5-950	ISL-B5-950
1000mm	ISL-A1-1000	ISL-A5-1000	ISL-B5-1000
1100mm			ISL-B5-1100
1200mm			ISL-B5-1200
1300mm			ISL-B5-1300
1400mm			ISL-B5-1400
1500mm			ISL-B5-1500
1600mm			ISL-B5-1600
1700mm			ISL-B5-1700
1800mm			ISL-B5-1800
1900mm			ISL-B5-1900
2000mm			ISL-B5-2000
2100mm			ISL-B5-2100
2200mm			ISL-B5-2200
2300mm			ISL-B5-2300
2400mm			ISL-B5-2400
2500mm			ISL-B5-2500
2600mm			ISL-B5-2600
2700mm			ISL-B5-2700
2800mm			ISL-B5-2800
2900mm			ISL-B5-2900
3000mm			ISL-B5-3000
3100mm			ISL-B5-3100
3200mm			ISL-B5-3200

STANDARD DELIVERY

Main unit	1 pc
'L' shape support	1 pc
Anti-dust cover	1 pc
Plain base	1 pc (for L≥1500mm)
Mounting accessories	1 package

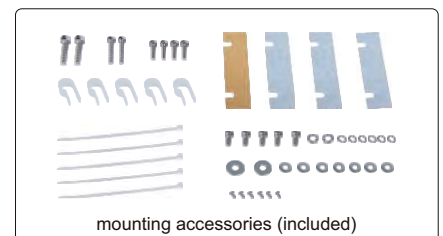
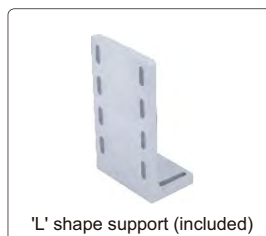

To be continued

Continued from previous page



anti-dust cover (included)

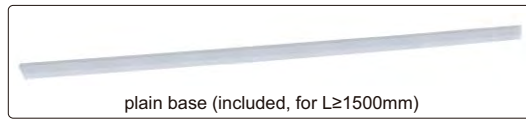

plain base (included, for $L \geq 1500\text{mm}$)

SPECIFICATION

Code	Series ISL-A1		Series ISL-A5		Series ISL-B5	
L1 (mm)	L+30 ($L \leq 900$)	L+50 ($L > 900$)	L+30 ($L \leq 900$)	L+50 ($L > 900$)	L+30 ($L \leq 900$)	L+50 ($L > 900$)
L2 (mm)	L+132 ($L \leq 900$)	L+152 ($L > 900$)	L+132 ($L \leq 900$)	L+152 ($L > 900$)	L+136 ($L \leq 900$)	L+156 ($L > 900$)
L3 (mm)	L+148 ($L \leq 900$)	L+168 ($L > 900$)	L+148 ($L \leq 900$)	L+168 ($L > 900$)	L+154 ($L \leq 900$)	L+174 ($L > 900$)
Resolution	1 μm		5 μm		5 μm	
Max. response speed	50m/min		90m/min		60m/min	
Scale grating pitch	20 μm					
Scale reference point pitch	50mm					
Accuracy	$\pm(5+5L/1000)\mu\text{m}$ L is the effective length in mm					
Cable length	3.5m (L: 50-950mm), 5m (L: 1000-1500mm), 10m (L: 1600-3200mm)					
Output signal	TTL					
Socket	9PD					
Power supply	5 \pm 0.5V					

LINEAR SCALES (RS422 SIGNAL)



ISL-B5-450A

- Connected to digital display box or PLC

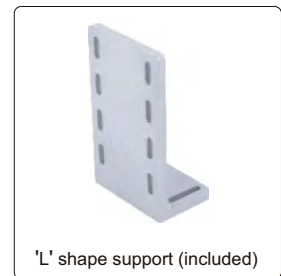
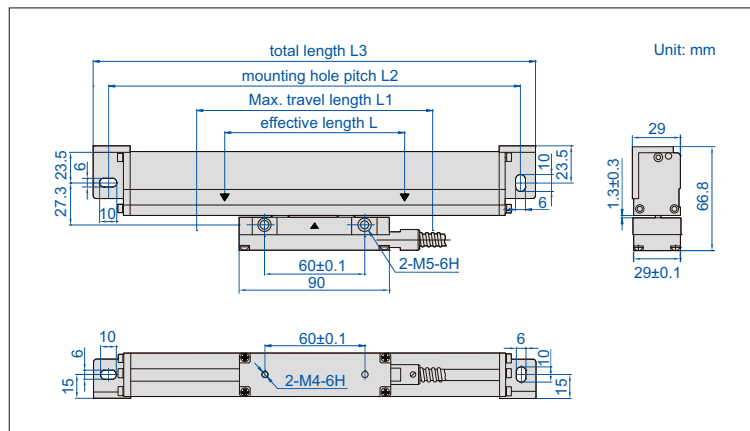

'L' shape support (included)

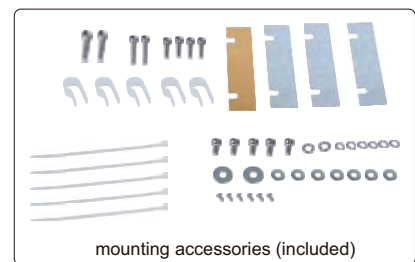

mounting accessories (included)

To be continued

Continued from previous page

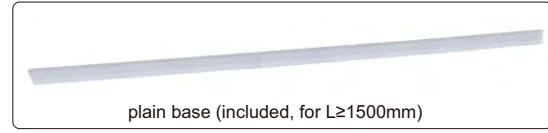

Effective length (L)	Code	
	Series ISL-B1	Series ISL-B5
50mm	ISL-B1-50A	ISL-B5-50A
100mm	ISL-B1-100A	ISL-B5-100A
150mm	ISL-B1-150A	ISL-B5-150A
200mm	ISL-B1-200A	ISL-B5-200A
250mm	ISL-B1-250A	ISL-B5-250A
300mm	ISL-B1-300A	ISL-B5-300A
350mm	ISL-B1-350A	ISL-B5-350A
400mm	ISL-B1-400A	ISL-B5-400A
450mm	ISL-B1-450A	ISL-B5-450A
500mm	ISL-B1-500A	ISL-B5-500A
550mm	ISL-B1-550A	ISL-B5-550A
600mm	ISL-B1-600A	ISL-B5-600A
650mm	ISL-B1-650A	ISL-B5-650A
700mm	ISL-B1-700A	ISL-B5-700A
750mm	ISL-B1-750A	ISL-B5-750A
800mm	ISL-B1-800A	ISL-B5-800A
850mm	ISL-B1-850A	ISL-B5-850A
900mm	ISL-B1-900A	ISL-B5-900A
950mm	ISL-B1-950A	ISL-B5-950A
1000mm	ISL-B1-1000A	ISL-B5-1000A

Effective length (L)	Code	
	Series ISL-B1	Series ISL-B5
1100mm	ISL-B1-1100A	ISL-B5-1100A
1200mm	ISL-B1-1200A	ISL-B5-1200A
1300mm	ISL-B1-1300A	ISL-B5-1300A
1400mm	ISL-B1-1400A	ISL-B5-1400A
1500mm	ISL-B1-1500A	ISL-B5-1500A
1600mm	ISL-B1-1600A	ISL-B5-1600A
1700mm	ISL-B1-1700A	ISL-B5-1700A
1800mm	ISL-B1-1800A	ISL-B5-1800A
1900mm	ISL-B1-1900A	ISL-B5-1900A
2000mm	ISL-B1-2000A	ISL-B5-2000A
2100mm	ISL-B1-2100A	ISL-B5-2100A
2200mm	ISL-B1-2200A	ISL-B5-2200A
2300mm	ISL-B1-2300A	ISL-B5-2300A
2400mm	ISL-B1-2400A	ISL-B5-2400A
2500mm	ISL-B1-2500A	ISL-B5-2500A
2600mm	ISL-B1-2600A	ISL-B5-2600A
2700mm	ISL-B1-2700A	ISL-B5-2700A
2800mm	ISL-B1-2800A	ISL-B5-2800A
2900mm	ISL-B1-2900A	ISL-B5-2900A
3000mm	ISL-B1-3000A	ISL-B5-3000A

SPECIFICATION

Code	Series ISL-B1	Series ISL-B5
L1 (mm)	L+30 (L≤900), L+50 (L>900)	L+30 (L≤900), L+50 (L>900)
L2 (mm)	L+136 (L≤900), L+156 (L>900)	L+136 (L≤900), L+156 (L>900)
L3 (mm)	L+154 (L≤900), L+174 (L>900)	L+154 (L≤900), L+174 (L>900)
Resolution	1µm	5µm
Thickness	29mm	
Max. response speed	60m/min	
Scale grating pitch	20µm	
Scale reference point pitch	50mm	
Accuracy	±(5+5L/1000)µm, L is the effective length in mm	
Cable length	3.5m (L: 50-950mm), 5m (L: 1000-1900mm), 10m (L: 2000-3000mm)	
Output signal	RS422	
Socket	9 PD	
Power supply	5±0.25V	

STANDARD DELIVERY

Main unit	1 pc
'L' shape support	1 pc
Anti-dust cover	1 pc
Plain base	1 pc (for L ≥ 1500mm)
Mounting accessories	1 package

DIGITAL READOUTS

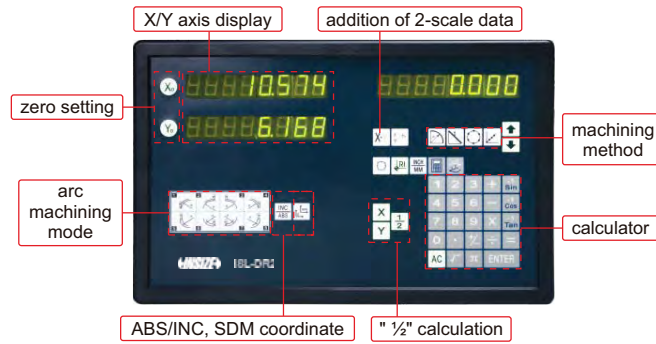

ISL-DR2

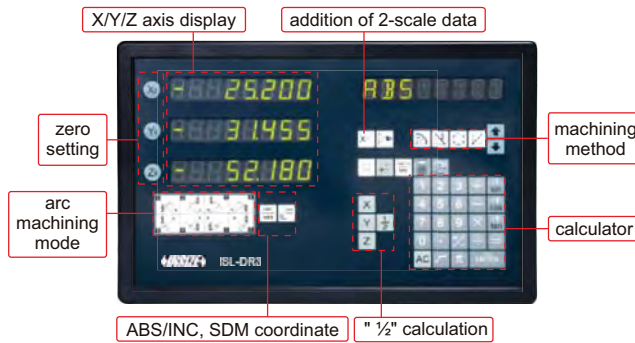

ISL-DR3



software flash disk (included)

- For ISL-A1, ISL-A5, ISL-B1, ISL-B5 series linear scales

SPECIFICATION

Code	ISL-DR2	ISL-DR3
Application	two-axis	three-axis
Scale input ports	2	3
Resolution	0.05µm, 0.1µm, 0.2µm, 0.5µm, 1µm, 2µm, 5µm, 10µm, 20µm, 50µm	
Functions	addition of 2-scale data, linearity error compensation, smoothing, RS232C interface unit, BCD code out, zero setting, preset, resolution setting, counting direction setting, inch/mm conversion, ABS/INC conversion, expansion/contraction coefficient setting, "1/2" calculation, detecting RI, bolt-hole circle machining, ramp circle machining	
Power supply	110/220V, 50/60Hz	
Dimension	295×185×45mm	
Weight	1.45kg	

STANDARD DELIVERY

Main unit	1 pc
Mounting bracket	1 pc
Ground cable	1 pc
RS232C cable	1 pc
Software flash disk for RS232C	1 pc

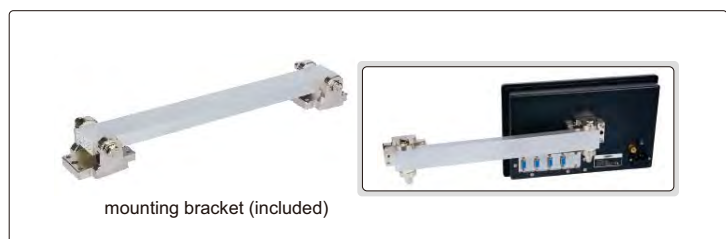

LINEAR SCALE AND READOUT SET FOR LATHE CODE ISL-SET1



software flash disk
(included)

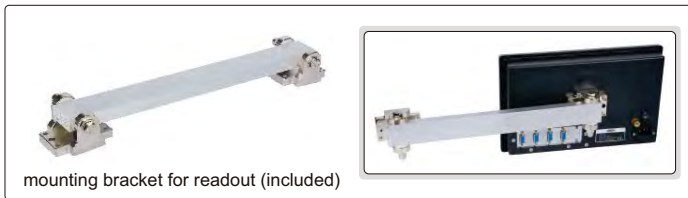
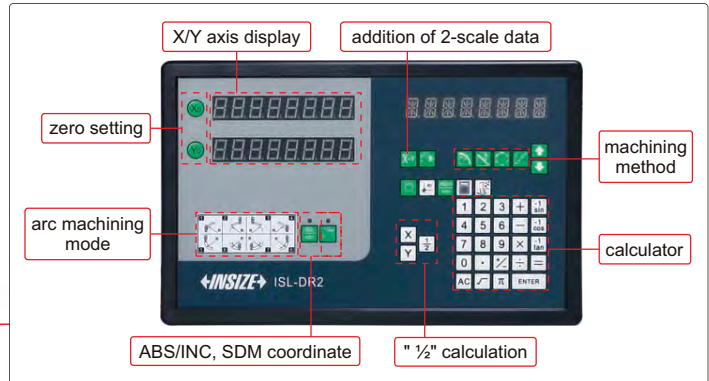

mounting bracket for readout (included)

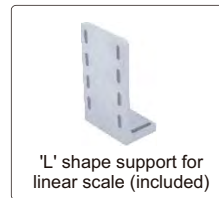

'L' shape support for
linear scale (included)



anti-dust cover for linear scale (included)

READOUT SPECIFICATION

Application	two-axis
Scale input ports	2
Resolution	1 μ m
Functions	addition of 2-scale data, linearity error compensation, smoothing, RS232C interface unit, BCD code out, zero setting, preset, resolution setting, counting direction setting, inch/mm conversion, ABS/INC conversion, expansion/contraction coefficient setting, "1/2" calculation, detecting RI, bolt-hole circle machining, ramp circle machining
Power supply	110/220V, 50/60Hz
Dimension	295×185×45mm
Weight	1.45kg

LINEAR SCALE SPECIFICATION

X-axis	200mm
Y-axis	1000mm
Max. response speed	50m/min
Scale grating pitch	20 μ m
Scale reference point pitch	50mm
Accuracy	$\pm(5+5L/1000)\mu$ m L is the effective length in mm
Cable length	200mm scale: 3.5m, 1000mm scale: 5m

STANDARD DELIVERY

Readout box	1 pc
200mm linear scale	1 pc
1000mm linear scale	1 pc
Mounting bracket for readout	1 pc
Ground cable for readout	1 pc
RS232C cable for readout	1 pc
Software flash disk for RS232C of readout	1 pc
'L' shape support for linear scale	1 pc
Anti-dust cover for linear scale	1 pc
Mounting accessories for linear scale	1 package

DIGITAL HORIZONTAL SCALES

DATA OUTPUT



7101-300A



7101-400A

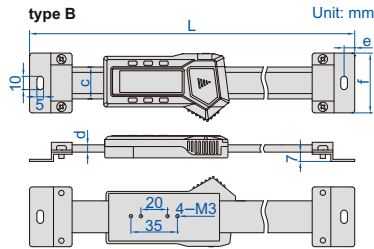
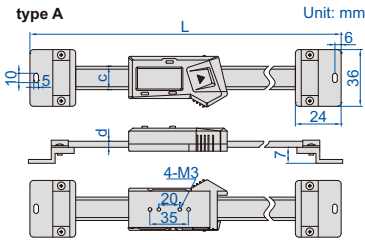

- Non waterproof
- Resolution: 0.01mm/0.0005"
- Buttons type A: on/off, zero, mm/inch, type B: on/off, zero, mm/inch, ABS, data preset
- Automatic power off, move the digital unit to turn on power
- Battery CR2032
- Data output
- Made of stainless steel
- Supplied with bracket to be mounted on the back

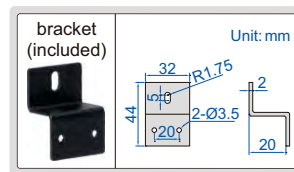

example of application

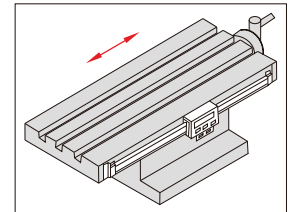

With data interface (data output cable code 7315-21 page 4, 7302-21 page 12, 7305-21 page 8, optional) (mm)

Code	Range	Type	Accuracy	L	c	d
7101-100A	100mm	A	±0.02mm	215	16	4
7101-150A	150mm	A	±0.03mm	265	16	4
7101-200A	200mm	A	±0.03mm	315	16	4
7101-300A	300mm	A	±0.04mm	445	16	4

With data interface (data output cable code 7315-22 page 4, 7302-22 page 12, 7305-22 page 8, optional) (mm)

Code	Range	Type	Accuracy	L	c	d	e	f
7101-400A	400mm	B	±0.05mm	590	24	5.5	8	45
7101-500A	500mm	B	±0.05mm	690	24	5.5	8	45
7101-600A	600mm	B	±0.08mm	790	24	5.5	8	45
7101-800A	800mm	B	±0.10mm	990	24	5.5	8	45
7101-1000A	1000mm	B	±0.10mm	1240	31	10.5	10	60

DIGITAL VERTICAL SCALES

DATA OUTPUT

- Non waterproof
- Resolution: 0.01mm/0.0005"
- Buttons: on/off, zero, mm/inch, ABS/INC, data hold, TOL, set
- Battery LR44, data output
- Made of stainless steel
- Supplied with bracket to be mounted on the back
- Optional accessory: wireless transmitter (code 7315-1150 page 6), data output cable (code 7302-SPC7 page 13, keyboard format), data output cable (code 7305-1150 page 9, serial port format)

example of application

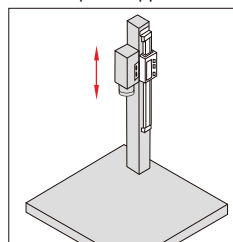

7102-300

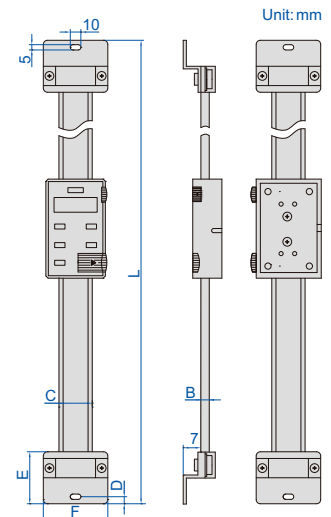



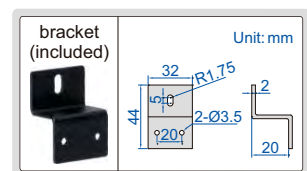

Code	Range	Accuracy	B	C	D	E	F	L
7102-100	100mm/4"	±0.02mm	4	20	6	24	40	245
7102-150	150mm/6"	±0.03mm	4	20	6	24	40	296
7102-200	200mm/8"	±0.03mm	4	20	6	24	40	345
7102-300	300mm/12"	±0.04mm	4	20	6	24	40	445
7102-400	400mm/16"	±0.05mm	4	20	6	24	40	545
7102-500	500mm/20"	±0.05mm	5.5	24	8	32	45	685
7102-600	600mm/24"	±0.08mm	5.5	24	8	32	45	785
7102-800	800mm/32"	±0.10mm	5.5	24	8	32	45	985
7102-1000	1000mm/40"	±0.10mm	10.5	31	9.5	40	60	1245





CUSTOM-MADE

**AIR GAGES
CODE 9401-PB**

<p>air plug gage and standard rings</p>  <p>measure diameter of hole, range: Ø4~230mm</p>	<p>air ring gage and standard plain plug gages</p>  <p>measure diameter of shaft, range: Ø4~160mm</p>	<p>air snap gage and standard column gages</p>  <p>measure diameter of shaft, range: Ø15~160mm</p>	<p>air taper gage and standard gages</p> 
--	--	--	--

DATA OUTPUT

 <p>air filter (optional)</p>	 <p>pressure regulating valve (optional)</p>
 <p>foot switch (optional)</p>	 <p>RS485 cable (optional)</p>

- Can store 10 measuring programs, and the program can be switched quickly
- Data storage function, support manual and automatic storing, 1500 groups data can be stored

**AIR GAGE DISPLAY
CODE 9408-QD100**

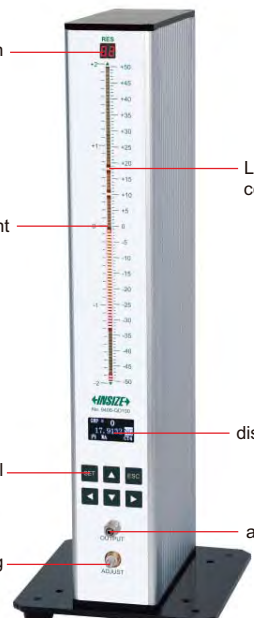

resolution

zero point

key panel

rate regulating valve

LED column

display

air outlet

back of display

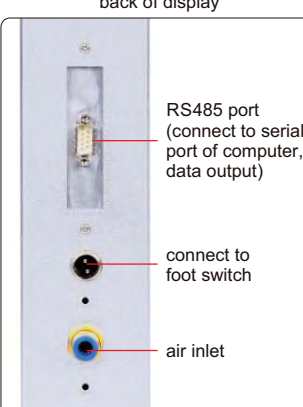

RS485 port (connect to serial port of computer, data output)

connect to foot switch

air inlet

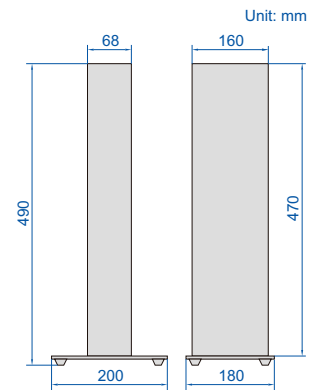

SPECIFICATION

LED quantity	101 pcs			
LED color	red, orange, green			
LED height	254mm			
Range, resolution and accuracy	range	resolution		accuracy
		LED	display	
	10µm	0.1µm	0.1µm	0.2µm
	20µm	0.2µm	0.1µm	0.4µm
	50µm	0.5µm	0.1µm	1µm
100µm	1µm	0.1µm	2µm	
Unit	mm, µm			
Air supply	dry and clean, 0.4~0.8MPa			
Data interface	RS485			
Operation temperature	-20~45°C			
Power supply	110~220V, 50/60Hz			
Dimension (L×W×H)	200×180×490mm			
Weight	4.5kg			

STANDARD DELIVERY

Main unit	1 pc
-----------	------

OPTIONAL ACCESSORY

Air filter	9401-FILTER-A
Pressure regulating valve	9404-PRV
RS485 cable	9408-CB
Foot switch	9408-FS
Data output cable (keyboard format)	7302-9408

LASER SCAN MICROMETERS

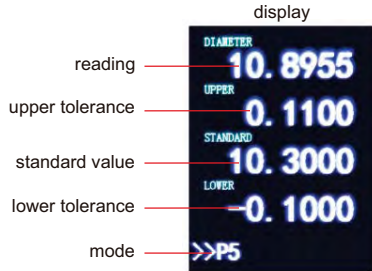

- Measure external diameter, ellipticity, run-out, maximum diameter of tools, etc.
- Can be used for transparent or non transparent workpieces
- Tolerance measurement
- Online or offline measurement
- Connected with computer and PLC

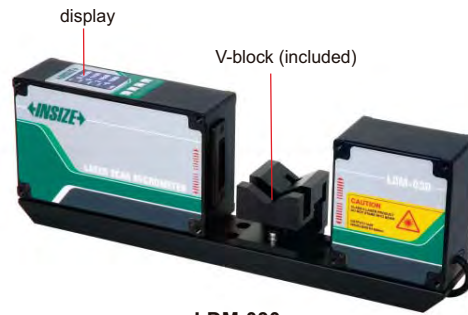

LDM-030

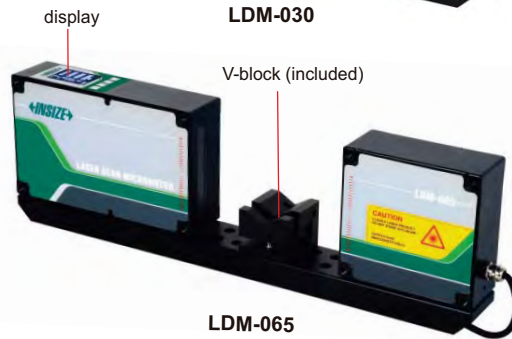

LDM-065

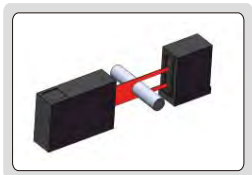

measure external diameter

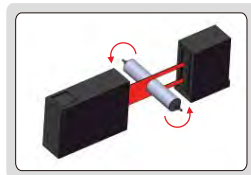

measure ellipticity and run-out

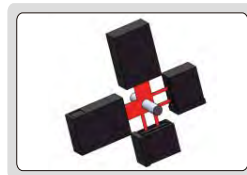

two-axis measurement

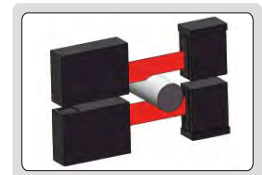

large size measurement

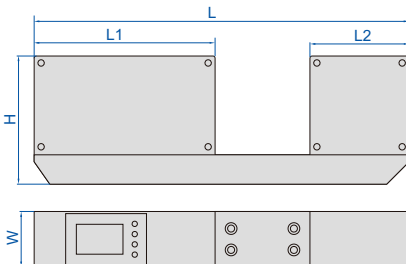

Dimension (mm)

Code	LDM-030	LDM-065
L	351	469
W	52	52
H	120	146
L1	170	203
L2	95	131



calibration gage (optional)

SPECIFICATION

Code	LDM-030	LDM-065
Measuring range	0.1~30mm	0.5~65mm
Resolution	0.01/0.1/1/10/100µm selectable	
25°C accuracy	±(0.5+10%D)µm, D is measuring diameter in mm	
Repeatability	±(0.3+5%D)µm, D is measuring diameter in mm	
Laser wave length	650nm	
Measuring speed	800~3200times/s (adjustable)	
Operation temperature	0~50°C	
Operation humidity	35~85RH without condensation	
Output	dual channel RS485	
Alarm output	24V, 1A	
Power supply	DC24V, 2A	
Dimension (L×W×H)	351×52×120mm	469×52×146mm
Weight	5kg	8kg

STANDARD DELIVERY

Main unit	1 pc
V-block	1 pc
AC/DC adapter	1 pc
RS485 cable	1 pc

OPTIONAL ACCESSORY

Calibration gage	custom made
------------------	-------------



LASER SCAN MICROMETER CODE LDM-D090



calibration gage (optional)

- Can measure the width and thickness of flat cables and tapes
- Can measure the outer diameter of cables, pipes and wires
- Laser scanning technology, large measurement range, high accuracy, high repeatability
- Connected with PLC and PC with RS485 interface
- Use high-precision F (θ) mirror, the swing of the measured object does not affect the measurement

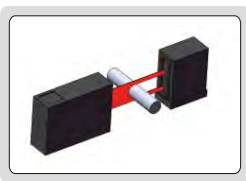

measure external diameter

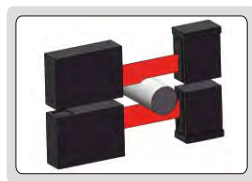

large size measurement

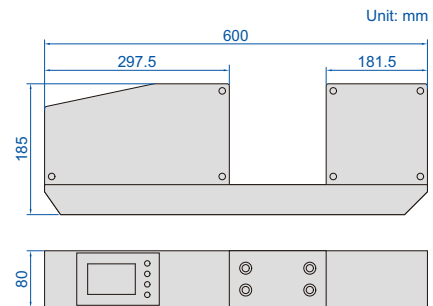

SPECIFICATION

Measuring range	0.5~90mm
Resolution	1μm
25°C accuracy	±(5+20%D)μm, D is measuring diameter in mm
Repeatability	±(3+20%D)μm, D is measuring diameter in mm
Laser wave length	650nm
Measuring speed	600 times/s
Operation temperature	5~45°C
Operation humidity	≤80%RH without condensation
Output	RS485/MODBUS protocol
Alarm output	24V, 1A
Power supply	AC85V~220V (50~60Hz)
Dimension (L×W×H)	600×80×185mm
Weight	6.5kg

STANDARD DELIVERY

Main unit	1 pc
V-block	1 pc
AC/DC adapter	1 pc
RS485 cable	1 pc

OPTIONAL ACCESSORY

Calibration gage	custom made
------------------	-------------

SPECTROMETER CODE OES-T350



CUSTOMIZE
CAN CUSTOMIZE OTHER METAL MATRIX DETECTION,
SUCH AS: Fe (004-009), Al, Cu, Zn, Ti, Ni, Pb, etc



printer (included)



filter element (included)



electrode brush (included)



single-phase AC voltage
regulator (included)



pressure valve (included)



calibration sample (included)



gray iron control sample
(optional)



15# carbon steel control
sample (optional)

- The standard machine can do analysis Fe 001-003
- The full-spectrum technology covers the full range of element analysis, which can determine trace amounts of carbon (C), phosphorus (P), sulfur (S) and other elements
- The analysis speed is fast, and the element composition of all channels is measured within 20 seconds
- Paschen-Runge structure with full wavelength coverage, the most concise and stable optical system structure
- Perfect aberration correction, so that the spectrometer has excellent resolution, minimize the cross interference of different elements
- Argon-filled optical chamber, effectively reducing the attenuation of P and S rays in the far ultraviolet region
- The software has automatic spectrum correction technology, can store database, trace historical data, output and print reports
- Report format can be customized, data can be sent out

To be continued



Continued from previous page

SPECIFICATION

Optical system	optical structure	paschen-runge structure
	rowland circle of diameter	350mm
	wavelength range	160~510nm
	detector	multi high resolution CCD detectors
	pixel resolution	20pm
	full spectrum	cover the full range of element analysis
	light room temperature	34±0.5°C (be controlled automatically)
Spark source	type	digital arc and spark source/new plasma generator
	spark frequency	100~1000Hz
	plasma current	1~80A
	ignition voltage	>7000V
Spark stand	spray discharge electrode technology reduces argon consumption and improves argon use efficiency	
	good heat dissipation, continuous excitation for 100 times, the temperature of the excitation table does not rise more than 5°C	
Others	measurable elements	Fe base, Al base, Cu base, Zn base, etc
	operation temperature	10~30°C, 23±2°C is recommended
	operation humidity	20%~80%RH
	power	AC220V/50Hz
	power consumption	excitation: 300W, stand by: 40W
	argon quality	99.999% high purity argon, argon pressure≥4MPa
	argon consumption	5L/min during spark mode
	dimension (LxWxH)	700x660x340mm
weight	30kg	

STANDARD DELIVERY

Main unit	1 pc
Computer	1 pc
Software	1 pc
Printer	1 pc
Calibration sample	1 pc
Electrode brush	2 pcs
Filter element	2 pcs
Single-phase AC voltage regulator	1 pc
Pressure valve	1 pc

OPTIONAL ACCESSORY

Control sample	custom specifications
Argon cylinder	OES-T350-ARGON
Grinding prototype	code: OES-T350-GRIND for ferrous metal sample preparation
Small lathe	code: OES-T350-LATHE for non-ferrous metal sample preparation
Argon purifier	OES-T350-PURIFIER

X RAY FLUORESCENCE SPECTROMETER (RoHS DETECTOR/ALLOY COMPOSITION ANALYZER/COATING THICKNESS GAGE) CODE XRF-B210



CALIBRATION CURVE CAN BE CUSTOMIZED
ACCORDING TO CUSTOMER REQUIREMENTS

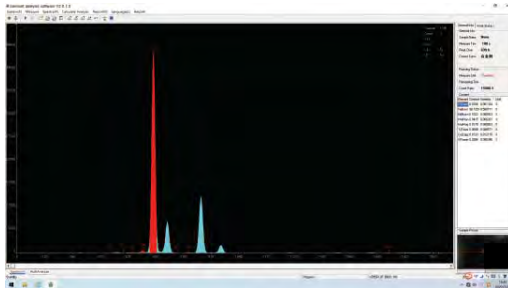

alloy composition analysis software (included)

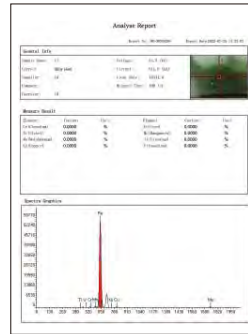

alloy composition analysis report (included)

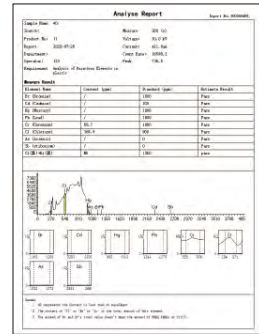

RoHS test report (included)

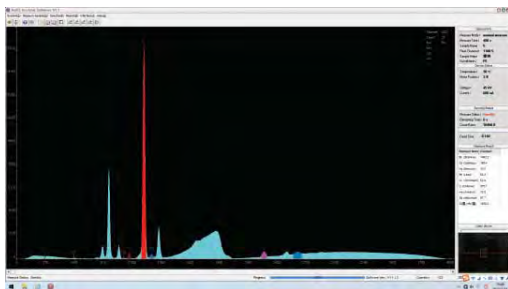

RoHS test software (included)



coating thickness test report (included)



coating thickness detection software (included)

To be continued



Continued from previous page

- Used for RoHS detection, alloy element analysis, coating thickness measurement
- Using SI-PIN detector with electric cooling, small size, accurate data analysis and low maintenance cost
- Seven optical path correction and collimation system, automatically switch according to different samples
- Multiple radiation leakage prevention design
- The temperature monitoring technology ensures the safe and reliable operation of the X-ray source
- Dedicated software, standard window design, friendly interface, easy to operate
- Can display multiple spectrograms at the same time and print multiple report forms
- USB3.0 interface to ensure accurate, high-speed and efficient data transmission

SPECIFICATION

Detector	type	Si-PIN electrical refrigeration semiconductor detector	
	resolution	149±5 EV	
	amplifier circuit module	detect the sample characteristic X-ray, further enlarge the information collected by detection	
X ray excitation device	maximum output current	1mA	
	power	50W, air cooling	
High and low voltage power	maximum output voltage	50KV, built-in voltage overload protection	
	minimum output voltage	5KV	
Multi-channel pulse amplitude analyzer		maximum channel number: 4096	
Optical path filter module		reduce interference light path in the process of sending x-rays, guarantee the accuracy of the detector signal	
		Integrate the collimator with the filter	
Collimator automatic switching module		7 kinds, Ø0.5~Ø8mm	
Filter automatic switching module		5 kinds(free to choose and switch)	
RoHS analysis software	elemental analysis range	S~U	
	harmful element analysis	Cd, Pb, Hg, Br, Cr, Cl, As, Sb	
	test time	60~200s	
	detection limit	2PPM	
	content analysis range	2PPM~99.9%	
Alloy analysis software	elemental analysis range	Ti~U	
	detection limit	100PPM	
	content analysis range	100PPM~99.9%	
	repeatability	0.1%	
	stability	0.1%	
Metal coating analysis software	elemental analysis range	Ti~U	
	detection limit	0.01µm	
	analysis thickness	single layer thickness	0.01~30µm
		3 layer thickness	≤10µm
	repeatability	0.1µm (for outside coating less than 1µm)	
	stability	0.1µm (for outside coating less than 1µm)	
light spot	within 0.2mm		
Operation temperature		10~30°C	
Relative humidity		10%~90%	
Power		AC 220V±5V	
Dimension (L×W×H)		700×460×370mm	
Weight		49kg	

STANDARD DELIVERY

Main unit	1 pc
Standard sample	1 pc
Silver calibration	1 pc
Sample cup	2 pcs
Test film	50 pcs
Computer	1 pc
Printer	1 pc
Collimator (built-in)	7 pcs
Software	RoHS test software, alloy composition analysis software, coating thickness detection software

HAND-HELD SPECTROMETER CODE HSM-A310

IP54
WATERPROOF



test

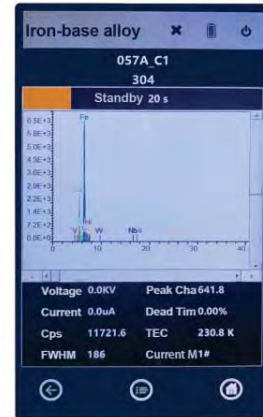

analysis

- Fast and non-destructive test to identify alloy grade and composition
- For all kinds of high and low temperature alloy steel, stainless steel, tool steel, chromium/molybdenum steel, nickel alloy, cobalt alloy, nickel/cobalt heat resistant alloy, titanium alloy
- Multiple tests, it can automatically calculate maximum value, minimum value and standard deviation
- IP54 dust/waterproof



SPECIFICATION

Excitation source	50KV/200µA; Ag target, integrated end window, micro X-ray tube and high voltage power supply, matching power ≥4W
Detector	Si-PIN, window area 25mm ²
Elemental analysis range	Ti, V, Cr, Mn, Fe, Co, Ni, Cu, Zn, Se, Zr, Nb, Mo, Rh, Pd, Ag, Cd, Sn, Sb, Hf, Ta, W, Re, Pb, Bi
Alloy analysis mode	1. automatically identify alloy grade 2. alloy material qualified test mode
Collimator filter	7 groups
Display	5-inch LCD touch screen
CPU	quad-core processor, 1.4GHz, 4G memory
Memory	built-in 64G, storage data, >500000 groups
Data transmission	built-in WIFI, U disk, bluetooth (support bluetooth printer)
Data export format	EXCEL, BMP, PDF, CSV
Battery	6800mAh lithium battery, for 8 hours working time
Air pressure compensation	built-in pressure measurement module for system compensation and correction
System	Win-IOT operation system
Work environment	temperature: 0~40°C, relative humidity: 10%~90%
Dimension	250x320x80mm
Weight	1.9kg

STANDARD DELIVERY

Main unit	1 pc
Charger	1 pc
Battery	2 pcs
Test film	50 pcs
Sample cup	1 pc
Standard sample	1 pc
Protection support (including calibration silver)	1 pc
USB and cable	1 pc



standard sample (included)



protection support (included)



Digital Ultrasonic Flaw Detectors
Page 470-471



Portable Magnetic Powder Flaw Detectors
Page 472



Rechargeable UV Flaw Detection Lights
Page 473



Penetration Standard Test Blocks
Page 473

DIGITAL ULTRASONIC FLAW DETECTOR CODE UFD-T680



- The all-aluminum metal shell is strong and durable, and the electromagnetic shielding performance is very good
- Tempered glass panel, extremely hard, wear-resistant and scratch-resistant
- Full-digital multi-color high resolution (640×480 pixels) TFT LCD display
- 4 operation interface styles can be selected according to the environment
- Real-time screenshots of all pages and flaw detection reports, and save them as BMP pictures to U disk
- Export the flaw detection report as a PDF file
- Unique Fn multifunction key design
- There is no limit of the number and duration of video recording through U disk
- Memory of 500 channel files to store calibration setups and probe parameter
- Memory of 1000 wave report files to store A-Scan wave and settings
- Two fully independent gates offer a range of measurement options for signal height or distance using peak triggering
- Can choose to set the incoming wave alarm or lost wave alarm, accompanied by LED light display
- Selectable frequency ranges (automatically set by the instrument) to match probe for optimum performance
- The unique automatic gain adjustment and gain scanning function make flaw detection fast and accurate



straight-beam probe
(included)



angle-beam probe
(included)



USB disk
(included)



couplant (included)

FUNCTIONS

Flaw detection standard	built-in common flaw detection standards, direct call, convenient and fast
Auto calibration	automatic calibration of probe zero offset, probe angle (K value) and material velocity
Peak hold	compare frozen peak waveforms to live A-Scans to easily interpret test result
Flaw locating	live display sound-path, projection (surface distance), depth, amplitude
Flaw discrimination	automatic flaw sizing using AVG or DAC, speeds reporting of defect acceptance or rejection
Flaw sizing	the equivalent dB value of defects or equivalent size of defects are displayed in real time
Curved surface correction	used for flaw detection of curved workpiece, it can display the circumferential position of defects in real time
DAC/AVG	the curve is automatically generated, and the sampling points can be compensated and corrected. The curve automatically floats with the gain, automatically expands with the detection distance, and automatically moves with the delay time. It can display the AVG curve of any aperture
AWS D1.1	choosing this standard can reduce manual calculations and improve detection efficiency
Weld diagram	support V type, T type, L type and other weld types, acoustic path navigation real-time display, weld and defect location real-time display, scaling, easy to locate defects
Automatic rating	select different AWS standards, automatically calculate the rating of defects and display
Crack height	the crack height is measured and calculated automatically by the diffracted wave at the end
Gate magnify	spreading of the gate range over the entire screen width
Continuous record	video recording and playback
Echo coding	display 1~9 echo display area in different colors, used to analyze the defect position
Scan freeze	display freeze holds waveform and test distance data
Peak mark	capture and mark the peak in real time
B scan	intuitively display the defect shape of the workpiece and the detection result is more intuitive

To be continued

Continued from previous page

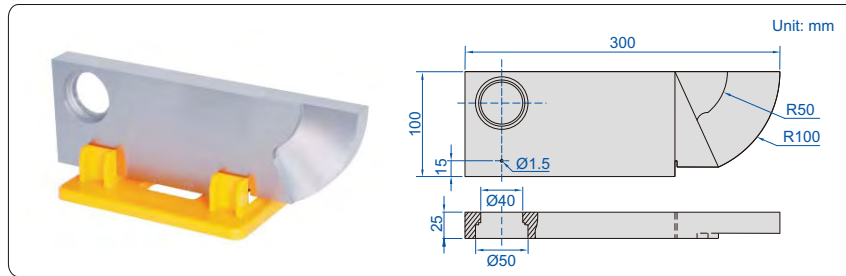

calibration block (optional)

SPECIFICATION

Measuring range	0~15000mm
Working frequency	0.2~20MHz
Material velocity	100~20000m/s
Repetition frequency	20~2000Hz
Dynamic range	≥36dB
Vertical linearity	≤1.5%
Horizontal linearity	≤0.1%
Resolving power	>42dB
Sensitivity leavings	>65dB
Suppression	0~80%
Noise	≤10%
Probe selection	single crystal probe, dual crystal probe, penetrating probe, climbing probe
Pulse energy	100V, 200V, 250V, 300V, 350V, 400V, 450V, 500V (selectable)
Pulse width	30ns-510ns
Probe damping	50Ω, 150Ω, 250Ω, 500Ω (selectable)
Rectification	positive half wave, negative half wave, full wave, RF
Gates	two independent gates controllable over entire sweep range
Interface	USB 2.0
Operation temperature	-10~50°C
Relative humidity	20~95%RH
Power	build-in rechargeable battery
Size	263×170×61mm
Weight	1.92kg

STANDARD DELIVERY

Main unit	1 pc
Single-element straight probe UFD-T60	1 pc
Single-element angle probe UFD-T61	1 pc
USB cable	1 pc
Couplant	1 bottle
Probe connecting cable	1 pc
USB disk	1 pc
Power adapter	1 pc

OPTIONAL ACCESSORY

Calibration block	UFD-CSK1
-------------------	----------

SPECIFICATION OF PROBE

Code	Frequency	Size	Probe type	Transducer sensor angle
UFD-T60 (included)	2.5MHz	Ø20mm	single-element straight probe	90°
UFD-T61 (included)	4.0MHz	8x9mm	single-element angle probe	60°
UFD-T62 (optional)	5.0MHz	Ø10mm	dual-element straight probe	90°
UFD-T63 (optional)	5.0MHz	Ø10mm	single-element straight probe	90°
UFD-T64 (optional)	4.0MHz	8x9mm	single-element angle probe	45°
UFD-T65 (optional)	4.0MHz	8x9mm	single-element angle probe	70°

Note: Other types of the probes are available

PORTABLE MAGNETIC POWDER FLAW DETECTORS



- Conformity to standards JB/T7411-2012 ASTM E1444-05 ASTM E709 EN10228-1;1999 ISO 9934 ASTM E3024
- Multiple power supply modes available



MPI-P110



DC battery pack 4400mAh
(optional)



AC battery pack 6600mAh
(optional)



A1 standard sensitivity test piece
(optional)



45N lifting force test block
(optional)



177N lifting force test block
(optional)



magnetic pole slope angle A
(optional)



magnetic pole slope angle B
(optional)



bag (optional)

SPECIFICATION

Code	MPI-P110	MPI-P220	MPI-P330
Magnetic field strength	>2KA/m		
Sensitivity	15/50 engraved groove clearly displayed on A1 standard sensitivity test piece		
Illumination	—	white light ≥ 2320 Lux	UV lamp $\geq 5220 \mu\text{W}/\text{cm}^2$
Duty cycle	>50% maximum excitation time 90 seconds		>30%
Lifting power	AC	≥ 4.5 kg (44N)	
	DC	≥ 18.1 kg (177N)	
Magnetic pole spacing	0-230mm		
Magnetic pole size	22×22mm		
Power supply	AC220V, 50Hz (DC battery pack or AC battery pack are optional)		
Operation temperature	-10~40°C		
Relative humidity	<80% (no condensation)		
Dimension (L×W×H)	235×50×195mm		
Weight	2.3kg		

STANDARD DELIVERY

Main unit	1 pc
-----------	------

OPTIONAL ACCESSORY

DC battery pack 4400mAh	MPI-PDC440
AC battery pack 6600mAh	MPI-PAC660
A1 standard sensitivity test piece	MPI-PA1
45N lifting force test block	MPI-P45N
177N lifting force test block	MPI-P177N
Magnetic pole slope angle A	MPI-PMA
Magnetic pole slope angle B	MPI-PMB
Bag	MPI-PBG



RECHARGEABLE UV FLAW DETECTION LIGHT CODE MPI-HF360

- UV-B content is 0
- Without preheating, instant start, instant on/off, no need to wait
- Supplied with glass filter
- External surface temperature increase <math><8K (8^{\circ}C)</math> for continuous working

goggles (included)



SPECIFICATION

UV (Light) Lux	about 6000 μ W/cm ²
UV light power	UV LED-12VA
Covering area	diameter approximately 300mm (calibrated at 381mm distance)
FLUX error	$\pm 10\%$ (at 0 $^{\circ}C$ ~40 $^{\circ}C$)
White light content	≤ 20 LUX
Lighting characteristics	center lighting
Wavelength	room temperature 25 $^{\circ}C$, 365nm \pm 3nm (UVA)
Power supply	12V rechargeable lithium battery
Battery capacity	3500mAh
Charging time	3~4h
Battery life	UV LED 5~6h
Dimension	175 \times 75 \times 170mm
Weight	750g (including battery)

STANDARD DELIVERY

Main unit	1 pc
Battery	2 pcs
Charger	1 pc
Goggles	1 pc

PENETRATION STANDARD TEST BLOCK CODE ISU-PB3

- Comply with ASME standard requirements
- The test block shows the number and clarity of lines of radiating cracks to determine the sensitivity level
- Suitable for verifying the sensitivity and operational accuracy of penetrants, as well as for testing the corrosion of stainless steel materials by penetrants



SPECIFICATION

Type	JB/T6064 B3 type
Surface treatment	chrome plating
Material	stainless steel

STANDARD DELIVERY

B3 test block	1 pc
B3 test block display image	1 pc

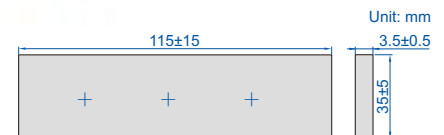

PENETRATION STANDARD TEST BLOCK CODE ISU-PB5

- Meets NB/47013.5 and ASME standards
- This test block is a means of verifying the sensitivity and operational accuracy of the penetrant, and has a rough surface in the sandblasting area to verify the cleaning performance of the penetrant and the accuracy of the cleaning method. Its sensitivity is determined by the number of defects displayed and the diameter of each point in the radial domain. It is a functional standard test block



Unit: mm

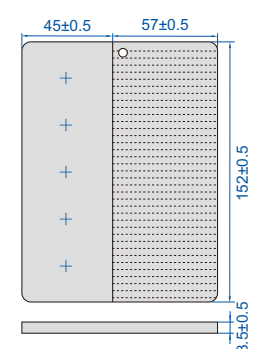

SPECIFICATION

Type	JB/T6064 B5 type
Surface treatment	chrome plating
Material	stainless steel

STANDARD DELIVERY

B5 test block	1 pc
B5 test block display image	1 pc





CMM
Page 475-478



Measuring Arms
Page 479-480



Styli For CMM
Page 481-482



CMM Check Masters
Page 482



Gage Block Stands For CMM
Page 483



Ceramic Ball Gages
Page 483

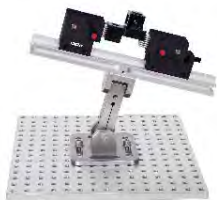

Jigs For CMM
Page 484-490

Can be used in shop floor, with the following features:

- Temperature compensation system, suitable for wide temperature range
- Water and oil resistance
- Compact design, small size
- Three sides open, easy to load and unload workpieces
- Without compress air
- Easy installation

ATTENTION: ROTATION OF PROBE HEAD IS MANUAL

ATTENTION: MEASUREMENT ON THE LEFT SIDE OF WORKPIECES IS LIMITED

MINI CNC CMM (SHOP FLOOR TYPE) CODE CMM-MN432



CMM-MN432

FEATURES

- Integrated control system, safe, reliable and easy to operate
- High precision linear guide rail and ball screw for three axes
- 4 temperature sensors for X, Y, Z three axes and workpiece, suitable for wide temperature range

CONTROL SYSTEM

- Double computer control systems
- Driven by DC servo motor
- The control system supports communication with machine tools
- The control system has 12 buttons for customize

NET-DMIS SOFTWARE

- Can measure point, straight line, curve, circle, ellipse, plane, groove, cylinder, sphere, cone, ring, edge point, corner point, polygon, straightness, flatness, circularity, cylindricity, profile of a line, profile of a surface, perpendicularity, parallelism, angularity, coaxiality, concentricity, symmetry, position, composite position, circular runout and total runout
- Modular software structure, can support: temperature compensation, turning table, I/O interface
- Can program in offline mode and do virtual measurement based on CAD model, can extract the element features of CAD for programming
- Support dynamic point measurement and import DMO theoretical point coordinates for vector point measurement
- Can import and convert CAD model (SAT, IGES, STEP)
- Can select multi language, metric and inch, polar and straight coordinate system
- Have multiple export ways: export measured data (SAT, IGES, STEP), report windows (PDF, HTML, MHT, RTF, EXCEL, CSV, txt, images, WORD, etc.), custom EXCEL template
- Support uploading the measuring result to server

To be continued

Continued from previous page

SPECIFICATION

Code	CMM-MN432
Measuring range (X×Y×Z)	400×200×300mm
Resolution	0.1µm
Repeatability	1µm
Accuracy (L is measuring range in mm)	±(4.5+L/200)µm (15°C~30°C, variation≤2°C/h) ±(5.5+L/200)µm (10°C~15°C, 30°C~40°C, variation≤2°C/h)
Probe error	±5µm
Temperature	10°C~40°C, variation≤2°C/h
Humidity	40~60%
Power	220V±10%, 50Hz
Max. load	50kg
Dimension (L×W×H)	1270×1110×1630mm
Weight	280kg

STANDARD DELIVERY

Main unit		1 pc
Probe system	probe head *	1 pc
	probe *	1 pc
	styli **	1 set
Calibration system	datum sphere (Ø25mm)	1 pc
	pivot pillar	1 pc
Computer system	computer	1 pc
	printer	1 pc
Temperature compensation system		1 pc
Software		1 pc

* The probe head and probe are Renishaw brand

** The styli system includes styli and extensions

PROBE (included) SPECIFICATION

Probe head	angular movement with horizontal axis	0°~90° in 15 steps
	angular movement with vertical axis	±180° in 15 steps
	control mode	manual
	number of positions	168
	probe mounting	M8
Probe	weight	210g
	detect direction	±X, ±Y, +Z
	styli mounting	M2
	rating life	>1000,000 times
	weight	22g

EXTENSION (included) SPECIFICATION

Code	Material	Stem diameter	Length	Quantity
SE4	stainless steel	Ø3mm	10mm	1 pc
SE5			20mm	1 pc

STYLUS (included) SPECIFICATION

Code	Material	Ball diameter	Length	Stem diameter	Effective working length	Quantity
PS2R	ruby ball / stainless steel stem	SØ2mm	20mm	Ø1.4mm	14mm	1 pc
PS17R		SØ4mm		Ø1.5mm	20mm	1 pc



COORDINATE MEASURING MACHINES

FEATURES

- X&Z axis beam are made of aviation aluminum
- RENISHAW steel scale
- High precision, rigid, pre-loaded air bearings on all axis

RENISHAW UCC CONTROL SYSTEM

- High speed measurement & servo control system

RATIONAL-DMIS SOFTWARE

- Unique operation interface, complete drag-and-drop operation
- Instructional programming allows users to replace text
- Intelligent recognition of the construction, calculation and output of relevant geometric elements
- Seamless link with CAD data

RENISHAW PROBE BODY

- The TP20 is a touch trigger probe
- The TP200B is a touch triggered probe of electronic strain sensing technology, with high measurement accuracy and operate life
- The SP25M is high performance scanning and touch trigger probe



CMM-ST564A

SPECIFICATION

Code	Range (X×Y×Z)	Probe body	MPEE	MPEP	Max. dimension of workpiece	Max. weight of workpiece	Overall dimension	Weight
	mm		µm	µm				
CMM-ST454A	400×500×400	TP20	±(2.1+3.3L/1000)	±2.2	525×995×600	500	1000×1240×2240	570
CMM-ST454B		TP200B	±(1.8+3.3L/1000)	±1.9				
CMM-ST454C		SP25M						
CMM-ST564A	500×600×400	TP20	±(2.1+3.3L/1000)	±2.2	625×1095×600	500	1100×1340×2240	700
CMM-ST564B		TP200B	±(1.8+3.3L/1000)	±1.9				
CMM-ST564C		SP25M						
CMM-ST686A	600×800×600	TP20	±(2.2+3.3L/1000)	±2.3	730×1400×800	700	1200×1650×2660	960
CMM-ST686B		TP200B	±(1.9+3.3L/1000)	±2.0				
CMM-ST686C		SP25M						
CMM-ST8106A	800×1000×600	TP20	±(2.2+3.3L/1000)	±2.3	930×1600×800	1000	1400×1850×2660	1270
CMM-ST8106B		TP200B	±(1.9+3.3L/1000)	±2.0				
CMM-ST8106C		SP25M						
CMM-ST10128A	1000×1200×800	TP20	±(2.7+3.3L/1000)	±2.7	1190×1814×1040	1800	1690×2370×3150	2460
CMM-ST10128B		TP200B	±(2.4+3.3L/1000)	±2.4				
CMM-ST10128C		SP25M						
CMM-ST10158A	1000×1500×800	TP20	±(2.7+3.3L/1000)	±2.7	1190×2114×1040	1800	1690×2670×3150	2820
CMM-ST10158B		TP200B	±(2.4+3.3L/1000)	±2.4				
CMM-ST10158C		SP25M						
CMM-ST10208A	1000×2000×800	TP20	±(2.7+3.3L/1000)	±2.7	1190×2614×1040	1800	1690×3270×3150	3410
CMM-ST10208B		TP200B	±(2.4+3.3L/1000)	±2.4				
CMM-ST10208C		SP25M						
CMM-ST121510A	1200×1500×1000	TP20	±(3.0+3.3L/1000)	±3.0	1390×2200×1200	2000	1890×2750×3330	3330
CMM-ST121510B		TP200B	±(2.7+3.3L/1000)	±2.7				
CMM-ST121510C		SP25M						
CMM-ST122010A	1200×2000×1000	TP20	±(3.0+3.3L/1000)	±3.0	1390×2700×1200	2000	1890×3350×3330	3910
CMM-ST122010B		TP200B	±(2.7+3.3L/1000)	±2.7				
CMM-ST122010C		SP25M						

To be continued

Continued from previous page

SPECIFICATION

Code	Range (X×Y×Z)	Probe body	MPEE	MPEP	Max. dimension of workpiece	Max. weight of workpiece	Overall dimension	Weight
	mm		µm	µm	mm	kg	mm	kg
CMM-ST152010A	1500×2000×1000	TP20	±(3.3+3.3L/1000)	±3.3	1690×2700×1200	3000	2190×3350×3370	5220
CMM-ST152010B		TP200B	±(3.0+3.3L/1000)	±3.0				
CMM-ST152010C		SP25M						
CMM-ST152510A	1500×2500×1000	TP20	±(3.3+3.3L/1000)	±3.3	1690×3200×1200	3000	2190×3850×3400	6680
CMM-ST152510B		TP200B	±(3.0+3.3L/1000)	±3.0				
CMM-ST152510C		SP25M						
CMM-ST153010A	1500×3000×1000	TP20	±(3.5+4L/1000)	±3.5	1690×3700×1200	3000	2260×3910×3420	8120
CMM-ST153010B		TP200B	±(3.2+4L/1000)	±3.2				
CMM-ST153010C		SP25M						
CMM-ST152512A	1500×2500×1200	TP20	±(3.5+4L/1000)	±3.5	1690×3200×1400	3000	2190×3850×3870	6730
CMM-ST152512B		TP200B	±(3.2+4L/1000)	±3.2				
CMM-ST152512C		SP25M						
CMM-ST152515A	1500×2500×1500	TP20	±(3.8+4L/1000)	±3.8	1680×3330×1700	3000	2190×3980×4500	6950
CMM-ST152515B		TP200B	±(3.5+4L/1000)	±3.5				
CMM-ST152515C		SP25M						
CMM-ST153015A	1500×3000×1500	TP20	±(4.0+4L/1000)	±4.0	1680×3830×1700	3000	2260×4040×4520	8440
CMM-ST153015B		TP200B	±(3.7+4L/1000)	±3.7				
CMM-ST153015C		SP25M						
CMM-ST163515A	1600×3500×1500	TP20	±(4.0+4L/1000)	±4.0	1780×4330×1700	3000	2360×4540×4520	9960
CMM-ST163515B		TP200B	±(3.7+4L/1000)	±3.7				
CMM-ST163515C		SP25M						
CMM-ST203015A	2000×3000×1500	TP20	±(4.5+4L/1000)	±4.5	2180×3930×1700	6000	2760×4240×4520	11200
CMM-ST203015B		TP200B	±(4.0+4L/1000)	±4.0				
CMM-ST203015C		SP25M						
CMM-ST203018A	2000×3000×1800	TP20	±(4.5+4L/1000)	±4.5	2180×3930×2000	6000	2760×4240×5120	11200
CMM-ST203018B		TP200B	±(4.0+4L/1000)	±4.0				
CMM-ST203018C		SP25M						

STANDARD DELIVERY

Main unit		1 pc
Probe system	probe head (Renishaw)	1 pc
	probe body (Renishaw)	1 pc
	styli (Renishaw)	1 set
Calibration sphere	Ø19mm	1 pc
Computer		1 pc
Printer		1 pc
Software		1 pc

OPERATION ENVIRONMENT

Air pressure	0.5~1.0MPa
Air supply	0.3~0.45m ³ /min
Temperature	20±2°C
Humidity	55%~65%
Power	220V±10%, 50/60Hz

STYLI INCLUDED IN SP25M

Material	Ball diameter	Length	Quantity
ruby ball/ stainless steel stem	SØ2mm	21mm	2 pcs
	SØ3mm	21mm	2 pcs
	SØ4mm	21mm	2 pcs
	SØ2mm	30mm	2 pcs
	SØ3mm	40mm	2 pcs
	SØ4mm	50mm	2 pcs
	SØ6mm	75mm	2 pcs
stainless steel stem	—	20mm	1 pc

PROBE HEAD SPECIFICATION

Probe head (PH10T)	angular movement with horizontal axis	0°~105° in 7.5 steps
	angular movement with vertical axis	±180° in 7.5 steps
	number of positions	720
	probe mounting	M8
	max. output torque	0.45N.m
Probe body	max. extension length	300mm
	weight	645g
	detect direction	±X, ±Y, ±Z
	styli mounting	M2
	rating life	>1000,000 times

STYLI INCLUDED IN TP20 AND TP200B

Material	Ball diameter	Length	Quantity
ruby ball/ stainless steel stem	SØ1mm	10mm	1 pc
	SØ2mm	20mm	1 pc
	SØ3mm	20mm	1 pc
	SØ3mm	30mm	1 pc
	SØ4mm	10mm	1 pc
	SØ4mm	30mm	1 pc
	SØ4mm	40mm	1 pc
	SØ5mm	20mm	1 pc
stainless steel stem	—	10mm	1 pc
	—	20mm	1 pc
	—	30mm	1 pc

MEASURING ARMS



- In accordance with ISO 10360-12
- Internal balance
- Dual high performance batteries
- Equivalent-arm design
- High-speed WiFi performance
- Aerospace grade carbon-fiber material
- Automatic power off
- U-shaped anti-collision design of the base



CMM-CM30

HIGH PRECISION, CM SERIES, 6-AXIS

(mm)

Code	Measuring range	Maximum permissible error				
		SPAT	E _{UNI}	P _{SIZE}	P _{FORM}	L _{DIA}
CMM-CM15	1500	0.018	0.025	0.009	0.016	0.026
CMM-CM20	2000	0.020	0.028	0.010	0.018	0.032
CMM-CM25	2500	0.023	0.030	0.012	0.022	0.038
CMM-CM30	3000	0.034	0.042	0.016	0.032	0.052
CMM-CM35	3500	0.043	0.056	0.020	0.038	0.066
CMM-CM40	4000	0.052	0.066	0.024	0.044	0.083
CMM-CM45	4500	0.061	0.089	0.038	0.078	0.108

HIGH PRECISION, CM SERIES, 7-AXIS

(mm)

Code	Measuring range	Maximum permissible error				
		SPAT	E _{UNI}	P _{SIZE}	P _{FORM}	L _{DIA}
CMM-CM20S	2000	0.022	0.030	0.012	0.022	0.040
CMM-CM25S	2500	0.027	0.032	0.013	0.025	0.048
CMM-CM30S	3000	0.042	0.053	0.020	0.035	0.078
CMM-CM35S	3500	0.055	0.066	0.024	0.043	0.092
CMM-CM40S	4000	0.065	0.082	0.029	0.048	0.102
CMM-CM45S	4500	0.073	0.099	0.043	0.082	0.132

STANDARD PRECISION, BE SERIES, 6-AXIS

(mm)

Code	Measuring range	Maximum permissible error				
		SPAT	E _{UNI}	P _{SIZE}	P _{FORM}	L _{DIA}
CMM-BE15	1500	0.028	0.036	0.015	0.029	0.038
CMM-BE20	2000	0.030	0.040	0.018	0.035	0.041
CMM-BE25	2500	0.035	0.045	0.020	0.038	0.050
CMM-BE30	3000	0.055	0.065	0.028	0.045	0.080
CMM-BE35	3500	0.075	0.080	0.035	0.058	0.098
CMM-BE40	4000	0.090	0.100	0.044	0.068	0.116
CMM-BE45	4500	0.112	0.120	0.048	0.086	0.128

To be continued

Continued from previous page



Single-point articulation test



Distance measurement error between two points



Sphere form measurement error



Sphere size measurement error



Sphere diameter obtained from performing the articulated location test (diameter of the spherical zone containing the centers of a sphere measured from multiple orientations)

SPECIFICATION

Temperature rate	3°C/5min
Battery life	5h for one battery; 10h for two batteries
Output	USB, WIFI
Operation Temperature	5°C~45°C
Operation humidity	0~95%, non-condensing
Power	100~240VAC, 50/60HZ
Weight	8.8kg~10.6kg



3mm zircon ball probe (included)



6mm zircon ball probe (included)



calibration cone (included)

STANDARD DELIVERY

Main unit	1 pc
3mm zircon ball probe	1 pc
6mm zircon ball probe	1 pc
Calibration cone	1 pc
Lithium batteries	2 pcs
USB cable	1 pc
Power adapter	1 pc
Dust cover	1 pc



magnetic base (optional)



electric vacuum base (optional)



DELL laptop (optional)

OPTIONAL ACCESSORY

DELL laptop	CMM-CEM-PC
Polyworks software	CMM-CEM-PW
Adjustable tripod	CMM-CEM-FAT
Electric vacuum base	CMM-CEM-EVCP
Magnetic base	CMM-CEM-IMM
Magnetic cones	CMM-CEM-MC
Magnetic spheres	CMM-CEM-MS
Point probe	CMM-CEM-PP
2mm ruby ball probe	CMM-CEM-RP2
5mm zircon ball probe	CMM-CEM-ZP5
10mm zircon ball probe	CMM-CEM-ZP10
3" straight probe extension	CMM-CEM-SPE3
4" straight probe extension	CMM-CEM-SPE4
60° probe adapter	CMM-CEM-DP60
90° probe adapter	CMM-CEM-DP90
3mm extended ball probe	CMM-CEM-EPB3
6mm extended ball probe	CMM-CEM-EPB6
Probe adapter	CMM-CEM-PA



adjustable tripod (optional)

STYLI FOR CMM

- Roundness: 0.25µm



ISQ-20-071



ISQ-25-125

M2 styli (mm)

Code	Ød	Ød1	L	L1*	Material of rod	Material of tip
ISQ-20-002	1	0.7	10	4.5	stainless steel	ruby
ISQ-20-006	2	1	10	6		
ISQ-20-010	3	1.5	10	10		
ISQ-20-021	2	1.4	20	14		
ISQ-20-025	3	1.5	20	17.5		
ISQ-20-027	4	2	20	20		
ISQ-20-052	0.5	0.3	10	3	carbide	ruby
ISQ-20-071	1	0.7	20	12.5		
ISQ-20-105	2	1.5	30	22.5	ceramic	
ISQ-20-120	3	2	30	27.5		
ISQ-20-201	4	3	50	50	carbon fibre	

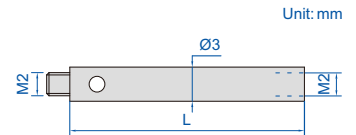

M2 extension rods of styli (mm)

Code	L	Material
ISQ-25-105	10	stainless steel
ISQ-25-110	20	
ISQ-25-125	30	ceramic

*L1 is the effective working length, which is the distance from the center of the tip to the section of the stem with the same diameter as the tip



ISQ-30-066

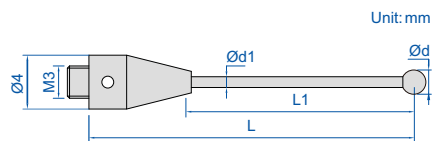

ISQ-35-110

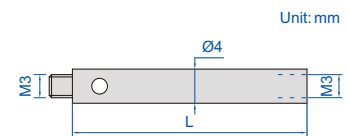

M3 styli (mm)

Code	Ød	Ød1	L	L1*	Material of rod	Material of tip
ISQ-30-001	1	0.7	21	4	carbide	ruby
ISQ-30-003	2	1.4	21	8		
ISQ-30-005	3	1.5	21	12		
ISQ-30-031	2	1.5	30	22.5		
ISQ-30-066	3	2	50	42.5	ceramic	ruby
ISQ-30-080	6	4	75	75	carbon fibre	

*L1 is the effective working length, which is the distance from the center of the tip to the section of the stem with the same diameter as the tip

M3 extension rods of styli (mm)

Code	L	Material
ISQ-35-101	10	stainless steel
ISQ-35-105	20	
ISQ-35-110	35	
ISQ-35-115	50	ceramic

To be continued

Continued from previous page



ISQ-40-195

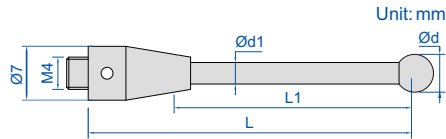

M4 styli (mm)

Code	Ød	Ød1	L	L1*	Material of rod	Material of tip
ISQ-40-113	3	2	18.5	13	stainless steel	ruby
ISQ-40-208	6	4	50	36		
ISQ-40-106	1	0.7	19.5	4	carbide	
ISQ-40-109	2	1.4	19	8		
ISQ-40-141	1	0.7	20	10		
ISQ-40-195	2	1.5	50	40		
ISQ-40-202	4	2	50	38		
ISQ-40-173	5	4	50	34	ceramic	
ISQ-40-179	6	4	50	36		
ISQ-40-222	6	4	75	63		
ISQ-40-240	5	4	100	84		
ISQ-40-245	6	4	100	86		

* L1 is the effective working length, which is the distance from the center of the tip to the section of the stem with the same diameter as the tip



ISQ-45-025

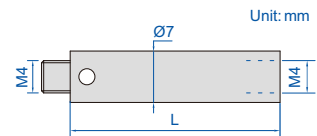

M4 extension rods of styli (mm)

Code	L	Material
ISQ-45-025	30	ceramic
ISQ-45-028	50	



ISQ-50-059

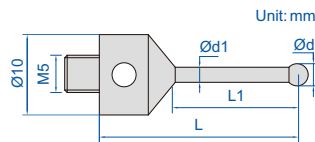

M5 styli (mm)

Code	Ød	Ød1	L	L1*	Material of rod	Material of tip
ISQ-50-051	1	0.7	20	5	carbide	ruby
ISQ-50-059	2	1.5	20	11		
ISQ-50-067	3	2	20	11		
ISQ-50-071	4	2	20	11		
ISQ-50-075	5	3	20	11		

* L1 is the effective working length, which is the distance from the center of the tip to the section of the stem with the same diameter as the tip

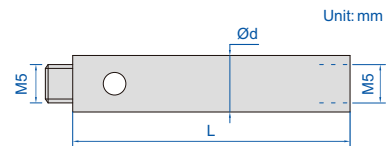

M5 extension rods of styli (mm)

Code	L	Ød	Material
ISQ-55-012	20	10	stainless steel
ISQ-55-014	30	10	
ISQ-55-016	50	10	
ISQ-55-018	100	10	
ISQ-55-031	50	20	aluminum
ISQ-55-035	100	20	
ISQ-55-039	200	20	

CMM CHECK MASTERS

REFER TO PAGE 294-295 FOR DETAILS



6882-600



6874-1000



GAGE BLOCK STAND FOR CMM

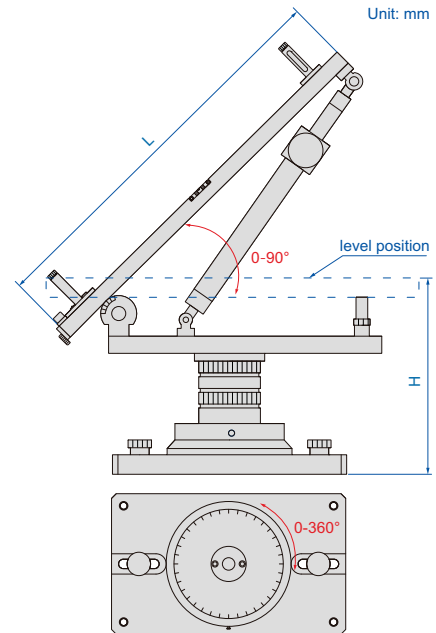

6885-1000

- Made of aluminum
- Used with gage blocks to calibrate CMM
- Optional accessory: gage blocks (4101 series)

Code	Length (L)	Height (H)
6885-1000	500, 600, 650, 700, 750, 800, 850, 900, 1000	235, 355, 475



height column (included, 2 pcs)



extension plate (included, 4 pcs)

- To calibrate CMM probes
- Zirconia material, high strength and hardness, extremely wear resistance and corrosion resistance good insulation, antistatic and magnetic resistance
- Mirror surface, with pole
- Supplied with manufacturer inspection certificate

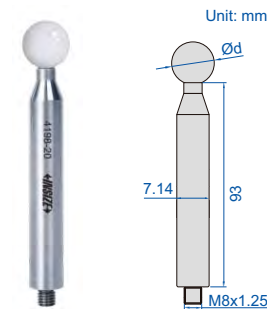

4198-20

CERAMIC BALL GAGES



High accuracy

Code	Diameter (Ød)	Accuracy	Roundness
4198-8	8mm	±5µm	0.5µm
4198-10	10mm	±5µm	0.5µm
4198-12D7	12.7mm	±5µm	0.5µm
4198-13	13mm	±5µm	0.5µm
4198-14	14mm	±5µm	0.5µm
4198-15	15mm	±5µm	0.5µm
4198-16	16mm	±5µm	0.5µm
4198-17	17mm	±5µm	0.5µm
4198-20	20mm	±5µm	0.5µm
4198-25D4	25.4mm	±5µm	0.5µm

Standard accuracy

Code	Diameter (Ød)	Accuracy	Roundness
4198-8A	8mm	±5µm	1µm
4198-10A	10mm	±5µm	1µm
4198-12D7A	12.7mm	±5µm	1µm
4198-13A	13mm	±5µm	1µm
4198-14A	14mm	±5µm	1µm
4198-15A	15mm	±5µm	1µm
4198-16A	16mm	±5µm	1µm
4198-17A	17mm	±5µm	1µm
4198-20A	20mm	±5µm	1µm
4198-25D4A	25.4mm	±5µm	1µm

JIGS FOR CMM (ANVIL Ø2.5mm)

CAN BE CUSTOMIZED

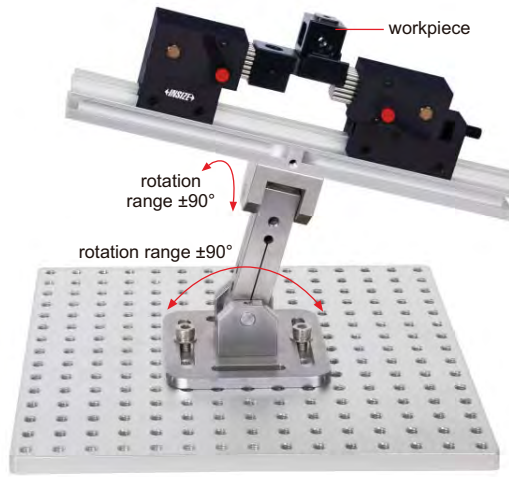

ISY-200



ISY-200-1



ISY-200-2



ISY-200-3



ISY-200-4



ISY-200-5



ISY-200-6

Code	Product	Remark
ISY-200	jig set	including 1 pc ISY-200-1, 1 pc ISY-200-2, 1 pc ISY-200-3, 1 pc ISY-200-4, 1 pc ISY-200-5 and 2 pcs ISY-200-6

Code	Product	Size	Anvil area	Anvil stroke
ISY-200-1	spring anvil	60×40×57	20.5×23	14
ISY-200-2	adjustable spring anvil (range 0-20mm)	70×40×57	20.5×23	14

Code	Product	Size
ISY-200-4	guide	300×40×27
ISY-200-5	two-way adjustable stand	110×110×142
ISY-200-6	clamp handle	—

Code	Product	Size	Hole size
ISY-200-3	base plate	300×300×12mm	M8



CAN BE
CUSTOMIZED

JIGS FOR CMM (ANVIL Ø6mm)

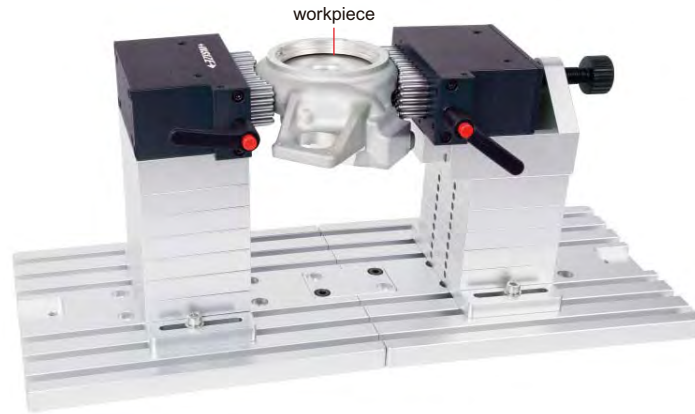

ISY-500



ISY-500-1



ISY-500-2



ISY-500-3



ISY-500-4



ISY-500-5



ISY-500-6



ISY-500-7

Code	Product	Remark
ISY-500	jig set	including 1 pc ISY-500-1, 1 pc ISY-500-2, 2 pcs ISY-500-3, 10 pcs ISY-500-4, 2 pcs ISY-500-5, 1 pc ISY-500-6, 2 pcs ISY-500-7

(mm)

Code	Product	Size	Anvil area	Anvil stroke
ISY-500-1	spring anvil	134×90×90	36×100	24
ISY-500-2	adjustable spring anvil (range 0-40mm)	134×120×130	36×100	24

(mm)

Code	Product	Size
ISY-500-3	base plate	300×240×20
ISY-500-4	block	120×90×20
ISY-500-5	connecting plate	170×90×15
ISY-500-6	connecting block of base plate	80×50×10
ISY-500-7	clamp handle	—

JIGS FOR CMM (ANVIL Ø2.5mm)

CAN BE CUSTOMIZED



ISY-300-1



ISY-300



ISY-300-2



ISY-300-3



ISY-300-4



ISY-300-5



ISY-300-6



ISY-300-7



ISY-300-8



ISY-300-9



ISY-300-10



ISY-300-11



ISY-300-12



ISY-300-13

Code	Product	Remark
ISY-300	jig set	including 1 pc ISY-300-1, 2 pcs ISY-300-2, 1 pc ISY-300-3, 2 pcs ISY-300-4, 14 pcs ISY-300-5, 2 pcs ISY-300-6, 8 pcs ISY-300-7, 6 pcs ISY-300-8, 2 pcs ISY-300-9, 2 pcs ISY-300-10, 2 pcs ISY-300-11, 2 pcs ISY-300-12, 2 pcs ISY-300-13

Code	Product	Size	Hole size
ISY-300-1	base plate	300×300×12mm	M8

Code	Product	Size	Anvil area	Anvil stroke
ISY-300-2	spring anvil	60×40×75	20.5×23	14
ISY-300-3	spring anvil	Ø26×80	3.1cm ² (hexagon)	14

Code	Product	Size (mm)
ISY-300-4	block	50×50×50
ISY-300-5	block	50×50×20
ISY-300-6	connecting plate	110×50×10
ISY-300-7	block	Ø26×20
ISY-300-8	block	Ø26×30
ISY-300-9	connecting plate	150×26×10
ISY-300-10	clip	65×11
ISY-300-11	clip	100×11
ISY-300-12	connecting block of clip stand	Ø26×20
ISY-300-13	clip stand	Ø8×75



CAN BE
CUSTOMIZED

JIGS FOR CMM (ANVIL Ø6mm)



ISY-400



ISY-400-1



ISY-400-2



ISY-400-3



ISY-400-4



ISY-400-5



ISY-400-6

Code	Product	Remark
ISY-400	jig set	including 3 pcs ISY-400-1, 9 pcs ISY-400-2, 9 pcs ISY-400-3, 1 pc ISY-400-4, 3 pcs ISY-400-5, 3 pcs ISY-400-6

(mm)

Code	Product	Size	Anvil area	Anvil stroke
ISY-400-1	spring anvil	135×60×90	36×100	24

(mm)

Code	Product	Size
ISY-400-2	block	120×60×20
ISY-400-3	block	120×60×30
ISY-400-4	base plate	500×500×12
ISY-400-5	connecting plate	130×120×12
ISY-400-6	clamp handle	—

JIG SET FOR CMM CODE ISY-100

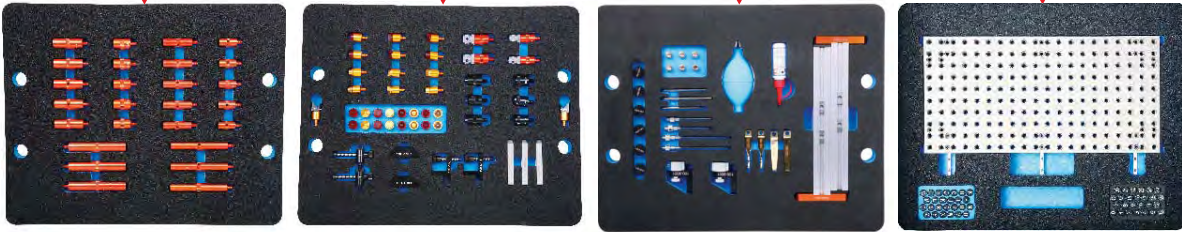

ISY-100

application examples

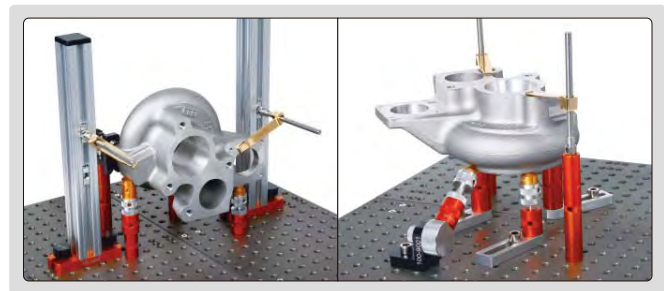

22

Product	Code	Size (mm)	Quantity	Application
	ISY-100-1001	Ø16×30	5	
	ISY-100-1002	Ø16×50	5	
	ISY-100-1003	Ø16×100	3	
	ISY-100-1004	Ø20×30	5	
	ISY-100-1005	Ø20×50	5	
	ISY-100-1006	Ø20×100	3	
stand with fine adjustment	ISY-100-2001	Ø16×45~60	2	height adjustment: 45~60mm
stand with fine adjustment	ISY-100-2003	Ø20×45~60	2	
horizontal spring stand	ISY-100-4001	—	2	

Product	Code	Size (mm)	Quantity	Application
horizontal screw stand	ISY-100-5001	—	2	
magnetic stand (magnetic top surface)	ISY-100-7001	Ø20×25	3	
stand for slice parts	ISY-100-8001	Ø20×25	2	ISY-100-8001 and ISY-100-8002 use cooperatively
clamping stand for slice parts	ISY-100-8002		1	

To be continued

Continued from previous page

Product	Code	Size (mm)	Quantity	Application
clip	ISY-100-1201	—	2	
clip	ISY-100-1301	—	2	
clip stand	ISY-100-1401	Ø6×60	2	
clip stand	ISY-100-1402	Ø6×100	2	
vertical square column	ISY-100-3003	30×30×250	2	
sliding support plate	ISY-100-1801	78×20×10	3	
clamping screw	ISY-100-2301	Ø8×20	6	
screw	ISY-100-2302	Ø8×20	6	
base plate	ISY-600-400200	400×400×12 hole size: M8×1.25 hole center distance: 20	2 pieces	—
wrench	ISY-100-3701	Ø3.8×70	1	—
wrench	ISY-100-3801	M2.5	1	—
wrench	ISY-100-3802	M5	1	—
wrench	ISY-100-3803	M6	1	—
45° stand	ISY-100-9001	—	2	
V shaped support	ISY-100-1901	—	2	

Product	Code	Quantity	Application
V shaped support	ISY-100-1902	2	
marker	ISY-6100-1501	52*	
dust cleaner	ISY-100-3501	1	—
lubricating oil	ISY-100-3601	1	—

* Letter A~Z, number 0~25

Product	Code	Quantity	Material	Application
support head	ISY-100-27016	2	aluminum	
	ISY-100-27018	2	nylon	
support head	ISY-100-27026	2	aluminum	
	ISY-100-27028	2	nylon	
support head	ISY-100-27036	2	aluminum	
	ISY-100-27038	2	nylon	
support head	ISY-100-27046	2	aluminum	
	ISY-100-27048	2	nylon	
support head	ISY-100-27056	2	aluminum	
	ISY-100-27058	2	nylon	
support head	ISY-100-27066	2	aluminum	
	ISY-100-27068	2	nylon	
support head	ISY-100-27076	2	aluminum	
	ISY-100-27078	2	nylon	

JIG SET FOR CMM CODE ISY-600



application example



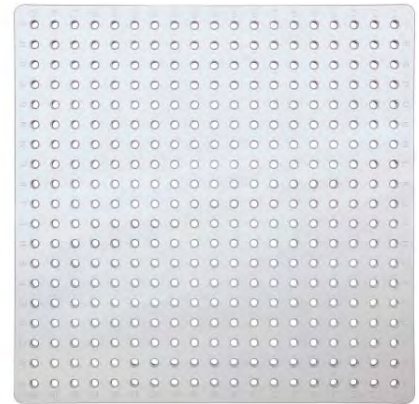

acrylic tray (included)



ISY-600

Product	Code	Size (mm)	Quantity
stand 	ISY-600-80001	Ø12×50	6
	ISY-600-80002	Ø12×30	6
	ISY-600-80007	Ø12×20	6
stand 	ISY-600-80003	Ø16×50	6
	ISY-600-80004	Ø16×30	6
	ISY-600-80008	Ø16×20	6
stand 	ISY-600-80005	Ø20×50	6
	ISY-600-80006	Ø20×30	6
	ISY-600-80009	Ø20×20	6
spring stand 	ISY-600-800010	—	2
universal support with damping 	ISY-600-800012	—	2
stand with fine adjustment 	ISY-600-800013	Ø20×55~78	2
magnetic stand (magnetic top surface) 	ISY-600-800014	Ø20×20	4
stand for slice parts 	ISY-600-800015	Ø20×20	2
adaptor 	ISY-600-800016	Ø20×15	6
clamping screw for base plate 	ISY-600-800017	—	2

Product	Code	Size (mm)	Quantity
V shaped support 	ISY-600-800018	Ø20×25	2
clamping screw 	ISY-600-800019	—	6
sliding support plate 	ISY-600-800020	68×20×10	6
clip 	ISY-600-800021	12×70	5
chuck support 	ISY-600-800022	—	2
clip stand 	ISY-600-800023	Ø6×80	2
	ISY-600-800024	Ø6×40	3
aluminum support head 	ISY-600-800025	—	3
nylon support head 	ISY-600-800026	—	3
wrench 	ISY-600-800027	Ø8×48	2
base plate 	ISY-600-800028	400×400×15 hole size: M8X1.25	1



Tool Presetters
Page 492-494



Profile Projectors
Page 495-504



Quick Measurement Systems
Page 505-510



Vision Measuring Systems
Page 511-520

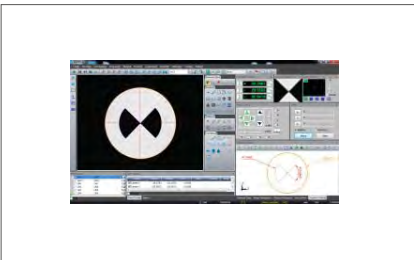

Vision Measuring Softwares
Page 521-522

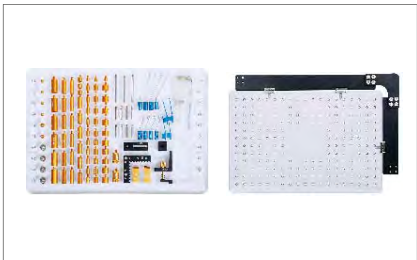

**Jig Sets For Vision Measuring
Systems**
Page 523



Standard Glass Scales
Page 524

TOOL PRESETTER (PROJECTOR TYPE) CODE TLP-P340



projection screen Ø120mm with scale
(protractor with 1° graduation, radius with 0.2,
0.4, 0.8, 1.2, 1.5, 2, 2.5, 3mm graduation)

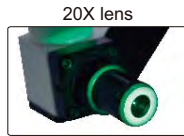
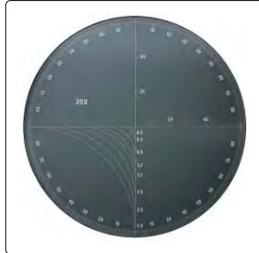

■ 99 data can be saved and printed



standard rod (included)



BT50/BT40 converter (optional)



BT50/BT30 converter (optional)

SPECIFICATION

Maximum tool diameter (X axis)		Ø300mm
Height measuring range (Z axis)		30~400mm
Accuracy	X axis	±6µm
	Z axis	±13µm
Resolution		0.5µm
Diameter of projection screen		Ø120mm
Lens	magnification	20X
	view filed	Ø6mm
Illumination		24V/20W
Spindle holder		BT50
Power supply		220V, 50/60HZ
Dimension (L×W×H)		940×520×870mm
Weight		90kg

STANDARD DELIVERY

Main unit	1 pc
BT50 spindle holder	1 pc
Standard rod	1 pc
Foot-switch	1 pc
Anti-dust cover	1 pc

OPTIONAL ACCESSORY

BT50/BT30 converter	TLP-P340-C1
BT30 rod	TLP-P340-R1
BT50/BT40 converter	TLP-P340-C2
BT40 rod	TLP-P340-R2

TOOL PRESETTER CODE TLP-400E



rotate the handwheel to rotate tools



standard rod (included)



BT50/BT40 converter (optional)



BT50/BT30 converter (optional)

- Absolute linear scales, zero setting is not needed after power on and off

SPECIFICATION

Maximum tool diameter (X axis)	Ø300mm
Height measuring range	60~400mm
Repeatability	0.005mm
Measuring accuracy	0.01mm
Linear scale resolution	0.001mm
Dial indicator graduation	0.001mm
Spindle holder	BT50
Power supply	110/220V, 50/60HZ
Dimension (L×W×H)	720x480x930mm
Weight	150kg

STANDARD DELIVERY

Main unit	1 pc
BT50 spindle holder	1 pc
Standard rod	1 pc
Dial indicator	2 pcs
Wrench	1 set
Anti-dust cover	1 pc

OPTIONAL ACCESSORY

BT50/BT30 converter	TLP-300H-C1
BT50/BT40 converter	TLP-300H-C2

TOOL PRESETTER (BASIC TYPE) CODE TLP-300H



standard rod (included)



BT50/BT40 converter (optional)



BT50/BT30 converter (optional)

- Absolute linear scales, zero setting is not needed after power on and off

SPECIFICATION

Maximum tool diameter (X axis)	Ø300mm
Height measuring range	60~300mm
Repeatability	0.005mm
Measuring accuracy	0.02mm
Linear scale resolution	0.005mm
Dial indicator graduation	0.01mm
Spindle holder	BT50
Power supply	110/220V, 50/60HZ
Dimension (L×W×H)	600x365x690mm
Weight	68kg

STANDARD DELIVERY

Main unit	1 pc
BT50 spindle holder	1 pc
Standard rod	1 pc
Dial indicator	2 pcs
Wrench	1 set
Anti-dust cover	1 pc

OPTIONAL ACCESSORY

BT50/BT30 converter	TLP-300H-C1
BT50/BT40 converter	TLP-300H-C2



ISP-Z3015



ISP-A1000E

digital readout of ISP-A1000E



- touch buttons
- USB data output to Excel and CAD
- show diagram



software flash disk (included, only for ISP-A1000E)

OPTIONAL ACCESSORY



lens

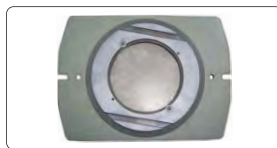

rotary table (glass plate diameter 100mm)



overlay chart (protractor with 1° graduation, radius with 1mm increment)



holder with clamp



swivel center support



V-block with clamp



50mm reading scale (check magnification accuracy)



300mm calibration scale (check magnification accuracy together with 50mm reading scale or calibrate measuring accuracy)

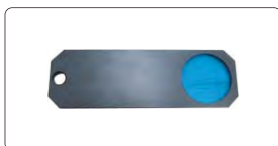

blue filter



demo sample



printer (only for ISP-A1000E)

To be continued

Continued from previous page

SPECIFICATION

Code		ISP-Z3015	ISP-A1000E		
Edge detector		not included	included		
Lens	magnification	10X (included)	20X (optional)	50X (optional)	100X (optional)
	view field	Ø30mm	Ø15mm	Ø6mm	Ø3mm
	working distance	77.7mm	44.3mm	38.4mm	25.3mm
Max. workpiece height		90mm	90mm	90mm	90mm
Magnification accuracy		±0.08%			
Image		erect image			
Projector screen		diameter: Ø300mm			
		rotation range: 0°~360°, resolution: 1" or 0.01°			
		reference lines: cross-hairs			
Stage	metal stage size	340×152mm			
	glass stage size	196×96mm			
	X-Y stage travel	range: 150×50mm			
		resolution: 0.5µm			
	Z (focus) travel range	90mm			
max. load capacity	4kg				
Illumination		contour illumination: 24V/150W halogen lamp, brightness is adjustable			
		surface illumination: 24V/150W halogen lamp			
Data processing unit	display	X-Y stage travel, screen rotation			
	output	RS232C		RS232C, USB (data output to Excel and CAD)	
	function	measure coordinate of point	measure coordinate of point		
		measure coordinate of line	measure coordinate of line		
measure center coordinate, radius of circle with three points		measure center coordinate, radius of circle with three points			
measure distance between two objects		measure distance between two objects			
measure angle with four points or two lines		measure angle with four points or two lines			
set origin of coordinate		coordinate transform			
coordinate transform		choose measurement object automatically according to the selective point and display the result			
set midpoint of coordinate					
advanced function	—		programming for batch measurements		
Power supply		110/220V, 50/60Hz			
Dimension (L×W×H)		550×770×1100mm			
Weight		135kg			

23

STANDARD DELIVERY

Main unit	1 pc
10X lens with half-reflection mirror and oblique illuminator mirror	1 pc
Overlay chart clip	4 pcs
Foot-switch	1 pc
Anti-dust cover	1 pc
Software (only for ISP-A1000E) and USB cable	1 pc

OPTIONAL ACCESSORY

20X lens with half-reflection mirror and oblique illuminator mirror	ISP-Z3015-LENS20X
50X lens with half-reflection mirror	ISP-Z3015-LENS50X
100X lens with half-reflection mirror	ISP-Z3015-LENS100X
Rotary table	ISP-Z3015-TABLE
Overlay chart	ISP-Z3015-CHART
Holder with clamp	ISP-Z3015-HOLDER

Swivel center support	ISP-Z3015-SUPPORT
V-block with clamp	ISP-Z3015-VBLOCK
50mm reading scale	ISP-Z3015-SCALE50
300mm calibration scale	ISP-Z3015-RULE
Blue filter	ISP-Z3015-FILTER
Demo sample	ISP-Z3015-DEMO
Printer (only for ISP-A1000E)	ISP-A1000-PRINTER

THE STAGE DOESN'T
MOVE UP AND DOWN

**INSPECTION
CERTIFICATE**

PROFILE PROJECTORS



ISP-AZ3020



ISP-A5000E



digital readout of ISP-A5000E

- Adjust the focus by ascending and descending the projector head, the stage doesn't move up and down
- Maximum workpiece weight 50kg

- touch buttons
- USB data output to Excel and CAD
- show diagram



software flash disk
(included, only for
ISP-A5000E)

OPTIONAL ACCESSORY



lens

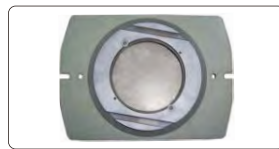

rotary table
(glass plate diameter 100mm)



overlay chart (protractor with 1°
graduation, radius with 1mm increment)



holder with clamp



swivel center support



V-block with clamp



50mm reading scale
(check magnification accuracy)



300mm calibration scale (check
magnification accuracy together
with 50mm reading scale or
calibrate measuring accuracy)



demo sample



printer (only for ISP-A5000E)

To be continued

Continued from previous page

SPECIFICATION

Code		ISP-AZ3020	ISP-A5000E	
Edge detector		not included	included	
Lens	magnification	10X (included) 20X (optional)	50X (optional) 100X (optional)	
	view field	Ø30mm	Ø6mm	
	working distance	77.7mm	25.3mm	
Max. workpiece height		100mm	100mm	
Magnification accuracy		±0.08%		
Image		erect image		
Projector screen		diameter: Ø300mm		
		rotation range: 0°~360°, resolution: 1" or 0.01°		
		reference lines: cross-hairs		
Stage	metal stage size	404×228mm		
	glass stage size	260×160mm		
	X-Y stage travel	range: 200×100mm		
		resolution: 0.5µm		
	Z (focus) travel range	100mm		
max. load capacity	50kg			
Illumination		contour illumination: 24V/150W halogen lamp, brightness is adjustable		
		surface illumination: 24V/150W halogen lamp		
Data processing unit	display	X-Y stage travel, screen rotation		
	output	RS232C	RS232C, USB (data output to Excel and CAD)	
	function	measure coordinate of point		measure coordinate of point
		measure coordinate of line		measure coordinate of line
measure center coordinate, radius of circle with three points			measure center coordinate, radius of circle with three points	
measure distance between two objects			measure distance between two objects	
measure angle with four points or two lines			measure angle with four points or two lines	
set origin of coordinate			coordinate transform	
coordinate transform			choose measurement object automatically according to the selective point and display the result	
set midpoint of coordinate				
advanced function	—	programming for batch measurements		
Power supply		110/220V, 50/60Hz		
Dimension (L×W×H)		780×780×1100mm		
Weight		160kg		

23

STANDARD DELIVERY

Main unit	1 pc
10X lens with half-reflection mirror and oblique illuminator mirror	1 pc
Overlay chart clip	4 pcs
Foot-switch	1 pc
Blue filter	1 pc
Anti-dust cover	1 pc
Software (only for ISP-A5000E) and USB cable	1 pc

OPTIONAL ACCESSORY

20X lens with half-reflection mirror and oblique illuminator mirror	ISP-A5000-LENS20X
50X lens with half-reflection mirror	ISP-A5000-LENS50X
100X lens with half-reflection mirror	ISP-A5000-LENS100X
Rotary table	ISP-A5000-TABLE
Overlay chart	ISP-A5000-CHART
Holder with clamp	ISP-A5000-HOLDER
Swivel center support	ISP-A5000-SUPPORT
V-block with clamp	ISP-A5000-VBLOCK
50mm reading scale	ISP-A5000-SCALE50
300mm calibration scale	ISP-A5000-RULE
Demo sample	ISP-A5000-DEMO
Printer (only for ISP-A5000E)	ISP-A5000-PRINTER

HORIZONTAL PROFILE PROJECTORS



ISP-W3020



ISP-A3000E

digital readout of ISP-A3000E



VIDEO

- touch buttons
- USB data output to Excel and CAD
- show diagram



software flash disk
(included, only for
ISP-A3000E)

OPTIONAL ACCESSORY



lens



overlay chart (protractor with 1°
graduation, radius with 1mm increment)



50mm reading scale
(check magnification accuracy)



demo sample



vise



rotary table



300mm calibration scale (check
magnification accuracy together
with 50mm reading scale or
calibrate measuring accuracy)



printer (only for ISP-A3000E)

To be continued

Continued from previous page

SPECIFICATION

Code		ISP-W3020		ISP-A3000E	
Edge detector		not included		included	
Lens	magnification	10X (included)	20X (optional)	50X (optional)	100X (optional)
	view field	Ø30mm	Ø15mm	Ø6mm	Ø3mm
	working distance	77.7mm	44.3mm	38.4mm	25.3mm
Magnification accuracy		±0.08%			
Projector screen		diameter: Ø300mm rotation range: 0°~360°, resolution: 1' or 0.01° reference lines: cross-hairs			
Stage	metal stage size	400×150mm			
	turning range	±15°			
	X-Z stage travel	range: 200×100mm			
		resolution: 0.5µm			
	Y (focus) travel range	accuracy: (4+L/25)µm L is the measuring length in mm			
max. load capacity	75mm				
Illumination		contour illumination: 24V/150W halogen lamp, brightness is adjustable surface illumination: 12V/150W halogen lamp (with 2 fibers), position is adjustable			
Data processing unit	display	X-Z stage travel, screen rotation			
	output	RS232C		RS232C, USB (data output to Excel and CAD)	
	function	measure coordinate of point measure coordinate of line measure center coordinate, radius of circle with three points measure distance between two objects measure angle with four points or two lines set origin of coordinate coordinate transform set midpoint of coordinate		measure coordinate of point measure coordinate of line measure center coordinate, radius of circle with three points measure distance between two objects measure angle with four points or two lines coordinate transform choose measurement object automatically according to the selective point and display the result	
advanced function	—		programming for batch measurements		
Power supply		110/220V, 50/60Hz			
Dimension (L×W×H)		830×1090×1010mm			
Weight		160kg			

23

STANDARD DELIVERY

Main unit	1 pc
10X lens	1 pc
Overlay chart clip	4 pcs
Foot-switch	1 pc
Anti-dust cover	1 pc
Software (only for ISP-A3000E) and USB cable	1 pc

OPTIONAL ACCESSORY

20X lens	ISP-A3000-LENS20X
50X lens	ISP-A3000-LENS50X
100X lens	ISP-A3000-LENS100X
Overlay chart	ISP-A3000-CHART
50mm reading scale	ISP-A3000-SCALE50
300mm calibration scale	ISP-A3000-RULE

Demo sample	ISP-A3000-DEMO
V-block with clamp	ISP-A3000-VBLOCK
Rotary table	ISP-A3000-RTABLE
Vise	ISP-A3000-UISE
Printer (only for ISP-A3000E)	ISP-A3000-PRINTER

HORIZONTAL PROFILE PROJECTORS



ISP-W4025



ISP-A7000E

digital readout of **ISP-A7000E**



- touch buttons
- USB data output to Excel and CAD
- show diagram



software flash disk (included, only for **ISP-A7000E**)

OPTIONAL ACCESSORY



lens



vise



rotary table



demo sample (need rotary table)



printer (only for **ISP-A7000E**)



50mm reading scale (check magnification accuracy)



300mm calibration scale (check magnification accuracy together with 50mm reading scale or calibrate measuring accuracy)



Ø300mm overlay chart (protractor with 1° graduation, radius with 1mm increment)

To be continued

Continued from previous page

SPECIFICATION

Code		ISP-W4025			ISP-A7000E		
Edge detector		not included			included		
Lens	magnification	5X (optional)	10X (standard)	20X (optional)	50X (optional)	100X (optional)	
	view field	Ø80mm	Ø40mm	Ø20mm	Ø8mm	Ø4mm	
	working distance	93.7mm	103.9mm	95.1mm	65.7mm	35mm	
Magnification accuracy		±0.08%					
Image		erect image					
Projector screen		diameter: Ø400mm					
		rotation range: 0°~360°, resolution: 1' or 0.01°					
		reference lines: cross-hairs					
Stage	metal stage size	450×200mm					
	turning range	±15°					
	X-Z stage travel	range: 250×150mm					
		resolution: 0.5µm					
	Y (focus) travel range	accuracy: (4+L/25)µm L is the measuring length in mm					
max. load capacity	100mm						
Illumination		contour illumination: 24V/150W halogen lamp, brightness is adjustable					
		surface illumination: 12V/150W halogen lamp (with 2 fibers), position is adjustable					
Data processing unit	display	X-Z stage travel, screen rotation					
	output	RS232C			RS232C, USB (data output to Excel and CAD)		
	function	measure coordinate of point	measure coordinate of point			measure coordinate of point	
		measure coordinate of line	measure coordinate of line			measure coordinate of line	
		measure center coordinate, radius of circle with three points	measure center coordinate, radius of circle with three points			measure center coordinate, radius of circle with three points	
		measure distance between two objects	measure distance between two objects			measure distance between two objects	
		measure angle with four points or two lines	measure angle with four points or two lines			measure angle with four points or two lines	
		set origin of coordinate	set origin of coordinate			coordinate transform	
		coordinate transform	coordinate transform			choose measurement object automatically according to the selective point and display the result	
		set midpoint of coordinate	set midpoint of coordinate				
advanced function	—			programming for batch measurements			
Power supply		110/220V, 50/60Hz					
Dimension (L×W×H)		646×1215×1210mm					
Weight		240kg					

23

STANDARD DELIVERY

Main unit	1 pc
10X lens	1 pc
Overlay chart clip	4 pcs
Foot-switch	1 pc
Anti-dust cover	1 pc
Software (only for ISP-A7000E) and USB cable	1 pc

OPTIONAL ACCESSORY

5X lens	ISP-W4025-LENS5X
20X lens	ISP-W4025-LENS20X
50X lens	ISP-W4025-LENS50X
100X lens	ISP-W4025-LENS100X
Ø300mm overlay chart	ISP-A3000-CHART
50mm reading scale	ISP-A3000-SCALE50

300mm calibration scale	ISP-A3000-RULE
Demo sample	ISP-A3000-DEMO
V-block with clamp	ISP-A3000-VBLOCK
Rotary table	ISP-A3000-RTABLE
Vise	ISP-A3000-VISE
Printer (only for ISP-A7000E)	ISP-A3000-PRINTER

PROFILE PROJECTORS

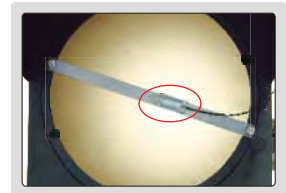

edge detector (for ISP-A6000E)

digital readout

- touch buttons
- USB data output to Excel and CAD
- show diagram

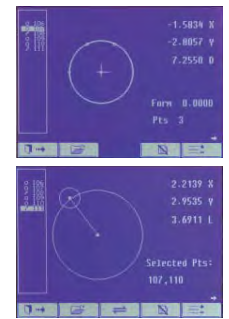

software flash disk (included)

ISP-A6000 (without edge detector)

OPTIONAL ACCESSORY



lens



rotary table (glass plate diameter 100mm)



holder with clamp



printer



300mm calibration scale (check magnification accuracy together with 50mm reading scale or calibrate measuring accuracy)



50mm reading scale (check magnification accuracy)



demo sample

To be continued

Continued from previous page

SPECIFICATION

Code		ISP-A6000	ISP-A6000E			
Edge detector		not included	included			
Projector screen		diameter: Ø600mm				
		rotation range: 0°~360°, resolution: 1' or 0.01°				
		reference lines: cross-hairs				
Lens	magnification	5X (optional)	10X (included)	20X (optional)	50X (optional)	100X (optional)
	view field	Ø120mm	Ø60mm	Ø30mm	Ø12mm	Ø6mm
	working distance	242.8mm	143.2mm	85.5mm	92mm	48.5mm
Magnification accuracy		±0.08%				
Image		erect image				
Stage	metal stage size	404×265mm				
	glass stage size	207×170mm				
	X-Y stage travel	range: 200×100mm				
		resolution: 0.5µm				
	Z (focus) travel range	50mm				
max. load capacity	5kg					
Illumination		contour illumination: 24V/150W halogen lamp, brightness is adjustable				
		surface illumination: 12V/150W halogen lamp (with 2 fibers), position is adjustable				
Data processing unit	display	X-Y stage travel, screen rotation				
	output	RS232C, USB (data output to Excel and CAD)				
	function	measure coordinate of point				
		measure coordinate of line				
measure center coordinate, radius of circle with three points						
measure distance between two objects						
measure angle with four points or two lines						
coordinate transform						
choose measurement object automatically according to the selective point and display the result						
advanced function	programming for batch measurements					
Power supply		110/220V, 50/60Hz				
Dimension (L×W×H)		1200×1140×1940mm				
Weight		360kg				

23

STANDARD DELIVERY

Main unit	1 pc
10X lens	1 pc
Foot-switch	1 pc
Software and USB cable	1 pc
Overlay chart clip	4 pcs
Anti-dust cover	1 pc

OPTIONAL ACCESSORY

5X lens	ISP-A6000-LENS5X
20X lens	ISP-A6000-LENS20X
50X lens	ISP-A6000-LENS50X
100X lens	ISP-A6000-LENS100X
Holder with clamp	ISP-A6000-HOLDER

300mm calibration scale	ISP-A6000-RULE
50mm reading scale	ISP-A6000-SCALE50
Rotary table	ISP-A6000-TABLE
Demo sample	ISP-A6000-DEMO
Printer	ISP-A6000-PRINTER



LARGE SIZE QUICK MEASUREMENT SYSTEM CODE QMS-A450



SPECIFICATION

Optical lens		dual-field dual-telecentric low-distortion lens	
Measurement range		wide view field	small view field
		500×400mm	430×350mm
Measurement Accuracy	without stitching	±3μm ^①	±1μm ^②
	with stitching	±(5+0.02L)μm ^③	±(3+0.02L)μm ^④
Repeatability	without stitching	±1μm	±0.5μm
	with stitching	±2μm	±1.5μm
Illumination system	transmission light	telecentric illuminator, green light	
	surface light	vertical illuminator, high angle ring white light vertical illuminator, 4-zone low and medium angle ring white light (electric) vertical illuminator, circular (directional) green light (electric)	
	coaxial light (optional)	vertical illuminator, white light	
Max. weight of workpiece		25kg	
Measurement time		<2s	
Measurement data		2D measurement	
Environmental requirement		temperature: 20°C±2°C, relative humidity: 30%~80%, vibration: <0.002g, less than 15Hz	
Power supply		220V, 50Hz, 1200W	
Dimension (L×W×H)		1060×860×1890mm	
Weight		650kg	

* The optimum temperature is 20°C±1°C

- ① Within 73×49mm, on focal position and environment temperature at 20°C±1°C
- ② Within 16×12mm, on focal position and environment temperature at 20°C±1°C
- ③ Within 450×360mm, on focal position and environment temperature at 20°C±1°C
- ④ Within 387×315mm, on focal position and environment temperature at 20°C±1°C

Continued from previous page

- One or more workpieces can be measured by one step operation
- Place workpieces at any position
- Focus and measure automatically
- Measurement of 999+dimensions and 200+workpieces
- Suitable for parts with high precision requirements for large, medium, and small sizes

STANDARD DELIVERY

Main unit	1 pc
Computer	1 pc
Software	1 pc

OPTIONAL ACCESSORY

Coaxial light illumination	QMS-43-A1
Data transmission function of software	QMS-23-D1
CAD import function of software	QMS-23-C1
Laser sensor	QMS-43-SJ1
Foot-switch	QMS-43-FS1

Software (included)

- Automatically measure widths, holes, rings, angles at the same time, simple and efficient

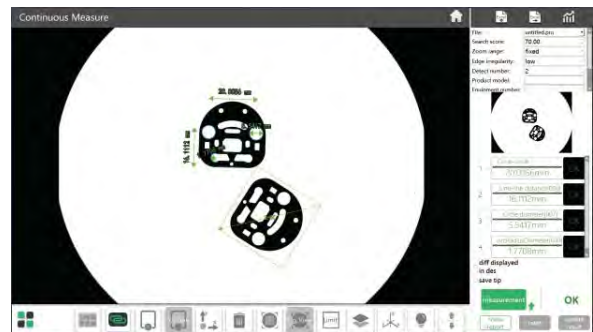

- Measuring result can be stored automatically. OK items and NG items can be counted automatically



NOTE: NOT SUITABLE FOR SMALL SIZES SUCH AS THREADS, CHAMFERS, ETC

QUICK MEASUREMENT SYSTEMS (WITH STITCHING)

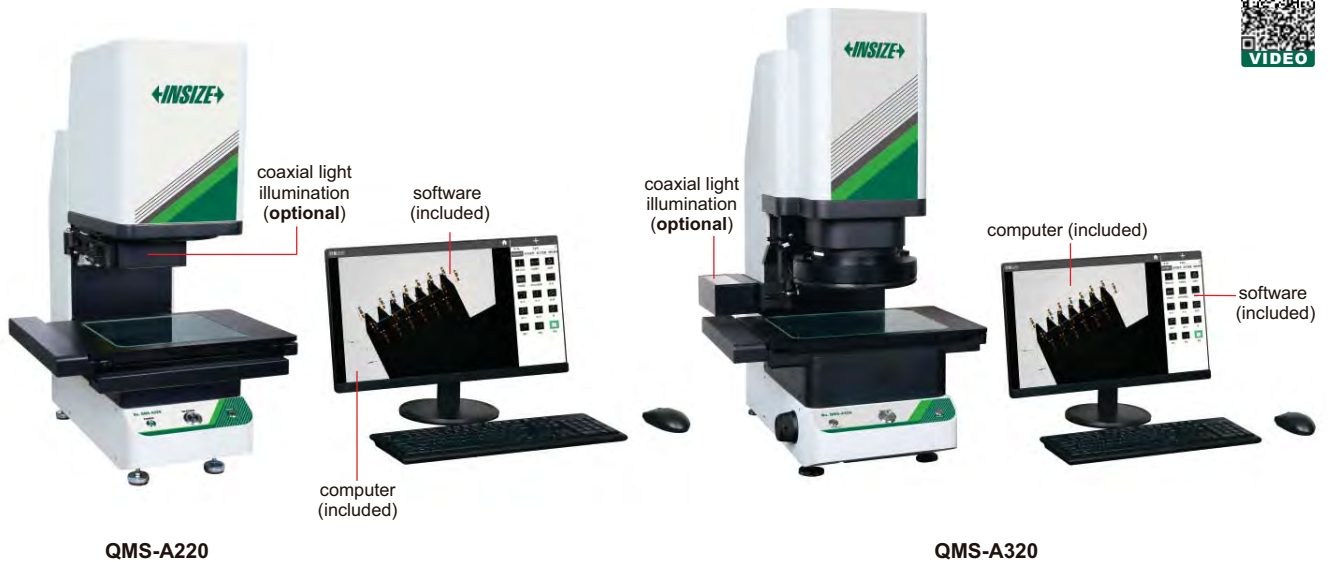

QMS-A220

QMS-A320

SPECIFICATION

Code		QMS-A220	QMS-A315	QMS-A320	
Optical lens		dual-field dual-telecentric low-distortion lens			
		wide view field: Ø100mm small view field: Ø25mm	wide view field: Ø100mm small view field: Ø25mm	wide view field: Ø150mm small view field: Ø50mm	
View field range		wide view field	small view field	wide view field	small view field
		93×62mm	20×16mm	100×80mm	25×20mm
Measurement range		200×200mm	130×130mm	300×200mm	230×130mm
Measurement accuracy *	without stitching	±3µm ^①	±1µm ^②	±3µm ^①	±1µm ^②
	with stitching	±(5+0.02L)µm ^⑤	±(3+0.02L)µm ^⑥	±(5+0.02L)µm ^⑦	±(3+0.02L)µm ^⑧
Repeatability	without stitching	±1µm	±0.5µm	±1µm	±0.5µm
	with stitching	±2µm	±1.5µm	±2µm	±1.5µm
Max. weight of workpiece		5kg			
Measurement time		<2s			
Measurement data		2D measurement			
Power supply		220V, 50Hz, 600W			
Illumination system	back light	telecentric illuminator, green light			
	ring light	4-zone circular white high light circular (directional) low-angle green light (electric)			
	coaxial light (optional)	vertical illuminator, white light			
Environmental requirement		temperature: 20°C±2°C, relative humidity: 30%~80%, vibration: <0.002g, less than 15Hz			
Dimension (L×W×H)		532×480×766mm	532×497×766mm	669×510×883mm	
Weight		50kg	60kg	68kg	

* The optimum temperature is 20°C±1°C

① Within 80×64mm, on focal position and environment temperature at 20°C±1°C

② Within 20×16mm, on focal position and environment temperature at 20°C±1°C

③ Within 120×88mm, on focal position and environment temperature at 20°C±1°C

④ Within 40×28mm, on focal position and environment temperature at 20°C±1°C

⑤ Within 180×180mm, on focal position, environment temperature at 20°C±1°C, and workpiece is less than 2kg, L is the travel of stage

⑥ Within 117×117mm, on focal position, environment temperature at 20°C±1°C, and workpiece is less than 2kg, L is the travel of stage

⑦ Within 270×180mm, on focal position, environment temperature at 20°C±1°C, and workpiece is less than 2kg, L is the travel of stage

⑧ Within 207×117mm, on focal position, environment temperature at 20°C±1°C, and workpiece is less than 2kg, L is the travel of stage

⑨ Within 270×189mm, on focal position, environment temperature at 20°C±1°C, and workpiece is less than 2kg, L is the travel of stage

⑩ Within 180×121mm, on focal position, environment temperature at 20°C±1°C, and workpiece is less than 2kg, L is the travel of stage

To be continued

Continued from previous page

- One or more workpieces can be measured by one step operation
- Place workpieces at any position
- Focus and measure automatically
- Measurement of 999+ dimensions and 200+ workpieces
- **QMS-A220** and **QMS-A315** are suitable for small and medium-size parts with high precision requirements
- **QMS-A320** is suitable for medium-size parts with low accuracy requirements and fast efficiency requirements



11.6" LCD (optional)

STANDARD DELIVERY

Main unit	1 pc
Computer	1 pc
Software	1 pc

OPTIONAL ACCESSORY

Coaxial light illumination	QMS-23-A3 (for QMS-A220, QMS-A315) QMS-23-A4 (for QMS-A320)
Data transmission function of software	QMS-23-D1
CAD import function of software	QMS-23-C1
Laser sensor	QMS-43-SJ1 (for QMS-A315)
Foot-switch	QMS-43-FS1
11.6" LCD	QMS-23-B1 (must be installed in factory)

Software (included)

- Automatically measure widths, holes, rings, angles at the same time, simple and efficient

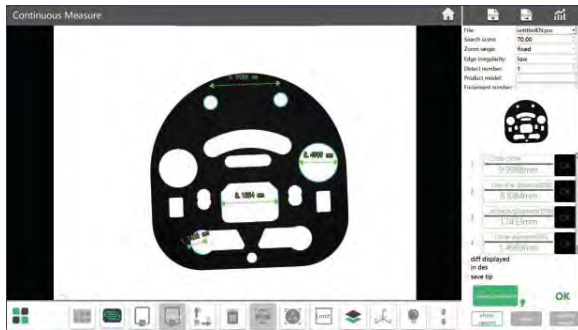

- Measuring result can be stored automatically. OK items and NG items can be counted automatically



NOTE: NOT SUITABLE FOR SMALL SIZES SUCH AS THREADS, CHAMFERS, ETC

QUICK MEASUREMENT SYSTEMS (WITHOUT STITCHING)



QMS-A110



QMS-A200

SPECIFICATION

Code	QMS-A110	QMS-A200	
Optical lens	low-distortion lens, single-field telecentric Ø100mm	dual-field dual-telecentric low-distortion lens wide view field: Ø150mm small view field: Ø50mm	
View field range	100×80mm	wide view field 150×110mm	small view field 50×35mm
Measurement range (X×Y)	98×78mm	148×108mm	48×33mm
Measurement accuracy *	±3µm ①	±5µm ②	±2µm ③
Repeatability	±1µm	±1µm	±0.5µm
Max. weight of workpiece	5kg		
Measurement time	<2s		
Measurement data	2D measurement		
Power supply	220V, 50Hz, 600W		
Illumination system	back light	telecentric illuminator, green light	
	ring light	4-zone circular white high light circular (directional) low-angle green light (electric)	
	coaxial light (optional)	vertical illuminator, white light	
Environmental requirement	temperature: 20°C±2°C, relative humidity: 30%~80%, vibration: <0.002g, less than 15Hz		
Dimension (L×W×H)	580×235×790mm	638×336×885mm	
Weight	40kg	60kg	

* The optimum temperature is 20°C±1°C

- ① Within 80×64mm, on focal position and environment temperature at 20°C±1°C
- ② Within 120×88mm, on focal position and environment temperature at 20°C±1°C
- ③ Within 40×28mm, on focal position and environment temperature at 20°C±1°C

To be continued

Continued from previous page

- One or more workpieces can be measured by one step operation
- Place workpieces at any position
- Focus and measure automatically
- Measurement of 999+dimensions and 200+workpieces
- **QMS-A110** is suitable for measuring small flat parts
- **QMS-A200** is suitable for measuring flat parts with low precision requirements and small surface sizes



11.6" LCD (optional)

STANDARD DELIVERY

Main unit	1 pc
Computer	1 pc
Software	1 pc

OPTIONAL ACCESSORY

Coaxial light illumination	QMS-23-A3 (for QMS-A110) QMS-23-A4 (for QMS-A200)
Data transmission function of software	QMS-23-D1
CAD import function of software	QMS-23-C1
Foot-switch	QMS-43-FS1
11.6" LCD	QMS-23-B1 (must be installed in factory)

Software (included)

- Automatically measure widths, holes, rings, angles at the same time, simple and efficient



- Measuring result can be stored automatically. OK items and NG items can be counted automatically





HIGH-DEFINITION VISION MEASURING SYSTEMS (MANUAL TYPE)

- High-definition image
- Large view field
- Electronic magnification feedback lens: when the objective lens magnification is changed manually, the software automatically selects the corresponding pre-calibration data and calibration is not needed

STANDARD DELIVERY

Main unit	1 pc
Computer	1 pc
Calibration glass chart	1 pc
Clay	1 pc
Foot switch	1 pc
Anti-dust cover	1 pc



ISD-H210

computer is included

SPECIFICATION

Code	ISD-H210	ISD-H320	ISD-H430
Measuring range (X×Y×Z)	200×100×150mm	300×200×150mm	400×300×150mm
Stage size	404×228mm	500×330mm	606×466mm
Glass stage size	260×160mm	350×250mm	450×350mm
Resolution of X/Y/Z axis	0.5µm		
Accuracy of X/Y axis	≤(3.5+L/100)µm (L is the measuring length in mm)		
Repeatability of X/Y axis	2µm		
Objective	0.58X~7.5X (zoom)		
View field (diagonal length)	1.4mm~14mm		
Working distance	82mm		
Magnification	27.4X~351X (on 24" monitor)		
Camera	giga-bit network camera		
Illumination	surface and contour with adjustable LED		
Max. height of workpiece	150mm		
Max. weight of workpiece	20kg		
Operation system	Windows 7/8/10		
Drive method	manual		
Power supply	110~240V, 50/60Hz		
Dimension (L×W×H)	540×560×850mm	760×600×900mm	970×670×940mm
Weight	110kg	140kg	240kg



lens with coaxial light (optional, must be installed in factory)

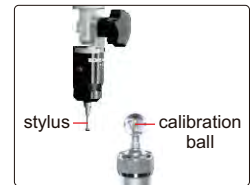

probe (optional), includes Ø2mm and Ø3mm styli, Ø25mm calibration ball, measuring accuracy is 10µm

OPTIONAL ACCESSORY

0.5X auxiliary objective	code: ISD-H-OB05X working distance: 155mm magnification: 13.7~175.5X (on 24" monitor)
2X auxiliary objective	code: ISD-H-OB2X working distance: 34.5mm magnification: 54.8~702X (on 24" monitor)
Probe	code: ISD-V-PROBE includes Ø2mm and Ø3mm styli, Ø25mm calibration ball
Vision measuring system with coaxial light lens	code: ISD-H210CL, ISD-H320CL, ISD-H430CL
Office software	code: 7313-OFFICE

SOFTWARE (INCLUDED)

- Refer to page 521~522 for details

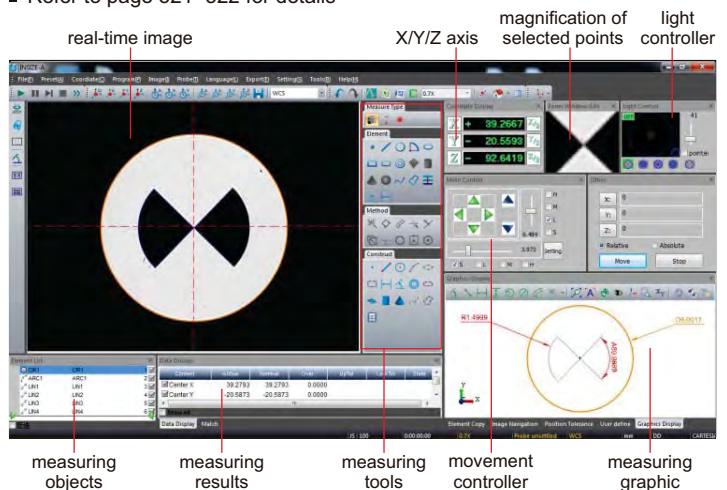

VISION MEASURING SYSTEMS (MANUAL TYPE)



lens with coaxial light (**optional**, must be installed in factory)

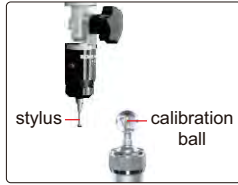

probe (**optional**), includes Ø2mm and Ø3mm styli, Ø25mm calibration ball, measuring accuracy is 10µm



ISD-V250A

computer is included

SPECIFICATION

Code	ISD-V150A	ISD-V250A	ISD-V300A	ISD-V400A
Measuring range (X×Y×Z)	150×100×150mm	250×150×150mm	300×200×150mm	400×300×150mm
Stage size	354×228mm	450×280mm	500×330mm	606×466mm
Glass stage size	210×160mm	306×196mm	350×250mm	450×350mm
Resolution of X/Y/Z axis	0.5µm			
Accuracy of X/Y axis	≤(3.5+L/100)µm (L is the measuring length in mm)			
Repeatability of X/Y axis	2µm			
Objective	0.7X~4.5X (zoom)			
Working distance	92mm			
Magnification	33X~195X (on 19" monitor)			
Camera	1/3" color CCD, 0.3M pixel			
Illumination	surface and contour with adjustable LED			
Max. height of workpiece	150mm			
Max. weight of workpiece	20kg			
Operation system	Windows 7/8/10			
Drive method	manual			
Power supply	110/220V, 50/60Hz			
Dimension (L×W×H)	560×540×850mm	760×600×900mm	760×600×900mm	970×670×940mm
Weight	100kg	120kg	140kg	240kg

23

OPTIONAL ACCESSORY

0.5X auxiliary objective	code: ISD-V-OB05X working distance: 175mm magnification: 16.5~97.5X (on 19" monitor)
2X auxiliary objective	code: ISD-V-OB2X working distance: 36mm magnification: 66~390X (on 19" monitor)
Probe	code: ISD-V-PROBE includes Ø2mm and Ø3mm styli, Ø25mm calibration ball
Vision measuring system with coaxial light lens (with computer)	code: ISD-V150ACL, ISD-V250ACL, ISD-V300ACL, ISD-V400ACL
Office software	code: 7313-OFFICE

STANDARD DELIVERY

Main unit	1 pc
Computer	1 pc
Calibration glass chart	1 pc
Clay	1 pc
Foot switch	1 pc
Anti-dust cover	1 pc

To be continued

Continued from previous page

SOFTWARE (INCLUDED)

- Refer to page 521~522 for details

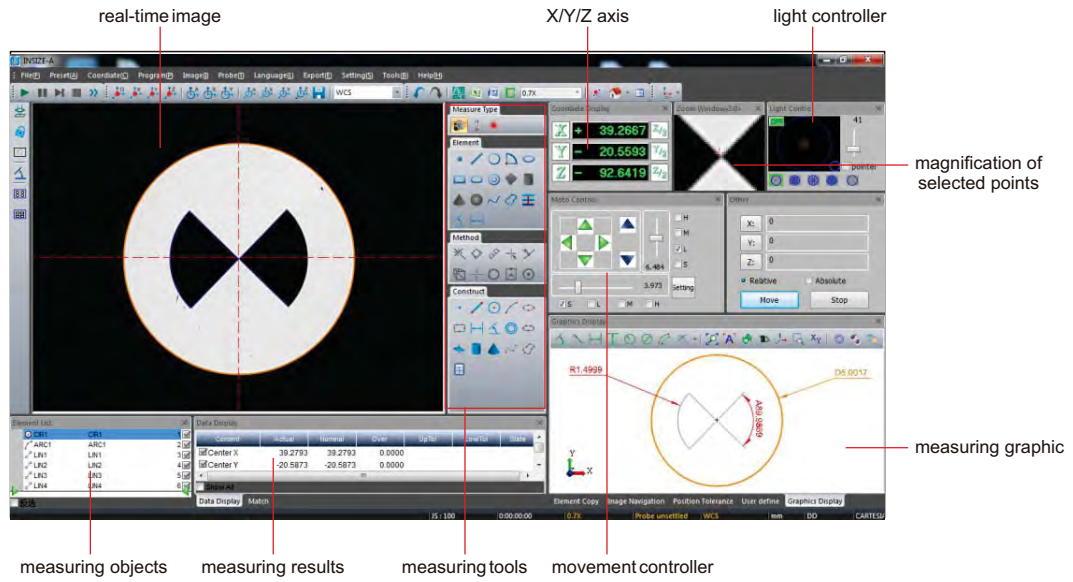

**MOTORIZED ZOOM
OBJECTIVE IS OPTIONAL**

CNC VISION MEASURING SYSTEMS (WITH STAND)

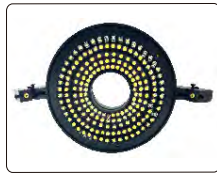

- Automatic edge-detection, focus, measuring, contour scanning, calibration, etc.
- Servo motors for X, Y, Z axis
- Granite body, more stable
- SPC function for large quantity measurement
- Measuring software is included (page 521~522)

STANDARD DELIVERY

Main unit	1 pc
Dongle	1 pc
Software	1 pc
Computer	1 pc
Display	1 pc
Lens with coaxial light	1 pc
Controller	1 pc
Calibration glass chart	1 pc
Laser positioner	1 pc
Clay	1 pc
Anti-dust cover	1 pc



ISD-E320

To be continued

Continued from previous page

SPECIFICATION

Code	ISD-E320	ISD-E430
Measuring range (X×Y×Z)	300×200×200mm	400×300×200mm
Stage size	556×406mm	561×556mm
Glass stage size	350×250mm	450×350mm
Resolution of X/Y/Z axis	0.5µm	
Accuracy of X/Y axis	≤(2.5+L/200)µm (L is measuring length in mm)	≤(3.5+L/200)µm (L is measuring length in mm)
Repeatability of X/Y axis	2µm	
Objective (manual zoom)	0.7X~4.5X (zoom)	
Working distance	92mm	
View field (diagonal length)	1.7~11.1mm	
Magnification	33X~208.6X (on 24" monitor)	
Camera	giga-bit network camera	
Illumination	surface	coaxial light, programmable segmented ring light
	contour	adjustable LED light
Max. height of workpieces	200mm	
Max. weight of workpieces	30kg	
Operation system	Windows 7/8/10	
Drive method	automatic	
Power supply	220V, 50/60Hz	
Dimension (L×W×H)	1420×915×1830mm	1650×1170×1900mm
Weight	500kg	700kg

OPTIONAL ACCESSORY

0.5X auxiliary objective	code: ISD-V-OB05X working distance: 175mm magnification: 16.5~104.3X (on 24" monitor)
2X auxiliary objective	code: ISD-V-OB2X working distance: 36mm magnification: 66~417.2X (on 24" monitor)
Probe	code: ISD-V-PROBE includes Ø2mm and Ø3mm styli, Ø25mm calibration ball
Office software	code: 7313-OFFICE
Laser probe	code: ISD-V-LASER

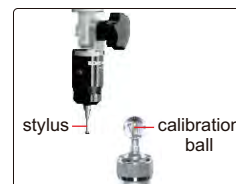

probe (**optional**), includes Ø2mm and Ø3mm styli, Ø25mm calibration ball, measuring accuracy is 10µm



laser probe (**optional**) measuring accuracy is 5µm

SOFTWARE (INCLUDED)

- Refer to page 521~522 for details

The screenshot shows the INSIZE software interface with several key components labeled:

- real-time image:** The main window displays a live video feed of a circular object with a crosshair.
- X/Y/Z axis:** A control panel on the right allows for manual movement of the probe along the X, Y, and Z axes.
- light controller:** A small window on the right provides controls for the measurement lighting.
- magnification of selected points:** A zoomed-in view of the object's features is shown in the bottom right.
- measuring objects:** A list of detected features (AR1, LN1, LN2, LN3, LN4) is shown in the bottom left.
- measuring results:** A table of coordinates and dimensions is displayed in the bottom center.
- measuring tools:** A toolbar on the left provides various measurement and navigation tools.
- movement controller:** A set of directional buttons is located at the bottom center.

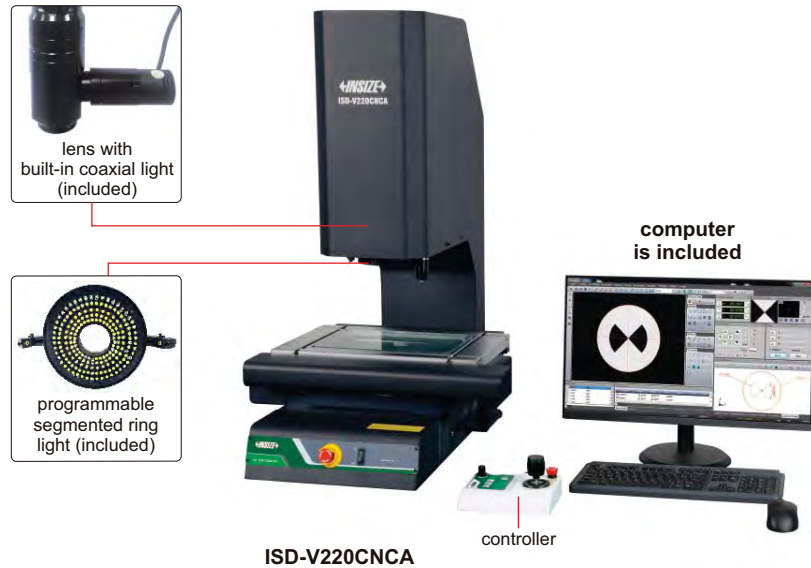

ISD-V220CNCA

- Automatic edge-detection, focus, measuring, contour scanning, calibration, etc.
- Servo motors for X, Y, Z axis
- SPC function for large quantity measurement
- Measuring software is included (page 521~522)

SPECIFICATION

Code	motorized zoom lens	ISD-V220ZA	ISD-V220ZHN	ISD-V270ZA	ISD-V270ZHN	ISD-V370ZA	ISD-V370ZHN	
	manual zoom lens	ISD-V220CNCA	ISD-V220HN	ISD-V270CNCA	ISD-V270HN	ISD-V370CNCA	ISD-V370HN	
Measuring range (X×Y×Z)		220×120×150mm	220×120×300mm	270×170×150mm	270×170×300mm	370×270×150mm	370×270×300mm	
Stage size		450×280mm	450×280mm	500×330mm	500×330mm	606×466mm	606×466mm	
Glass stage size		306×196mm	306×196mm	350×250mm	350×250mm	450×350mm	450×350mm	
Resolution of X/Y/Z axis		0.5µm						
Accuracy of X/Y axis		≤(2.5+L/100)µm (L is the measuring length in mm)				≤(3.5+L/100)µm (L is the measuring length in mm)		
Repeatability of X/Y axis		2µm						
Objective		0.7X~4.5X (zoom)						
Working distance		92mm						
Magnification		33.0X~208.6X (with manual zoom lens, on 24" monitor) 31.9X~188.7X (with motorized zoom lens, on 24" monitor)						
Camera		giga-bit network camera						
Illumination	surface	coaxial light, programmable segmented ring light						
	contour	adjustable LED light						
View field (diagonal length)		1.5~10.8mm						
Max. height of workpiece		150mm	300mm	150mm	300mm	150mm	300mm	
Max. weight of workpiece		30kg						
Operation system		Windows 7/8/10						
Drive method		automatic						
Power supply		220V, 50/60Hz						
Dimension (L×W×H)		760×600×900mm	760×600×1050mm	760×600×900mm	760×600×1050mm	970×670×940mm	970×670×1090mm	
Weight		146kg	156kg	168kg	178kg	266kg	276kg	

To be continued

Continued from previous page



software flash disk (included)

STANDARD DELIVERY

Main unit	1 pc
Software	1 pc
Computer	1 pc
24" display	1 pc
Len with coaxial light	1 pc
Controller	1 pc
Calibration glass chart	1 pc
Laser positioner	1 pc
Clay	1 pc
Anti-dust cover	1 pc

desk (optional)



laser probe (optional) measuring accuracy is 5µm

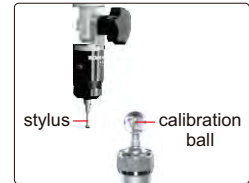

probe (optional), includes Ø2mm and Ø3mm styli, Ø25mm calibration ball, measuring accuracy is 10µm

OPTIONAL ACCESSORY

0.5X auxiliary objective	code: ISD-V-OB05X , working distance: 175mm magnification: 16.5~104.3X (with manual zoom lens, on 24" monitor), 16.0~94.4X (with motorized zoom lens, on 24" monitor)
2X auxiliary objective	code: ISD-V-OB2X , working distance: 36mm magnification: 66~417.2X (with manual zoom lens, on 24" monitor), 63.8~377.4X (with motorized zoom lens, on 24" monitor)
Probe	code: ISD-V-PROBE , includes Ø2mm and Ø3mm styli, Ø25mm calibration ball
Laser probe	code: ISD-V-LASER
Office software	code: 7313-OFFICE
Desk	code: ISD-V-DESK

SOFTWARE (INCLUDED)

- Refer to page 521~522 for details

The screenshot shows the INSIZE software interface with the following components labeled:

- real-time image**: The main viewing area showing a circular object with a crosshair.
- X/Y/Z axis**: The coordinate system controls on the right side.
- light controller**: The light control panel on the right side.
- magnification of selected points**: The numerical display showing magnification values (e.g., 39.2867, 20.5593, 92.6418).
- measuring objects**: The list of measured features at the bottom left.
- measuring results**: The data table at the bottom left showing parameters like Center X, Center Y, etc.
- measuring tools**: The tool palette on the left side.
- movement controller**: The movement control panel on the right side.
- measuring graphic**: The graphical representation of the measured object and its features.

CNC VISION MEASURING SYSTEMS



computer is included

ISD-V500N

- Automatic edge-detection, focus, measuring, contour scanning, calibration, etc.
- Servo motors for X, Y, Z axis
- SPC function for large quantity measurement

SPECIFICATION

Code		ISD-V500N	ISD-V500HN
Measuring range (X×Y×Z)		470×370×200mm	470×370×400mm
Stage size		786×636mm	
Glass stage size		570×470mm	
Resolution of X/Y/Z axis		0.5µm	
Accuracy of X/Y axis		≤(2.5+L/200)µm (L is measuring length in mm)	
Repeatability of X/Y axis		2µm	
Objective		0.7X~4.5X (zoom)	
Working distance		92mm	
View field (diagonal length)		1.5~10.8mm	
Magnification		33.0X~208.6X (on 24" monitor)	
Camera		giga-bit network camera	
Illumination	surface	coaxial light, programmable segmented ring light	
	contour	adjustable LED light	
Max. height of workpieces		200mm	400mm
Max. weight of workpieces		30kg	
Operation system		Windows 7/10	
Drive method		automatic	
Power supply		220V, 50/60Hz	
Dimension (L×W×H)		1270×1200×1870mm	1270×1200×2070mm
Weight		870kg	900kg

To be continued

Continued from previous page

STANDARD DELIVERY

Main unit	1 pc
Video card with dongle	1 pc
Software disc	1 pc
Lens with coaxial light	1 pc
Controller	1 pc
Computer	1 pc
Calibration glass chart	1 pc
Laser positioner	1 pc
Clay	1 pc
Anti-dust cover	1 pc



lens with coaxial light (included)

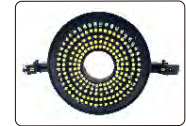

programmable segmented ring light (included)

OPTIONAL ACCESSORY

0.5X auxiliary objective	code: ISD-V-OB05X working distance: 175mm magnification: 16.5~104.3X (on 24" monitor)
2X auxiliary objective	code: ISD-V-OB2X working distance: 36mm magnification: 66~417.2X (on 24" monitor)
Probe	code: ISD-V-PROBE includes Ø2mm and Ø3mm styli, Ø25mm calibration ball
Office software	code: 7313-OFFICE

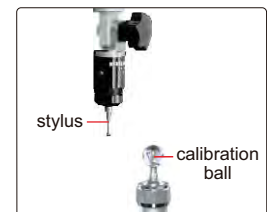

probe (**optional**), includes Ø2mm and Ø3mm styli, Ø25mm calibration ball, measuring accuracy is 10µm

SOFTWARE (INCLUDED)

- Refer to page 521~522 for details

The screenshot displays the INSIZE software interface with several key components labeled:

- real-time image:** The main window showing a live video feed of a circular target with two black lobes.
- X/Y/Z axis:** A 3D coordinate system overlay on the image.
- light controller:** A panel on the right side of the interface for adjusting the lighting.
- magnification of selected points:** A zoomed-in view of the target's center points.
- measuring objects:** The two black lobes of the target being measured.
- measuring results:** A data table at the bottom left showing parameters like Center X, Center Y, and Radius.
- measuring tools:** A toolbar on the left side of the interface.
- movement controller:** A panel on the right side for controlling the probe's movement.
- measuring graphic:** A diagram at the bottom right showing the measurement path and results.

MOTORIZED ZOOM
OBJECTIVE IS OPTIONAL

CNC VISION MEASURING SYSTEMS



VMM-L1001CN

- Automatic edge-detection, focus, measuring, contour scanning, calibration, etc.
- Servo motors for X, Y, Z axis, X, Y axis adopt linear guide rail structure, without air supply
- Fixed glass table and granite platform base, good stability
- SPC function for large quantity measurement
- Measuring software is included (page 521~522)

SPECIFICATION

Code	VMM-L600CN	VMM-L601CN	VMM-L800CN
Measuring range (X*Y*Z)	600×600×200mm	600×900×200mm	800×1000×200mm
Glass stage size	765×1238mm	702×1543mm	902×1643mm
Resolution of X/Y/Z axis	0.5μm		
Accuracy of X/Y axis	≤(3.5+L/200)μm (L is measuring length in mm)		
Repeatability of X/Y axis	2μm		
Objective (manual zoom)	0.7X~4.5X (zoom)		
Working distance	92mm		
View field (diagonal length)	1.7~11.1mm		
Magnification	33.0X~208.6X (on 24" monitor)		
Camera	giga-bit network camera		
Illumination	surface	coaxial light, programmable segmented ring light	
	contour	adjustable LED light	
Max. height of workpiece	200mm		
Max. weight of workpiece	35kg		
Operation system	Windows 7/8/10		
Drive method	automatic		
Power supply	AC 220V, 50/60Hz		
Dimension (L*W*H)	1445×1185×1560mm	1745×1220×1720mm	1850×1420×1720mm
Weight	1000kg	1400kg	2200kg

To be continued

Continued from previous page

SPECIFICATION

Code	VMM-L1000CN	VMM-L1001CN	VMM-L1200CN
Measuring range (X×Y×Z)	1000×1200×200mm	1000×1500×200mm	1200×1500×200mm
Glass stage size	1100×1831mm	1100×2113mm	1300×2113mm
Resolution of X/Y/Z axis	0.5µm		
Accuracy of X/Y axis	≤(3.5+L/200)µm (L is measuring length in mm)		
Repeatability of X/Y axis	2µm		
Objective(manual zoom)	0.7X~4.5X (zoom)		
Working distance	92mm		
View field (diagonal length)	1.7~11.1mm		
Magnification	33.0X~208.6X (on 24" monitor)		
Camera	giga-bit network camera		
Illumination	surface	coaxial light, programmable segmented ring light	
	contour	adjustable LED light	
Max. height of workpiece	200mm		
Max. weight of workpiece	30kg		
Operation system	Windows 7/8/10		
Drive method	automatic		
Power supply	AC 220V, 50/60Hz		
Dimension (L×W×H)	2035×1590×1720mm	2315×1590×1720mm	2315×1790×1720mm
Weight	2900kg	3200kg	4000kg



programmable segmented ring light (included)



lens with coaxial light (included)

STANDARD DELIVERY

Main unit	1 pc
Dongle	1 pc
Computer	1 pc
Software	1 pc
Display	1 pc
Lens with coaxial light	1 pc
Controller	1 pc
Calibration glass chart	1 pc
Laser positioner	1 pc
Clay	1 pc
Anti-dust cover	1 pc



probe (**optional**), includes Ø2mm and Ø3mm styli, Ø25mm calibration ball, measuring accuracy is 10µm



laser probe (**optional**) measuring accuracy is 5µm

OPTIONAL ACCESSORY

0.5X auxiliary objective	code: ISD-V-OB05X working distance: 175mm magnification: 16.5~104.3X (on 24" monitor)
2X auxiliary objective	code: ISD-V-OB2X working distance: 36mm magnification: 66~417.2X (on 24" monitor)
Probe	code: ISD-V-PROBE includes Ø2mm and Ø3mm styli, Ø25mm calibration ball
Laser probe	code: ISD-V-LASER
Office software	code: 7313-OFFICE

SOFTWARE FOR VISION MEASURING SYSTEMS
 ISD-V SERIES, ISD-H SERIES, ISD-VMM SERIES,
 ISD-E SERIES AND VMM-L SERIES

VISION MEASURING SOFTWARE

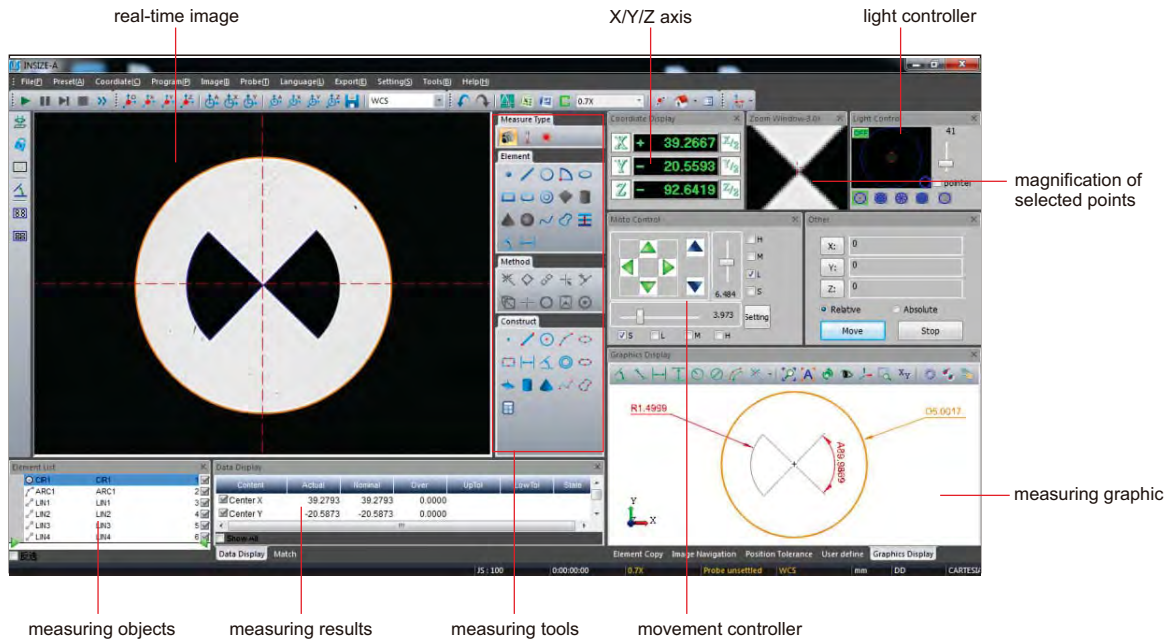

- Operation system: Windows 7/10
- Language: English
- Control features: assistant focus (manual machines), auto focus (CNC machines), auxiliary light control, motion controlled by mouse (CNC machines), auto zoom lens (CNC machines)
- Image measuring methods: intelligent automatic edge detect, select points of an area, select points from multiple parts, select points via mouse, select adjacent points, select points via cross line, magnify to select points, comparatively select points, select points via probe, edge point, contour point
- Constructable elements: point, line, circle, arc, ellipse, rectangle, distance, angle, ring, slot, plane, cone, open curve, closed curve
- Support fixture (CNC machines), scanning, image navigation, user define, pixel calibration
- Measuring by image and probe, image and probe can be synchronized
- Measuring data can be sent to Excel, Word, SPC, measuring elements can be sent to dxf

Dimension measuring tools:

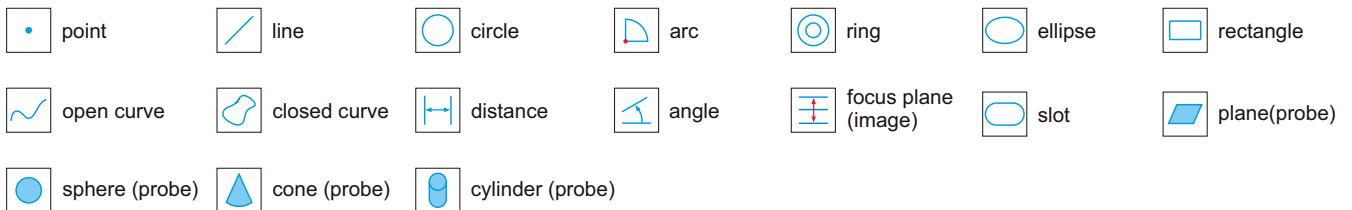

Geometric measuring tools:



To be continued

Continued from previous page

Measuring and element construct methods:

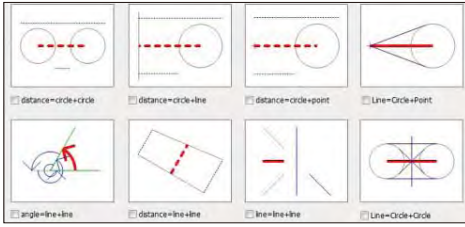

Sent to CAD, EXCEL, WORD

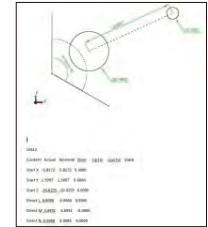
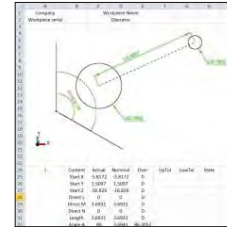
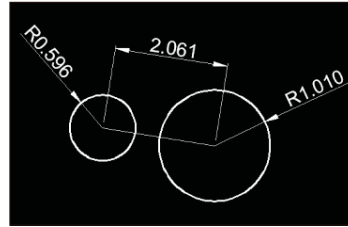

CAD

EXCEL

WORD

Edge-detection:

point tool

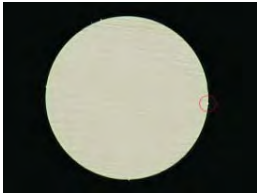

box tool

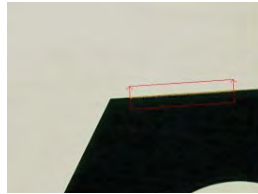

circle tool

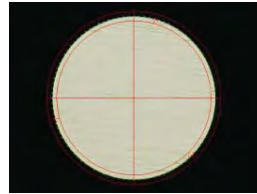

Contour scanning:

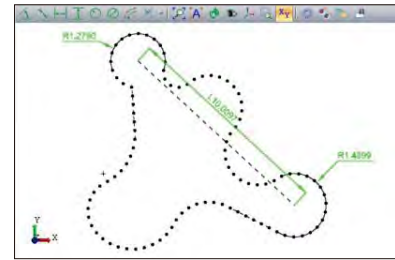

CAD measuring:

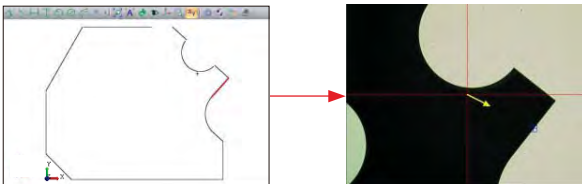

import CAD drawing, set the datum, establish coordinate system, then the software will automatically measure

CAD comparison:

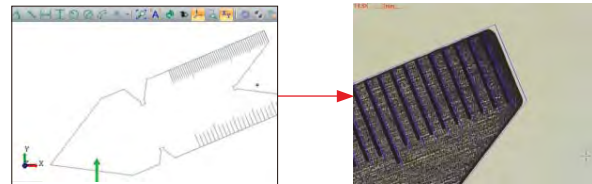

import CAD drawing, then compare with real-time image

Profile scanning:



SPC analysis, import the measuring data to SPC module, generate Xbar-R chart, Xbar-S chart, Mid-R chart, X-Rs chart, Histogram, Sigma A and Sigma S chart, Cpk process chart, Process state analyse chart, Single process advice analyse chart

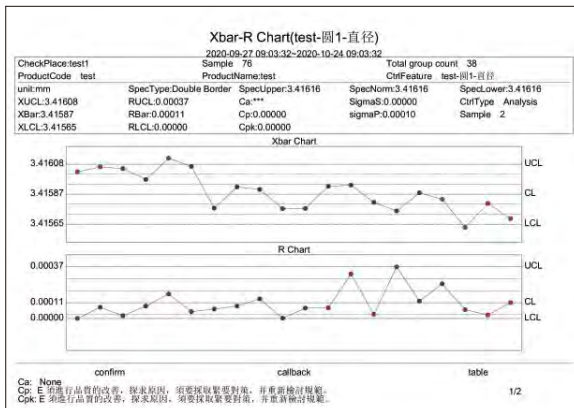

Xbar-R chart

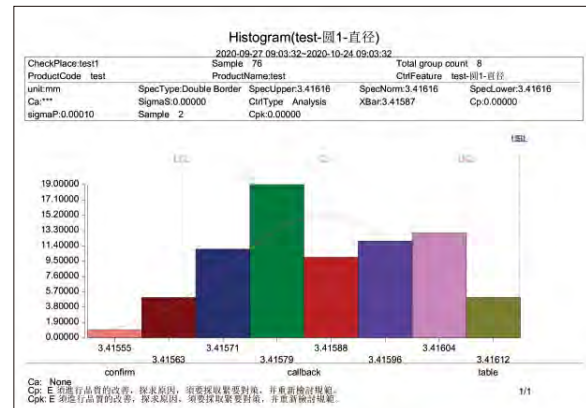

Histogram



JIG SET FOR VISION MEASURING SYSTEMS CODE ISY-700

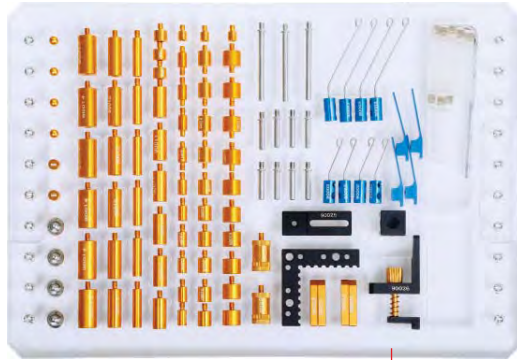

acrylic tray (included)

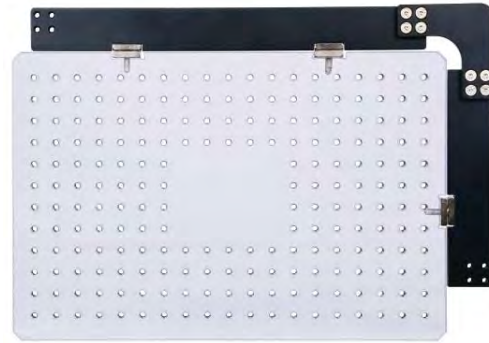

ISY-700

application example

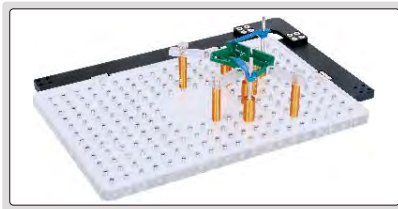

Product	Code	Size (mm)	Quantity
clip	ISY-700-90001	7×34	4
clip	ISY-700-90002	Ø1.5×24	4
	ISY-700-90003	Ø1.5×50	4
clip stand	ISY-700-90004	Ø4×20	8
	ISY-700-90005	Ø4×46	3
spherical support head	ISY-700-90006	—	4
stand	ISY-700-90007	Ø6×10	6
	ISY-700-90008	Ø6×25	6
	ISY-700-90019	Ø6×6	3
stand	ISY-700-90009	Ø9×7	3
	ISY-700-90010	Ø9×10	6
	ISY-700-90011	Ø9×20	6
	ISY-700-90012	Ø9×25	6
stand	ISY-700-90013	Ø12×10	6
	ISY-700-90014	Ø12×25	6
stand for slice parts	ISY-700-90015	Ø6×10	4
	ISY-700-90016	Ø9×10	4
	ISY-700-90017	Ø12×10	4
stand with fine adjustment	ISY-700-90018	Ø12×20~25	2

Product	Code	Size (mm)	Quantity
adapter for square support	ISY-700-90020	—	2
clamping screw	ISY-700-90021	—	4
L-shaped positioning plate	ISY-700-90022	50×50×6	1
sliding support plate	ISY-700-90023	30×12×5	4
square support	ISY-700-90024	20×16×16	1
base for square support	ISY-700-90025	45×16×6	1
spring stand	ISY-700-90026	—	1
acrylic sliding support plate	ISY-700-90028	45×12×5	8
wrench	ISY-700-90029	M3	1
acrylic base plate	ISY-700-90030	300×200×12 Hole size: M4X0.7	1

STANDARD GLASS SCALES



ISD-CL300A

- To calibrate optical measuring instruments, also can be used as optical positioning elements in precision machine tools

STANDARD TYPE

Code	Measuring range	Graduation	Length	Width	Thickness	Accuracy
ISD-CL100A	100mm	1mm	130mm	30mm	5mm	1µm
ISD-CL200A	200mm	1mm	230mm	30mm	5mm	1µm
ISD-CL300A	300mm	1mm	330mm	30mm	5mm	1µm
ISD-CL400A	400mm	1mm	430mm	30mm	5mm	1µm
ISD-CL500A	500mm	1mm	530mm	30mm	5mm	2µm

23

ECONOMIC TYPE

Code	Measuring range	Graduation	Length	Width	Thickness	Accuracy
ISD-CL100B	100mm	1mm	130mm	30mm	5mm	3µm
ISD-CL200B	200mm	1mm	230mm	30mm	5mm	3µm
ISD-CL300B	300mm	1mm	330mm	30mm	5mm	3µm
ISD-CL400B	400mm	1mm	430mm	30mm	5mm	3µm
ISD-CL500B	500mm	1mm	530mm	30mm	5mm	3µm

PROFESSIONAL TYPE (The scale is between two layers of glass and will not be worn off)

Code	Measuring range	Graduation	Length	Width	Thickness	Accuracy
ISD-CL100S	100mm	1mm	130mm	30mm	10mm	1µm
ISD-CL200S	200mm	1mm	230mm	30mm	10mm	1.5µm
ISD-CL300S	300mm	1mm	330mm	30mm	15mm	2.5µm
ISD-CL400S	400mm	1mm	430mm	30mm	15mm	3µm
ISD-CL500S	500mm	1mm	530mm	30mm	15-25mm	3.5µm



Toolmaker Microscopes
Page 526-527



Digital Microscopes
Page 528-562



Cutting Tools Microscopes
Page 549



Industrial Microscopes
Page 563-564



Metallurgical Microscopes
Page 565-568



Zoom Stereo Microscopes
Page 569-575



Polarizing Microscopes
Page 576



Digital Cameras For Microscopes
Page 577-585

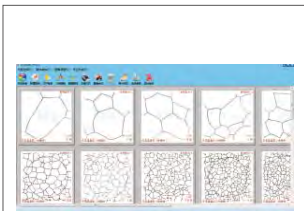

Metallurgical Analysis Softwares
Page 584-585



Portable Measuring Microscopes
Page 586



Table Magnifiers With Illumination
Page 587



Digital Magnifiers
Page 588-589

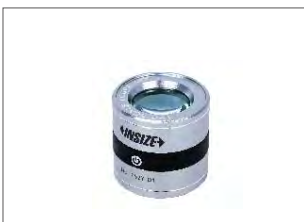

Magnifiers
Page 590-594



Telescoping Inspection Mirrors
Page 594



Telescoping Pick-up
Page 595

TOOLMAKER MICROSCOPES



10X dividing eyepiece

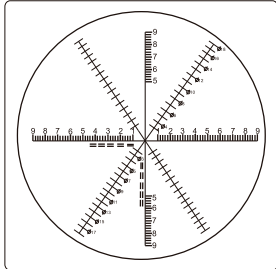

the horizontal and vertical scale lines are used for length measurement, the graduation is 0.2mm. the two diagonals scale lines are used for diameter measurement, the graduation is 1mm (when using 1X objective)

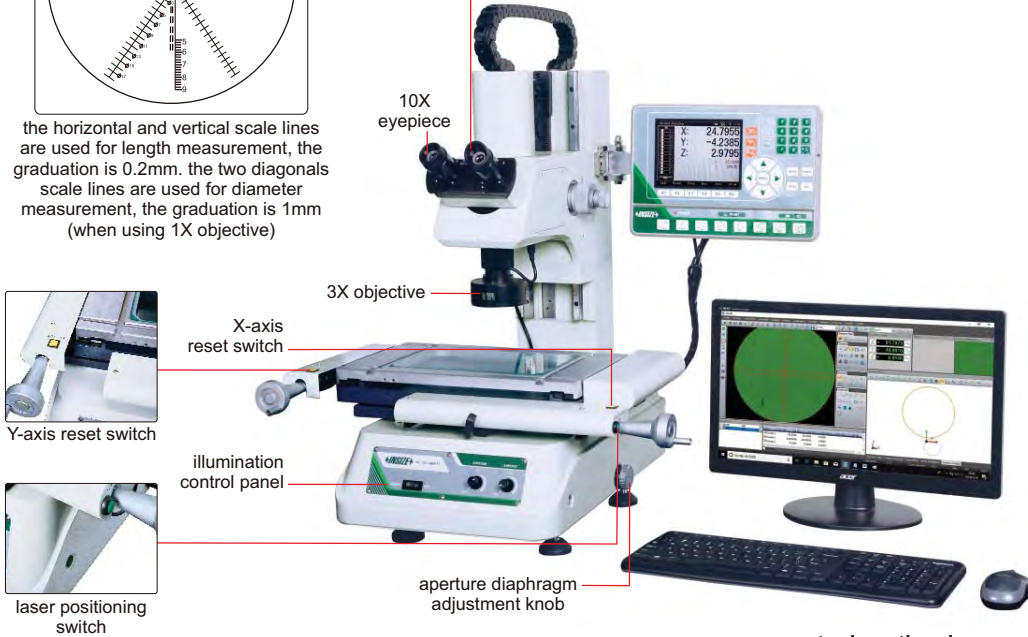

computer is optional

ISD-VMM215











SPECIFICATION

Code	binocular	ISD-VMM205	ISD-VMM215	ISD-VMM225	ISD-VMM235
	monocular	ISD-VMM205D	ISD-VMM215D	ISD-VMM225D	ISD-VMM235D
X/Y axis travel		150×100mm	200×100mm	250×150mm	300×200mm
Z axis travel		150mm	150mm	200mm	200mm
Metal stage size		354×228mm	404×228mm	450×280mm	500×330mm
Glass stage size		210×160mm	260×160mm	306×196mm	350×250mm
Resolution of X/Y/Z axis		0.5µm			
Accuracy of X/Y axis		≤(3.5+L/100)µm (L is the measuring length in mm)			
Repeatability		2µm			
Camera		1/3" color CCD, 0.3M pixel			
Optical magnification		30X (with 3X objective)			
Image magnification		114X (on 19" monitor)			
Illumination		surface and contour with adjustable LED			
Max. weight of workpiece		25kg			
Power supply		100V~240V, 50/60Hz			
Operation system		Windows 7/8/10			
Drive method		manual			
Dimension (L×W×H)		540×667×850mm	540×667×850mm	800×675×920mm	800×675×920mm
Weight		100kg	110kg	135kg	140kg

To be continued

Continued from previous page

DATA PROCESSING UNIT

Output	RS232
Function	 simple measuring tools
	 measure coordinate of points
	 measure lines
	 measure center coordinate, radius of circle with three points
	 measure distances between two objects
	 measure angles
	 set origin of coordinate
	 skew and calibrate the workpiece
	 measure rectangle (including length, width, perimeter and center coordinate)
	 measure thread (including thread diameter, screw pitch, screw angle)
 measure slot (including center coordinate, length, width)	

STANDARD DELIVERY

Main unit	1 pc
Video card with dongle	1 pc
Software disc	1 pc
Calibration glass chart	1 pc
Demo sample	1 pc
Foot switch	1 pc
3X objective	1 pc

OPTIONAL ACCESSORY

1X objective	ISD-VMM-LENS1X
5X objective	ISD-VMM-LENS5X
10X objective	ISD-VMM-LENS10X
Toolmaker microscopes (with computer)	code: ISD-VMM205A (binocular) ISD-VMM215A (binocular) ISD-VMM225A (binocular) ISD-VMM235A (binocular)
	code: ISD-VMM205DA (monocular) ISD-VMM215DA (monocular) ISD-VMM225DA (monocular) ISD-VMM235DA (monocular)

SOFTWARE (INCLUDED)

- Refer to page 521~522 for details

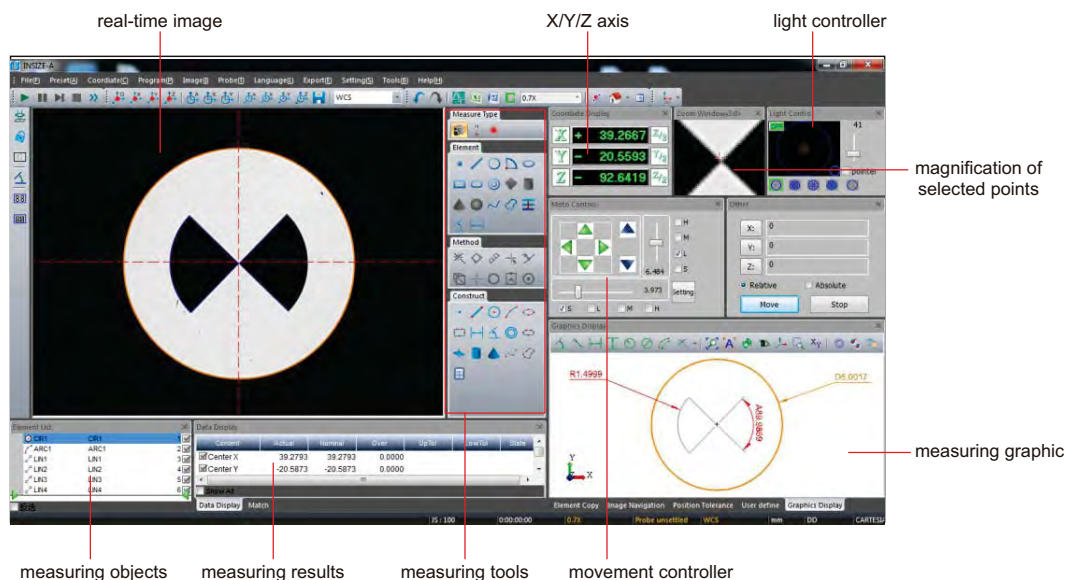

AUTO FOCUS DIGITAL MICROSCOPES (LARGE VIEW FIELD)

TAKE PICTURES AND VIDEOS

MEASUREMENT

CAN BE CONNECTED TO PC AND TV AT THE SAME TIME

AUTO FOCUS



connect to computer through cable to save pictures (software for computer is included)



optical zoom adjustment

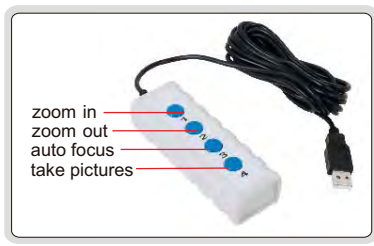

controller (optional, for TV)

- Auto focus camera
- Take pictures and videos
- Can be connected to TV (HDMI port) and computer (RJ45 port) at the same time
- Built-in measuring software for TV
- Measuring software for computers is included
- Automatic exposure and white balance
- Brightness, contrast ratio, gain are adjustable
- Display cross hair (blue/green/red /yellow/black/brown colors)

TV SOFTWARE (INCLUDED)

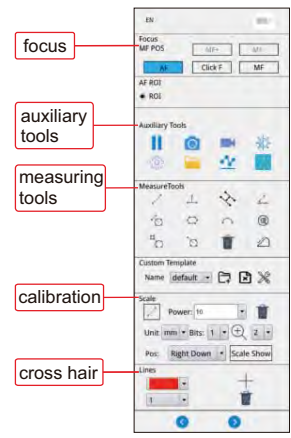

SPECIFICATION

Code	5302-AF105 (standard type)	5302-AF108 (high-definition type)
Pixel	2M	8M
Resolution	1920×1080	3840×2160
Magnification	1.4X~25.8X (on 28" TV)	1.4X~51.6X (on 28" TV)
Sensor	1/2.8" CMOS	
Auto focus distance	100mm~∞	
Output	HDMI, RJ45	
Frame rate	HDMI: 60fps, RJ45: 50fps	
Power supply	power adapter	
Dimension (L×W×H)	500×280×410mm	
Weight	17kg	

VIEW FIELD

Focus distance	Adjustable magnification (on 28" TV)	View field
100mm	3.9~25.8X	24×14~168×91mm
150mm	2.6~20X	30×17~240×128mm
200mm	2.1~17X	37×20~315×170mm
250mm	1.7~14.7X	42×24~385×210mm
270mm	1.4~14X	43×25~415×225mm

MEASURING ACCURACY

Optical magnification (5302-AF105)	Optical magnification (5302-AF108)	Measuring accuracy
2X	2X	±0.1mm
4X	4X	±0.1mm
6X	6X	±0.04mm
8X	8X	±0.02mm
14X	14X	±0.02mm
/	28X	±0.02mm

STANDARD DELIVERY

Main unit (with stand)	1 pc
LED illumination	1 pc
16G USB flash disk	1 pc
Mouse	1 pc
HDMI cable (for TV)	1 pc
Network cable (for computer)	1 pc
Switch	1 pc
Software for computer	1 pc
Power adapter	2 pcs

OPTIONAL ACCESSORY

28" 4K TV	5302-AF-TV28
32" 4K TV	5302-AF-TV32
Computer	5302-AF-COMPUTER
Controller	5302-AF-CONTROLLER

IMAGE STITCHING

DUAL SCREEN OPERATION

FOCUS STACKING

HIGH-DEFINITION AUTO FOCUS MEASURING MICROSCOPE CODE 5315-S710

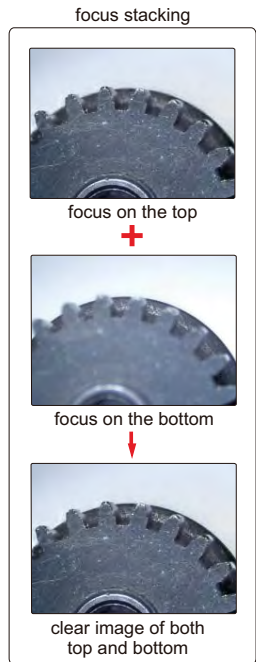
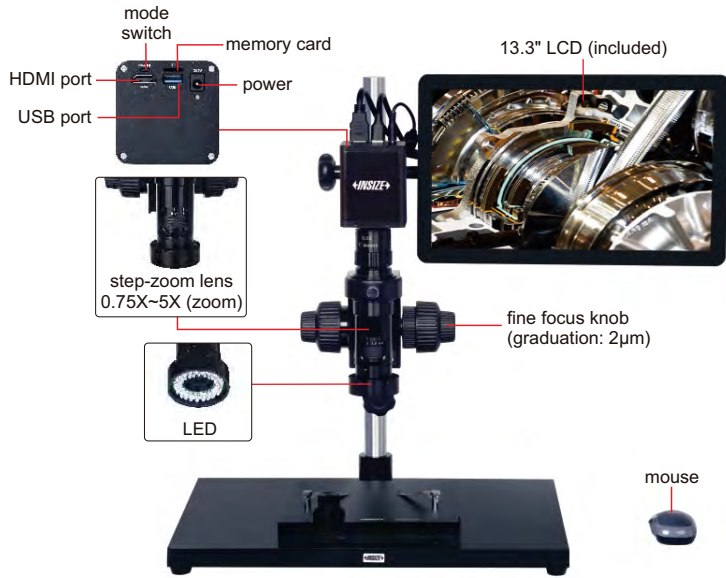

- 12M high-definition image
- Switchable LCD mode and computer mode
- Take pictures or videos, save to memory card
- Measurement results can be sent to Excel
- Auto focus
- Automatic white balance and exposure



calibration plate (included)



1X camera adapter (optional)



2X auxiliary objective (optional)

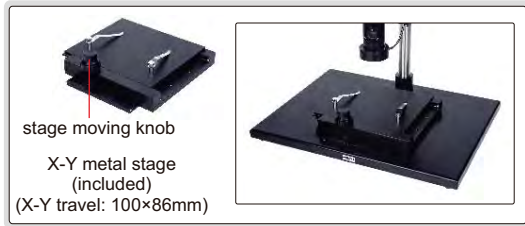
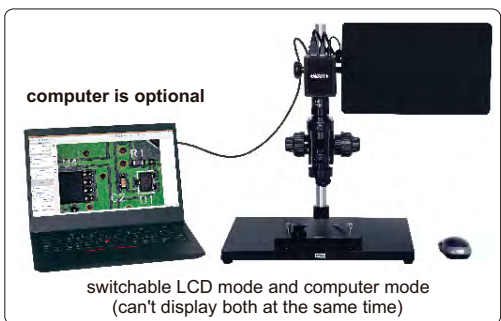
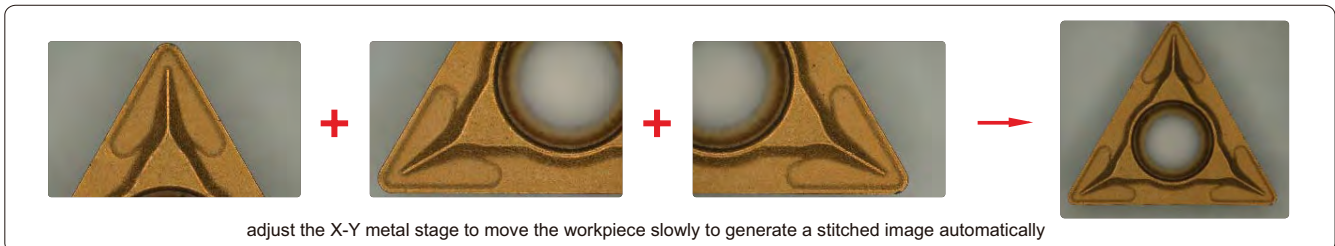

image stitching



To be continued

Continued from previous page

SPECIFICATION

Magnification	15X~100X (on 13.3" LCD)
Sensor	1/1.7" CMOS
Pixel	12M
Resolution	1920×1080
Frame rate	30fps
Output	HDMI/USB
Power supply	power adapter
Dimension (L×W×H)	570×300×430mm

STANDARD DELIVERY

Main unit	1 pc
0.5X camera adapter	1 pc
1X auxiliary objective	1 pc
Calibration plate	1 pc
32G memory card	1 pc
Mouse	1 pc
X-Y metal stage	1 pc

MAGNIFICATION AND MEASURING ACCURACY (on 13.3" LCD)

Objective magnification	Image magnification	Measuring accuracy
0.75X	15X	±20µm
1X	20X	±20µm
1.5X	30X	±20µm
2X	40X	±20µm
2.5X	50X	±20µm
3X	60X	±20µm
3.5X	70X	±20µm
4X	80X	±10µm
4.5X	90X	±10µm
5X	100X	±10µm

MAGNIFICATION, FOCUS DISTANCE AND VIEW FIELD (on 13.3" LCD)

Specification	Camera adapter	
	0.5X (included)	1X (optional)
Magnification	15~100X	30~200X
Focus distance	80±2mm	80±2mm
View filed	20.0×11.2~5.5×3.1mm	10.0×5.6~2.7×1.5mm

OPTIONAL ACCESSORY

1X camera adapter	ISM-DL-CA1X
2X auxiliary objective	ISM-DL-OB2X
Computer	ISM-DL-COMPUTER
LED light	page 553~554
Auxiliary objective	page 555

SOFTWARE FOR LCD (INCLUDED)

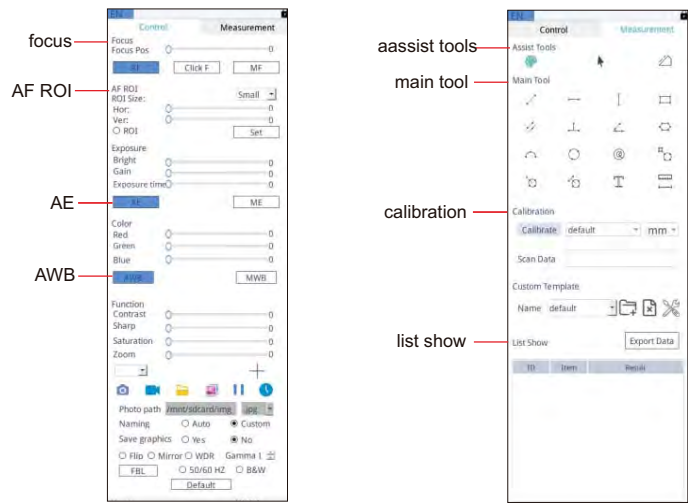

SOFTWARE FOR COMPUTER (INCLUDED)

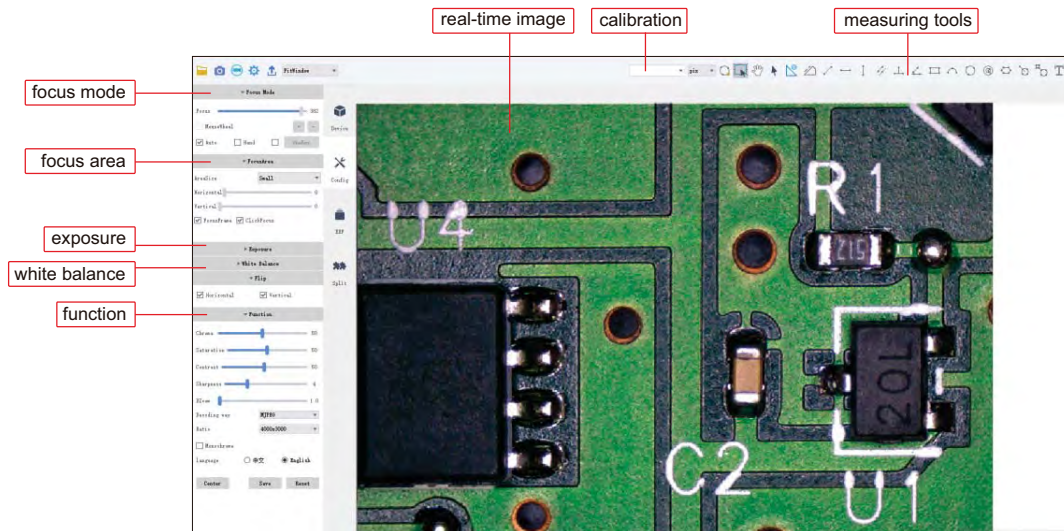

AUTO FOCUS **TAKE PICTURES AND VIDEOS** **MEASUREMENT**

AUTO FOCUS DIGITAL MICROSCOPE CODE 5303-AF103

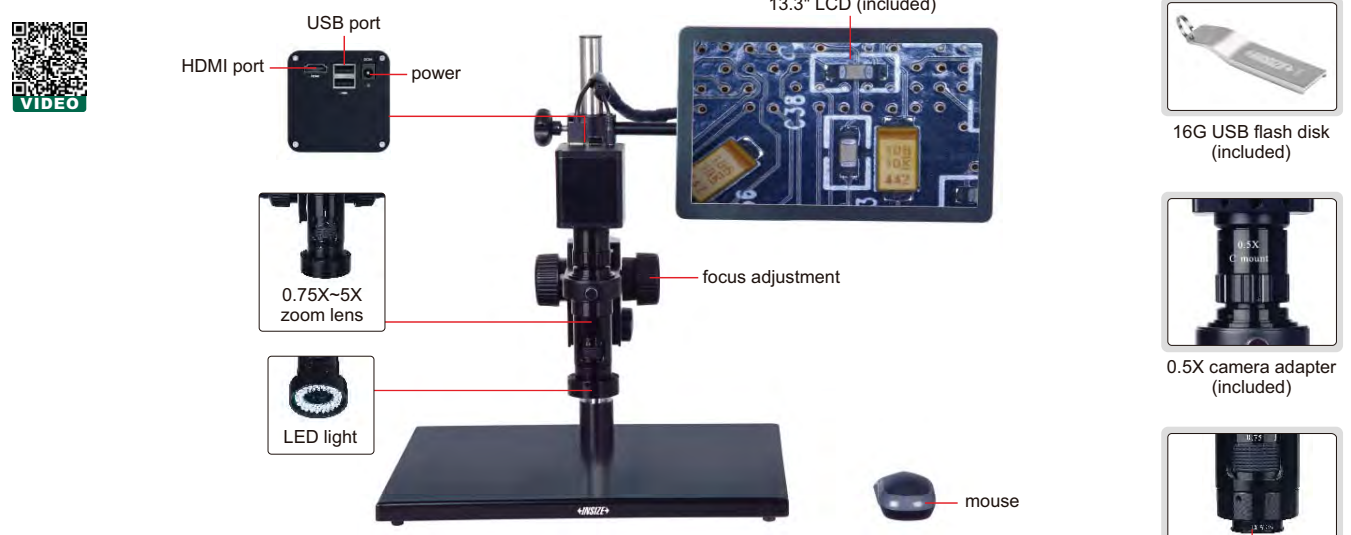

- 1080P high-definition image
- Auto focus camera
- Take pictures and videos, saved to USB flash disk
- Picture review, picture compare
- Automatic exposure and white balance
- Brightness, contrast ratio, gain are adjustable
- Display cross hair (blue/green/red/yellow/black/ brown colors)
- Built-in software without computer, operation by mouse

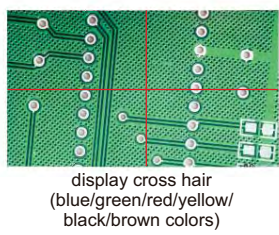
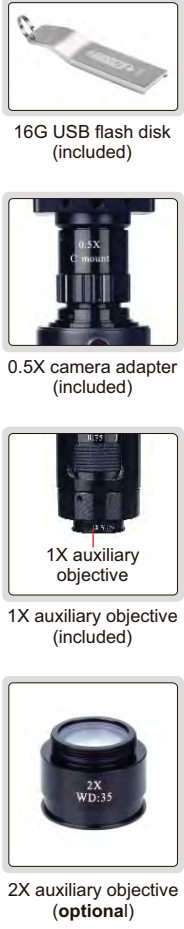

MAGNIFICATION, FOCUS DISTANCE AND VIEW FIELD

Auxiliary objective	Specification	Camera adapter	
		0.5X (included)	1X (optional)
1X (included)	magnification	20~123X	40~246X
	focus distance	48~84mm	48~84mm
	view field	13×7~2.2×1mm	6.3×3.5~1.1×0.5mm
2X (optional)	magnification	40~246X	80~492X
	focus distance	24~42mm	24~42mm
	view field	6.5×3.5~1.1×0.5mm	3.3×1.8~0.6×0.3mm
	measuring accuracy	±0.02mm	±0.02mm

SPECIFICATION

Magnification	20X~123X
Sensor	1/2.8" CMOS
Pixel	2M
Resolution	1920×1080
Frame rate	60fps
Output	HDMI
Power supply	power adapter
Dimension (L×W×H)	570×300×430mm
Weight	6.5kg

AUTO FOCUS DISTANCE

Zoom objective scale	0.75X	1X	1.5X	2X	2.5X
Auto focus distance	48~84mm	50~78mm	55~73mm	62~71mm	65~70mm
Zoom objective scale	3X	3.5X	4X	4.5X	5X
Auto focus distance	66~70mm	67~70mm	68~70mm	68~70mm	68~70mm

STANDARD DELIVERY

Main unit	1 pc
0.5X camera adapter	1 pc
1X auxiliary objective	1 pc
Calibration plate	1 pc
16G USB flash disk	1 pc
White/black plate	1 pc
Mouse	1 pc
HDMI cable	1 pc
Power adpter	2 pcs

OPTIONAL ACCESSORY

1X camera adapter	ISM-DL-CA1X
2X auxiliary objective	ISM-DL-OB2X
X-Y glass stage (travel: 100×86mm)	ISM-DL-STAGE
X-Y metal stage	ISM-DL-STAGE1
LED light	page 553~554
Auxiliary objective	page 555

3D MOTORIZED ROTATION MICROSCOPE CODE 5301-D400

SUITABLE TO CHECK CONVEX
OBJECTS AND WALL OF HOLE

TAKE PICTURES
AND VIDEOS

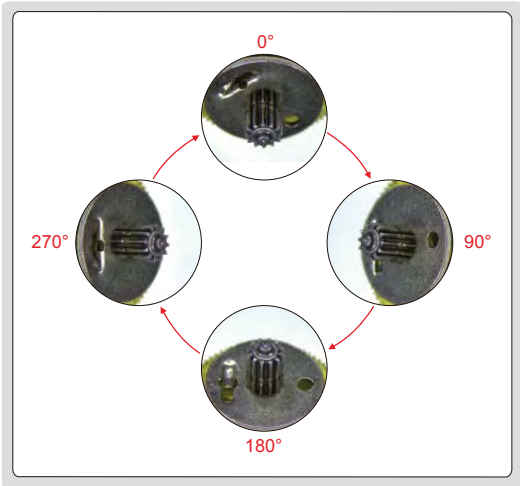
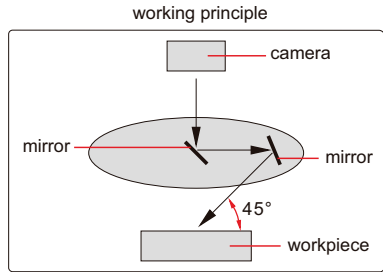
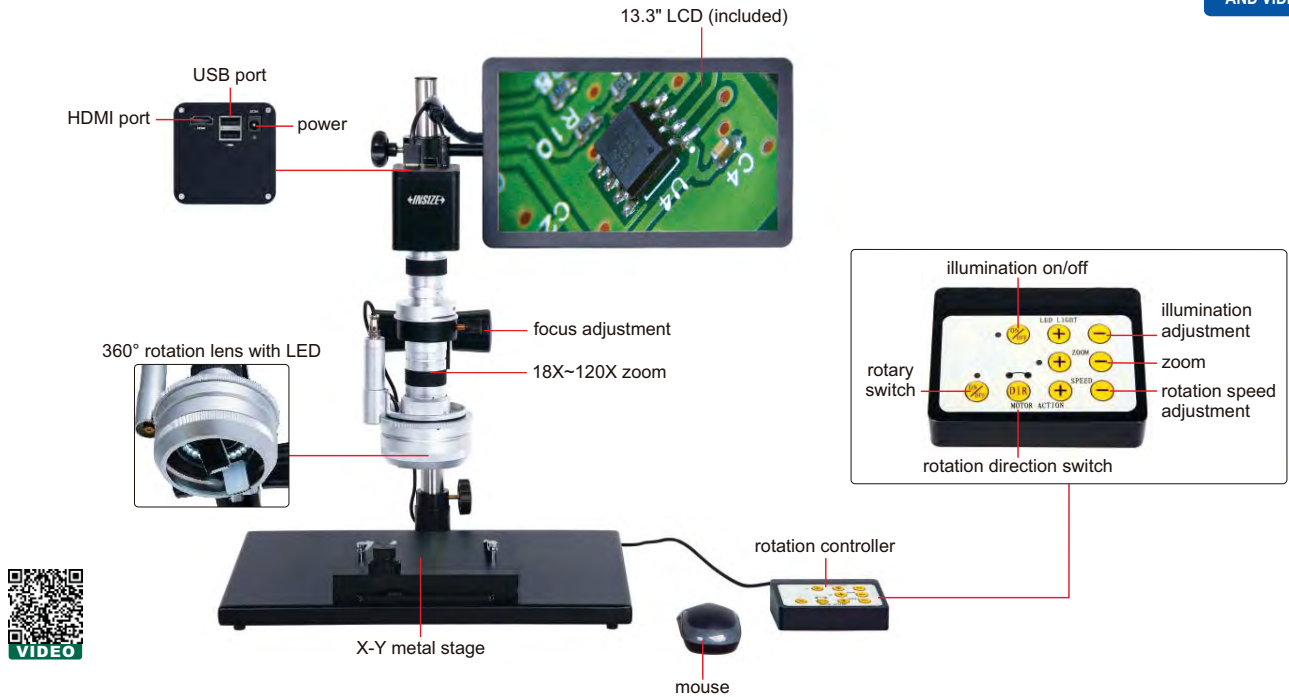

360° rotation observation

24

- 1080P high-definition 3D image
- Take pictures and videos, save to USB flash disk
- Automatic white balance and exposure
- Brightness, contrast ratio and gain are adjustable

SPECIFICATION

Magnification	18X~120X
View field	2.4×1.5mm~16×9mm
Focus distance	20mm
View angle	45°
Sensor	1/2.8" CMOS
Pixel	2M
Resolution	1920×1080
Frame rate	60fps
Output	HDMI
Rotation speed	2~5RPM
Power supply	110/220V, 50/60Hz
Dimension (L×W×H)	570×300×430mm
Weight	10kg

STANDARD DELIVERY

Main unit	1 pc
Rotation controller	1 pc
X-Y metal stage	1 pc
16G USB flash disk	1 pc
White/black plate	1 pc
Mouse	1 pc
Power adapter	2 pcs

SUITABLE TO CHECK CONVEX OBJECTS
AND WALL OF HOLES

TAKE PICTURES AND VIDEOS

3D MANUAL ROTATION MICROSCOPE CODE 5313-S407

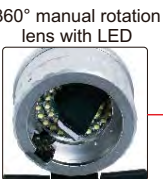
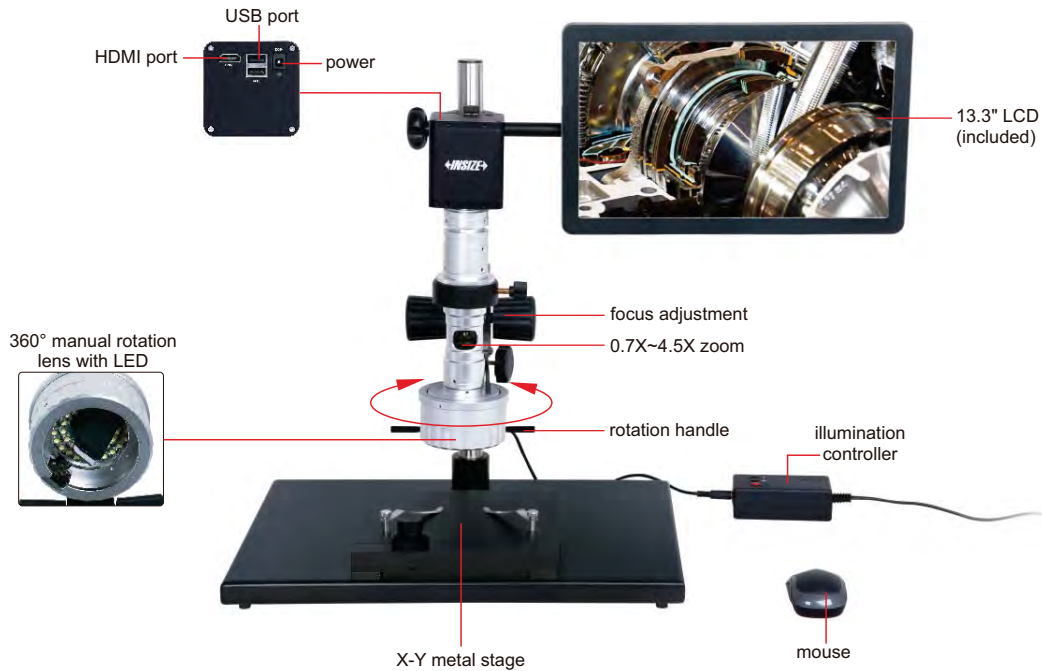

360° manual rotation lens with LED

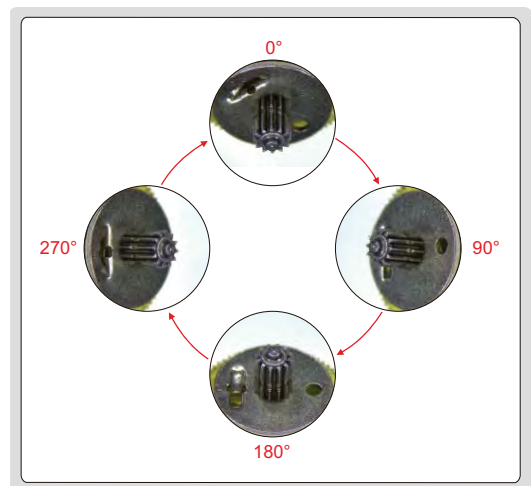
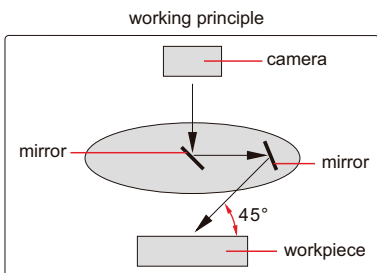

360° rotation observation

SPECIFICATION

Magnification	18X~120X
View field	2.4×1.5mm~16×9mm
Focus distance	20mm
View angle	45°
Sensor	1/2.8" CMOS
Pixel	2M
Resolution	1920×1080
Frame rate	60fps
Output	HDMI
Power supply	220V, 50/60Hz
Dimension (L×W×H)	570×300×430mm
Weight	10kg

STANDARD DELIVERY

Main unit	1 pc
X-Y metal stage	1 pc
16G USB flash disk	1 pc
White/black plate	1 pc
Mouse	1 pc
Power adapter	2 pcs

DIGITAL MEASURING MICROSCOPE (BASIC TYPE) CODE 5318-MD60

POPULAR
MODEL

MEASUREMENT

TAKE
PICTURES

BUILT-IN SOFTWARE
WITHOUT COMPUTER

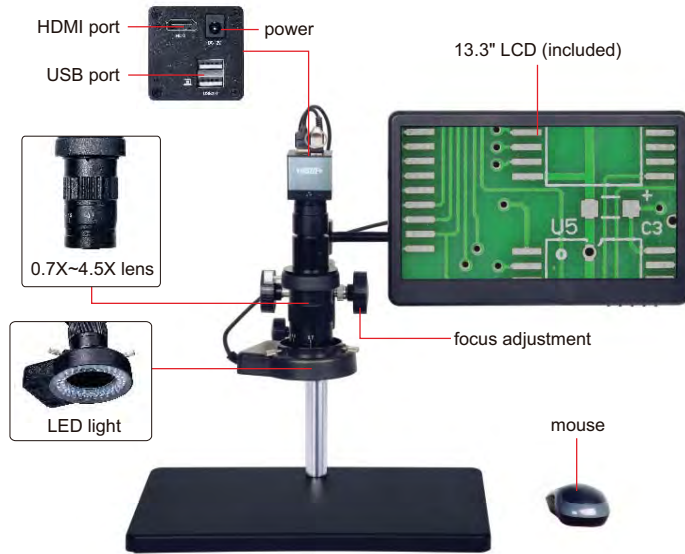

- 1080P high-definition image
- Built-in software without computer, operated by mouse
- Take pictures, save to USB flash disk
- Measurement results can be sent to Excel
- Brightness, contrast ratio, gain are adjustable

SPECIFICATION

Magnification	12.5X~80X
Sensor	1/2.8" CMOS
Pixel	2M
Resolution	1920×1080
Frame rate	60fps
Measuring accuracy	±0.02mm
Lines	cross lines, scale lines (number, color and position of lines are adjustable)
Output	HDMI
Power supply	power adapter
Dimension (L×W×H)	380×260×350mm
Weight	4.5kg



16G USB flash disk (included)



white/black plate (included)

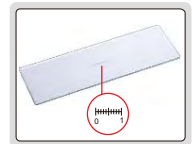

glass calibration rule (graduation 0.1mm, included)

MAGNIFICATION AND VIEWFIELD

Auxiliary objective	Specification	Camera adapter
		0.5X (included)
0.5X (optional)	magnification	6.2~40X
	view field	47×26~7.4×4mm
1X (included)	magnification	12.5~80X
	view field	23.5×13~3.7×2mm
2X (optional)	magnification	25~160X
	view field	11.8×6.5~1.8×1mm

24

STANDARD DELIVERY

Main unit	1 pc
0.5X camera adapter	1 pc
1X auxiliary objective	1 pc
White/black plate	1 pc
Glass calibration rule	1 pc
16G USB flash disk	1 pc
Mouse	1 pc
HDMI cable	1 pc
Power adapter	3 pcs

OPTIONAL ACCESSORY

0.5X auxiliary objective	5318-OB05X
2X auxiliary objective	5318-OB2X

MEASURING SOFTWARE (INCLUDED)

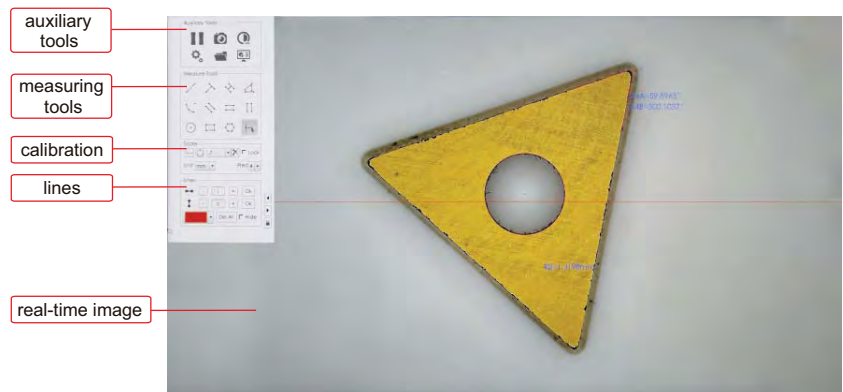

BUILT-IN SOFTWARE
WITHOUT COMPUTER

MEASUREMENT

TAKE
PICTURES

DIGITAL MEASURING MICROSCOPES



0.5X camera adapter
(included)



1X auxiliary objective
(included)



calibration plate
(included)



16G USB flash disk
(included)



1X camera adapter
(optional)



2X auxiliary objective
(optional)

- 1080P high-definition image
- Built-in software without computer, operated by mouse
- Take pictures, save to USB flash disk
- Measurement results can be sent to Excel
- Automatic white balance and exposure
- Brightness, contrast ratio, gain are adjustable

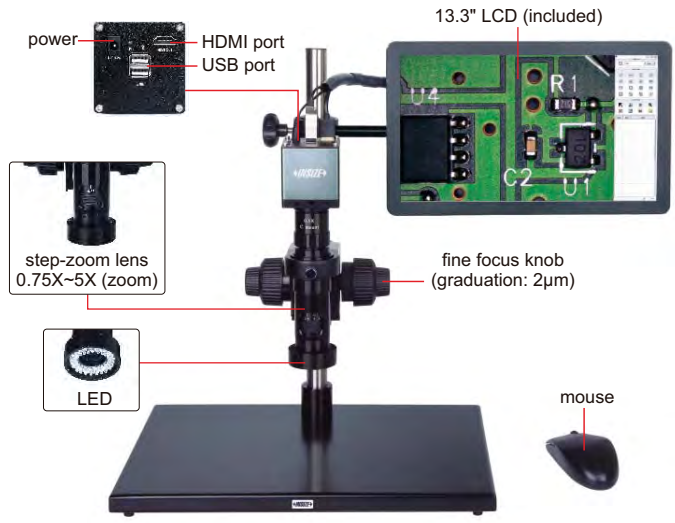

ISM-DL300 (without contour illumination)

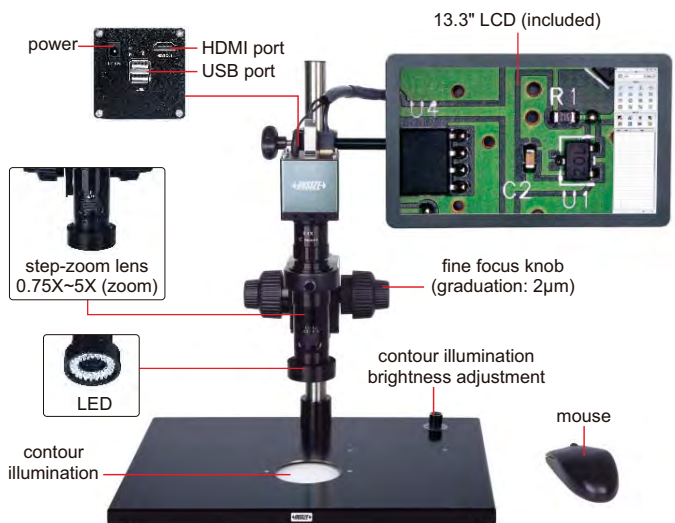

ISM-DL301 (with contour illumination)

SPECIFICATION

Code	ISM-DL300 (without contour illumination)	ISM-DL301 (with contour illumination)
Magnification	15X~100X	
Sensor	1/2" CMOS	
Pixel	2M	
Resolution	1920×1080	
Frame rate	60fps	
Output	HDMI	
Power supply	power adapter	
Dimension (L×W×H)	570×300×430mm	
Weight	6.5kg	

To be continued

Continued from previous page

STANDARD DELIVERY

Code	ISM-DL300	ISM-DL301
Main unit	1 pc	1 pc
0.5X camera adapter	1 pc	1 pc
1X auxiliary objective	1 pc	1 pc
Calibration plate	1 pc	1 pc
16G USB flash disk	1 pc	1 pc
White/black plate	1 pc	1 pc
Mouse	1 pc	1 pc
HDMI cable	1 pc	1 pc
Power adapter	2 pcs	3 pcs

OPTIONAL ACCESSORY

1X camera adapter	ISM-DL-CA1X
2X auxiliary objective	ISM-DL-OB2X
X-Y glass stage (travel: 100×86mm)	ISM-DL-STAGE
X-Y metal stage	ISM-DL-STAGE1
LED light	page 553~554
Auxiliary objective	page 555

MAGNIFICATION AND MEASURING ACCURACY

Objective magnification	Image magnification	Measuring accuracy *
0.75X	15X	±8µm
1X	20X	±7µm
1.5X	30X	±6µm
2X	40X	±6µm
2.5X	50X	±6µm
3X	60X	±5µm
3.5X	70X	±5µm
4X	80X	±4µm
4.5X	90X	±4µm
5X	100X	±4µm

* When measuring the contour of workpieces, please use **ISM-DL301** to ensure accuracy.

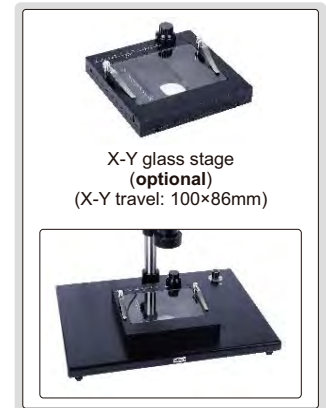

MAGNIFICATION, FOCUS DISTANCE AND VIEW FIELD

Auxiliary objective	Specification	Camera adapter	
		0.5X (included)	1X (optional)
1X (included)	magnification	15~100X	30~200X
	focus distance	70±2mm	70±2mm
	view filed	16×11~2.5×1.6mm	7.8×5.3~1.2×0.8mm
2X (optional)	magnification	30~200X	60~400X
	focus distance	29±2mm	29±2mm
	view filed	7.8×5.3~1.2×0.8mm	3.8×2.7~0.6×0.4mm

SOFTWARE (INCLUDED)

■ Refer to page 550 for details

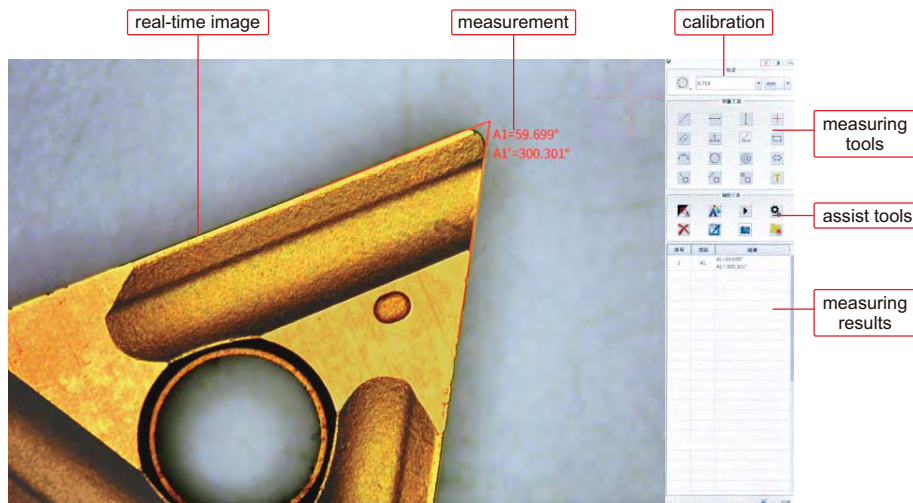

OBSERVATION AND MEASUREMENT
AT HIGH MAGNIFICATION

SOFTWARE IS INCLUDED,
REFER TO PAGE 550 FOR DETAILS

HIGH MAGNIFICATION MEASURING MICROSCOPE CODE ISM-DL302

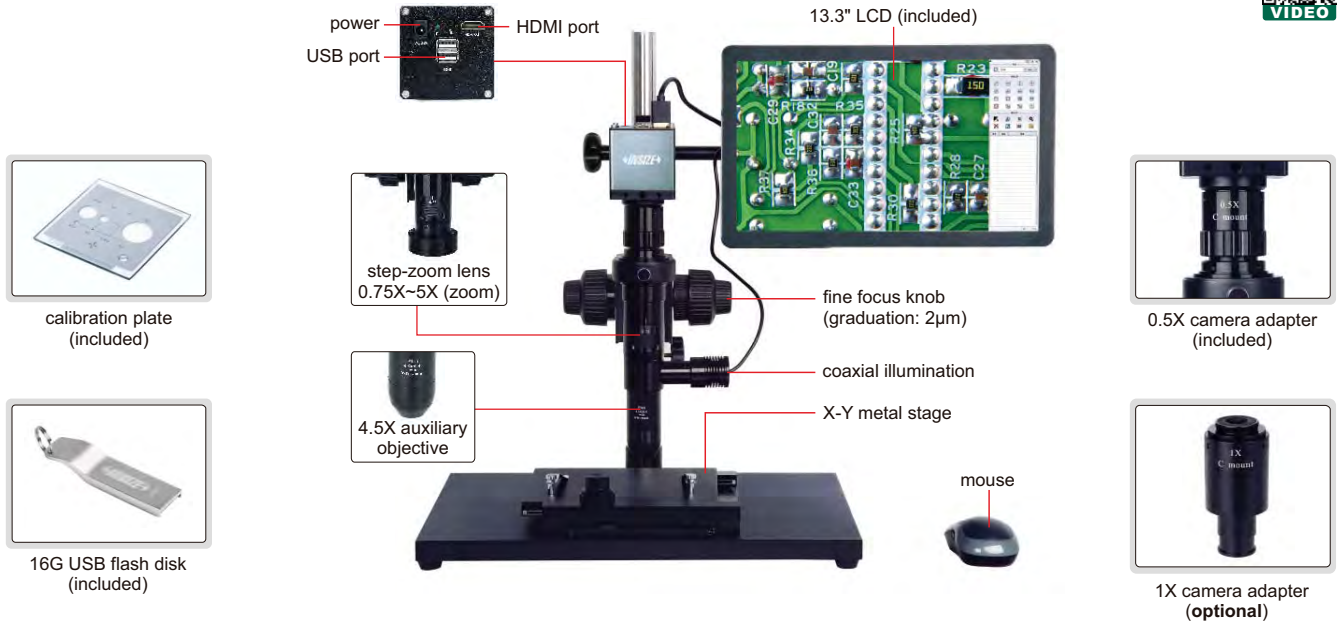

- 1080P high-definition image
- Maximum 1000X optical magnification (using camera adapter 1X, optional)
- Built-in software without computer, operated by mouse
- Solid base and column to avoid lens shaking during focusing
- Software is included, refer to page 550 for details

SPECIFICATION

Magnification	78X~504X
Sensor	1/2" CMOS
Pixel	2M
Resolution	1920×1080
Frame rate	60fps
Output	HDMI
Power supply	power adapter
Dimension (L×W×H)	570×300×430mm
Weight	15kg

SATNDARD DELIVERY

Main unit	1 pc
0.5X camera adapter	1 pc
4.5X auxiliary objective	1 pc
Calibration plate	1 pc
16G USB flash disk	1 pc
Mouse	1 pc
HDMI cable	1 pc
X-Y metal stage	1 pc

OPTIONAL ACCESSORY

1X camera adapter	ISM-DL-CA1X
LED light	page 553~554

MAGNIFICATION AND MEASURING ACCURACY

Objective magnification	Image magnification	Measuring accuracy
0.75X	78X	±5µm
1X	102X	±4µm
1.5X	153X	±4µm
2X	204X	±4µm
2.5X	255X	±4µm
3X	305X	±4µm
3.5X	356X	±4µm
4X	408X	±4µm
4.5X	458X	±4µm
5X	504X	±4µm

MAGNIFICATION, FOCUS DISTANCE AND VIEW FIELD

Camera adapter	0.5X (included)	1X (optional)
Magnification	78~504X	156~1008X
Focus distance	14±2mm	14±2mm
View field	2.8×1.7~0.5×0.3mm	1.4×0.9~0.3×0.2mm

4K DIGITAL MEASURING MICROSCOPE CODE 5310-DL401

BUILT-IN SOFTWARE
WITHOUT COMPUTER

TAKE
PICTURES

MEASUREMENT

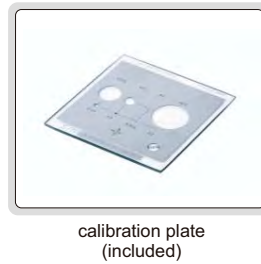
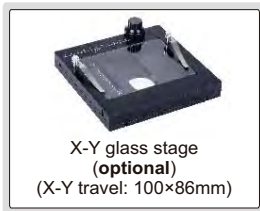
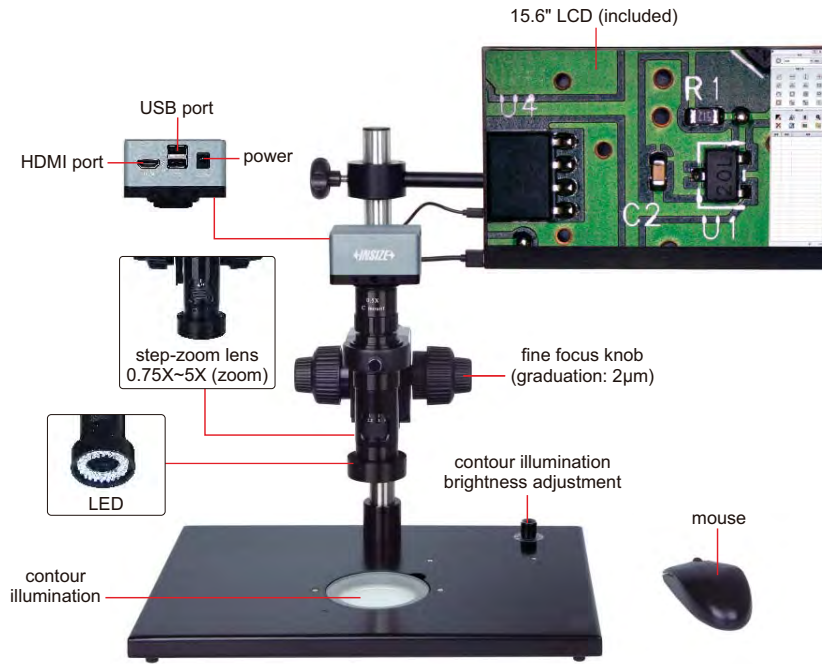

24

- 4K high-definition image
- Built-in software without computer, operated by mouse
- Take pictures, save to USB flash disk
- Measurement results can be sent to Excel
- Automatic white balance and exposure
- Brightness, contrast ratio, gain are adjustable

SPECIFICATION

Magnification	17.6X~120X
Sensor	1/2.3" CMOS
Pixel	8M
Resolution	3840×2160
Frame rate	4K: 30fps, 1080P: 60fps
Output	HDMI
Power supply	power adapter
Dimension (L×W×H)	570×300×430mm
Weight	6.5kg



To be continued

Continued from previous page

MAGNIFICATION, VIEW FIELD AND MEASURING ACCURACY

Objective magnification	Image magnification	View field	Measuring accuracy
0.75X	17.6X	19.5×11.5mm	±5μm
1X	23.7X	14.0×8.0mm	±5μm
1.5X	36.6X	9.0×5.0mm	±5μm
2X	49X	7.0×4.0mm	±5μm
2.5X	62X	5.5×3.0mm	±4μm
3X	73X	4.5×2.5mm	±4μm
3.5X	85X	4.0×2.2mm	±4μm
4X	97X	3.5×2.0mm	±3μm
4.5X	109X	3.0×1.8mm	±3μm
5X	120X	2.7×1.5mm	±3μm

STANDARD DELIVERY

Main unit	1 pc
0.5X camera adapter	1 pc
1X auxiliary objective	1 pc
Calibration plate	1 pc
16G USB flash disk	1 pc
White/black plate	1 pc
Mouse	1 pc
HDMI cable	1 pc
Power adapter	3 pcs

OPTIONAL ACCESSORY

1X camera adapter	ISM-DL-CA1X
2X auxiliary objective	ISM-DL-OB2X
X-Y glass stage (travel: 100×86mm)	ISM-DL-STAGE
X-Y metal stage (travel: 100×86mm)	ISM-DL-STAGE1
LED light	page 553–554
Auxiliary objective	page 555

SOFTWARE (INCLUDED)

- Refer to page 550 for details

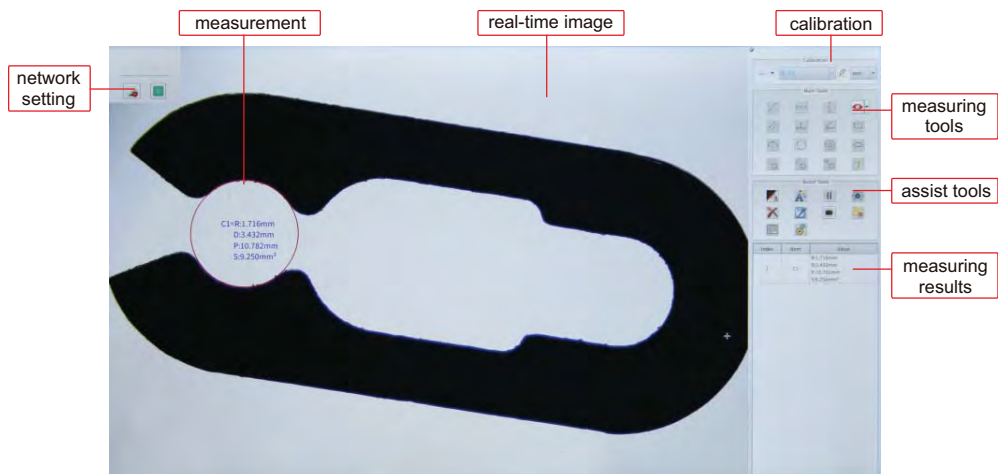

MOTORIZED FOCUS STACKING MICROSCOPE (LARGE DEPTH OF VIEW) CODE ISM-DL520

MOTORIZED FOCUS
STACKING

BUILT-IN SOFTWARE
WITHOUT COMPUTER

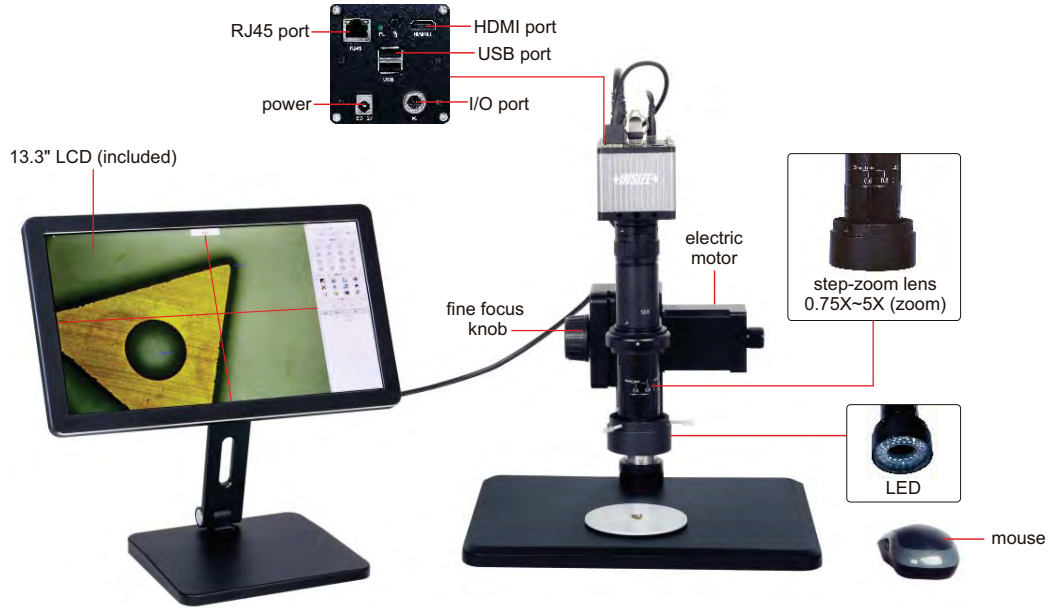

- 1080P high-definition image
- Built-in software without computer, operated by mouse
- Take pictures, save to USB flash disk
- Measurement results can be sent to Excel
- Automatic white balance and exposure
- Motorized focus stacking
- Send photos and measurement data via ethernet (TCP/IP)
- Name photos and measurement data files with serial number of workpieces read by scanner

SPECIFICATION

Magnification	24.5X~204.5X
View field	2.8×1.6~18×10mm
Focus distance	65mm
Sensor	1/1.2" CMOS
Pixel	2M
Resolution	1920×1080
Frame rate	30fps
Output	RJ45
Power supply	power adapter
Dimension (L×W×H)	320×260×500mm
Weight	7kg

focus stacking

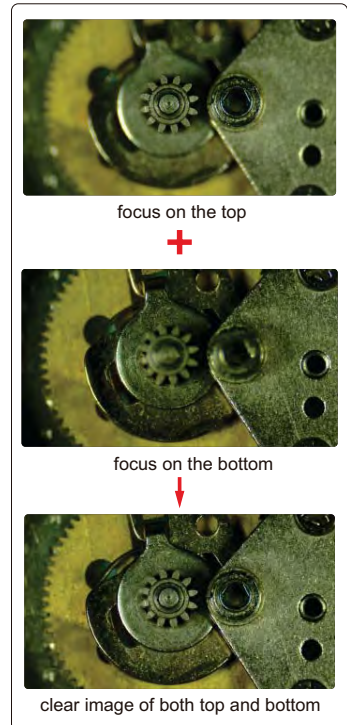

To be continued

Continued from previous page

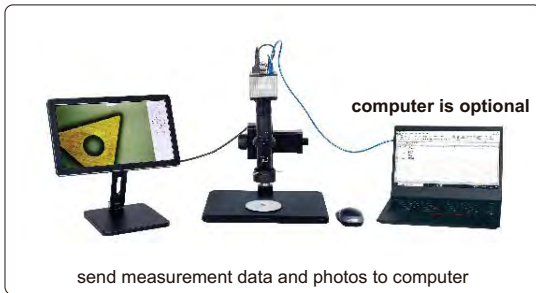

STANDARD DELIVERY

Main unit	1 pc
1X camera adapter	1 pc
1X auxiliary objective	1 pc
Calibration plate	1 pc
16G USB flash disk	1 pc
Mouse	1 pc
LED ring light	1 pc
White/black plate	1 pc
Power adapter	3 pcs

MAGNIFICATION AND MEASURING ACCURACY

Objective magnification	Image magnification	Measuring accuracy
0.6X	24.5X	±8μm
0.8X	32.7X	±7μm
1X	40.9X	±6μm
1.5X	61.3X	±6μm
2X	81.8X	±6μm
2.5X	102.2X	±5μm
3X	122.7X	±5μm
3.5X	143.1X	±4μm
4X	163.6X	±4μm
4.5X	184.0X	±4μm
5X	204.5X	±4μm



OPTIONAL ACCESSORY

X-Y metal stage (travel: 100×86mm)	ISM-DL-STAGE1
------------------------------------	---------------

SOFTWARE (INCLUDED)

- Refer to page 550 for details

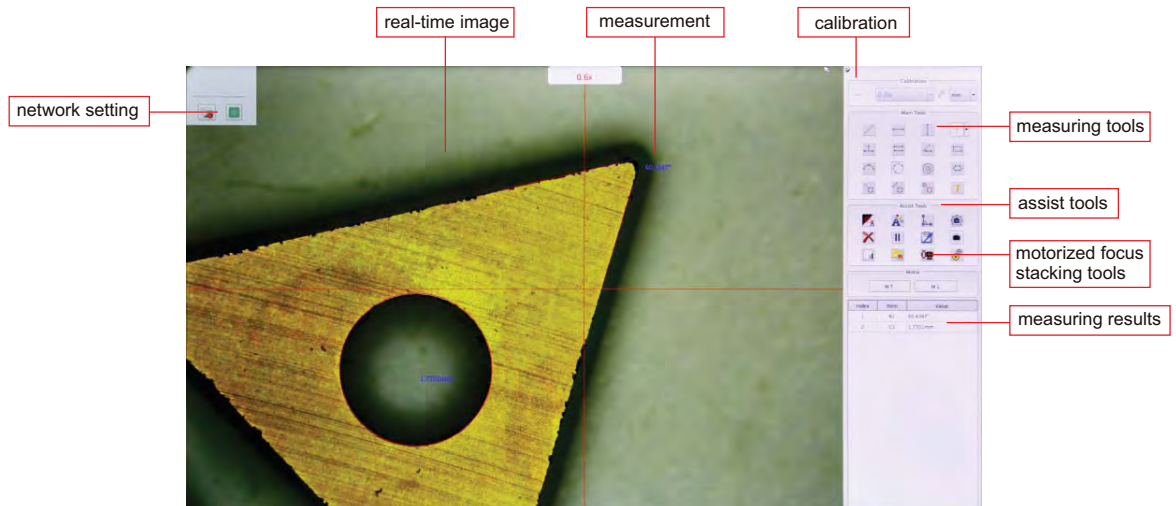

MANUAL FOCUS STACKING MICROSCOPE (LARGE DEPTH OF VIEW) CODE ISM-DL510

BUILT-IN SOFTWARE
WITHOUT COMPUTER

FOCUS
STACKING

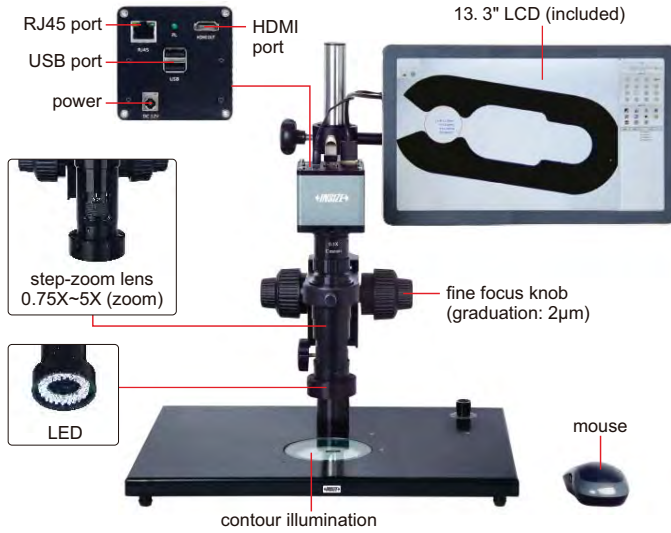

- 1080P high-definition image
- Built-in software without computer, operated by mouse
- Take pictures, save to USB flash disk
- Measurement results can be sent to Excel
- Automatic white balance and exposure
- Focus stacking
- Send photos and measurement data via ethernet (TCP/IP)
- Name photos and measurement data files with serial number of workpieces read by scanner

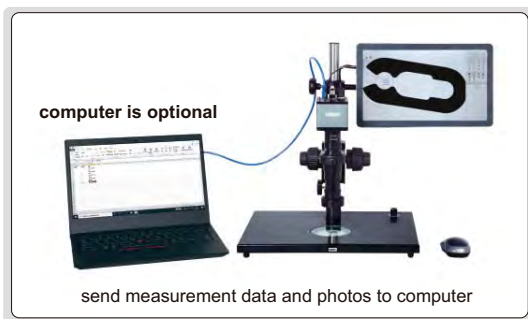
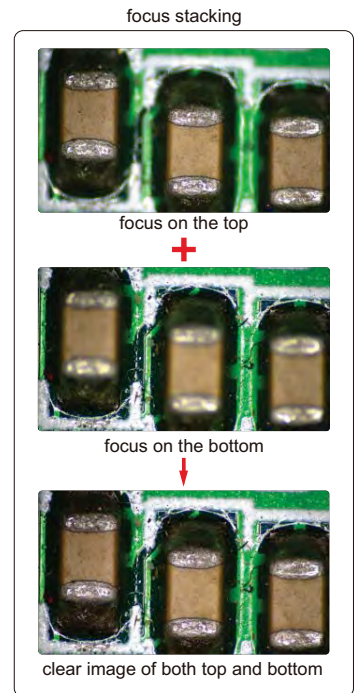

SPECIFICATION

Magnification	15X~100X
Sensor	1/2" CMOS
Pixel	2M
Resolution	1920×1080
Frame rate	60fps
Output	HDMI
Power supply	power adapter
Dimension (L×W×H)	570×300×430mm

To be continued

Continued from previous page

STANDARD DELIVERY

Main unit	1 pc
0.5X camera adapter	1 pc
1X auxiliary objective	1 pc
Calibration plate	1 pc
16G USB flash disk	1 pc
White/black plate	1 pc
Mouse	1 pc
Power adapter	3 pcs

OPTIONAL ACCESSORY

1X camera adapter	ISM-DL-CA1X
2X auxiliary objective	ISM-DL-OB2X
X-Y glass stage (travel: 100×86mm)	ISM-DL-STAGE
Scanner and hub	7328-SCAN
LED light	page 553~554
Auxiliary objective	page 555

MAGNIFICATION AND MEASURING ACCURACY

Objective magnification	Image magnification	Measuring accuracy
0.75X	15X	±8µm
1X	20X	±7µm
1.5X	30X	±6µm
2X	40X	±6µm
2.5X	50X	±6µm
3X	60X	±5µm
3.5X	70X	±5µm
4X	80X	±4µm
4.5X	90X	±4µm
5X	100X	±4µm

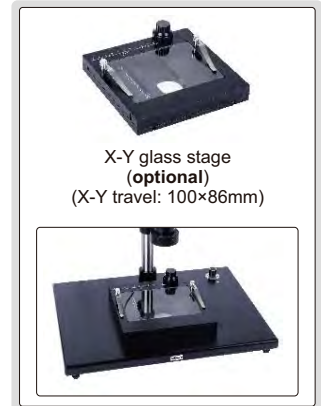

MAGNIFICATION, FOCUS DISTANCE AND VIEW FIELD

Auxiliary objective	Specification	Camera adapter	
		0.5X (included)	1X (optional)
1X (included)	magnification	15~100X	30~200X
	focus distance	70±2mm	70±2mm
	view filed	16×11~2.5×1.6mm	7.8×5.3~1.2×0.8mm
2X (optional)	magnification	30~200X	60~400X
	focus distance	29±2mm	29±2mm
	view filed	7.8×5.3~1.2×0.8mm	3.8×2.7~0.6×0.4mm

SOFTWARE (INCLUDED)

- Refer to page 550 for details

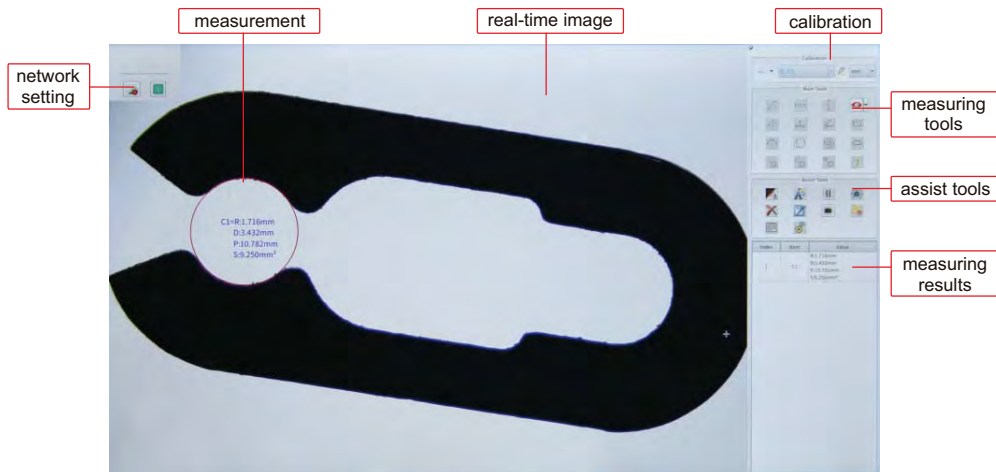

HORIZONTAL MICROSCOPE CODE 5316-HM810

BUILT-IN SOFTWARE
WITHOUT COMPUTER

TAKE
PICTURES

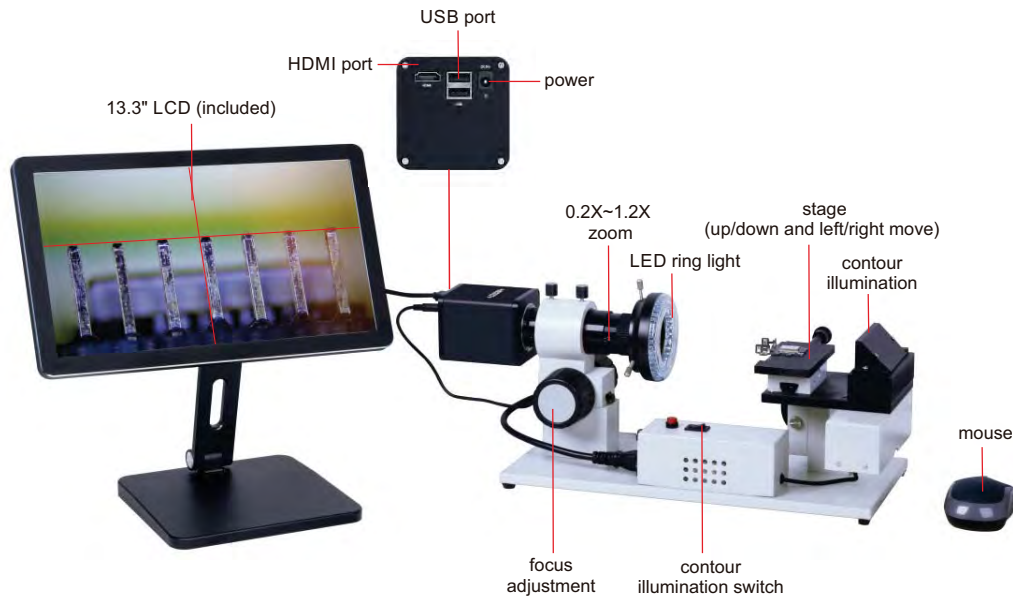

- 1080P high-definition image
- Built-in software without computer, operated by mouse
- Take pictures, save to USB flash disk
- Automatic white balance and exposure
- Brightness, contrast ratio, gain are adjustable
- Display cross hair (blue/green/red/yellow/black/brown colors)



plastic calibration rule
(included, graduation 1mm)



16G USB flash disk
(included)

SPECIFICATION

Magnification	10.5X~62.5X
View field	4.5×2.5~28×12.3mm
Focus distance	115mm
Measuring accuracy	±0.02mm
Sensor	1/2.8" CMOS
Pixel	2M
Resolution	1920×1080
Frame rate	1080P: 60fps/50fps
Output	HDMI
Power supply	110/220V, 50/60Hz
Dimension (L×W×H)	500×200×200mm
Weight	7kg

STANDARD DELIVERY

Main unit	1 pc
1X camera adapter	1 pc
1X auxiliary adapter	1 pc
Plastic calibration rule	1 pc
16G USB flash disk	1 pc
Mouse	1 pc
LED ring light	1 pc

SOFTWARE (INCLUDED)

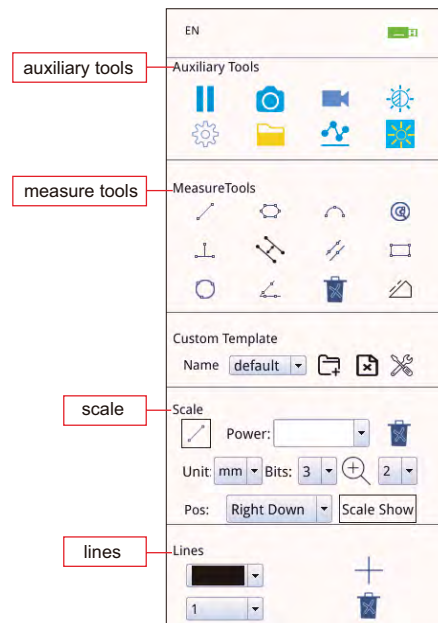

AUTO FOCUS

TAKE PICTURES AND VIDEOS

MEASUREMENT



FLEXIBLE ARM AUTO FOCUS DIGITAL MICROSCOPES

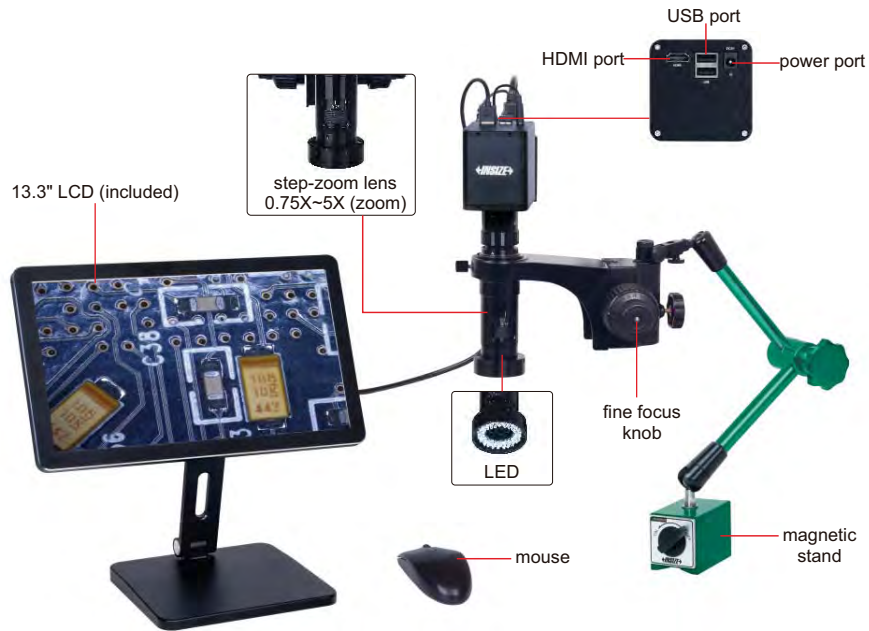

5317-AF109

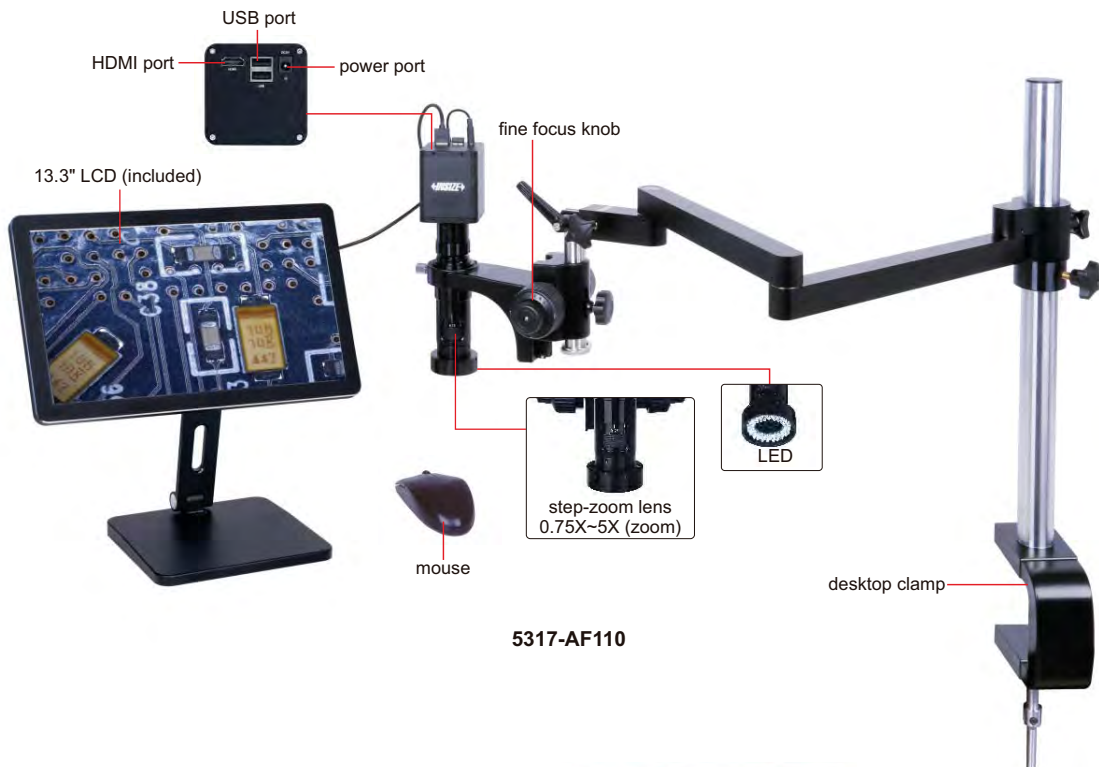

5317-AF110

- 1080P high-definition image
- Auto focus camera
- Take pictures and videos, saved to USB flash disk
- Picture review, picture compare
- Automatic exposure and white balance
- Brightness, contrast ratio, gain are adjustable
- Display cross hair (blue/green/red/yellow/black/brown colors)
- Built-in software without computer, operation by mouse
- Flexible arm

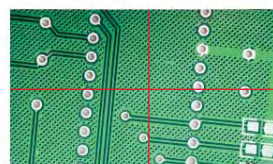

display cross hair (blue/green/red/yellow/black/brown colors)

To be continued

Continued from previous page

SPECIFICATION

Code	5317-AF109 (with magnetic stand)	5317-AF110 (with desktop clamp)
Magnification	20X~123X	
Sensor	1/2.8" CMOS	
Pixel	2M	
Resolution	1920×1080	
Frame rate	60fps	
Power supply	power adapter	
Dimension (height)	480mm	600mm
Weight	5.6kg	8.5kg



calibration plate
(included)



16G USB flash disk
(included)



0.5X camera adapter
(included)



1X auxiliary objective
(included)

MAGNIFICATION, FOCUS DISTANCE AND VIEW FIELD

Auxiliary objective	Specification	Camera adapter	
		0.5X (included)	1X (optional)
1X (included)	magnification	20~123X	40~246X
	focus distance	48~84mm	48~84mm
	view field	13×7~2.2×1mm	6.3×3.5~1.1×0.5mm
	measuring accuracy	±0.02mm	±0.02mm
2X (optional)	magnification	40~246X	80~492X
	focus distance	24~42mm	24~42mm
	view field	6.5×3.5~1.1×0.5mm	3.3×1.8~0.6×0.3mm
	measuring accuracy	±0.02mm	±0.02mm

STANDARD DELIVERY

Main unit	1 pc
0.5X camera adapter	1 pc
1X auxiliary objective	1 pc
Calibration plate	1 pc
16G USB flash disk	1 pc
White/black plate	1 pc
Mouse	1 pc
HDMI cable	1 pc
Power adapter	2 pcs

AUTO FOCUS DISTANCE

Zoom objective scale	0.75X	1X	1.5X	2X	2.5X
Auto focus distance	48~84mm	50~78mm	55~73mm	62~71mm	65~70mm

Zoom objective scale	3X	3.5X	4X	4.5X	5X
Auto focus distance	66~70mm	67~70mm	68~70mm	68~70mm	68~70mm

OPTIONAL ACCESSORY

1X camera adapter	ISM-DL-CA1X
2X auxiliary objective	ISM-DL-OB2X
Auxiliary objective	page 555

MEASURING SOFTWARE (INCLUDED)

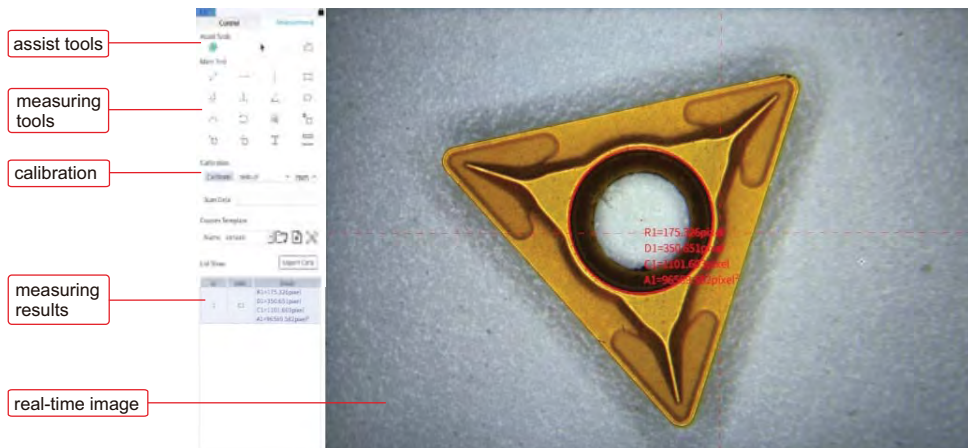

**ELECTRONIC MAGNIFICATION
FEEDBACK LENS**

**BUILT-IN SOFTWARE
WITHOUT COMPUTER**

DIGITAL MEASURING MICROSCOPE CODE 5307-ID100A



- Electronic magnification feedback lens: when the objective lens magnification is changed manually, the software automatically selects the corresponding pre-calibration data and calibration is not needed
- Two methods of LED brightness adjustment, knob adjustment and software adjustment
- Built-in software without computer, operated by mouse
- Take pictures, save to USB flash disk
- Measuring results can be sent to Excel

adjustable display angle



LED ring light
1X auxiliary objective

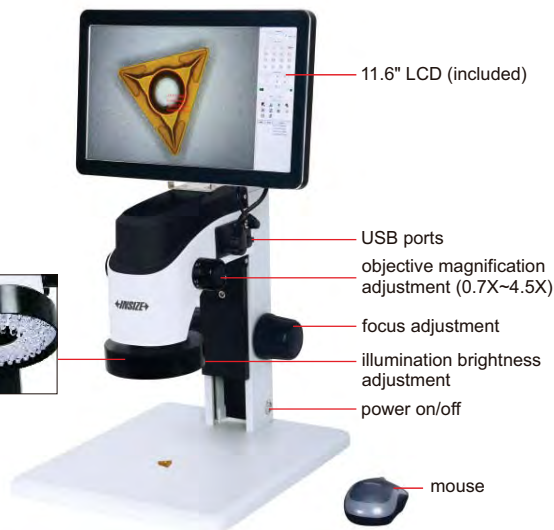

11.6" LCD (included)

USB ports
objective magnification adjustment (0.7X~4.5X)
focus adjustment
illumination brightness adjustment
power on/off

mouse

SPECIFICATION

Sensor	1/2" CMOS
Pixel	2M
Resolution	1920×1080
Magnification	12~77X
Focus distance	100mm
View field	2.7×1.9~17.5×11.9mm
Max workpiece height	60mm
Frame rate	60fps
Output	USB/HDMI
Power supply	power adapter
Dimension (L×W×H)	610×610×660mm
Weight	4.5kg

STANDARD DELIVERY

Main unit	1 pc
Calibration plate	1 pc
Power adapter	1 pc
Mouse	1 pc
16G USB flash disk	1 pc

MAGNIFICATION AND MEASURING ACCURACY

Objective magnification	Magnification	Measuring accuracy
0.7X	12X	±9µm
1X	17X	±9µm
1.5X	26X	±8µm
2X	35X	±7µm
2.5X	43X	±7µm
3X	51X	±7µm
3.5X	60X	±6µm
4X	68X	±6µm
4.5X	77X	±5µm

OPTIONAL ACCESSORY

0.5X auxiliary objective	5307-ID100A-OB05X
0.75X auxiliary objective	5307-ID100A-OB075X
2X auxiliary objective	5307-ID100A-OB2X

SOFTWARE (INCLUDED)

- Refer to page 550 for details

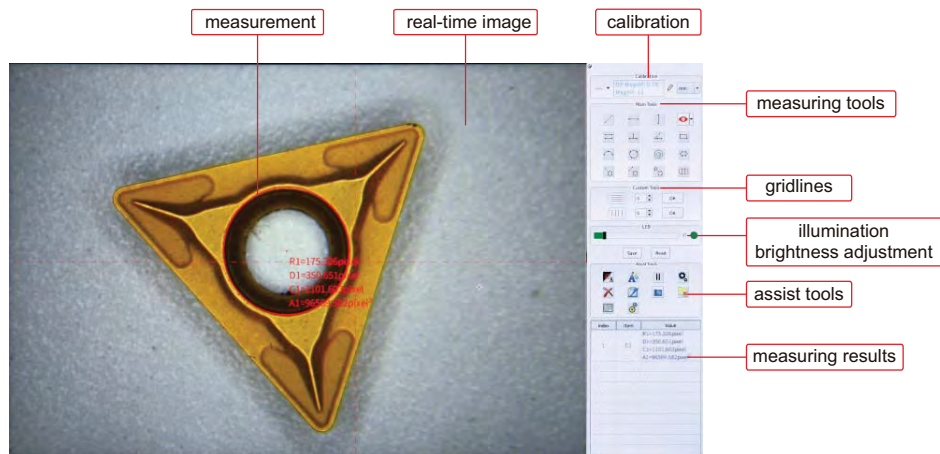

measurement

real-time image

calibration

measuring tools

gridlines

illumination brightness adjustment

assist tools

measuring results

AUTO FOCUS DIGITAL MICROSCOPE CODE 5319-AF290

NO CALIBRATION
AFTER ZOOM

AUTO FOCUS

TAKE PICTURES
AND VIDEOS

MEASUREMENT

MOTORIZED
LIGHT CONTROL

MOTORIZED
ZOOM



- Auto focus camera
- Take pictures and videos
- Built-in measuring software
- Automatic exposure and white balance
- Brightness, contrast ratio, gain are adjustable
- Display actual magnification
- Digital magnification
- Shortcut keyboard operation
- Display cross hair and gridline (blue/green/red/yellow/black/white colors)

SPECIFICATION

Magnification	27.4X~163X
Sensor	1/2.8" CMOS
Pixel	2M
Measuring accuracy	±0.02mm
Resolution	1920×1080
Frame rate	50/60fps
Output	HDMI
Power supply	power adapter
Dimension (L×W×H)	600×280×390mm
Weight	6.5kg

STANDARD DELIVERY

Main unit (with stand)	1 pc
21.5" LCD	1 pc
16G USB flash disk	1 pc
Mouse	1 pc
HDMI cable	1 pc
Calibration plate	1 pc
White/black plate	1 pc
Shortcut keyboard	1 pc
Power adapter	2 pcs

FOCUS DISTANCE AND VIEW FIELD

Optical magnification*	0.8X	1X	2X	3X	4X	4.76X
Focus distance	88~133mm	88~133mm	98~123mm	103~115mm	108~111mm	108~111mm
View field (mm)	19.4×11~15.8×8.8	15×8.3~12.7×7.2	7.1×4~6.7×3.8	4.8×2.7~4.5×2.5	3.6×2~3.3×1.8	3×1.7~2.8×1.6

* The optical zoom lens can be arbitrarily zoomed between 0.8X and 4.76X



Shortcut keyboard function

- Take picture: take a picture and save it
- Video: record a video
- Freeze: the image can be frozen
- Manual focus-: reduce the manual focus value
- Manual focus+: increase the manual focus value
- Zoom+: increase the magnification
- Zoom-: reduce the magnification
- AF/MF: switch to auto focus or manual focus
- FBL: center the camera motor
- Mirror: image horizontal flipover
- Flip: image vertical flipover
- Focus: achieve one-key focus
- Zoom 1, 2, 3, 4: save the current magnification
- Brightness+: increase the brightness of the light
- Brightness-: reduce the brightness of the light

SOFTWARE (INCLUDED)

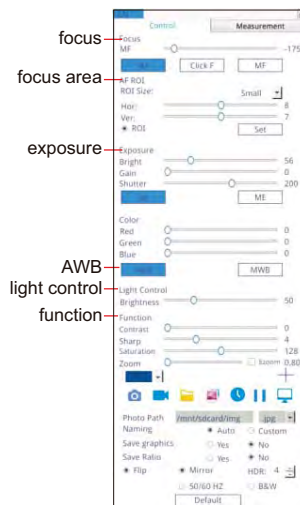

BUILT-IN SOFTWARE
WITHOUT COMPUTER

SPLIT SCREEN
DESIGN

TAKE PICTURES
AND VIDEOS

CUTTING TOOLS MICROSCOPE CODE ISM-CT820

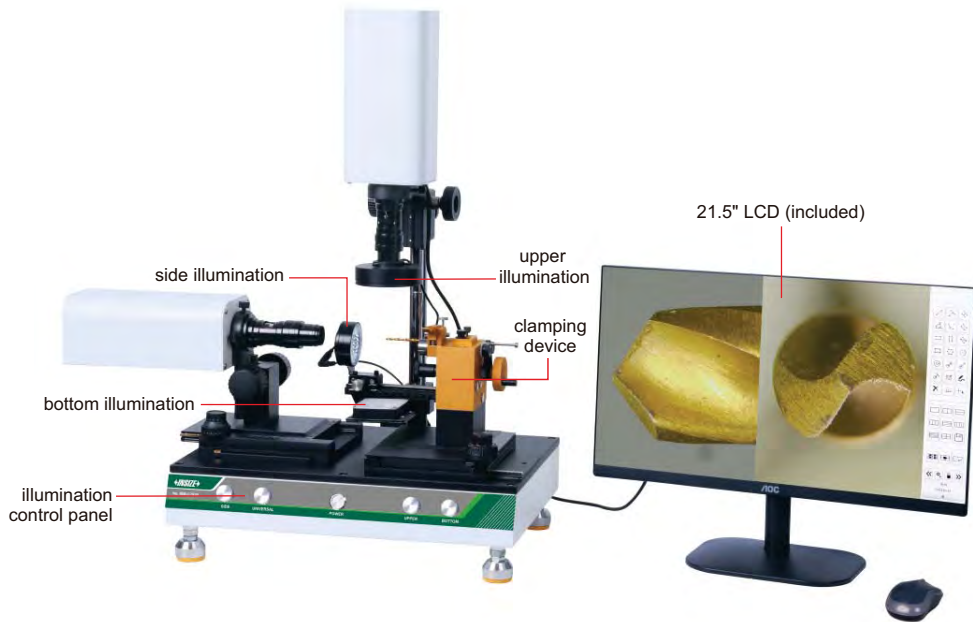

glass calibration plate (included)

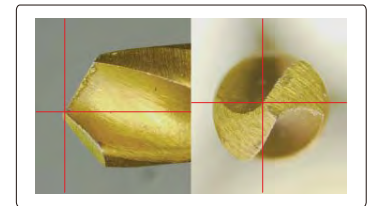

display cross hairs separately (movable)

- Split screen design, zoom in and out independently
- One mouse can operate two cameras
- Display cross hairs
- Brightness, contrast ratio, white balance are adjustable
- Basic measuring tools including point to point, point to line, line to line, angle, three-point circle, etc.

SPECIFICATION

Cutting tools range	Ø3~10mm, length 30-75mm
Lens	step-zoom lens
Output	HDMI
Resolution	1920×1080
Frame rate	60fps
Focus distance	85mm
View field	0.9×1.5~5.5×10mm
Magnification	45-290X
Power supply	AC 100-240V
Dimension (L×W×H)	450×300×700mm
Weight	20kg

STANDARD DELIVERY

Main unit	1 pc
Display	1 pc
32G USB flash disk	1 pc
Mouse	1 pc
HDMI cable	1 pc
Glass calibration plate	1 pc
Anti-dust cover	1 pc

SOFTWARE (INCLUDED)

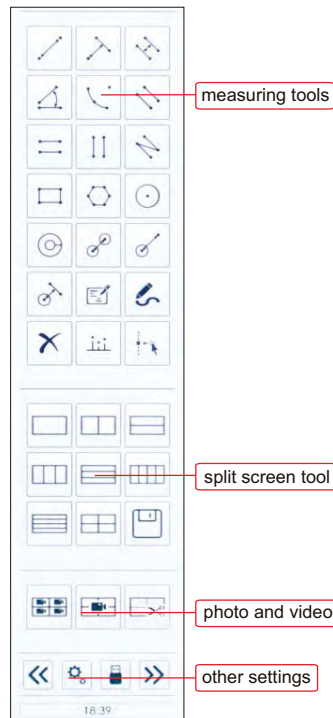

screen display

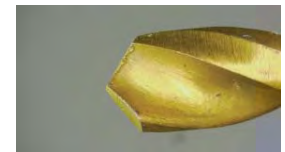

single screen display

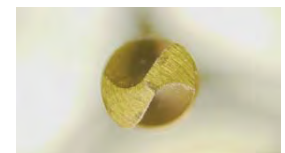

single screen display

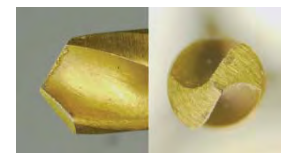

split screen display

MEASURING SOFTWARE OF DIGITAL MICROSCOPES

SOFTWARE CAN BE CUSTOMIZED

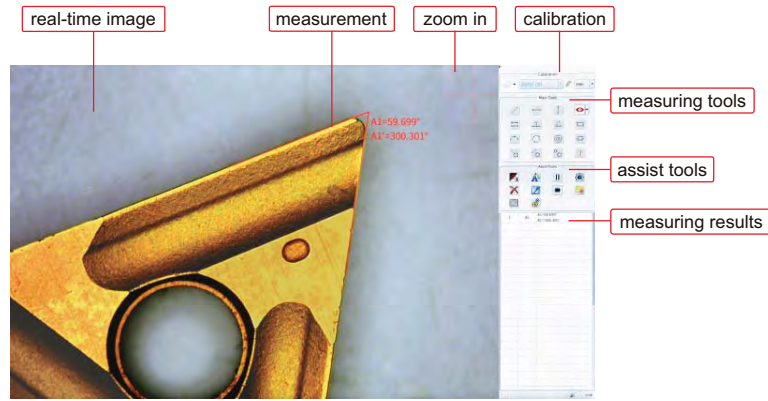

- **Included in digital microscopes (ISM-DL300, ISM-DL301, 5310-DL401, ISM-DL302, ISM-DL510, ISM-DL520, 5307-ID100A)**
- **Language:** Simplified Chinese, Traditional Chinese, English, Korean
- **Calibration:**

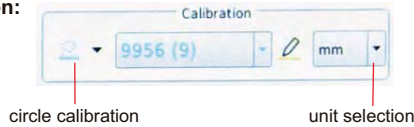

Edge-detection:

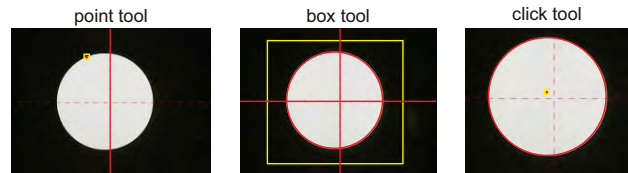

Measurement tools:

- | | | |
|--|---|---|
| measure length of line or distance between two points | measure length of line or distance between two points in horizontal direction | measure length of line or distance between two points in vertical direction |
| measure angle from horizontal line | measure angle from vertical line | measure angle of two lines |
| measure distance between two parallel lines | measure distance between two parallel lines | measure distance between multiple parallel lines |
| measure distance between point and line | measure radius, length and angle of arc | measure girth and area of polygon |
| measure radius, diameter, girth and area of circle with three points | measure radius, diameter, girth and area concentric of circles | measure length, width, girth and area of rectangle |
| measure minimum distance between point and circle | measure distance between point and center of circle | measure maximum distance between point and circle |
| measure minimum distance between line and circle | measure distance between line and center of circle | measure maximum distance between line and circle |
| measure minimum distance between two circles | measure center distance between two circles | measure maximum distance between two circles |
| add text | measure radius, diameter, girth and area of circle with two points | cross hair and graduated cross hair |

Assist tools:

- | | |
|--------------------------------------|-----------------------------------|
| manual/automatic point selection | delete images |
| line width and color settings | export measurement data to U disk |
| freeze screen | take pictures and save |
| camera parameter settings | review pictures |
| layout settings of measurement items | system settings |

Cross hair:

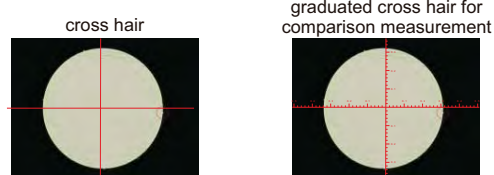

Grid comparison measurement:

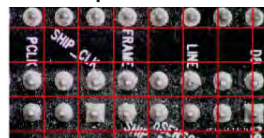

full-screen grid for comparison measurement, adjustable grid number

Output to Excel:

1	A1	A1=59.699°
		A1=300.301°

Comparison:

set the standard workpiece as the background image, superimpose the measured workpieces on the image for quick comparison

**AUTOMATICALLY LOCATE WORKPIECES
REGARDLESS OF POSITION AND DIRECTION**

**BUILT-IN SOFTWARE
WITHOUT COMPUTER**

SMART MICROSCOPE CODE ISM-DL400

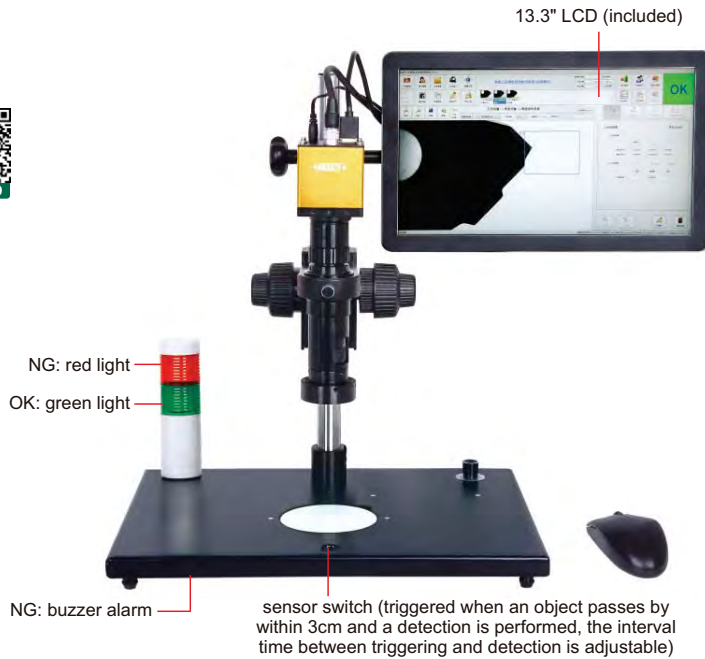

camera function

- surface defect detection
- dimension measurement
- read barcode
- burr detection
- contour matching
- character recognition
- color detection
- read QR code
- object counting
- thread measurement

detect different workpieces at one time

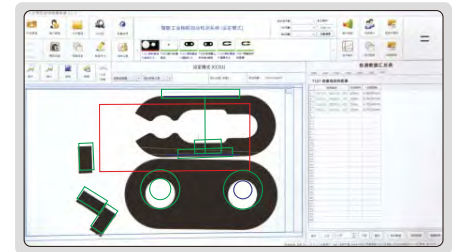

- Automatically identify different workpieces
- Automatically locate workpieces regardless of position and direction
- Built-in software, PLC control input and output interface
- Including multiple detection tools
- Automatically calculate, store the test results and sent to Excel

report showing the perform times of each tool, quantity of OK and NG, the report can be saved

report of each detection is automatically created and saved

SPECIFICATION

Magnification	15X~100X
Resolution	1920×1080
Pixel	2M
Single pixel size	3.75×3.75µm
Frame rate	60fps
Sensor	1/2" CMOS
Chip structure	FPGA+ARM
Operation system	Linux 3.10
Power supply	power adapter
Dimension (L×W×H)	570×300×430mm
Weight	6.5kg

STANDARD DELIVERY

Main unit	1 pc
0.5X camera adapter	1 pc
1X auxiliary objective	1 pc
Calibration plate	1 pc
16G USB flash disk	1 pc
White/black plate	1 pc
HDMI cable	1 pc
Power adapter	3 pcs

MAGNIFICATION, FOCUS DISTANCE AND VIEW FIELD

Auxiliary objective	Specification	Camera adapter	
		0.5X (included)	1X (optional)
1X (included)	magnification	15~100X	30~200X
	focus distance	70±2mm	70±2mm
	view filed	16×11~2.5×1.6mm	7.8×5.3~1.2×0.8mm
2X (optional)	magnification	30~200X	60~400X
	focus distance	29±2mm	29±2mm
	view filed	7.8×5.3~1.2×0.8mm	3.8×2.7~0.6×0.4mm

OPTIONAL ACCESSORY

1X camera adapter	ISM-DL-CA1X
2X auxiliary objective	ISM-DL-OB2X
LED light	page 553~554
Auxiliary objective	page 555

To be continued

Continued from previous page

■ APPLICATION EXAMPLES:

dimension measurement

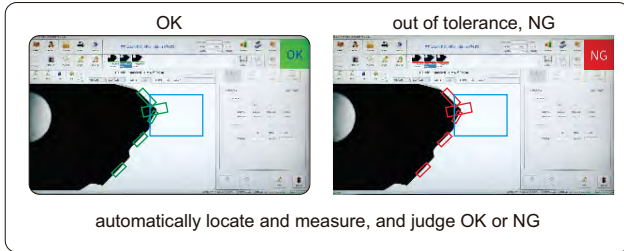

thread measurement

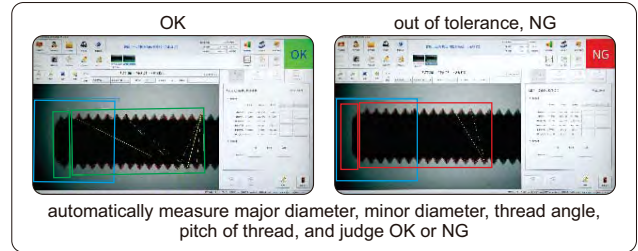

cutting tools measurement

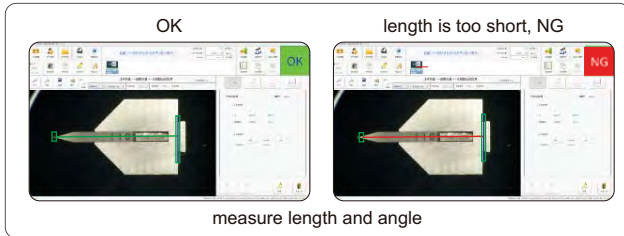

counting

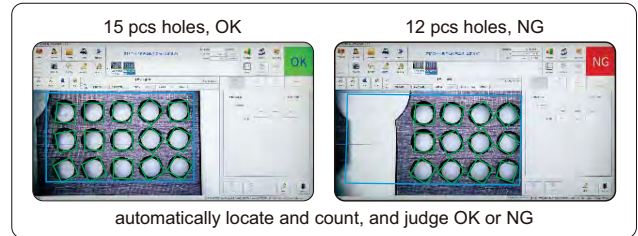

existence or absence

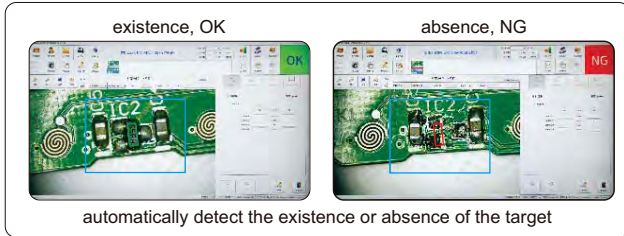

character recognition

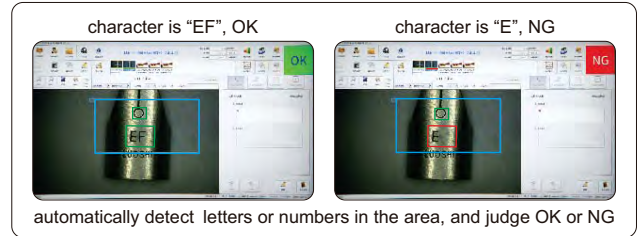

color detection

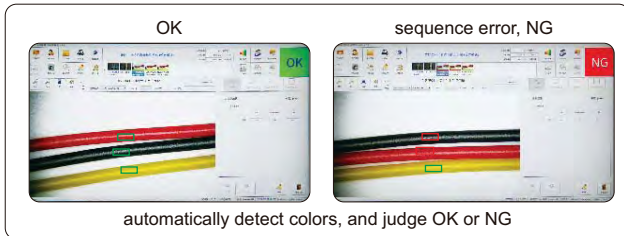

location detection

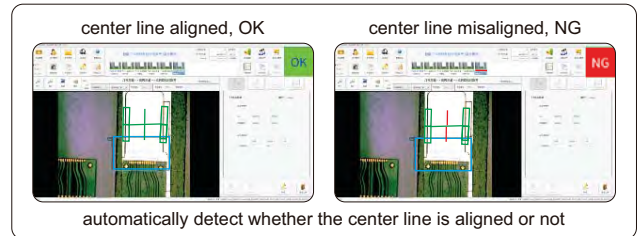

surface defect detection

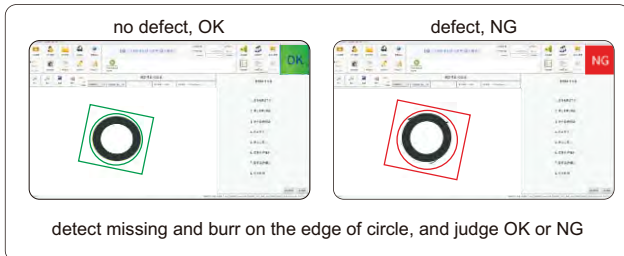

glue detection

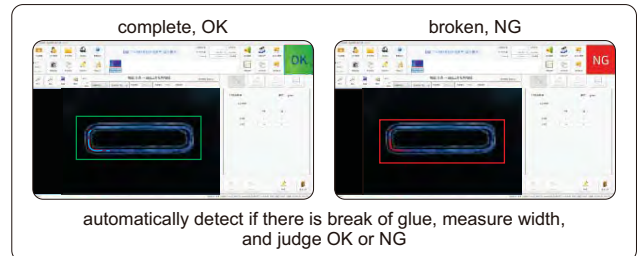

X-Y METAL STAGE CODE ISM-DL-STAGE1

- Suitable for digital microscopes 5315-S710, 5301-D400, 5313-S407, 5310-DL401, 5303-AF103, ISM-DL300, ISM-DL301, ISM-DL302, ISM-DL520

SPECIFICATION

X-Y travel range	100×86mm
Dimension (L×W×H)	180×180×50mm
Weight	2.3kg



RED, GREEN, BLUE, INFRARED AND UV LIGHT CAN BE CUSTOMIZED

ATTENTION: MUST BE USED WITH LIGHT BRACKET AND LIGHT CONTROLLER

LED RING LIGHT CODE ISM-LED-9245R

- Diffuser plate is included to reduce the reflective effect on workpieces
- Suitable for digital microscopes 5303-AF103, 5310-DL401, ISM-DL300, ISM-DL301, ISM-DL302, ISM-DL400, ISM-DL510, 5315-S710

SPECIFICATION

Light color	white
Power supply	24V
Power	5.5W
Angle	45°
Outside/inside diameter	92/52mm



RED, GREEN, BLUE, INFRARED AND UV LIGHT CAN BE CUSTOMIZED

ATTENTION: MUST BE USED WITH LIGHT BRACKET AND LIGHT CONTROLLER

LED SQUARE LIGHT CODE ISM-LED-100L4

- Diffuser plate is included to reduce the reflective effect on workpieces
- Angle and brightness can be adjusted independently
- Suitable for digital microscopes 5303-AF103, 5310-DL401, ISM-DL300, ISM-DL301, ISM-DL302, ISM-DL400, ISM-DL510, 5315-S710

SPECIFICATION

Light color	white
Power supply	24V
Power	10.36W
Angle	0~90°
Dimension (L×W×H)	154×154×30mm

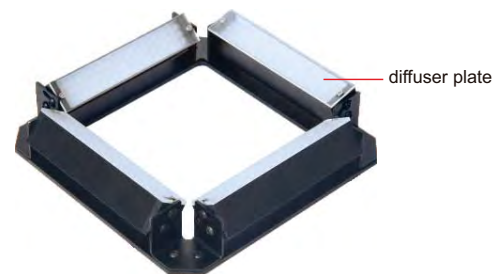

DIGITAL LIGHT CONTROLLER CODE ISM-LED-CTRL

- 256 (0-255) steps of brightness adjustment
- With power off memory function and short circuit protection function
- Suitable for ISM-LED-100L4, ISM-LED-9245R

SPECIFICATION

Power supply	100~240V, 50/60HZ
Output power (rated)	60W
Output voltage (rated)	24V
Dimension (L×W×H)	145×118×83mm

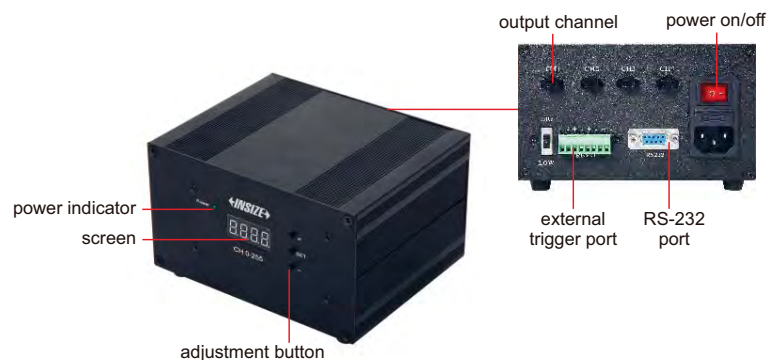

BRACKET FOR LIGHTS CODE ISM-LED-BRACKET



- 4 pcs L-shape bars are included, multiple combinations can be realized
- Suitable for ISM-LED-100L4, ISM-LED-9245R

application



SPECIFICATION

Size (L×W×H)	260×300×20mm
Weight	0.7kg

DUAL HEAD LED LIGHT CODE ISM-ZS-LED

- Adjustable illumination
- For digital and stereo microscopes

SPECIFICATION

Power	3W
Power supply	100~240V
Working	10000h
Illumination	10000lux



application



LED AUXILIARY LIGHT CODE ISM-DL-LED

- Suitable for digital microscopes
5303-AF103, 5310-DL401, ISM-DL300,
ISM-DL301, ISM-DL302, ISM-DL400,
ISM-DL510, 5315-S710



SPECIFICATION

Power	8W
Diameter of mounting hole	Ø25mm
Power supply	10~12V, 0~300mA



illumination direction and brightness are adjustable

COAXIAL LIGHT CODE ISM-DL-COAXIAL

- Suitable for digital microscopes
5303-AF103, 5310-DL401, ISM-DL300,
ISM-DL301, ISM-DL302, ISM-DL400,
ISM-DL510, 5315-S710



SPECIFICATION

Power	1W
Power supply	0~3.4V, 0~400mA



for smooth surfaces and small holes, brightness is adjustable



AUXILIARY OBJECTIVES



0.3X auxiliary objective*
ISM-DL-OB03X



0.5X auxiliary objective*
ISM-DL-OB05X



0.75X auxiliary objective*
ISM-DL-OB075X



1X auxiliary objective
ISM-DL-OB1X



1.5X auxiliary objective
ISM-DL-OB1D5X



2X auxiliary objective
ISM-DL-OB2X

- Suitable for digital microscopes 5303-AF103, 5310-DL401, ISM-DL300, ISM-DL301, ISM-DL302, ISM-DL400, ISM-DL510, 5315-S710, 5317-AF109, 5317-AF110

MAGNIFICATION, FOCUS DISTANCE AND VIEW FIELD (5303-AF103)

Auxiliary objective	Specification	Camera adapter	
		0.5X (included)	1X (optional)
0.3X (optional)	magnification	6~37X	12~74X
	focus distance	120~310mm	120~310mm
	view field	52×30~8×5mm	26×15~4×2.5mm
0.5X (optional)	magnification	10~61X	20~123X
	focus distance	78~230mm	78~230mm
	view field	37×20~5×3mm	18×10~2.5×1.5mm
0.75X (optional)	magnification	15~92X	30~184X
	focus distance	60~125mm	60~125mm
	view field	21×13~3.4×2mm	10×6.5~1.7×1mm
1X (included)	magnification	20~123X	40~246X
	focus distance	48~84mm	48~84mm
	view field	15×8~2.5×1.5mm	7.5×4~1.3×0.7mm
1.5X (optional)	magnification	30~184X	60~368X
	focus distance	36~63mm	36~63mm
	view field	10×6~1.7×1mm	5×3~0.9×0.5mm
2X (optional)	magnification	40~246X	80~492X
	focus distance	24~42mm	24~42mm
	view field	7.5×4~1.3×0.7mm	3.8×2~0.7×0.4mm

MAGNIFICATION, FOCUS DISTANCE AND VIEW FIELD (ISM-DL300, ISM-DL301, ISM-DL510)

Auxiliary objective	Specification	Camera adapter	
		0.5X (included)	1X (optional)
0.3X (optional)	magnification	5~34X	10~68X
	focus distance	287±2mm	287±2mm
	view field	42×26~6.5×4.5mm	21×13~3.3×2.3mm
0.5X (optional)	magnification	9~56X	18~112X
	focus distance	166±2mm	166±2mm
	view field	25.6×16.8~5×3.5mm	12.8×8.4~2×1.3mm
0.75X (optional)	magnification	13~84X	26~168X
	focus distance	105±2mm	105±2mm
	view field	17×10.5~2.6×1.7mm	8.5×5.3~1.3×0.9mm
1X (included)	magnification	15~100X	30~200X
	focus distance	70±2mm	70±2mm
	view field	16×11~2.5×1.6mm	7.8×5.3~1.2×0.8mm
1.5X (optional)	magnification	26~168X	52~336X
	focus distance	42±2mm	42±2mm
	view field	8.5×5.2~1.3×0.9mm	4.3×2.6~0.7×0.5mm
2X (optional)	magnification	30~200X	60~400X
	focus distance	29±2mm	29±2mm
	view field	7.8×5.3~1.2×0.8mm	3.8×2.7~0.6×0.4mm

*For auxiliary objectives 0.3X, 0.5X, 0.75X, use contour illumination of ISM-DL301, ISM-DL400, ISM-DL510, 5310-DL401 or LED light

DIGITAL MICROSCOPES



MEASUREMENT

TAKE PICTURES AND VIDEOS



5309-DM50

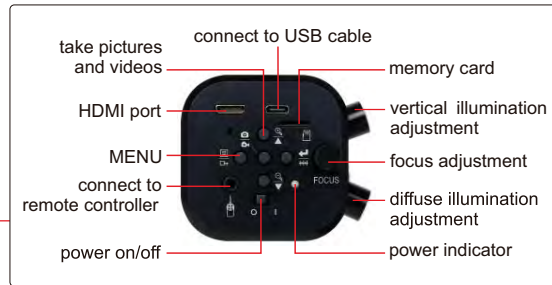

5309-DM51

- Independent control of vertical illumination and diffuse illumination
- Back focus adjustment extends working distance
- Take pictures and videos, save to memory card

SPECIFICATION

Code	5309-DM50	5309-DM51
Arm type	straight	universal
Sensor	1/2.8" CMOS	
Pixel	2M	
Resolution	1920×1080	
Exposure	real-time auto, single auto, manual adjustment	
White balance	real-time auto, single auto, manual RGB adjustment	
Record format	pictures: JPG videos: MOV	
Record media	memory card	
Working distance	45~169mm	42~195mm
Magnification	9~41X	7.6~49.4X
View field	7.6×4~38.5×21.7mm	7×4~45×25mm
Power supply	DC12V 3A	

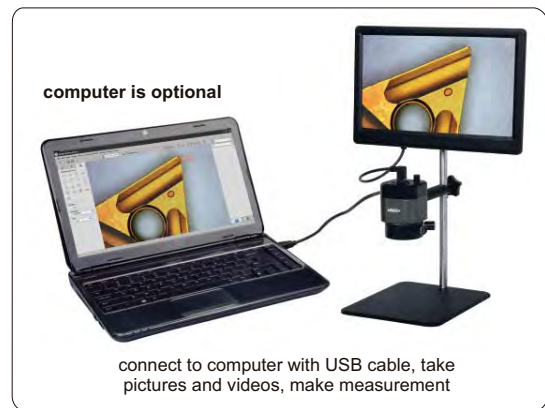

USE COMPUTERS, OPTIONAL

Image magnification	View field	Measuring accuracy
9.0X	38.5×21.7mm	±0.02mm
13.0X	26.6×15.0mm	±0.02mm
17.0X	20.5×11.7mm	±0.02mm
22.0X	16.0×9.0mm	±0.02mm
28.5X	11.9×6.3mm	±0.02mm
34.0X	9.8×5.5mm	±0.01mm
41.0X	7.6×4.1mm	±0.01mm

STANDARD DELIVERY

Main unit	1 pc
Memory card and holder	1 pc
Plastic calibration rule (graduation 1mm)	1 pc
White/black plate	1 pc
Remote controller	1 pc
USB cable	1 pc
Measuring software	1 pc
Power adapter	1 pc

To be continued

Continued from previous page



remote controller (included)



white/black plate (included)



plastic calibration rule (graduation 1mm, included)

SOFTWARE FOR COMPUTER

- **Language:** Chinese (Simplified), English, French, Chinese (Traditional), Portuguese, Korean, Japanese
- **Operation system:** Windows 7/8/8.1/10 (64bit)

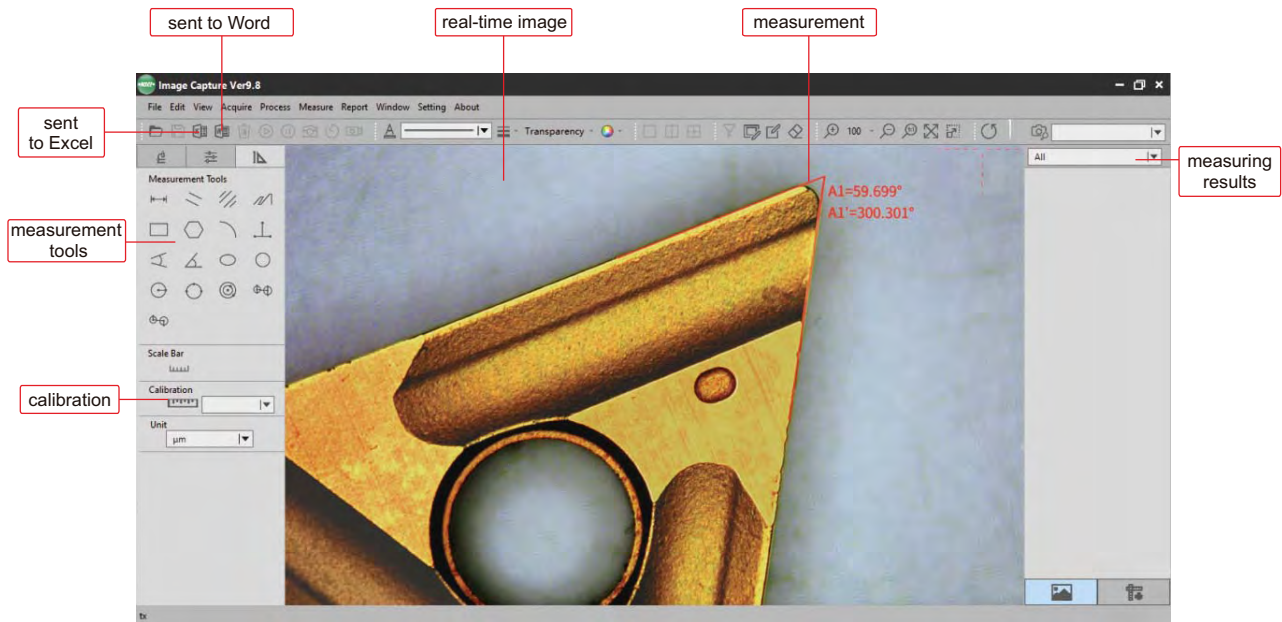

Measurement tools:

- | | | | |
|--|-------------------------------------|--|---------------------------------------|
| straight line distance measurement | parallel lines distance measurement | centre distance between parallel lines measurement | polyline line measurement |
| rectangular measurement | polygon measurement | arc measurement | three-vertical-line measurement |
| four-point perspective measurement | angle measurement | ellipse measurement | round measurement |
| circle measurement by radius | circle measurement by 3-point | torus measurement | center distance measurement by radius |
| center distance measurement by 3-point | | | |

Data is sent to Word or Excel:

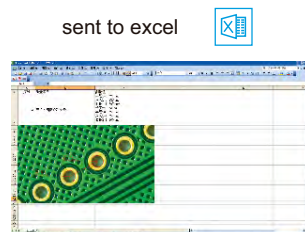
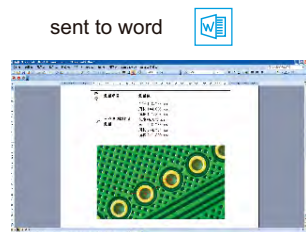

MINI DIGITAL MICROSCOPE (ECONOMIC TYPE) CODE 5311-M710



TAKE PICTURES
AND VIDEOS

BUILT-IN
LITHIUM BATTERY

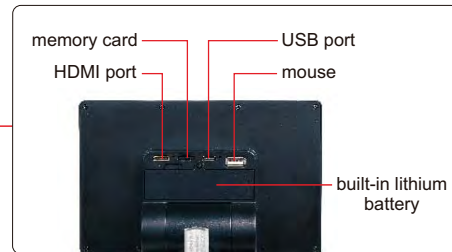
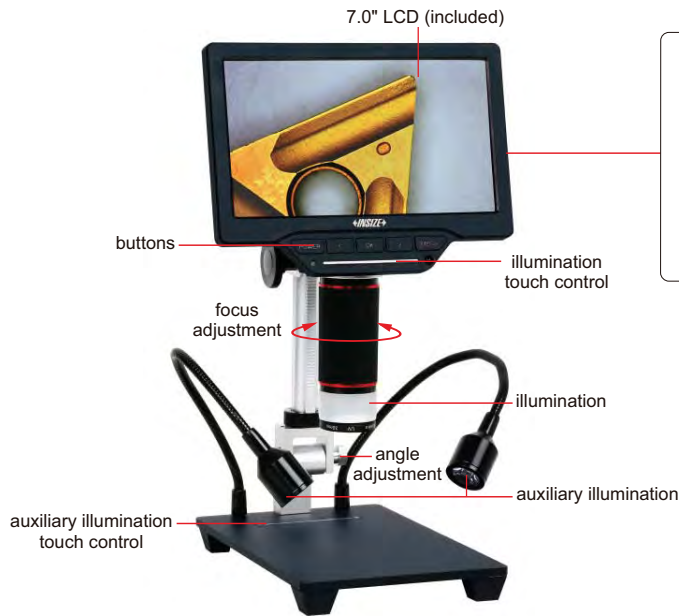

8G memory card
and holder (included)



infrared ray remote
controller (included)

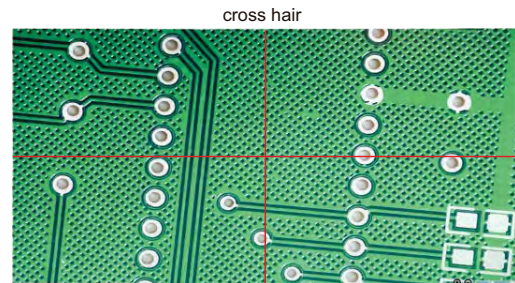

cross hair

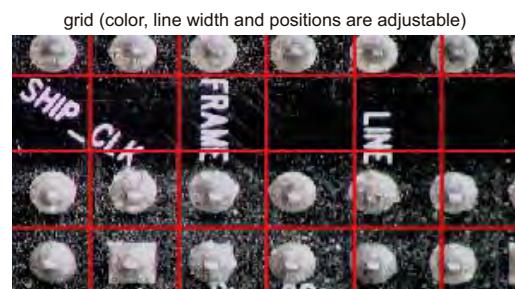

grid (color, line width and positions are adjustable)

SPECIFICATION

Display resolution	1024×600
Sensor	1/3" CMOS
Sensor resolution	1280×960
Single pixel size	2μm×2μm
Frame rate	60fps/30fps
Magnification	1X~16X
White balance	auto/manual (10 levels RGB)/calibration
Exposure control	AE lock/exposure compensation (10 levels)
Image control	contrast/saturation/sharpness
Record media	memory card
Output	HDMI
Power supply	built-in lithium battery/power adapter
Dimension (L×W×H)	174×200×350mm
Weight	1.5kg

STANDARD DELIVERY

Main unit	1 pc
USB cable	1 pc
HDMI cable	1 pc
IR remote controller	1 pc
8G memory card and holder	1 pc
Plastic calibration rule	1 pc
Power adapter	1 pc

To be continued

Continued from previous page

▪ **Screen freezing:**

full screen

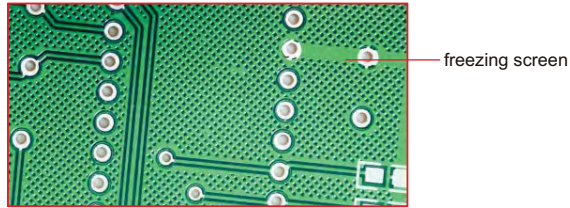

up-down split screen

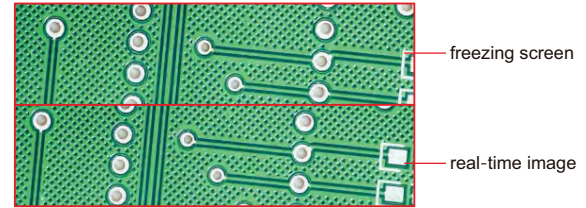

left-right split screen

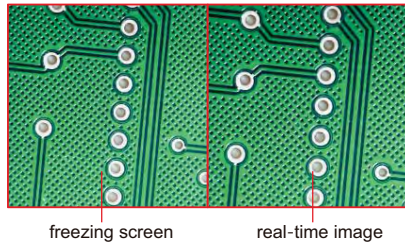

1/4 split screen

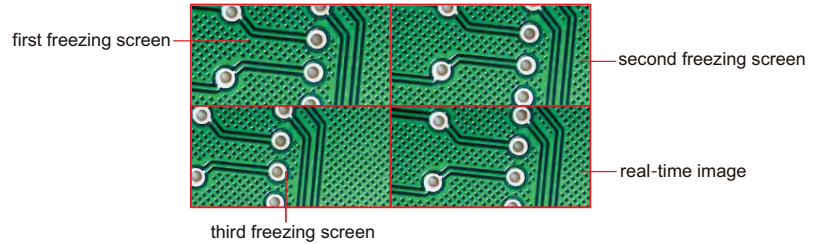

SOFTWARE FOR COMPUTER (included)

- **Language:** Chinese (Simplified), English
- **Operation system:** Windows 7/8/8.1/10 (64bit)
- **Port:** USB2.0 or above
- **Measuring accuracy:** 0.02mm

- | | | | |
|------------------------------|--------------------------------------|---------------------------------|---|
| point counting | straight line length | continuous line length | area of a rectangle |
| area of a polygon | distance between 2 lines | distance between parallel lines | distance between line and first parallel line |
| point-line distance | cross line | double cross line | angle |
| arc | radius of a circle | radius of a 2-point circle | radius of a 3-point circle |
| center distance of 2 circles | center distance of concentric circle | | |

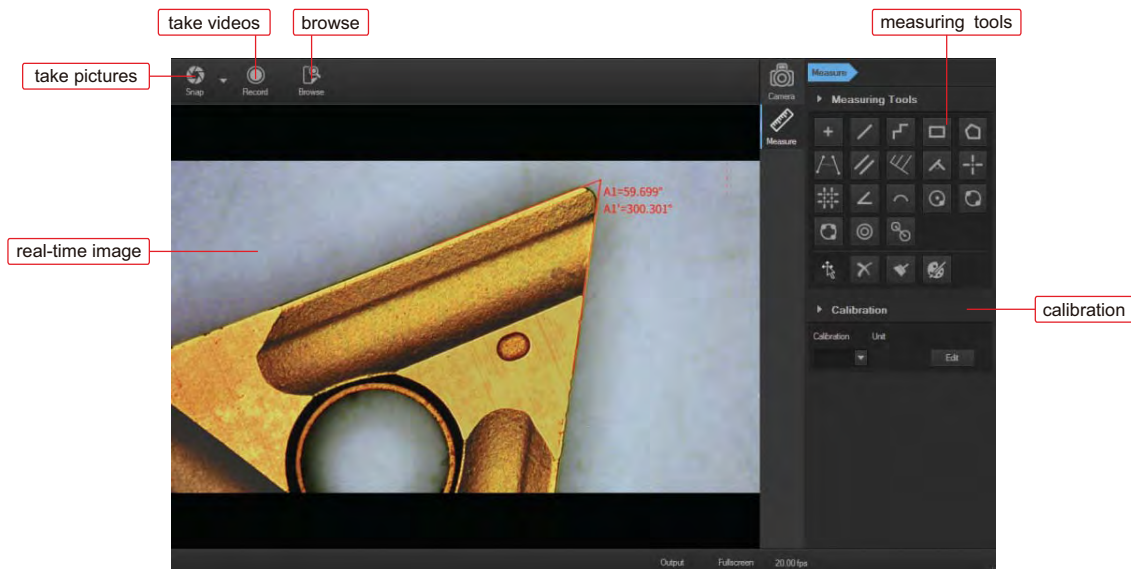

DIGITAL MEASURING MICROSCOPES

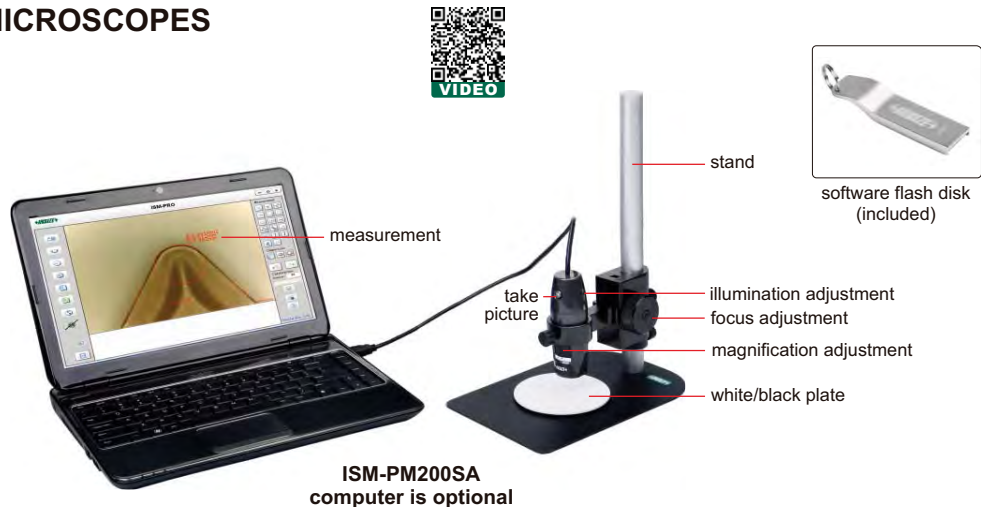
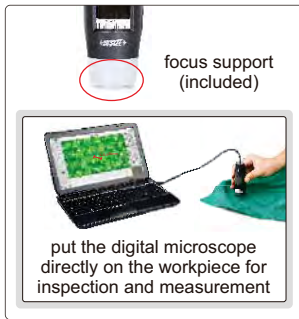

- Can take pictures and videos
- Supplied with software
- Calibration rules (graduation 0.1 and 1mm) are included
- With focus support

SPECIFICATION

Code	ISM-PM200SA	ISM-PM200SB
Magnification	10X~200X	10X~200X
Stand	standard	universal
Pixel	2M (resolution: 1600×1200)	
Illumination	built-in adjustable LED	
Power supply	USB 2.0 cable (voltage required: 5±0.1V)	

OPTIONAL ACCESSORY

Green filter	ISM-PM-GREEN
Yellow filter	ISM-PM-YELLOW
Blue filter	ISM-PM-BLUE

SOFTWARE

- Language:** English, Japanese, Korean, German, Turkey, Portuguese, Chinese
- Operation system:** Windows 7/8/XP/Vista
- Measuring tools:**

- | | | | |
|--|---|--|--|
| | measure length of line or distance between two points | | measure radius, length and angle of arc |
| | measure area of rectangle | | add number with circle |
| | measure distance between two circles | | measure length of continuous line |
| | measure distance between two parallel lines | | measure angle with three points |
| | measure angle with two lines | | measure radius, girth and area of circle |
| | measure distance between point and line | | add text |

Edge detection measurement tools:

- detect two parallel lines automatically and calculate distance
- detect circle automatically, and calculate radius, girth and area
- detect arc automatically, and calculate radius, angle and arc length
- detect two lines automatically, and calculate angle
- detect line automatically, and calculate length

universal stand (included in ISM-PM200SB)



filter (optional)



MAGNIFICATION, FOCUS DISTANCE, VIEW FIELD AND ACCURACY

Magnification	Focus distance	View field	Accuracy
50X	21mm	8.1×6.4mm	30μm
100X	13mm	3.9×3.1mm	15μm
150X	16mm	2.6×2.1mm	10μm
200X	19mm	1.8×1.5mm	8μm

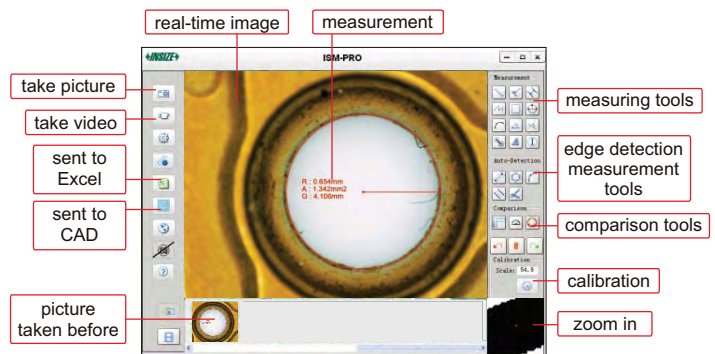

Comparison tools:

Create line, angle or circle with desired size, to compare with workpieces

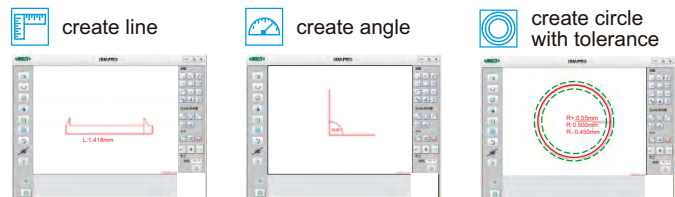

Data is sent to CAD or Excel:

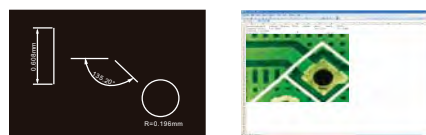



WiFi DIGITAL MEASURING MICROSCOPE CODE ISM-WF200

- Maximum working distance is 5m under WiFi mode
- Can be connected to multiple iPads, Android devices or computers together under WiFi mode
- Take pictures and videos
- Supplied with software



stand (code ISM-PM-STAND, optional)



software flash disk (included)



filter (optional)



plastic calibration rule (graduation 1mm, included)

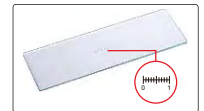

glass calibration rule (graduation 0.1mm, included)

SPECIFICATION

Magnification	10X~200X
Pixel	1.3M (resolution: 1280×1024)
Illumination	built-in adjustable LED
Power supply	built-in rechargeable battery



connected to iPad by WiFi

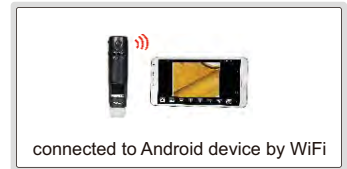

connected to Android device by WiFi

STANDARD DELIVERY

Microscope	1 pc
Focus support ring for 80X/150X	1 pc
Focus support ring for 60X/200X	1 pc
Glass calibration rule (graduation 0.1mm)	1 pc
Plastic calibration rule (graduation 1mm)	1 pc
Software and USB cable	1 pc
AC/DC adapter	1 pc



connected to computer by WiFi



connected to computer by USB cable

OPTIONAL ACCESSORY

Stand	ISM-PM-STAND
Green filter	ISM-PM-GREEN
Yellow filter	ISM-PM-YELLOW
Blue filter	ISM-PM-BLUE

MAGNIFICATION, FOCUS DISTANCE, VIEW FIELD AND ACCURACY

Magnification	Focus distance	View field	Accuracy
50X	21mm	8.1×6.4mm	30μm
100X	13mm	3.9×3.1mm	15μm
150X	16mm	2.6×2.1mm	10μm
200X	19mm	1.8×1.5mm	8μm

1 Software ISM-PAD (for iPad by WiFi)

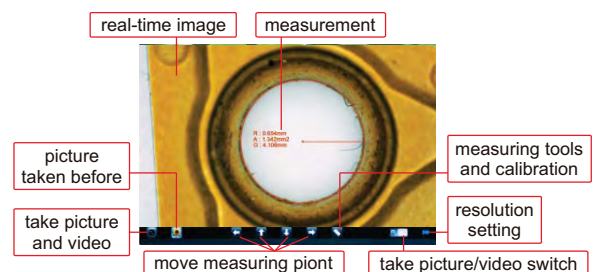

- measure length of line or distance between two points
- measure radius, girth and area of circle with three points
- measure angle



To be continued







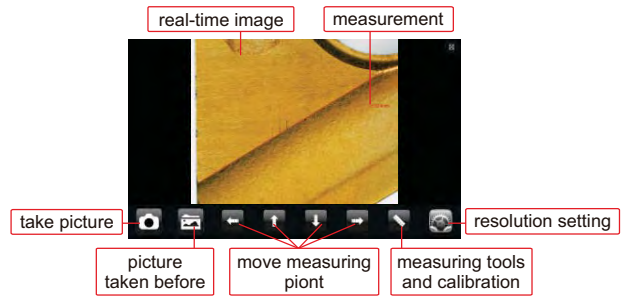



Continued from previous page

2 Software ISM-APK (for Android devices by WiFi)

-  measure length of line or distance between two points
-  measure radius, girth and area of circle with three points
-  measure angle







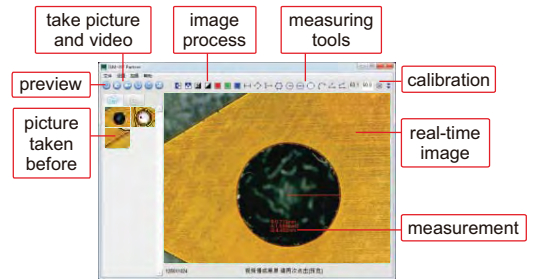







3 Software ISM-WF Partner (for computer by WiFi)

- | | |
|--|--|
|  measure length of line or distance between two points |  measure angle with two lines |
|  measure area of polygon |  measure radius, girth and area of circle with two points |
|  measure angle with three points |  measure distance between point and line |
|  measure radius, girth and area of circle with center point |  measure radius, length and angle of arc |
|  measure length of continuous line |  measure area of rectangle |
|  measure radius, girth and area of circle with three points | |



4 Software ISM-PRO (for computer by USB cable)

Measuring tools:

- | | |
|---|---|
|  measure length of line or distance between two points |  measure distance between point and line |
|  measure length of continuous line |  measure area of rectangle |
|  measure radius, length and angle of arc |  measure angle with two lines |
|  measure distance between two circles |  add number with circle |
|  measure distance between two parallel lines |  measure angle with three points |
|  measure radius, girth and area of circle |  add text |

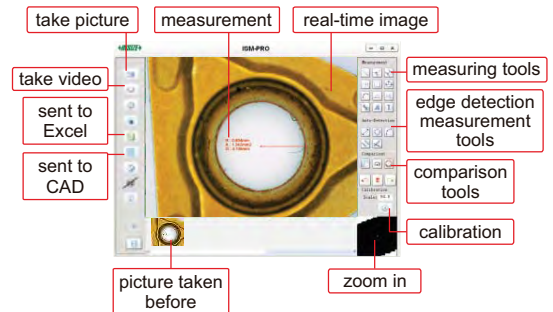

Edge detection measurement tools:

- | | |
|--|--|
|  detect line automatically, and calculate length |  detect two lines automatically, and calculate angle |
|  detect arc automatically, and calculate radius, angle and arc length |  detect two parallel lines automatically and calculate distance |
|  detect circle automatically, and calculate radius, girth and area | |

Comparison tools:

Create line, angle or circle with desired size, to compare with workpieces

-  create line
-  create angle
-  create circle with tolerance

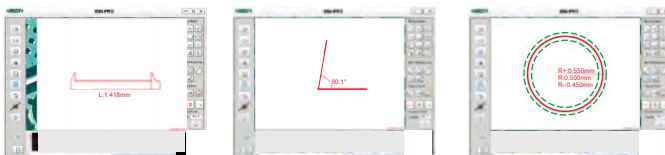

Data is sent to CAD or Excel:

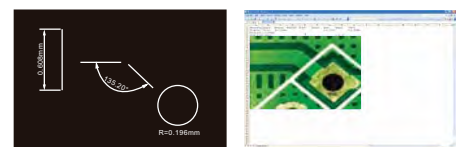

INDUSTRIAL MICROSCOPES



5101-M500

- Infinite optical system, polarization observation, dark field observation
- Kohler illumination system provides uniform illumination field
- Objective 50X is spring type

SPECIFICATION

Code	5101-M500 (bright field objectives)				5101-M500BD (bright & dark field objectives)			
Illumination	6V/30W halogen lamp, brightness is adjustable				12V/50W halogen lamp, brightness is adjustable			
Objective (infinite plan achromatic)	bright field objectives				bright & dark field objectives			
	5X	10X	20X	50X	5X	10X	20X	50X
Working distance	26.1mm	20.2mm	8.80mm	3.68mm	9.70mm	9.30mm	7.23mm	2.50mm
Numerical aperture	0.12	0.25	0.40	0.70	0.12	0.25	0.40	0.70
Magnification	50X~500X							
Eyepiece (wide field)	10X (view field: Ø22mm)							
Stage	double layer							
	size: 160×140mm travel: 35×30mm							
Pupil distance	53~75mm							
Diopter adjustment	±5 diopter (one eyepiece)							
Power supply	220V, 50/60Hz							
Dimension (L×W×H)	415×345×380mm							
Weight	14kg							

STANDARD DELIVERY

Main unit	1 pc
Anti-dust cover	1 pc

OPTIONAL ACCESSORY

Bright & dark field objective (for 5101-M500BD)	PL40X	5101-M-BD40X
	PL60X	5101-M-BD60X
	PL80X	5101-M-BD80X
	PL100X	5101-M-BD100X
10X dividing eyepiece (0.1mm/div.)		5101-M-EPD10X
Bright field objective (for 5101-M500)	PL40X	5101-M-OB40X
	PL60X	5101-M-OB60X
	PL80X	5101-M-OB80X
	PL100X	5101-M-OB100X
Digital camera		ISM-CM20, ISM-CM63, ISM-ZS70-S
Camera adapter *		5101-M-ADAPTER

* Digital camera must be used with camera adapter

INDUSTRIAL INSPECTION MICROSCOPE (LARGE STAGE) CODE 5104-M700



- For observation and inspection of large IC and chip in IT industry

SPECIFICATION

Magnification	40X~400X			
Eyepiece (wide field)	10X (view field: Ø22mm)			
Objective (plan achromatic)	4X	10X	20X	40X
Numerical aperture	0.10	0.25	0.40	0.60
Working distance	17.8mm	10mm	5.8mm	2.9mm
Stage	double layer, size: 300×268mm, travel: 250×200mm			
Kohler illumination	6V/20W halogen lamp, brightness is adjustable built-in green, blue, yellow and frosted glasses			
Pupil distance	48~75mm			
Diopter adjustment	±5 diopter (two eyepieces)			
Power supply	220V, 50/60Hz			
Dimension (L×W×H)	647×268×376mm			
Weight	12kg			

STANDARD DELIVERY

Main unit	1 pc
Camera connector	1 pc
Anti-dust cover	1 pc

OPTIONAL ACCESSORY

Bright field objective	5X plan achromatic objective (focus distance: 15.5mm)	5104-M700-OB5X
	50X plan achromatic objective (focus distance: 0.32mm)	5104-M700-OB50X
	100X plan achromatic objective (focus distance: 2mm)	5104-M700-OB100X
Polarizer and analyzer		5104-M700-AP
Digital camera		ISM-CM20, ISM-CM63, ISM-ZS70-S
Camera adapter 0.5X*		ISM-MAS-ADAPTER

*Digital camera must be used with camera adapter

METALLURGICAL MICROSCOPES



5102-M600

- Infinite optical system, observation in reflected or transmitted illumination, polarizing observation
- Kohler illumination system provides uniform illumination field
- Objectives 40X, 60X are spring type

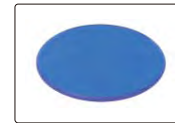

blue filter (included)



frosted glass filter (included)

SPECIFICATION

Code	5102-M600 (bright field objectives)				5102-M600BD (bright & dark field objectives)			
Illumination	6V/30W (transmitted)		6V/30W (reflected)		12V/30W (transmitted)		12V/50W (reflected)	
Objective (infinite plan achromatic)	bright field objectives				bright & dark field objectives			
	5X	10X	40X	60X	5X	10X	20X	40X
Working distance	26.1mm	20.2mm	3.98mm	3.18mm	9.70mm	9.30mm	7.20mm	3.00mm
Numerical aperture	0.12	0.25	0.60	0.70	0.12	0.25	0.40	0.70
Magnification	50X~600X				50X~400X			
Eyepiece (wide field)	10X (view field: Ø22mm)							
Stage	double layer							
	size: 210×140mm							
	travel: 75×50mm							
Pupil distance	53~75mm							
Diopter adjustment	±5 diopter (one eyepiece)							
Power supply	220V, 50/60Hz							
Dimension (L×W×H)	456×260×498mm							
Weight	11kg							

STANDARD DELIVERY

Main unit	1 pc
Anti-dust cover	1 pc
Filter (blue/frosted glass)	1 pc of each

OPTIONAL ACCESSORY

Bright & dark field objective (for 5102-M600BD)	PL50X	5101-M-BD50X
	PL60X	5101-M-BD60X
	PL80X	5101-M-BD80X
	PL100X	5101-M-BD100X
10X dividing eyepiece (0.1mm/div.)		5101-M-EPD10X
Bright field objective (for 5102-M600)	PL20X	5101-M-OB20X
	PL50X	5101-M-OB50X
	PL80X	5101-M-OB80X
	PL100X	5101-M-OB100X
Digital camera		ISM-CM20, ISM-CM63, ISM-ZS70-S
Camera adapter *		5101-M-ADAPTER

* Digital camera must be used with camera adapter

METALLURGICAL MICROSCOPES (PROFESSIONAL TYPE)



5108-M3000

- Infinite chromatic aberration correction optical system
- Three way observation tube with infinite hinge
- Translucent and reflective frame, front low-hand position coarse and fine coaxial focus adjustment mechanism, with adjustment elastic device to prevent sliding and random upper limit device
- Bright and dark field five-hole converter with DIC slot
- Adopt digital dimming, with light intensity reset and setting function
- With polarizer insert plate and 360° rotating analyzer insert slot

SPECIFICATION

Code	5108-M3000 (standard type)				5108-M3000H (high-definition type)			
Eyepiece	high eye point large field SWH10X-H (view field: Ø25mm, adjustable visibility)							
Objective (infinite long working distance bright and dark field semi achromatic)	5X	10X	20X	50X	5X	10X	20X	50X
Working distance	15mm	8.4mm	10.3mm	3.0mm	20mm	11mm	3.0mm	1.0mm
Numerical aperture	0.15	0.30	0.40	0.75	0.15	0.30	0.45	0.80
Optical magnification	50X~500X (up to 1000X with optional 100X objective)							
Digital magnification	170X~1700X (on 21.5" monitor), up to 3400X with optional 100X objective							
Stage	double layer							
	size: 310×240mm							
	travel: 150×100mm							
Condenser	roll-out achromatic condenser (numerical aperture 0.9)							
Illumination	5W LED, transmitted and reflected							
Observation tube	inverse image, distance adjustment: 50~76mm, two grade spectral ratio binocular: trinocular=100:0							
Diopter adjustment	±5 diopter (two eyepieces)							
Power supply	AC 100-240V							
Dimension (L×W×H)	310×600×500mm							
Weight	27kg							

OPTIONAL ACCESSORY

Camera and software	ISM-CM63
Glass calibration rule	ISM-MAS-SCALE
Computer	5108-M-COMPUTER
2.5X infinite long working distance bright field semi achromatic objective	5108-M-OB2D5X
100X infinite long working distance bright and dark field semi achromatic objective	5108-M-BD100X
50X infinite long working distance bright and dark field achromatic objective	5108-M-APO50X
100X infinite long working distance bright and dark field achromatic objective	5108-M-APO100X
Differential interference module (DIC)	5108-M-DIC

STANDARD DELIVERY

Main unit	1 pc
Anti-dust cover	1 pc
0.65X camera adapter (adjustable focus)	1 pc
Polarizer and analyzer	1 pc of each

METALLURGICAL MICROSCOPES



5103-M1000

- Infinite optical system, polarization observation
- Kohler illumination system provides uniform illumination field
- Objectives 50X, 100X are spring type

SPECIFICATION

Code	5103-M1000 (bright field objectives)				5103-M1000BD (bright & dark field objectives)			
Illumination	6V/30W halogen lamp, brightness is adjustable				12V/50W halogen lamp, brightness is adjustable			
Objective (infinite plan achromatic)	bright field objectives				bright & dark field objectives			
	10X	20X	50X	100X	5X	10X	20X	50X
Working distance	20.2mm	8.80mm	3.68mm	0.40mm	9.70mm	9.30mm	7.23mm	2.50mm
Numerical aperture	0.25	0.40	0.70	0.85	0.12	0.25	0.40	0.70
Magnification	100X~1000X				50X~500X			
Eyepiece (wide field)	10X (view field: Ø22mm)							
Stage	double layer							
	size: 242×200mm							
	travel: 30×30mm							
Pupil distance	53~75mm							
Diopter adjustment	±5 diopter (one eyepiece)							
Power supply	220V, 50/60Hz							
Dimension (L×W×H)	614×250×394mm							
Weight	13kg							

STANDARD DELIVERY

Main unit	1 pc
Polarizer and analyzer	1 pc of each
Anti-dust cover	1 pc

OPTIONAL ACCESSORY

Bright & dark field objective (for 5103-M1000BD)	PL40X	5101-M-BD40X
	PL60X	5101-M-BD60X
	PL80X	5101-M-BD80X
	PL100X	5101-M-BD100X
10X dividing eyepiece (0.1mm/div.)		5103-M-EPD10X
Bright field objective (for 5103-M1000)	PL5X	5101-M-OB5X
	PL40X	5101-M-OB40X
	PL60X	5101-M-OB60X
	PL80X	5101-M-OB80X
Digital camera		ISM-CM63
Camera adapter*		5101-M-ADAPTER

*Digital camera must be used with camera adapter

PORTABLE METALLURGICAL MICROSCOPE CODE 5109-PM500

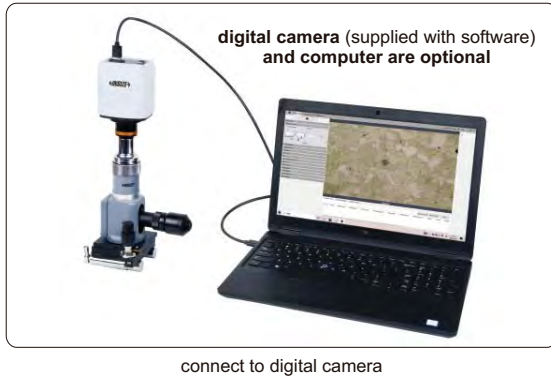

- Illumination is powered by batteries
- Aperture diaphragm improves image quality and increases depth of field
- Magnetic base with on/off switch can adhere on metal workpieces
- Can be connected to digital cameras

SPECIFICATION

Magnification	100X~500X	
Eyepiece (wide field)	10X/12.5X	
Objective (plan achromatic)	10X (included)	40X (included)
Numerical aperture	0.25	0.64
Illumination	3W LED, built-in batteries	
Stage	double layer, size: 15×12mm	
Dimension (L×W×H)	210×160×95mm	
Weight	1.5kg	

STANDARD DELIVERY

Main unit	1 pc
Eyepiece	2 pcs
Objective	2 pcs
Battery (AAA)	3 pcs

OPTIONAL ACCESSORY

Objective	5X plan achromatic	5109-PM500-OB5X
	20X plan achromatic	5109-PM500-OB20X
	100X plan achromatic	5109-PM500-OB100X
Eyepiece	5X	5109-PM500-EP5X
	15X	5109-PM500-EP15X
Digital camera*	ISM-CM20, ISM-CM63, ISM-ZS70-S	
Camera adapter 0.5X	ISM-MAS-ADAPTER	

* Digital camera must be used with camera adapter

ZOOM STEREO MICROSCOPE (PROFESSIONAL TYPE) CODE 5107-S70T



LED ring light (optional)



- Greenough optical system, clear observation, real color
- High working distance is convenient for operation
- Excellent flat image and large depth of field, make observation comfortable
- 6.7:1 large zoom ratio, allow quick observation adjustment

SPECIFICATION

Optical tube	trinocular
Eyepiece (wide field)	10X (view field: Ø22mm)
Objective	0.67X~4.5X (zoom)
Observation tube	45° trinocular tube inclination angle, built-in 0.5X adapter
Zoom ratio	6.7:1
Pupil distance	50~75mm
Diopter adjustment	-8~+5 diopter (both eyepieces)
Working distance of objective	110mm
Max. workpiece height	106mm
Illumination	adjustable LED light
Power supply	110/220V, 50/60HZ
Dimension (L×W×H)	330×300×368mm
Weight	3.5kg



frosted glass filter
(included)



white/black plate
(included)

STANDARD DELIVERY

Main unit	1 pc
10X eyepiece	2 pcs
Ø100mm glass plate	1 pc
Ø100mm white/black plate	1 pc
Anti-dust cover	1 pc

OPTIONAL ACCESSORY

Auxiliary objective	0.5X	5107-S70T-OB05X
	1.5X	5107-S70T-OB15X
	2X	5107-S70T-OB20X
Eyepiece	15X (view field: Ø16mm)	5107-S70T-EP15X
	20X (view field: Ø12.5mm)	5107-S70T-EP20X
LED ring light		ISM-ZS-RL
Digital camera		ISM-CM20, ISM-CM63, ISM-ZS70-S

PARALLEL LIGHT STEREO MICROSCOPE CODE ISM-ZS200

PARALLEL LIGHT PATH: REDUCE FATIGUE,
ACCESSORIES CAN BE ADDED INTO LIGHT PATH

coaxial illumination (optional)



- Infinity parallel optical system and 20° inclined optical tube reduce fatigue
- Coaxial illumination is optional for deep holes which cannot be observed by ring light
- Aperture diaphragm is optional for large depth of field and high quality image

optical path splitter (optional)



iris diaphragm (optional)



SPECIFICATION

Optical tube	binocular (20° inclined)
Eyepiece (wide field)	10X (view field: Ø22mm)
Objective	0.8X~8X (zoom)
Zoom ratio	1:10
Pupil distance	55~75mm
Diopter adjustment	±5 diopter (both eyepieces)
Working distance of objective	78mm
Max. workpiece height	72mm
Illumination	adjustable reflected and transmitted LED light
Power supply	110/220V, 50/60HZ
Dimension (L×W×H)	240×280×440mm
Weight	4.3kg

STANDARD DELIVERY

Main unit	1 pc
WF10X eyepiece	2 pcs
Ø100mm glass plate	1 pc
Ø100mm white/black plate	1 pc
Anti-dust cover	1 pc

OPTIONAL ACCESSORY

Objective	0.5X achromatic objective (focus distance: 186mm)	ISM-ZS200-OB05X *
	2X plan achromatic objective (focus distance: 32.5mm)	ISM-ZS200-OB2X
	0.5X plan apochromatic objective (focus distance: 126mm)	ISM-ZS200-APO05X *
Eyepiece	WF15X (view field: Ø16mm)	ISM-ZS200-EP15X
	WF20X (view field: Ø12mm)	ISM-ZS200-EP20X
	WF30X (view field: Ø20mm)	ISM-ZS200-EP30X
Sleeve for objective		ISM-ZS200-ADAPTER
Iris diaphragm		ISM-ZS200-IRD
Optical path splitter		ISM-ZS200-OBS
Coaxial illumination		ISM-ZS200-COAXIAL
Digital camera **		ISM-CM20, ISM-CM63

*0.5X auxiliary objective must be used with ISM-ZS200-ADAPTER

**Digital camera must be used with optical path splitter

LARGE ZOOM RATIO

ZOOM STEREO MICROSCOPES (ADVANCED TYPE)

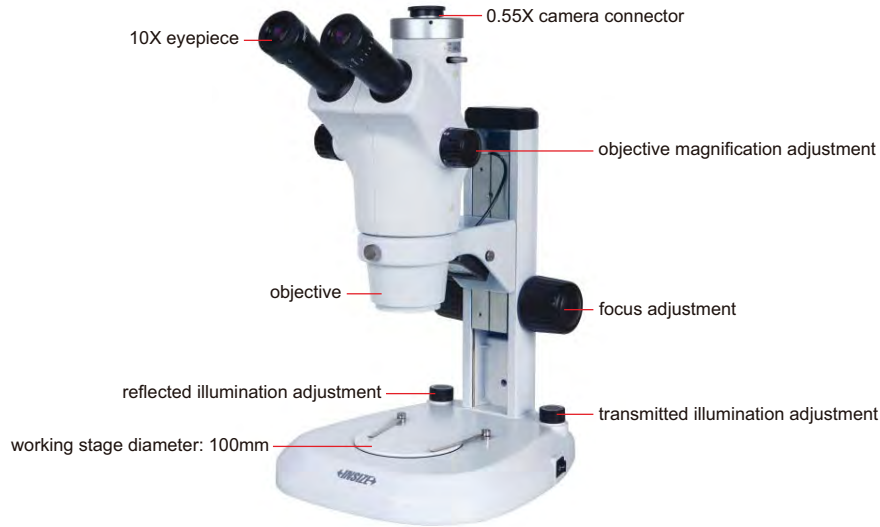

ISM-ZS100T

connect to digital camera (for ISM-ZS100T)



LED ring light (optional)

SPECIFICATION

Code	ISM-ZS100	ISM-ZS100T
Optical tube	binocular	trinocular
Eyepiece (wide field)	10X (view field: Ø23mm)	
Objective	0.6X~5X (zoom)	
Zoom ratio	1:8.3	
Pupil distance	55~75mm	
Diopter adjustment	±5 diopter (two eyepieces)	
Working distance of objective	115mm	
Max. workpiece height	75mm	
Illumination	adjustable reflected and transmitted LED light	
Power supply	110/220V, 50/60HZ	
Dimension (L×W×H)	260×310×490mm	
Weight	4.9kg	

STANDARD DELIVERY

Main unit	1 pc
Camera connector 0.55X for ISM-ZS100T	1 pc
Digital camera adapter 1X for ISM-ZS100T	1 pc
WF10X eyepiece	2 pcs
Ø100mm glass plate	1 pc
Ø100mm white/black plate	1 pc
Anti-dust cover	1 pc

OPTIONAL ACCESSORY

Auxiliary objective	0.5X (focus distance: 220mm)	ISM-ZS100-OB05X *
	0.7X (focus distance: 125mm)	ISM-ZS100-OB07X
	2X (focus distance: 45mm)	ISM-ZS100-OB2X
Eyepiece	WF15X (view field: Ø16mm)	ISM-ZS100-EP15X
	WF20X (view field: Ø12mm)	ISM-ZS100-EP20X
	WF30X (view field: Ø8mm)	ISM-ZS100-EP30X
Sleeve for auxiliary objective		ISM-ZS200-ADAPTER
LED ring light		ISM-ZS-RL
Digital camera for ISM-ZS100T		ISM-CM20, ISM-CM63, ISM-ZS70-S

* 0.5X auxiliary objective must be used with ISM-ZS200-ADAPTER

ZOOM STEREO MICROSCOPES (STANDARD TYPE)



LED ring light (optional)



ISM-ZS50

SPECIFICATION

Code	ISM-ZS50	ISM-ZS50T
Optical tube	binocular	trinocular
Eyepiece (wide field)	10X (view field: Ø22mm)	
Objective	0.8X~5X (zoom)	
Zoom ratio	1:6.3	
Pupil distance	55~75mm (adjustable)	
Diopter adjustment	±5 diopter (two eyepieces)	
Working distance of objective	115mm	
Max. workpiece height	75mm	
Illumination	adjustable reflected and transmitted LED light	
Power supply	110/220V, 50/60HZ	
Dimension (L×W×H)	290×260×480mm	
Weight	4.9kg	

STANDARD DELIVERY

Main unit	1 pc
WF 10X eyepiece	2 pcs
Ø100mm glass plate	1 pc
Ø100mm white/black plate	1 pc
Anti-dust cover	1 pc

OPTIONAL ACCESSORY

Auxiliary objective	0.5X	ISM-ZS50-OB05X*
	2X	ISM-ZS50-OB2X
Eyepiece	10X dividing eyepiece (graduation 0.1mm/div.)	ISM-ZS50-EPD10X
	WF15X (view field: Ø16mm)	ISM-ZS50-EP15X
	WF20X (view field: Ø12mm)	ISM-ZS50-EP20X
LED ring light		ISM-ZS-RL
Sleeve for auxiliary objective		ISM-ZS200-ADAPTER
Digital camera for ISM-ZS50T		ISM-CM20, ISM-CM63, ISM-ZS70-S
Camera adapter 0.5X for ISM-ZS50T**		ISM-MAS-ADAPTER

* 0.5X auxiliary objective must be used with ISM-ZS200-ADAPTER

** Digital camera must be used with camera adapter 0.5X



ZOOM STEREO MICROSCOPES (WITH UNIVERSAL STAND)



5106-M40 (with stand type A)

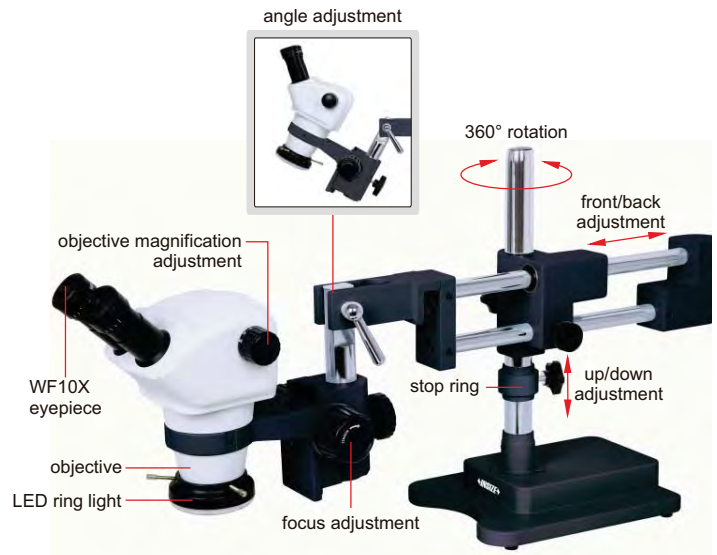

5106-M50 (with stand type B)

SPECIFICATION

Code	5106-M40	5106-M40T	5106-M50	5106-M50T
Stand	type A		type B	
Optical tube	binocular	trinocular	binocular	trinocular
Eyepiece (wide field)	10X (view field: Ø22mm)			
Objective	0.8X~5X (zoom)			
Zoom ratio	1:6.3			
Pupil distance	55~75mm			
Diopter adjustment	±5 diopter (two eyepieces)			
Working distance of objective	115mm			
Max. workpiece height	300mm			
Illumination	adjustable reflected LED ring light			
Power supply	power adapter			
Dimension (L×W×H)	610×220×430mm		790×230×430mm	
Weight	13.7kg		20kg	

STANDARD DELIVERY

Main unit (with stand)	1 pc
WF10X eyepiece	2 pcs
LED ring light	1 pc
Anti-dust cover	1 pc

OPTIONAL ACCESSORY

Auxiliary objective	0.5X	ISM-ZS50-OB05X*
	2X	ISM-ZS50-OB2X
Eyepiece	10X dividing eyepiece (0.1mm/div.)	ISM-ZS50-EPD10X
	WF15X (view field: Ø16mm)	ISM-ZS50-EP15X
	WF20X (view field: Ø12mm)	ISM-ZS50-EP20X
Adapter sleeve		ISM-ZS30-ADAPTER
0.5X adapter (for 5106-M40T/M50T)		ISM-MAS-ADAPTER
Digital camera (for 5106-M40T/M50T)**		ISM-CM20, ISM-CM63

* 0.5X auxiliary objective must be used with ISM-ZS30-ADAPTER

** Digital camera must be used with 0.5X adapter ISM-MAS-ADAPTER

ZOOM STEREO MICROSCOPE (BASIC TYPE) CODE ISM-ZS30



SPECIFICATION

Optical tube	binocular
Eyepiece (wide field)	10X (view field: Ø20mm)
Objective	1X~4.5X (zoom)
Zoom ratio	1:4.5
Pupil distance	55~75mm (adjustable)
Diopter adjustment	±5 diopter (two eyepieces)
Working distance of objective	97mm
Max. workpiece height	60mm
Illumination	adjustable reflected and transmitted LED light
Power supply	110/220V, 50/60HZ
Dimension (L×W×H)	260×190×400mm
Weight	4.3kg



LED ring light (optional)

STANDARD DELIVERY

Main unit	1 pc
WF 10X eyepiece	2 pcs
Ø95mm glass plate	1 pc
Ø95mm white/black plate	1 pc
Anti-dust cover	1 pc

OPTIONAL ACCESSORY

Auxiliary objective	0.5X	ISM-ZS30-OB05X *
	0.63X	ISM-ZS30-OB06X *
	0.75X	ISM-ZS30-OB07X *
	2X	ISM-ZS30-OB2X
Eyepiece	10X dividing eyepiece (graduation 0.1mm/div.)	ISM-ZS30-EPD10X
	WF15X (view field: Ø16mm)	ISM-ZS50-EP15X
	WF20X (view field: Ø12mm)	ISM-ZS50-EP20X
LED ring light		ISM-ZS-RL
Sleeve for auxiliary objective		ISM-ZS30-ADAPTER
Digital camera		ISM-CM63
Camera adapter 0.75X **		ISM-AD-0D75

* 0.5X, 0.63X and 0.75X auxiliary objectives must be used with ISM-ZS30-ADAPTER

** Digital camera must be used with camera adapter 0.75X



LONG WORKING DISTANCE STEREO MICROSCOPES (LOW MAGNIFICATION)



5305-ZS80



5305-ZS90

SPECIFICATION

Code	5305-ZS80 (with metal base)	5305-ZS90 (with magnetic base)
Magnification	8X	
Eyepiece (wide field)	10X (view field: Ø20mm)	
Objective	0.8X	
Pupil distance	55~75mm	
Diopter adjustment	±5 diopter (one eyepiece)	
Working distance of objective	115mm	
Max. workpiece height	100mm	140mm
Dimension (L×W×H)	280x160x370mm	280x180x410mm
Weight	3.7kg	2.1kg

STANDARD DELIVERY

Main unit	1 pc
10X eyepieces	1 pair
0.8X objective	1 pc
Anti-dust cover	1 pc

OPTIONAL ACCESSORY

Eyepiece	WF5X (view field: Ø20mm)	5305-ZS80-EP5X
	WF15X (view field: Ø15mm)	5305-ZS80-EP15X
	WF20X (view field: Ø10mm)	5305-ZS80-EP20X
LED ring light	ISM-ZS-RL	



LED ring light (optional)

POLARIZING MICROSCOPE CODE ISM-POL1000



- Widely used in geology, mineralogy, fossil fuel exploration
- Single polarization, orthogonal polarization or conoscopic observation are available



SPECIFICATION

Magnification	40X-600X				
Eyepiece	10X (view field: \varnothing 20mm)				
Infinite strain free plan achromatic objective	4X (transmitted/reflected)	10X (transmitted/reflected)	20X (transmitted)	40X (transmitted)	60X (transmitted)
Working distance	22.2mm	6.1mm	6.4mm	0.6mm	0.3mm
Numerical aperture	0.1	0.25	0.4	0.65	0.8
Stage	revolving round stage				
	diameter: \varnothing 160mm				
	graduation: 1°, resolution: 6'				
Pupil distance	53-75mm				
Diopter adjustment	\pm 5 diopter (one eyepiece)				
Illumination	12V/50W halogen lamp, brightness is adjustable (reflected illumination)				
	12V/20W halogen lamp, brightness is adjustable (transmitted illumination)				
Power supply	110/220V, 50/60HZ				
Dimension (L×W×H)	614×250×394mm				
Weight	13kg				

STANDARD DELIVERY

Main unit	1 pc
Micrometer	1 pc
Grid plate	1 pc
10X crossing eyepiece (view field: \varnothing 20mm)	1 pc
10X dividing eyepiece (view field: \varnothing 20mm, graduation 0.1mm)	1 pc
λ slip (first class red) and 1/4 λ slip	1 pc
Quartz wedge	1 pc

OPTIONAL ACCESSORY

Objective for reflected system	PL20X	ISM-POL1000-OBR20X
	PL40X	ISM-POL1000-OBR40X
	PL60X	ISM-POL1000-OBR60X
	PL100X	ISM-POL1000-OBR100X
Objective for transmitted system	PL100X	ISM-POL1000-OBT100X
Specimen presser		ISM-POL1000-SP

ATTENTION: CAMERA CONNECTOR AND ADAPTER ARE NEEDED ACCORDING TO MICROSCOPES

DIGITAL CAMERA FOR MICROSCOPES (WITH PAD) CODE ISM-ZS70-S

MEASUREMENT, TAKE PICTURES AND VIDEOS

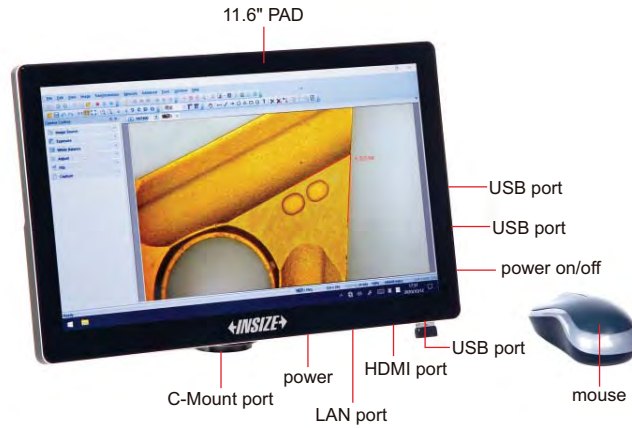
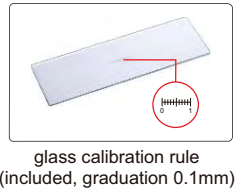

- Windows 10 operation system
- Built-in software, can take pictures and videos, can measure
- Language: Chinese, English, French, Japanese, German, Polish, Arabic
- Automatic exposure, white balance, brightness, contrast ratio, saturation are adjustable
- Image process feature: zoom in/out, flip, mirror, stitching and so on
- Output to Excel or CSV file

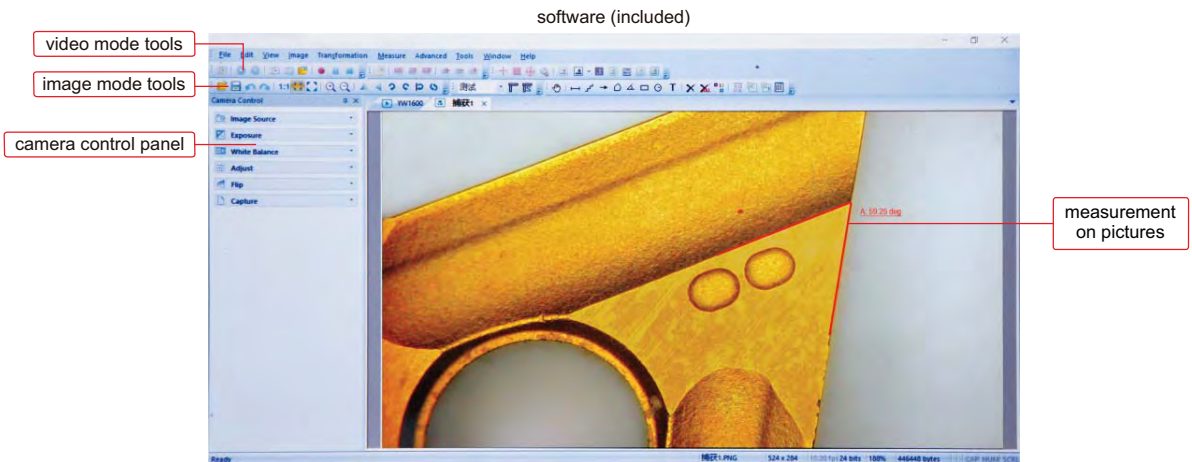

Measuring tools

- measure line
- measure meander line
- arrow mark
- measure polygon
- calibration
- measure angle
- measure rectangle
- measure circle
- text mark
- show/hide scale

SPECIFICATION

Sensor	1/2.3" CMOS
Pixel	16M
Resolution	800×600, 1600×1200, 1920×1080, 2048×1536, 2304×1728, 2592×1944, 4608×3456
Frame rate	30fps (1920×1080)
Output	HDMI, USB 3.0
Power supply	power adapter
Dimension (L×W×H)	280.3×177.4×12.5mm
Weight	0.9kg

STANDARD DELIVERY

Main unit	1 pc
Mouse	1 pc
Glass calibration rule (graduation 0.1mm)	1 pc
AC/DC adapter	1 pc

DIGITAL CAMERA FOR MICROSCOPES CODE ISM-CM63



**ATTENTION: ADAPTERS ARE NEEDED
ACCORDING TO MICROSCOPES**

- To be used with computers
- Sony Exmor back-illuminated CMOS sensor
- USB3.0 transmission
- Automatic exposure, gain adjustment, white balance, chrominance adjustment, saturation adjustment, gamma correction, luminance adjustment, contrast adjustment



C-mount port

adapter 0.75X
(optional)



application



glass calibration rule
(included, graduation 0.1mm)

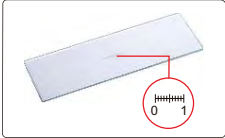

software (included)

selectable resolution

histogram
(quantify the distribution of color and brightness)

black balance
(reduce color difference)

measurement items

flat field correction
(reduce brightness difference)

real time gray calibration

dark field correction
(reduce thermal noise)

The software can control image completely, including measurement, image stitching, extend focus depth, image gray processing, RGB histogram observation, image color sampling, 3D plot (3D representation of image intensity), image exposure, white balance, black balance, image bit depth, flat field correction and dark field correction, etc.

automatic image stitching (expand field of view)

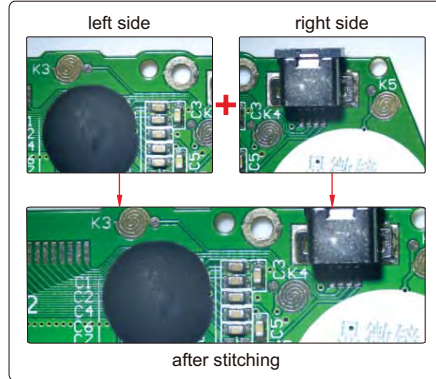

after stitching

counting

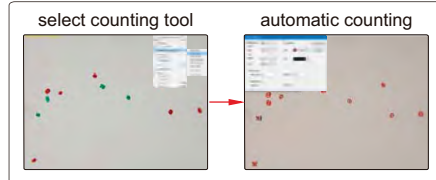

focus stacking



Measuring tools:

- | | |
|---|--|
| measure length of line or distance between two points | measure rectangle |
| measure distance between two parallel lines | measure width and diameter of ring |
| measure angle | measure diameter, length, perimeter angle of arc |
| measure radius, girth and area of circle | measure area of polygon |
| measure axis lengths, girth and area of ellipse | measure center distance between two circles |
| calibration | measure length of open curve |

binary



separate target and background

3D plot



visualize the distribution of image brightness and color

To be continued



Continued from previous page

SPECIFICATION

Sensor (back-up)	1/1.8" CMOS
Resolution	3072×2048
Pixel	6.3M
Single pixel size	2.4×2.4μm
Spectral range	380-650nm (with infrared cut filter)
Frame rate	30fps
Sampling average	1×1
Exposure time	0.1ms~15s
Power supply	USB port
Weight	400g

COMPUTER REQUIREMENT

Operation system	Windows 7/8/10
CPU	Intel Core 2 2.8Hz or above
Memery	2GB or above
USB port	USB3.0 (recommand) or USB2.0
Display	17" or above

STANDAER DELIVERY

Camera (USB cable included)	1 pc
Software	1 pc
Glass calibration rule (graduation 0.1mm)	1 pc

OPTIONAL ACCESSORY

Adapter 0.75X	ISM-AD-0D75
---------------	-------------

**SMART CAMERA
CODE ISM-MV10**



- Built-in software, operated by mouse.
- Automatically calculate, store the test results and sent to Excel
- Camera with PLC control input and output interface, can be integrated with automation equipment
- Functions: presence or absence of objects, position tilt correction, object counting, color detection, stain detection, dimension measurement, position guide, etc.

SPECIFICATION

Chip structure	FPGA+ARM
Operation system	Linux 3.10
Kernel structure	dual-core Cortex-A9
Frequency	1GHZ
I/O port	3 sets of input and output (can be connected to photoelectric switch, wire switch, PLC, etc.)
Operation temperature	-10~70°C
Sensor	1/2" CMOS
Single pixel size	3.75×3.75μm
Resolution	1920×1080
Frame rate	60fps
Video output	HDMI port
Lens connection	standard C port

SOFTWARE

presence or absence of objects



select the area and specify the target, the camera will automatically detect the presence or absence of the target.

automatic counting

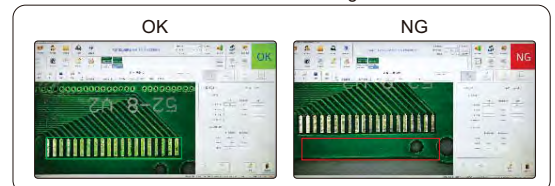

select the area and specify the target, the camera will automatically calculate the number of targets.

dimension measurement

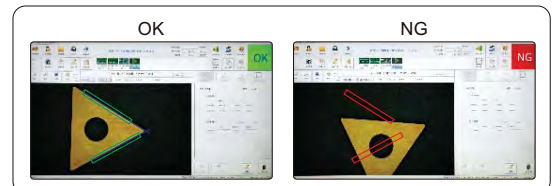

measuring angle, distance, radius, center distance, etc.

STANDAER DELIVERY

Camera (with HDMI cable)	1 pc
Software	1 pc

DIGITAL CAMERA FOR MICROSCOPES CODE ISM-CM20

ATTENTION: ADAPTERS ARE NEEDED
ACCORDING TO MICROSCOPES

FOCUS
STACKING

AUTOMATIC IMAGE
STITCHING

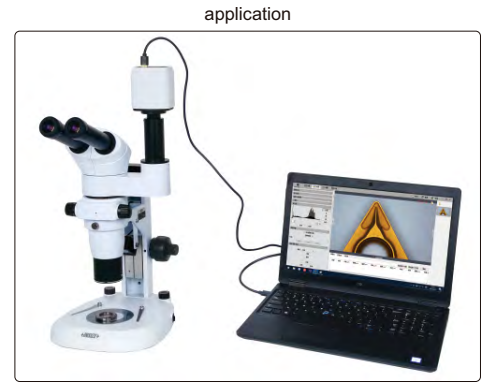
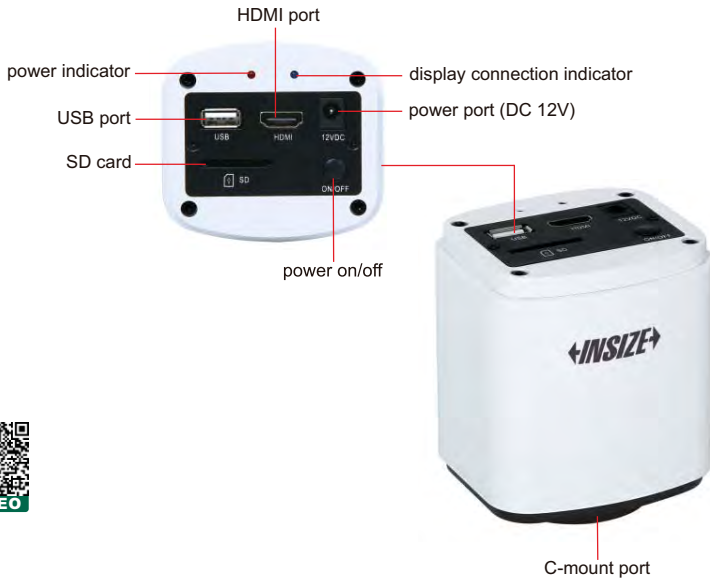

- 1080P high-definition image
- Can be connected with displays or computers
- Built-in simple measuring software for displays, without computer
- Professional measuring software for computers is included
- For bright field, dark field or fluorescent field
- Automatic exposure, white balance, gain adjustment, gamma correction, brightness contrast adjustment, saturation adjustment, chroma sharpness adjustment
- Focus stacking, automatic image stitching

glass calibration rule
(included, graduation 0.1mm)

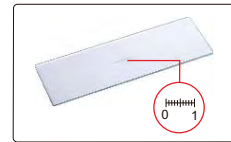

adapter 0.5X (optional)



SIMPLE MEASURING SOFTWARE (BUILT-IN, FOR DISPLAYS)

Measuring tools:

- measure length of line or distance between two points
- measure distance between point and line
- measure rectangle
- measure concentric circles
- measure circle
- measure curve
- measure polygon
- measure center distance of two circles
- measure angle of two lines

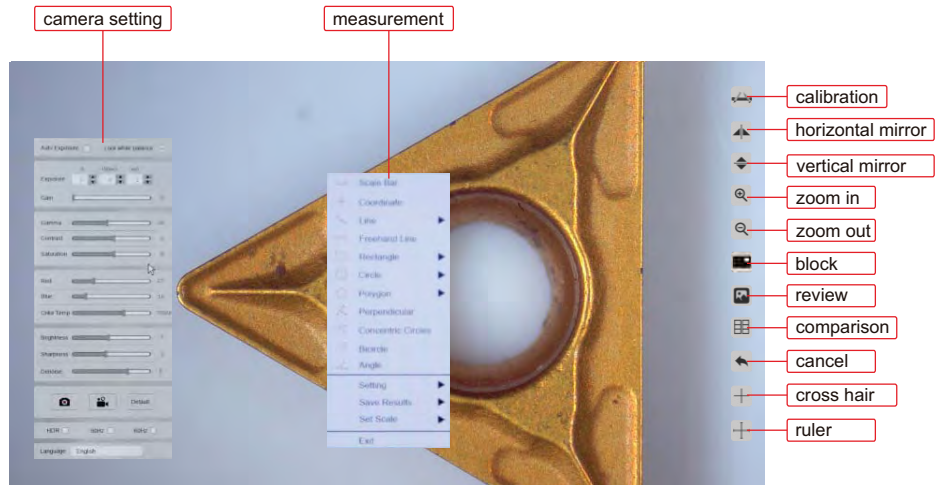

auto exposure, white balance, gain adjustment, gamma, chroma contrast adjustment, brightness sharpness adjustment, size measurement

To be continued

Continued from previous page

PROFESSIONAL MEASURING SOFTWARE (INCLUDED, FOR COMPUTERS)

selectable resolution

white balance
(balance color based on actual light source)

histogram
(quantify the distribution of color and brightness)

flat field correction

metrics flow
(create templates, set tolerances and build metrics flow)

manual counting
(class counting)

image coloring, fluorescence synthesis, binary, image smoothing, color filter/color extraction/
color inversion, delay capture, focus stacking, automatic image stitching, metrics flow, manual
counting, dynamic and static measurement, layered measurement, report generation
and printing, delay record, flat field correction, image adjustment, histogram.

focus stacking

+
→

focus on the top

focus on the bottom

clear image of both top and bottom

automatic image stitching

+
→

+
→

slowly move the workpiece to generate a stitched image automatically (this image can not be used for size measurement)

SPECIFICATION

Sensor	1/2.8" CMOS
Pixel	2M
Resolution	1920×1080
Frame rate	30fps
Power supply	power adapter
Output	HDMI/USB
Lens connection	C-mount

COMPUTER (optional) REQUIREMENT

Operation system	Windows 7/8/10 (64 bit)
CPU	Intel Core i5 or above
Memory	8GB or above
USB port	USB 3.0

DISPLAY (optional) REQUIREMENT

Size	13" or above
Resolution	1080P or above
HDMI port	type A

STANDARD DELIVERY

Main unit	1 pc
16G memory card and holder	1 pc
Glass calibration rule (graduation 0.1mm)	1 pc
Mouse	1 pc
HDMI cable	1 pc
USB cable	1 pc
Power supply	1 pc

OPTIONAL ACCESSORY

Adapter 0.5X	ISM-MAS-ADAPTER
--------------	-----------------

WIFI 4K CAMERA FOR MICROSCOPES CODE ISM-MP8B

WIRELESS AD-HOC NETWORK

AUTOMATIC IMAGE STITCHING

FOCUS STACKING

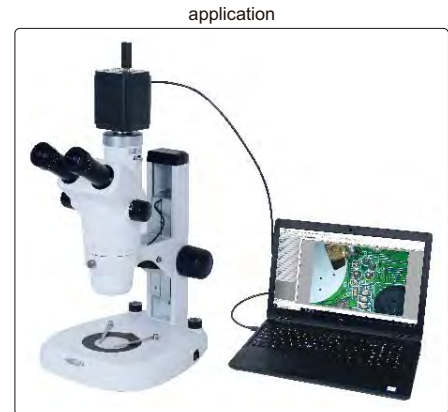
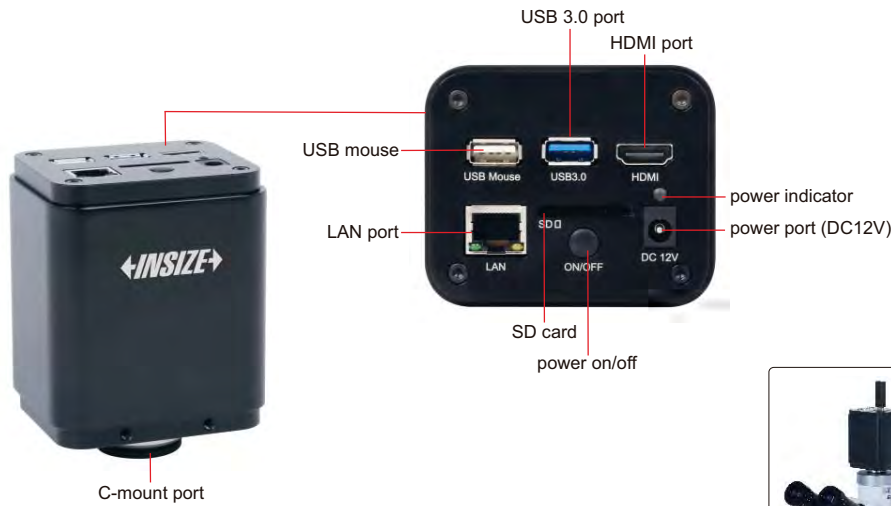

- 4K high-definition image
- Can be connected with displays or computers
- Built-in simple measuring software for display, without computer
- Professional measuring software for computers is included
- 4K HDMI/LAN/USB multiple video outputs
- 4K/1080P automatically switched by display resolution
- Focus stacking, automatic image stitching
- Wireless network or wired network



simple measuring software (built-in, for displays)

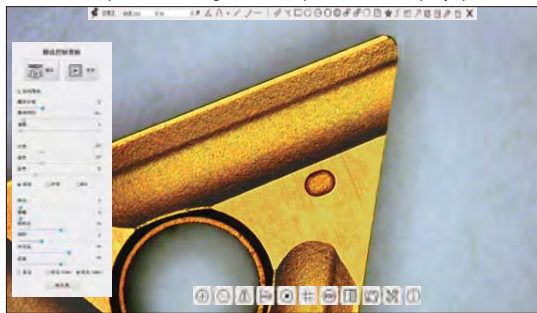

professional measuring software (included, for computers)



24

SPECIFICATION

Sensor	1/1.2" CMOS
Pixel	8M
Resolution	3840×2160, 1920×1080
Single pixel	2.9×2.9µm
Frame rate	60fps@3840×2160 (HDMI) 30fps@3840×2160 (LAN) 30fps@3840×2160 (USB)
Binning	1×1
Exposure	0.04~2000ms
Output	HDMI/USB/LAN
Lens connection	C-mount
Power supply	DC 12V 1A
Dimension (L×W×H)	255×170×90mm
Weight	2kg

CONNECTION

HDMI	comply with HDMI 2.0 standard 4K/1080P automatically switched by display resolution
LAN	H264 encoded video bandwidth adjustment in real time DHCP configuration or manual configuration unicast/multicast configuration
WLAN	connecting 5G WLAN adapter (USB 3.0 interface) in AP/STA mode
USB3.0	connecting USB 3.0 port of PC for video transfer MJPEG format video

To be continued

Continued from previous page

STANDARD DELIVERY

Main unit	1 pc
16G SD card	1 pc
USB mouse	1 pc
HDMI2.0 cable	1 pc
USB3.0 cable	1 pc
USB wlan adapter	1 pc
Wlan cable	1 pc
Glass calibration ruler	1 pc
Calibration plate	1 pc
Software	1 pc
Power adapter	1 pc

OPTIONAL ACCESSORY













16G USB flash disk		IS-USBDISK-16G
Adjustable lens adapter	Ø23.2mm eyepiece tube	ISM-MP-2A075
	Ø31.75mm eyepiece tube	ISM-MP-3A075
Fixed lens adapter	Ø23.2mm eyepiece tube	ISM-MP-2F075
	Ø31.75mm eyepiece tube	ISM-MP-3F075
Adapter ring for Ø30.0mm eyepiece tube		ISM-MP-300R
Adapter ring for Ø30.5mm eyepiece tube		ISM-MP-305R

COMPUTER

Operation system	Windows/7/8/10
CPU	Intel Core 2 2.8Hz
Memory	2GB
USB port	USB 3.0 or USB 2.0 port
Display	17"

PROFESSIONAL MEASURING SOFTWARE (INCLUDED, FOR COMPUTERS)

Measuring tools:

-  measure length of line or distance between two points
-  measure rectangle
-  measure distance between two parallel lines
-  measure width and diameter of ring
-  measure angle
-  measure diameter, length, perimeter angle of arc
-  measure radius, girth and area of circle
-  measure area of polygon
-  measure axis lengths, girth and area of ellipse
-  measure center distance between two circles
-  calibration
-  measure length of open curve

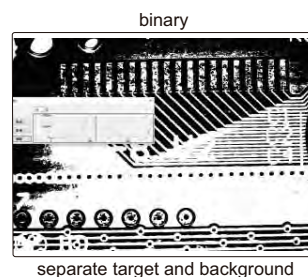
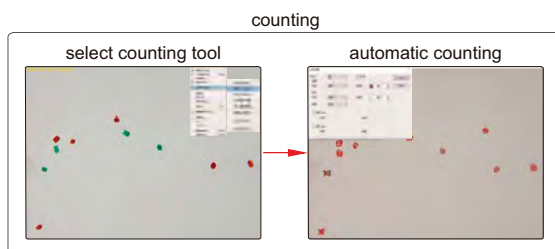
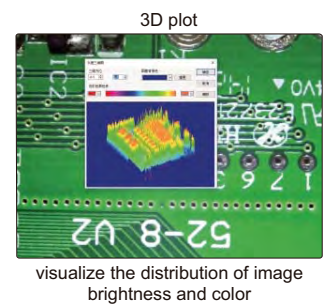
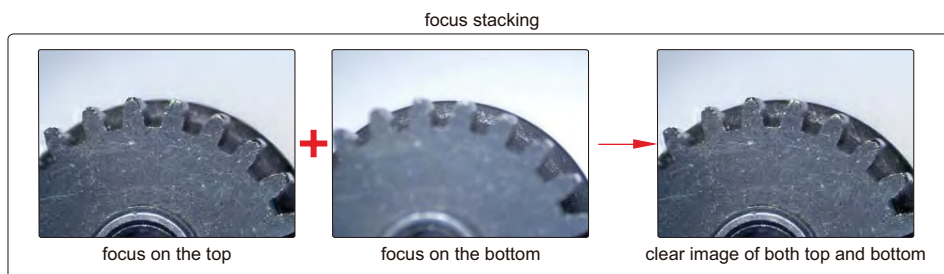
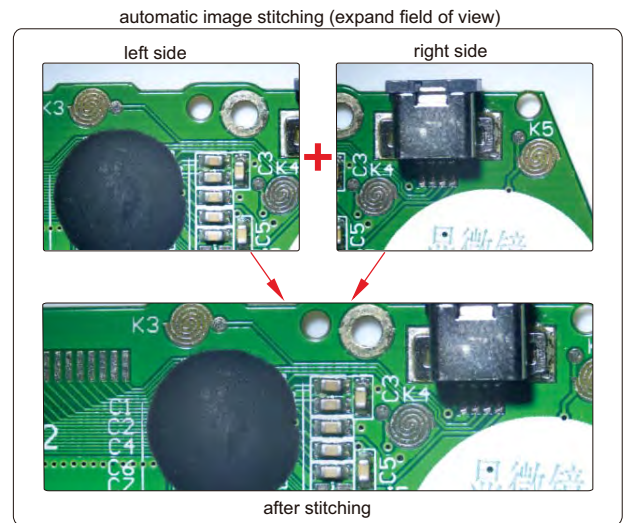

METALLURGICAL ANALYSIS SOFTWARE AND CAMERA CODE ISM-MAS100

- More than 100 standards (ISO, ASTM, JIS, etc.)
- For metallurgical microscopes
- The camera can be inserted into the eyepiece tube or camera connector of microscopes
- Metallurgical analysis software is included, which can make comparative analysis, measurement and evaluation of various materials



application



software flash disk (included)

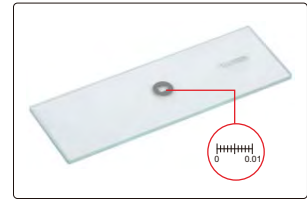

glass calibration rule (included, graduation 0.01mm)

metallurgical analysis software (included)

tool bar

gallery

this software can be used with variety of metallurgical microscopes for acquisition, processing, analysis, report generation of metallurgical images

metallurgical module list

Select autoAnalysis Item

- [M01] METHOD OF AVERAGE GRAIN SIZE AREA OF METAL.....
- [M02] METAL AVERAGE GRAIN SIZE ESTIMATING POINT METHOD.....
- [M03] METAL AVERAGE GRAIN SIZE COMPARISON METHOD.....
- [M04] Details of Average Grain Size Testing for Other Metals and Alloys.....
- [M05] Standard for Dual Grain Size Characterization Test Method Area Fraction Evaluation Comparison Chart.....
- [M06] Standard for Dual Grain Size Characterization Test Method X1. Micrographs of Dual Grain Size Types.....
- [M07] Standard for Dual Grain Size Characterization Test Method X2. Application of Statistical Program for Determining Grain Size Distribution.....
- [M08] Standard for Dual Grain Size Characterization Test Method X3. Application of Statistical Program for Determining Grain Size Distribution.....
- [M09] steel apparent grain size of micrographic estimating(planimetry) EN.....
- [M10] steel apparent grain size of micrographic estimating(transversal method) EN.....
- [M11] Determination of nonmetallic inclusion content in steel by standard grading diagram.....
- [M12] Evaluation Method of Inclusion Content in Steel_method (Worst field of view method).....
- [M13] Evaluation Method of Inclusion Content in Steel_method (Low Inclusion Content Method).....
- [M14] Evaluation Method of Inclusion Content in Steel_method.....
- [M15] Metallurgical examination method. Microscopic examination of non-metallic impurities in high quality steel by metallurgical diagram.....
- [M16] Metallurgical examination of precious metal coprous oxide.....
- [M17] Determination of decarburization depth of steel.....
- [M18] DETERMINATION OF FERRITE GRAIN SIZE OF LOW CARBON STEEL COLD ROLLED SHEET GRAIN Elongation.....
- [M19] Determination of Phase Area Content of Stainless Steel.....
- [M20] Metallurgical Examination of Gray Cast Iron Graphite Distribution Shape.....
- [M21] Metallurgical Examination of Gray Cast Iron Graphite Length (Manual Analysis).....
- [M22] Metallurgical Inspection of Gray Cast Iron Graphite Length (Automatic Analysis).....
- [M23] Metallurgical Examination of Gray Cast Iron Number of Pearlite.....
- [M24] Metallurgical Examination of Gray Cast Iron Number of Carbides.....
- [M25] Metallurgical Examination of Gray Cast Iron Number of Phosphorus Eutectic.....
- [M26] Metallurgical Examination of Gray Cast Iron Determination of the Number of Eutectic Groups of Cast Iron.....
- [M27] Metallurgical examination of gray cast iron Phosphorus eutectic type etc.....
- [M28] Quantitative metallurgical determination.....
- [M29] Free cementite.....
- [M30] Pearlite in Low Carbon Deformed Steel.....
- [M31] Zonal tissue.....
- [M32] Widmanstätten tissue.....
- [M33] Microstructure Assessment of Steel Calculation of Troostite Content.....
- [M34] Metallurgical Martensite Needle Length Rating of Carburized Gear for Automobile.....
- [M35] Metallurgical Carbide Rating of Carburized Gears for Automobile.....
- [M36] Metallurgical Retained Austenite Rating of Carburized Gears for Automobile.....

Multi-module grad [OK] [Cancel]

To be continued

Continued from previous page

examples of metallurgical analysis

metallurgical analysis of ductile cast iron-spheroidizing grading

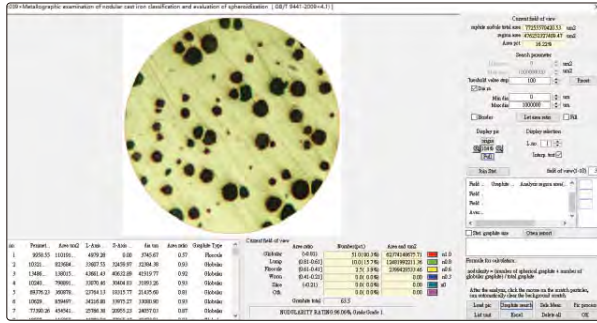

metallurgical analysis of ductile cast iron-pearlite quantity

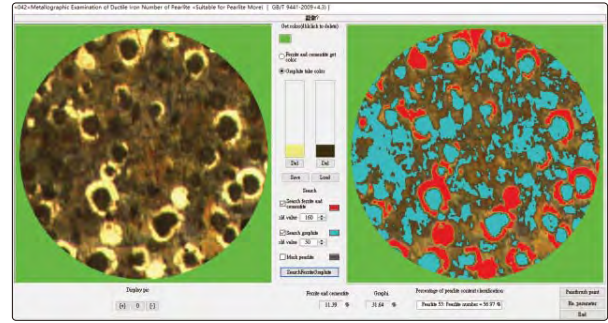

dimension measurement

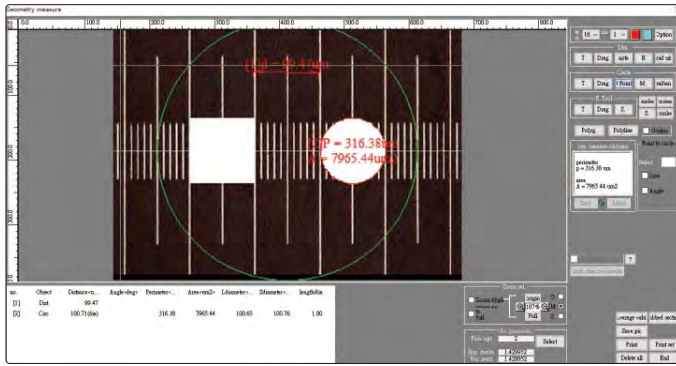

report

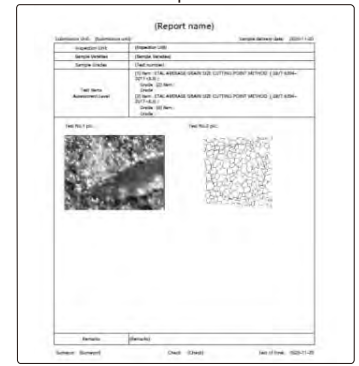

focus stacking

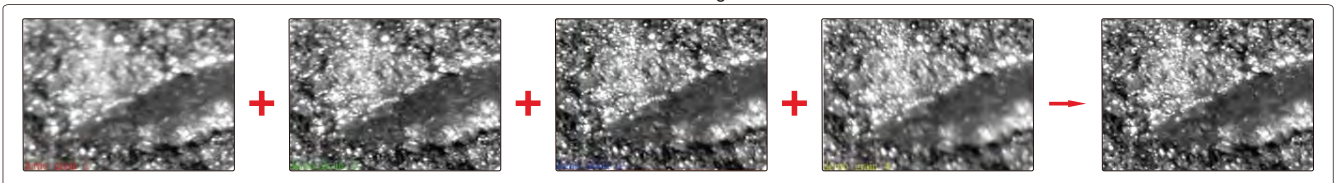
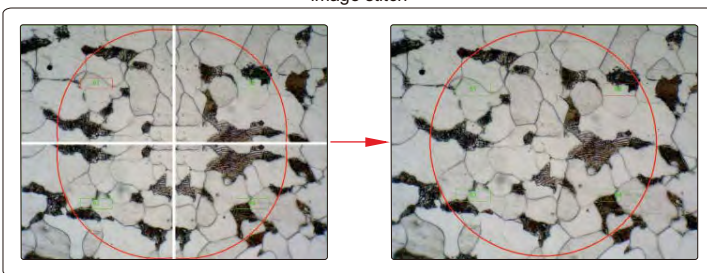
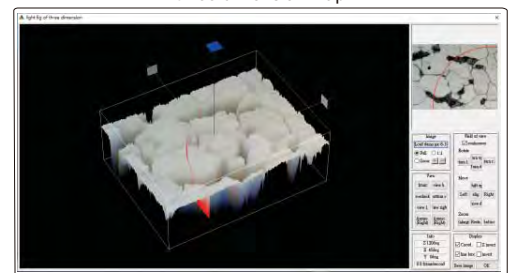

image stitch



three dimension map



SPECIFICATION

Sensor	1/2.8" CMOS
Pixel	3.1µm
Resolution	2048×1536
Frame rate	10fps
Exposure	manual or automatic, adjustable exposure time
Power supply	USB port
Weight	400g

STANDARD DELIVERY

Camera (USB cable included)	1 pc
Software	1 pc
Glass calibration rule (graduation 0.01mm)	1 pc

CAMERA ADAPTERS

- Ø23.2/30mm eyepiece adapter is included
- Suitable for digital cameras ISM-CM20, ISM-CM63, ISM-ZS70-S

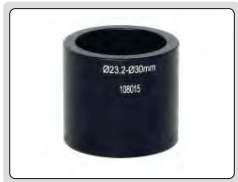

Ø23.2/30mm eyepiece adapter (included)



0.5X camera adapter (fixed focus distance) ISM-AD-0D5



0.75X camera adapter (fixed focus distance) ISM-AD-0D75



0.5X camera adapter (adjustable focus distance) ISM-AD-A0D5



0.75X camera adapter (adjustable focus distance) ISM-AD-A0D75

application

inserted into eyepiece tube



inserted into camera connector



SPECIFICATION

Code	ISM-AD-0D5	ISM-AD-A0D5 *	ISM-AD-0D75	ISM-AD-A0D75
Type	fixed focus distance	adjustable focus distance	fixed focus distance	adjustable focus distance
Magnification	0.5X	0.41X~0.58X	0.75X	0.64X~0.86X

* There may be shadows on the edge of image when ISM-AD-A0D5 is used

PORTABLE MEASURING MICROSCOPES

24



ISM-PM100

SPECIFICATION

Code	ISM-PM20	ISM-PM40	ISM-PM50	ISM-PM100
Total magnification	20X	40X	50X	100X
Eyepiece	10X with graduation	10X with graduation	10X with graduation	10X with graduation
Objective (achromatic)	2X (numerical aperture: 0.05)	4X (numerical aperture: 0.1)	5X (numerical aperture: 0.12)	10X (numerical aperture: 0.25)
Working distance	17.2mm	18mm	17.6mm	7mm
Graduation	0.05mm	0.025mm	0.02mm	0.01mm
Viewing field	Ø9mm	Ø4.5mm	Ø3.6mm	Ø1.8mm
Focus range	30mm			
Illumination	LED light			
Diameter of base	Ø63mm			
Height	210mm			
Weight	650g			

STANDARD DELIVERY

Main unit	1 pc
Pen light	1 pc
Battery (AAA)	2 pcs

TABLE MAGNIFIER WITH ILLUMINATION CODE 7517-3D

- Four steps brightness adjustment
- LED illumination, working life 20000h
- Resin lens

SPECIFICATION

Magnification	1.75X
Diopter	3D
Lens diameter	Ø125mm
Illumination	power: 3W, illumination: 260lm
Power supply	power adapter 12V, 1A



TABLE MAGNIFIERS WITH ILLUMINATION

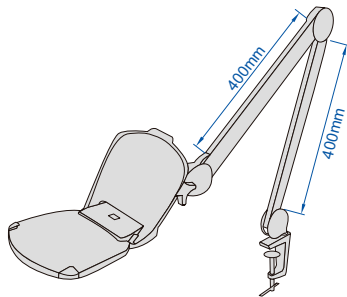

- LED illumination, working life 20000h
- Resin lens

SPECIFICATION

Code	7520-320D	7521-3D
Magnification	two magnifications 1.75X/6X	1.75X
Diopter	3D/20D	3D
Lens dimension	160×127mm	Ø126mm
Illumination	power: 6W, illumination: 550lm	
Power supply	power adapter 12V, 1A	

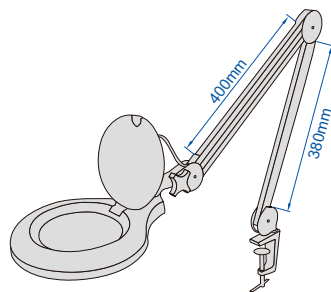

- LED illumination, working life 20000h

SPECIFICATION

Magnification	2.25X
Diopter	5D
Lens diameter	Ø122mm
Illumination	power: 7W, illumination: 420lm
Power supply	100~240V, 50~60Hz

TABLE MAGNIFIER WITH ILLUMINATION CODE 7516-5D



DIGITAL MAGNIFIER CODE 7525-D4



- 720P60 camera
- Auto focus
- With screen freezing function
- 26 color modes can be switched to meet the needs of different people
- Port to TV
- Automatic shutdown after 3 minutes

after the handle is folded, the magnifier can be directly placed on the object for observation



SPECIFICATION

Screen size	4.3 inch
Screen resolution	480x272
Magnification	2X-32X
Pixel	8M
Focus	manual/automatic
Color mode (26 modes)	color mode, color enhancement mode, negative mode, monochrome mode, black on white, white on black, blue on white, white on blue, yellow on black, black on yellow, yellow on blue, blue on yellow, green on white, white on green, orange on white, white on orange, red on black, black on red, orange on black, black on orange, yellow on green, green on yellow, red on white, white on red, yellow on white, white on yellow
Output	TV
Charging port	Type-C
Lithium battery	1600mAH (for 4 hours working)
Dimension (LxWxH)	123x39x76mm (when the handle is folded)
Weight	210g

side and back

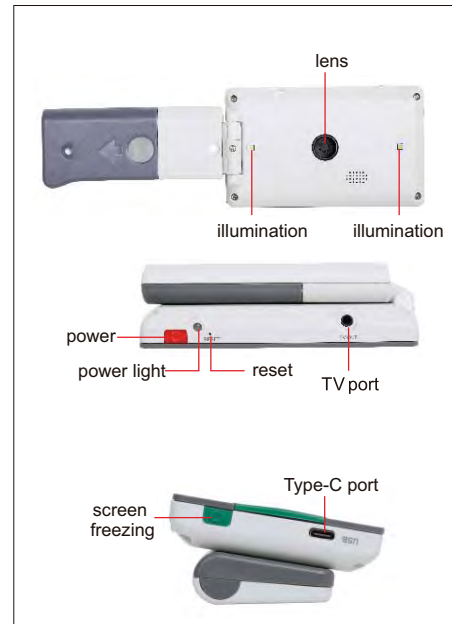

STANDARD DELIVERY

Main unit	1 pc
Video output cable	1 pc
USB charging cable	1 pc
Power adapter	1 pc



DIGITAL MAGNIFIER CODE 7526-D5

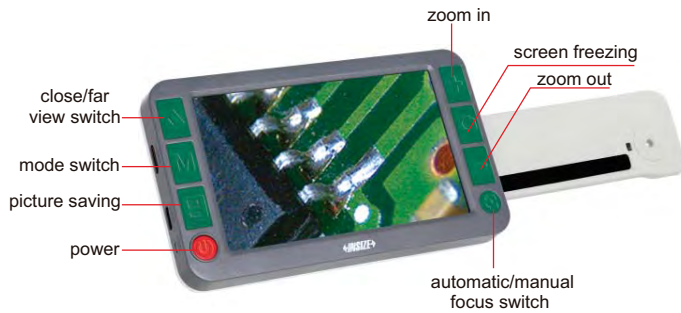

horizontal and vertical red lines

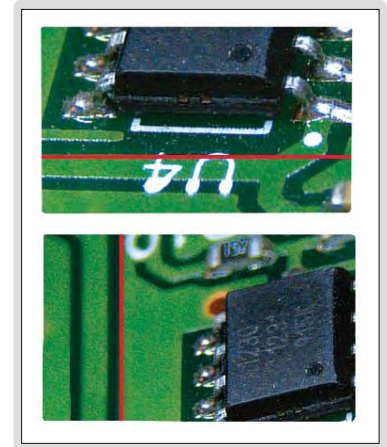

- 720P60 (close view) and 1080P30 (far view) cameras
- Double autofocus
- 26 color modes can be switched to meet the needs of different people
- Adopt folding bracket
- Detachable handle design, suitable for left-handed or right-handed use
- TV and HDMI ports to TV and display
- Automatic shutdown after 3 minutes

SPECIFICATION

Screen size	5 inch
Screen resolution	800x480
Magnification	2X-32X
Close view pixel	8M
Far view pixel	8M
Focus	manual/automatic
Color mode (26 modes)	color mode, color enhancement mode, negative mode, monochrome mode, black on white, white on black, blue on white, white on blue, yellow on black, black on yellow, yellow on blue, blue on yellow, green on white, white on green, orange on white, white on orange, red on black, black on red, orange on black, black on orange, yellow on green, green on yellow, red on white, white on red, yellow on white, white on yellow
Line	horizontal and vertical red lines
Function	screen freezing, image moving, photo playback, and high definition storage
Output	TV and HDMI
Storage	supports up to 32G TF card
Charging port	Type-C
Lithium battery	2500mAH (for 4 hours working)
Dimension (LxWxH)	145x30x85mm (when the handle is folded)
Weight	275g

after the handle is folded, the magnifier can be directly placed on the object for observation



24

side and back

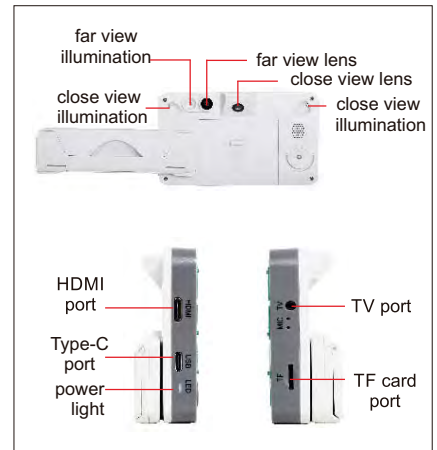

STANDARD DELIVERY

Main unit	1 pc
HDMI cable	1 pc
Video output cable	1 pc
USB charging cable	1 pc
Power adapter	1 pc

FOLDING MAGNIFIER

- Glass lens

Code	Magnification	Lens diameter (ØD)
7511-8	10X	Ø21mm



7511-8

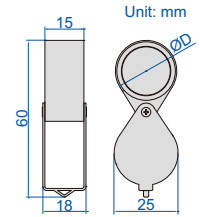

FOLDING MAGNIFIER WITH ILLUMINATION

- Resin lens
- Powered by 3xLR927 batteries (included)

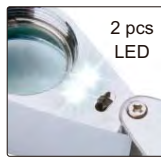

2 pcs LED



7515-10

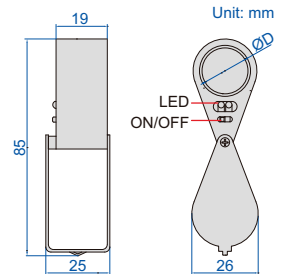

FOLDING MAGNIFIER WITH ILLUMINATION



closed

LED lights up when opened

- Resin lens
- Powered by 2xCR1620 batteries (included)
- LED lights up automatically when opened

Code	Magnification	Lens diameter (ØD)
7514-1	2.5X	Ø45mm



7514-1

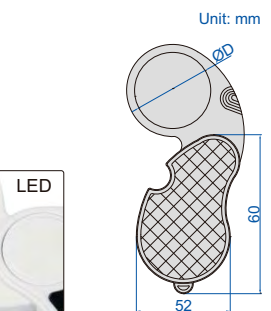

MAGNIFIER WITH ILLUMINATION

- Glass lens
- Powered by 3xAG7 batteries
- 3 pcs LED and 3 pcs UV
- Base with scale, graduation: 0.5mm, 1/16"

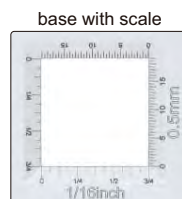

base with scale

rotate lens to adjust focus



7524-10

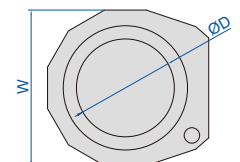
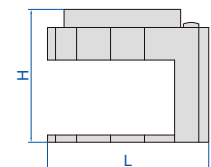

Code	Magnification	Lens diameter (ØD)	L	H	W
7524-10	10X	Ø30mm	60mm	50mm	56mm

MEASURING MAGNIFIERS (WITH ILLUMINATION)

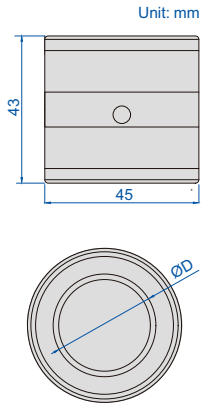

7527-D1

scale of 7527-D1

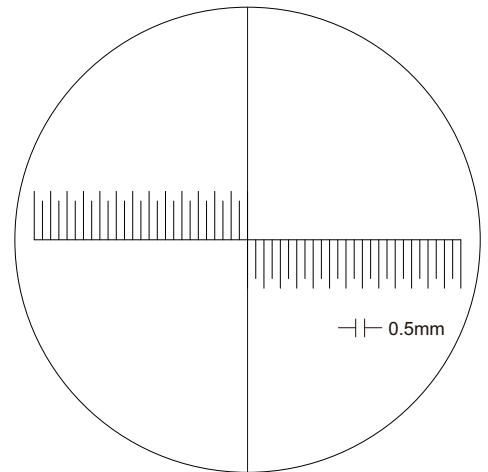

scale of 7527-D2
(0-5mm graduation: 0.1mm, 5-10mm graduation: 0.5mm)

base with scale

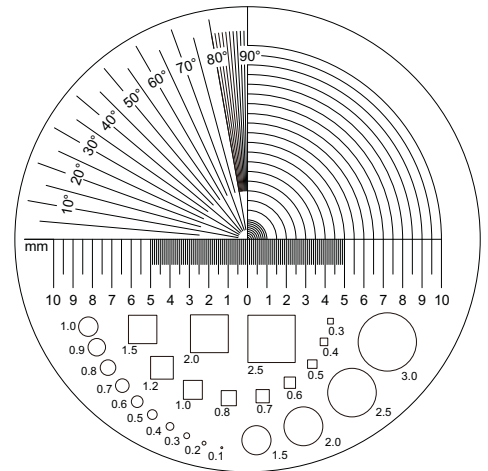
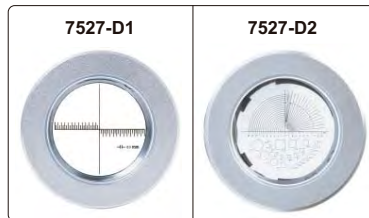

- Base with scale
- With 5 white LED and 5 UV LED
- Charging port: Type-C
- Work for 1.5h after fully charged

Code	Magnification	Lens diameter (ØD)
7527-D1	10X	Ø30mm
7527-D2	10X	Ø30mm

MAGNIFIER WITH ILLUMINATION

- Glass lens
- With 4 white LED, three levels brightness adjustment
- Charging port: Type-C



7528-3

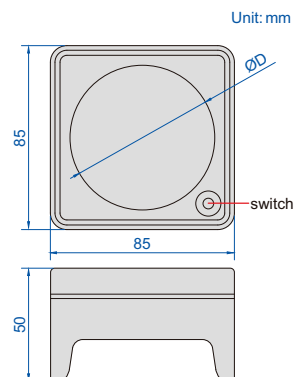

Code	Magnification	Lens diameter (ØD)
7528-3	3X	Ø70mm

MAGNIFIERS WITH ILLUMINATION



- Glass lens
- Powered by 3xAAA batteries (included)



7513-2

7513-4

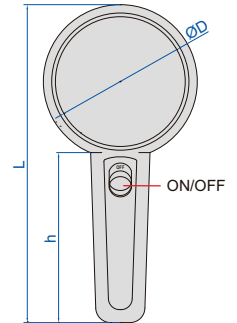

Code	Magnification	Lens diameter (ØD)	L	h
7513-2	2X	Ø75mm	170mm	90mm
7513-4	4X	Ø50mm	145mm	90mm

MAGNIFIER WITH ILLUMINATION

- Resin lens
- With 20 white LED, three levels brightness adjustment
- Charging port: Type-C



7529-24

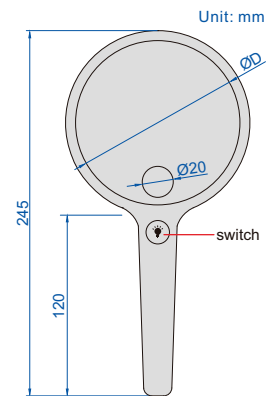

Code	Magnification	Lens diameter (ØD)
7529-24	2X/4X	Ø105mm

MAGNIFIER WITH TWO LENSES

- Resin lens
- Interchangeable lenses
- Powered by 3 pcs AAA batteries (included)



7522-610

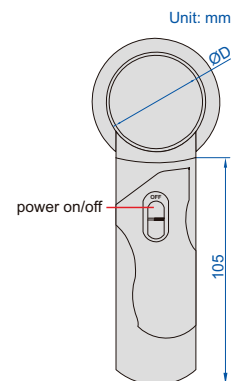

Code	Lens number	Magnification	Lens diameter (ØD)
7522-610	2 pcs	6X	50mm
		10X	37mm

MAGNIFIER WITH ILLUMINATION



LED



foldable handle

- Two magnifications
- LED illumination
- Powered by 2 pcs AAA batteries (included)
- Resin lens

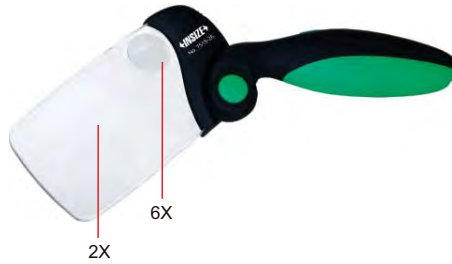

7518-26

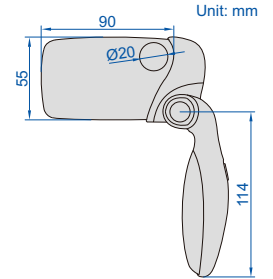

Unit: mm

Code	Magnification	Lens size
7518-26	2X/6X	90x55mm

THREE WAYS MAGNIFIER WITH ILLUMINATION

three ways use



battery house

power adapter

10 pcs LED

- Resin lens
- Powered by 2xAA batteries (included) or power adapter (110~240V, 50~60Hz)



7512-1

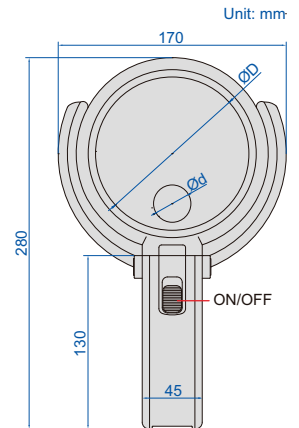

Unit: mm

Code	Magnification	Lens diameter (ØD/Ød)
7512-1	2X/4X	Ø120mm/Ø28mm

MAGNIFIER

using on table



hanging around neck



- Resin lens
- Silicone hose can be shaped according to needs
- Can be used on table or hanging around neck



7530-1D8

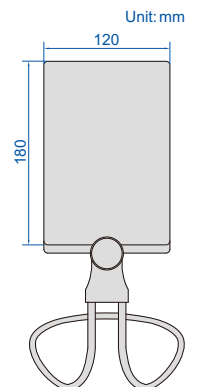

Unit: mm

Code	Magnification	Lens size
7530-1D8	1.8X	180x120mm

MAGNIFICATION GLASSES

interchangeable lenses



head band (included)



7523-3D5



adjustable lens and LED angle

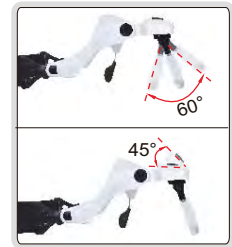

- Resin lens
- Interchangeable lenses
- Powered by 3 pcs AAA batteries (included)

Code	Lens number	Magnification
7523-3D5	5 pcs	1X
		1.5X
		2X
		2.5X
		3.5X

adjustable holder angle



moveable lens for focus



2 pcs LED



TELESCOPING INSPECTION MIRRORS

- Inspect hidden areas
- Rotation of the mirror: 360°
- Length of handle is adjustable, handle is made of stainless steel

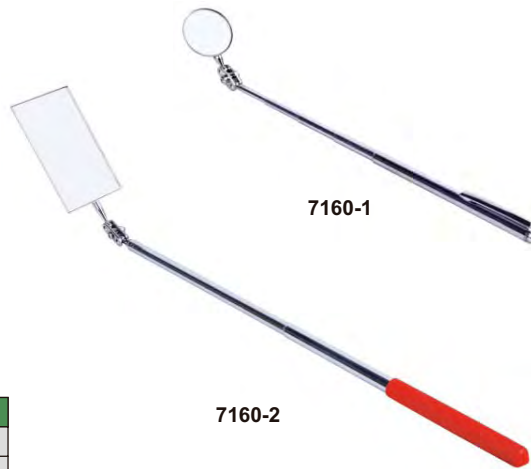

Code	Size of mirror	Length
7160-1	Ø32mm	178~515mm
7160-2	50x90mm	330~490mm

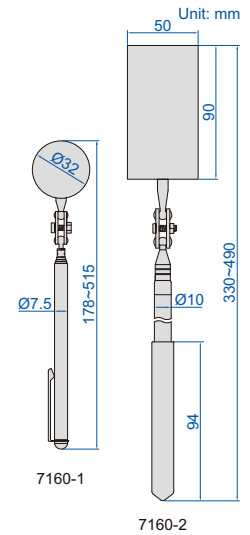

TELESCOPING INSPECTION MIRROR (WITH ILLUMINATION)

- Inspect hidden areas
- Head can bend and rotate
- Telescoping handle, made of stainless steel
- With two CR2032 batteries

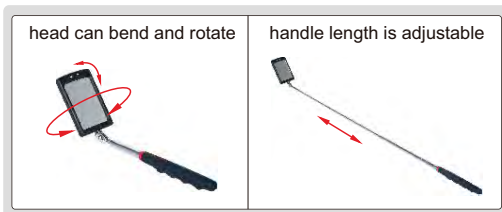

Code	Size of mirror	Length
7162-1	65x42mm	285~875mm



7162-1

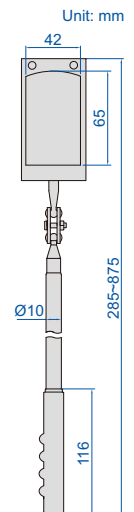

TELESCOPING MAGNETIC PICK-UP AND FLASHLIGHT



- For illumination and pick up steel parts in hidden areas
- Head can bend
- Telescoping handle, made of stainless steel
- Magnetic head and end
- With four LR44 batteries

7163-1

Code	Magnetic force of the end	Magnetic force of the head	Flashlight range	Battery life	Length
7163-1	4kgf	2kgf	3m	8h	172~568mm

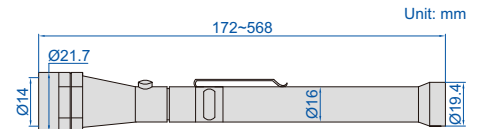

FLEXIBLE PICK-UP AND FLASHLIGHT

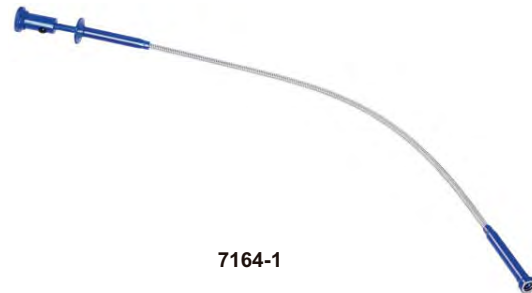
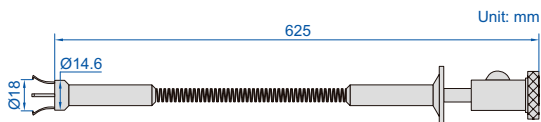

7164-1

- For illumination and pick up steel parts in hidden areas
- Flexible spring rod, made of stainless steel
- Three LR44 batteries

Code	Magnetic force	Flashlight range	Battery life
7164-1	0.9kgf	1m	24h

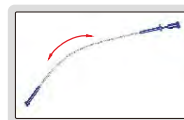

TELESCOPING MAGNETIC PICK-UP

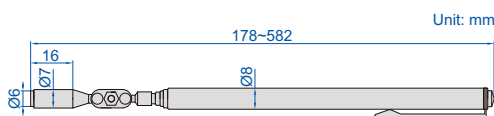

7161-1

- Pick up steel parts from hidden areas
- Rotation of magnetic head: 360°
- Length of handle is adjustable, handle is made of stainless steel

Code	Size of magnetic tip	Magnetic force	Length
7161-1	Ø6mm	0.45kgf	178~582mm



Videoscopes
Page 597-609



Pipe Videoscopes
Page 610



Rigid Borescopes
Page 611

REAR FIBER ILLUMINATION

VIDEOSCOPE (DESK TYPE)

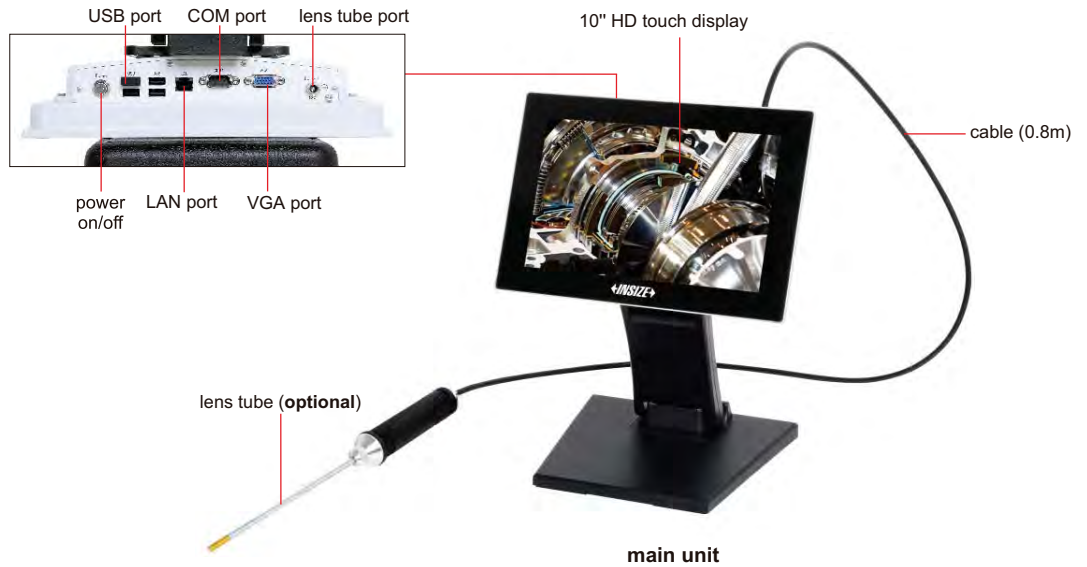

MAIN UNIT (WITHOUT LENS TUBE)

Code	ISV-Y
Display	10" HD touch display
Function	take picture, take video
File format	picture: JPG, video: MP4
Memory	built-in hard disk or USB flash disk
Image process	image zoom (1X, 2X, 3X)
Image control	noise reduction, negative film, flip over, freeze, on-line edit
Illumination	stepless adjustment
Additional function	real-time dynamic annotation, real-time watermark, rapid defect mark
Output	USB, HDMI
Power supply	AC/DC adapter (for continuous working)
Weight	1000g

STANDARD DELIEVERY

Main unit	1 pc
USB disk	1 pc
Mouse	1 pc
AC/DC adapter	1 pc

OPTIONAL ACCESSORY

Lens tube	refer to below details
Software for automatic defect identification	can be customized

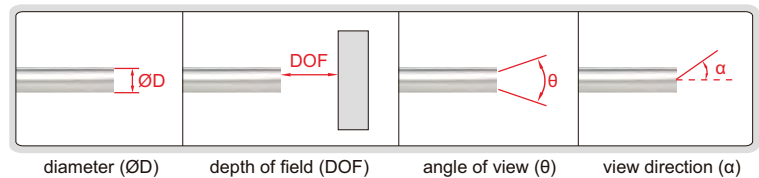

RIGID STRAIGHT LENS TUBE, FRONT VIEW

Code	Lens tube		Lens					
	diameter (ØD)	length (L)	pixel	illumination	angle of view (θ)	depth of field (DOF)	view direction (α)	dust/ waterproof
ISV-Y1210	1.2mm	90mm	0.04M	rear optical fiber	120°	3~70mm	0°	IP67
ISV-Y1810	1.8mm	120mm (optional 90-150mm)	0.16M			3~70mm	0°	
ISV-Y2010	2.0mm	120mm (optional 90-150mm)	0.16M			3~70mm	0°	
ISV-Y2410	2.4mm	150mm (optional 90-300mm)	0.16M			3~70mm	0°	
ISV-Y2810	2.8mm	150mm (optional 90-300mm)	0.16M			3~70mm	0°	
ISV-Y3910	3.9mm	200mm (optional 90-500mm)	1M			8~150mm	0° (optional 30°, 70°)	
ISV-Y6010	6.0mm	300mm (optional 90-1000mm)	1M	12~200mm	0° (optional 30°, 70°)			

To be continued

Continued from previous page

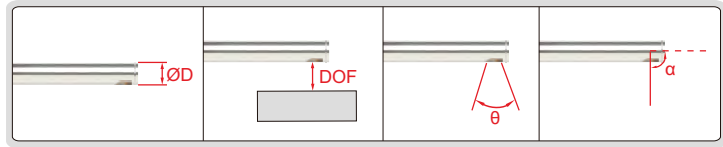

diameter (ØD) depth of field (DOF) angle of view (θ) view direction (α)

RIGID STRAIGHT LENS TUBE, SIDE VIEW

Code	Lens tube		Lens					
	diameter (ØD)	length (L)	pixel	illumination	angle of view (θ)	depth of field (DOF)	view direction (α)	dust/ waterproof
ISV-Y2810C	2.8mm	150mm (optional 90-300mm)	0.16M	rear optical fiber	120°	3~70mm	90°	IP67
ISV-Y3910C	3.9mm	200mm (optional 90-500mm)	1M			8~150mm		
ISV-Y4510C	4.5mm	250mm (optional 90-800mm)	1M			8~150mm		
ISV-Y6010C	6.0mm	300mm (optional 90-1000mm)	1M			12~200mm		

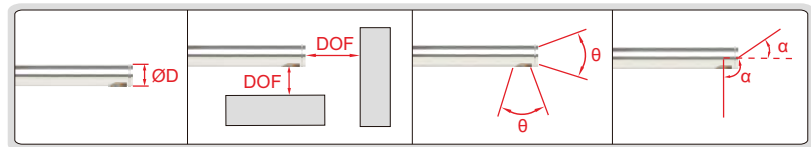

diameter (ØD) depth of field (DOF) angle of view (θ) view direction (α)

RIGID STRAIGHT LENS TUBE, FRONT VIEW & SIDE VIEW

Code	Lens tube		Lens					
	diameter (ØD)	length (L)	pixel	illumination	angle of view (θ)	depth of field (DOF)	view direction (α)	dust/ waterproof
ISV-Y6010S	6.0mm	300mm (optional 90-1000mm)	1M	rear optical fiber	120°	front view: 12~200mm side view: 8~150mm	front view: 0° side view: 90°	IP67

25

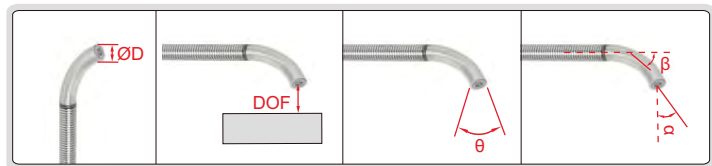

diameter (ØD) depth of field (DOF) angle of view (θ) view direction (α)
bending angle (β)

BENDING SPRING LENS TUBE

Code	Lens tube		Lens						
	diameter (ØD)	length (L)	pixel	illumination	angle of view (θ)	depth of field (DOF)	view direction (α)	bending angle (β)	dust/ waterproof
ISV-Y3010W	3.0mm	1000mm	0.16M	rear optical fiber	120°	8~150mm	0°	75° (can be customized)	IP65
ISV-Y5010W	5.0mm		1M			8~150mm			
ISV-Y7010W	7.0mm		1M			12~200mm			

REAR FIBER ILLUMINATION

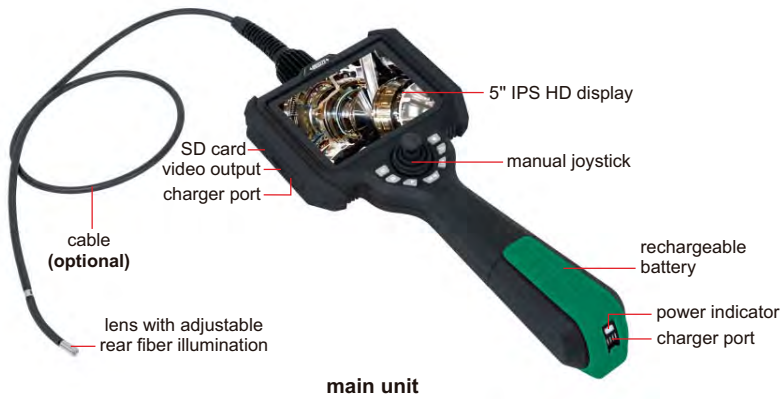

VIDEOSCOPE



changeable lens cable



tripod (included)



ISV-L-HOOK (optional)



ISV-L-MAGNET (optional)



ISV-L-CLAMP (optional)

MAIN UNIT (WITHOUT CABLE)

Code	ISV-L
Display	5" high definition LCD
Resolution	1024×720
Function	take pictures, take videos
File format	picture: JPG, video: MP4
Image process	image zoom (1X, 2X, 3X, 4X)
Image control	freeze, flip over, playback and analog ruler
Memory	memory card
Output	USB, HDMI
Power supply	rechargeable lithium battery (working time ≥ 4hours) AC/DC adapter (for continuous working)
Weight	1000g



OPERATION ENVIRONMENT

Main unit	-10~50°C, no preheat
Operation temperature	-20~70°C
Storage temperature	-20~60°C
Relative humidity	maximum 90%, no condensation

STANDARD DELIVERY

Main unit	1 pc
32G SD card	1 pc
Card reader	1 pc
USB cable	1 pc
Tripod	1 pc
AC/DC adapter	1 pc

OPTIONAL ACCESSORY

Cable	please refer to details
WIFI output	ISV-L-WIFI (must be installed in factory, only for Android OS)
Temperature alarm	ISV-L-HTALARM (must be installed in factory, for Ø3.9mm, Ø4.5mm and Ø6.0mm)
Hook	ISV-L-HOOK (must be installed in factory, for Ø3.9mm, Ø4.5mm and Ø6.0mm)
Magnet	ISV-L-MAGNET (must be installed in factory, for Ø3.9mm, Ø4.5mm and Ø6.0mm)
Clamp	ISV-L-CLAMP

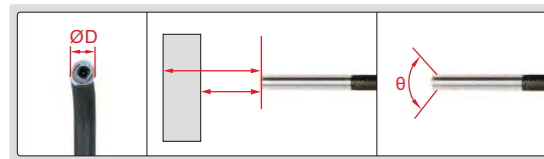

diameter (ØD) depth of field (DOF) angle of view (θ)

ONE-DIRECTION CABLE (NO BENDING), FRONT VIEW

Code	Cable		Lens							
	length	type	view direction	diameter (ØD)	depth of field (DOF)	angle of view (θ)	illumination	pixel	resolution	dust/ waterproof
ISV-L09505	0.5m	spring tube	front view	0.95mm	3~30mm	>120°	rear fiber	0.16M	400×400	IP65
ISV-L09510	1m			1.2mm	3~30mm					
ISV-L1210	1m			1.5mm	3~70mm					
ISV-L1510	1m	tungsten wire weaved cable								
ISV-L1515	1.5m									

To be continued

Continued from previous page

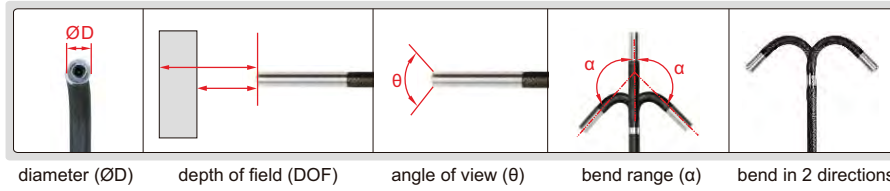

TWO-DIRECTION BENDING CABLE, FRONT VIEW

Code	Cable		Lens									
	length	type	view direction	bend direction	diameter (ØD)	depth of field (DOF)	bend range (α)	angle of view (θ)	illumination	pixel	resolution	dust/ waterproof
ISV-L1810	1m	tungsten wire weaved cable	front view	two directions	1.8mm	3~30mm	±160°	>120°	rear fiber	0.16M	400×400	IP65
ISV-L2010	1m				2.0mm	3~30mm						
ISV-L2410	1m				2.4mm	3~70mm						
ISV-L2415	1.5m				(optional 5~100mm)							
ISV-L2420	2m											

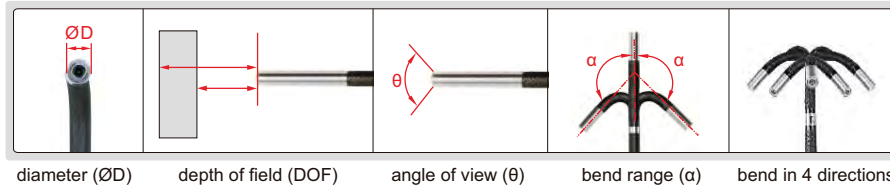

FOUR-DIRECTION BENDING CABLE, FRONT VIEW

Code	Cable		Lens									
	length	type	view direction	bend direction	diameter (ØD)	depth of field (DOF)	bend range (α)	angle of view (θ)	illumination	pixel	resolution	dust/ waterproof
ISV-L2810	1m	tungsten wire weaved cable	front view	four directions	2.8mm	3~70mm	±160°	>120°	rear fiber	0.16M	400×400	IP65
ISV-L2815	1.5m					(optional 5~100mm)						
ISV-L2820	2m											
ISV-L2830	3m				3.9mm	8~150mm				0.92M	1280×720	IP67
ISV-L3910	1m					(optional 3~70mm)						
ISV-L3915	1.5m											
ISV-L3920	2m				6.0mm	12~200mm				0.92M	1280×720	IP67
ISV-L3930	3m					(optional 3~70mm, 8~150mm)						
ISV-L3940	4m											
ISV-L3950	5m											
ISV-L6010	1m											
ISV-L6015	1.5m											
ISV-L6020	2m											
ISV-L6030	3m											
ISV-L6040	4m											
ISV-L6050	5m											
ISV-L6060	6m											
ISV-L6070	7m											

To be continued

Continued from previous page

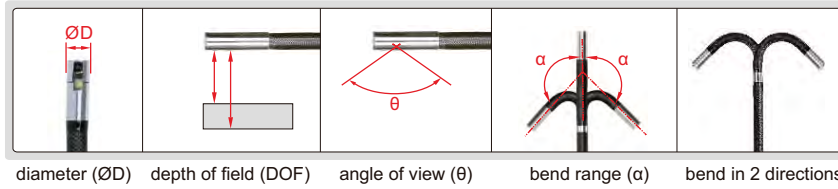

TWO-DIRECTION BENDING CABLE, SIDE VIEW

Code	Cable		Lens									
	length	type	view direction	bend direction	diameter (ØD)	depth of field (DOF)	bend range (α)	angle of view (θ)	illumination	pixel	resolution	dust/ waterproof
ISV-L1810C	1m	tungsten wire weaved cable	side view	two directions	1.8mm	3~30mm	±160°	>120°	rear fiber	0.16M	400×400	IP65
ISV-L1815C	1.5m											

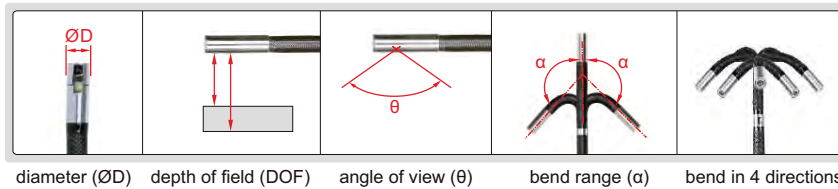

FOUR-DIRECTION BENDING CABLE, SIDE VIEW

Code	Cable		Lens									
	length	type	view direction	bend direction	diameter (ØD)	depth of field (DOF)	bend range (α)	angle of view (θ)	illumination	pixel	resolution	dust/ waterproof
ISV-L2810C	1m	tungsten wire weaved cable	side view	four directions	2.8mm	3~70mm	±160°	>120°	rear fiber	0.16M	400×400	IP65
ISV-L2815C	1.5m											
ISV-L2820C	2m											
ISV-L2830C	3m											
ISV-L4510C	1m				4.5mm	5~100mm (optional 8~150mm)				0.92M	960×720	IP67
ISV-L4515C	1.5m											
ISV-L4520C	2m											
ISV-L4530C	3m											
ISV-L6010C	1m											
ISV-L6015C	1.5m				6.0mm	8~150mm (optional 5~100mm)						
ISV-L6020C	2m											
ISV-L6030C	3m											
ISV-L6040C	4m											
ISV-L6050C	5m											

FRONT AND SIDE VIEW VIDEOSCOPE

REAR FIBER ILLUMINATION

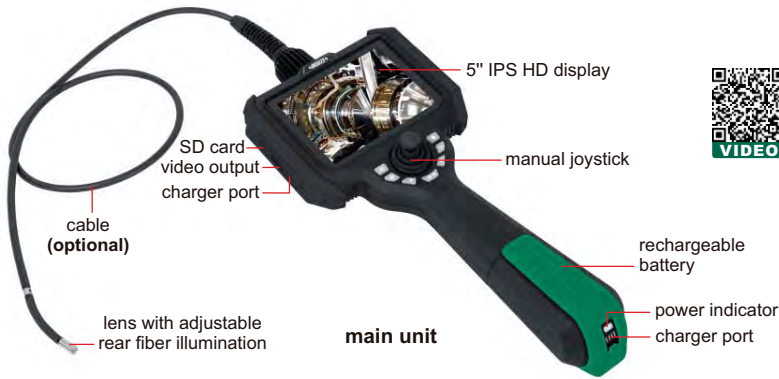

MAIN UNIT (WITHOUT CABLE)

Code	ISV-S
Display	5" high definition LCD
Resolution	1024×720
Function	take pictures, take videos
File format	picture: JPG, video: Mp4
Image process	image zoom (1X, 2X, 3X, 4X)
Image control	freeze, flip over, playback and analog ruler
Memory	memory card
Output	USB, HDMI
Power supply	rechargeable lithium battery (working time ≥ 4hours) AC/DC adapter (for continuous working)
Weight	1000g



changeable lens cable



tripod (included)



ISV-S-CLAMP (optional)



ISV-S-HOOK (optional)



ISV-S-MAGNET (optional)

STANDARD DELIEVERY

Main unit	1 pc
32G SD card	1 pc
Card reader	1 pc
USB cable	1 pc
Tripod	1 pc
AC/DC adapter	1 pc

OPTIONAL ACCESSORY

Cable	please refer to details
WIFI output	ISV-S-WIFI (must be installed in factory, only for Android OS)
Temperature alarm	ISV-S-HTALARM (must be installed in factory)
Hook	ISV-S-HOOK (must be installed in factory)
Magnet	ISV-S-MAGNET (must be installed in factory)
Clamp	ISV-S-CLAMP

OPERATION ENVIRONMENT

Main unit	-10~50°C, no preheat
Operation temperature	-20~70°C
Storage temperature	-20~60°C
Relative humidity	maximum 90%, no condensation

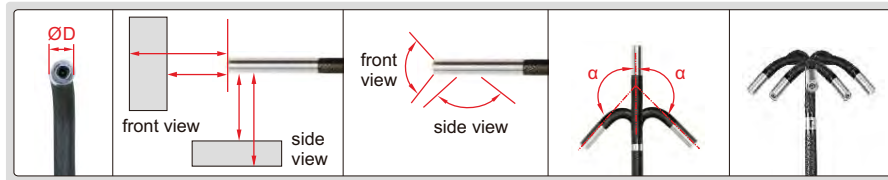

diameter (ØD) depth of field (DOF) angle of view (θ) bend range (α) bend in 4 directions

FOUR-DIRECTION BENDING CABLE, FRONT VIEW&SIDE VIEW

Code	Cable		Lens									
	length	type	view direction	bend direction	diameter (ØD)	depth of field (DOF)	bend range (α)	angle of view (θ)	illumination	pixel	resolution	dust/ waterproof
ISV-S6010	1m	tungsten wire weaved cable	front view and side view	four directions	6.0mm	front view: 12~200mm (optional) 3~70mm side view: 8~150mm (optional) 3~70mm	±160°	>120°	rear fiber	0.92M	1280×720	IP67
ISV-S6015	1.5m											
ISV-S6020	2m											
ISV-S6030	3m											
ISV-S6040	4m											
ISV-S6050	5m											

VIDEOSCOPES



changeable lens cable

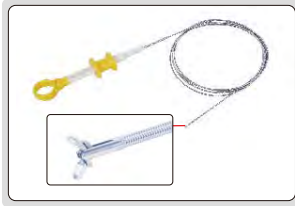

ISV-K-CLAMP (optional)



ISV-K-HOOK (optional)



ISV-K-MAGNET (optional)

REAR FIBER ILLUMINATION

tungsten wire weaved cable length: 1.5m

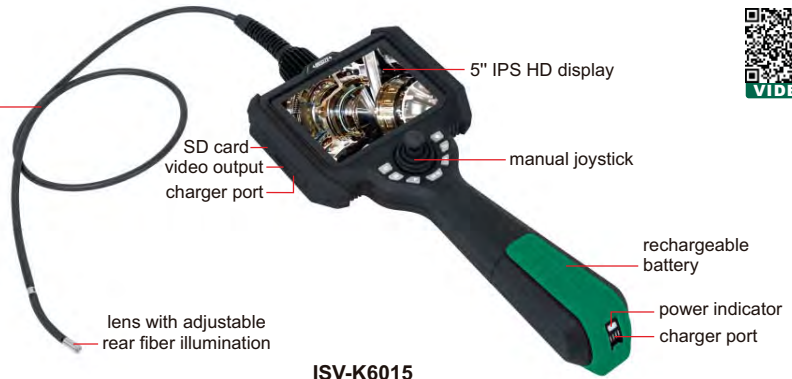

ISV-K6015

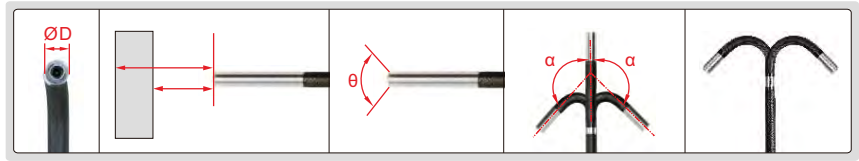

diameter (ØD)

depth of field (DOF)

angle of view (θ)

bend range (α)

bend

SPECIFICATION

Code	ISV-K1810	ISV-K2410	ISV-K2810	ISV-K3915	ISV-K6015	
Lens	diameter (ØD)	1.8mm	2.4mm	2.8mm	3.9mm	6.0mm
	pixel	0.16M			0.92M	
	resolution	400×400			1280×720	
	depth of field	3-30mm	3-70mm	3-70mm	8-150mm	12-200mm
	bending direction	two directions	two directions	four directions	four directions	four directions
	bending range (α)	±160°				
	angle of view (θ)	120°				
	illumination	rear fiber				
	lens	sapphire glass lens				
	dust/waterproof	IP65			IP67	
Cable	bend control	manual joystick				
	length	1m	1m	1m	1.5m	1.5m
Main unit	type	tungsten wire weaved cable				
	display	5" high definition LCD				
	function	take pictures, take videos				
	file format	picture: JPG, video: MP4				
	image process	image zoom (1X, 2X, 3X, 4X)				
	image control	freeze, flip over, playback and analog ruler				
	memory	memory card				
output	USB, HDMI					
power supply	rechargeable lithium battery (working time ≥ 4 hours), AC/DC adapter (for continuous working)					
Weight	1000g					

STANDARD DELIVERY

Main unit	1 pc
32G SD card	1 pc
Card reader	1 pc
USB cable	1 pc
Tripod	1 pc
AC/DC adapter	1 pc

OPERATION ENVIRONMENT

Main unit	-10~50°C, no preheat
Operation temperature	-20~70°C
Storage temperature	-20~60°C
Relative humidity	maximum 90%, no condensation

OPTIONAL ACCESSORY

WIFI output	ISV-K-WIFI (must be installed in factory, only for Android OS)
Temperature alarm	ISV-K-HTALARM (must be installed in factory, for ISV-K3915 and ISV-K6015)
Hook	ISV-K-HOOK (must be installed in factory, for ISV-K3915 and ISV-K6015)
Magnet	ISV-K-MAGNET (must be installed in factory, for ISV-K3915 and ISV-K6015)
Clamp	ISV-K-CLAMP

MOBILE PHONE VIDEOSCOPE CODE ISV-P6



the clamping range of mobile phone bracket L=56-95mm

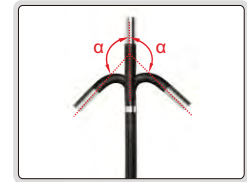

bending of lens up to 180°

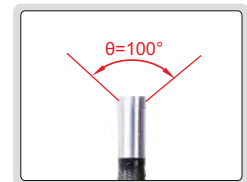

angle of view



lens with LED

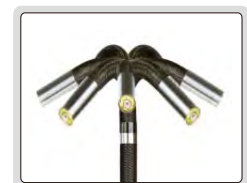

bend in any direction

■ For Android and IOS mobile phones

SPECIFICATION

Diameter of lens (ØD)	6±0.2mm
Length of cable	1m
Resolution	960×720, 1280×720 (switchable)
Depth of field	20mm~∞
Angle of view (θ)	100°
Bending range (α)	0~180°
Illumination	LED with 3 levels control
Cable type	wear resistant
Interface	USB, Type-C
Mobile phone system	Android, IOS
Power supply	rechargeable battery (for 2 hours working)
Dimension (L×W×H)	195×57×105mm
Weight	450g

STANDARD DELIVERY

Main unit (with cable)	1 pc
Type-C cable	1 pc
Micro USB cable	1 pc
Iphone cable	1 pc
Charging cable	1 pc

TUNGSTEN WIRE WEAVED CABLE
BREAK AND WEAR RESISTANCE

VIDEOSCOPES (BASIC TYPE)



ISV-S106

SPECIFICATION

Code		ISV-T105	ISV-S106
Lens	diameter (ØD)	6mm	
	pixel	1M	
	resolution	1280×720	
	depth of field	20~150mm	
	bending direction	360°	
	bending range (α)	0°~220°	
	angle of view (θ)	120°	
	illumination	7 pcs LED, with 6 levels control	
	illuminance	25000 Lux	
	lens	sapphire glass lens	
	dust/waterproof	IP67	
	bend control	manual joystick	
temperature alarm	temperature sensor (optional)		
Cable	length	1m	1.5m
	type	tungsten wire weaved cable	
Main unit	display	3.5" IPS full-view display	
	display resolution	640×480	
	function	take pictures, take videos	
	file format	picture: JPG, video: MP4	
	image process	image zoom (1X, 2X, 3X, 4X, 5X)	
	memory	memory card (Maximum: 64G)	
	output	USB, HDMI, WIFI (optional)	
	dust/waterproof	IP65	
	power supply	rechargeable lithium battery (working time ≥ 3 hours; optional: additional battery, working time ≥ 9 hours) AC/DC adapter (for continuous working)	
Weight	1000g		

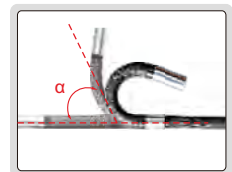

220° bending angle

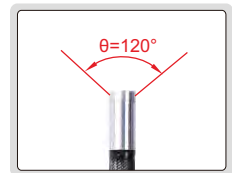

120° view angle



LED 6 levels control



360° bending direction

STANDARD DELIVERY

Main unit (with cable & lens)	1 pc
16G SD card	1 pc
Card reader	1 pc
USB cable	1 pc
Battery	1 pc
AC/DC adapter	1 pc

OPTIONAL ACCESSORY

Additional battery	ISV-S106-BATTERY (must be installed in factory)
WIFI output	ISV-S106-WIFI
Temperature alarm	ISV-S106-HT-ALARM

VIDEOSCOPE (BASIC TYPE) CODE ISV-E40

MEMORY CABLE CAN
BE FIXED AT ANY SHAPE

IP67
WATERPROOF



magnet pick up (included)



hook (included)



45° mirror (included)

SPECIFICATION

Lens	diameter (ØD)	8mm
	pixel	0.92M
	resolution	1280x720
	depth of field	30~80mm
	angle of view	77°
	illumination	3 levels
	dust/waterproof	IP67
Cable	length	1180mm
	type	memory (can be set at any shape)
Main unit	display	5" IPS LCD
	function	take picture, take video
	file format	picture: JPG, video: MOV
	image process	image zoom (1.5X, 2X, 3X, 4X)
	memory	memory card (optional)
	output	Type-C
	power supply	rechargeable lithium battery (for 5 hours working)
dimension	217×155×131mm	
Weight	506g	

STANDARD DELIVERY

Main unit	1 pc
45° mirror	1 pc
Hook	1 pc
Magnet pick up	1 pc

OPTIONAL ACCESSORY

32G memory card	ISV-E40-CARD
Card reader	ISV-E40-READER

OPERATION ENVIRONMENT

Operation temperature	-10~50°C
Storage temperature	-20~60°C
Operation humidity	15%~85%

MEMORY CABLE CAN BE FIXED AT ANY SHAPE

IP67
WATERPROOF



VIDEOSCOPE (ECONOMIC TYPE)
CODE ISV-E30

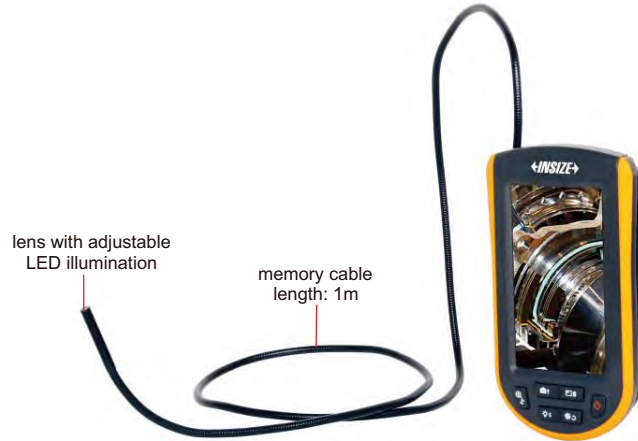

magnet pick up (included)



hook (included)



cable can be wrapped around the main unit

SPECIFICATION

Lens	diameter	5.2mm
	pixel	0.4M
	depth of field	30~80mm
	angle of view	72°
	illumination	8 levels
	dust/waterproof	IP67
Cable	length	1m
	type	memory (can be set at any shape)
Main unit	display	4.3" LCD
	function	take picture, take video
	file format	picture: JPG, video: AVI
	image zoom	2X
	memory card	memory card (optional)
	output	micro USB
	power supply	AA battery
dimension	154×32.5×87.5mm	
Weight		280g

STANDARD DELIVERY

Main unit	1 pc
Hook	1 pc
Magnet pick up	1 pc
AA battery	4 pcs

OPTIONAL ACCESSORY

32G memory card	ISV-E40-CARD
Card reader	ISV-E40-READER

OPERATION ENVIRONMENT

Operation temperature	-10~50°C
Storage temperature	-20~60°C
Operation humidity	15%~85%

MULTIPURPOSE VIDEOSCOPE

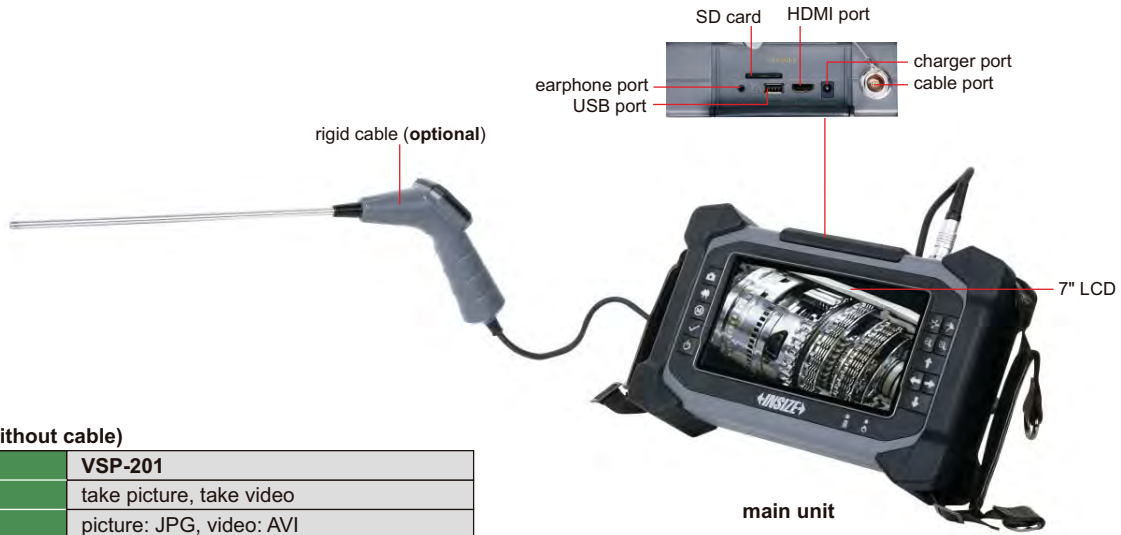

MAIN UNIT (without cable)

Code	VSP-201
Function	take picture, take video
File format	picture: JPG, video: AVI
Image process	brightness, contrast
Memory	64GB
Output	HDMI, USB
Power supply	rechargeable battery (for 4 hours working)
Dimension	260×170×65mm
Weight	1.2kg

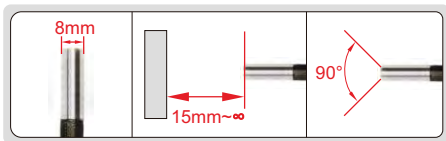

diameter (ØD) focus distance (F) angle of view (θ)



bend in any direction 360° swivel in clockwise and counter-clockwise bend within 120°



FOUR-DIRECTION BENDING CABLE (FRONT VIEW)

Code	VSP-201D	
Cable	length	3m
	type	tungsten wire weaved cable
Lens	diameter (ØD)	8mm
	focus distance (F)	15mm~∞
	angle of view (θ)	90°
	illumination	6 pcs LED
	pixel	1M
	resolution	1280×720
dust/waterproof		IP67



To be continued

Continued from previous page

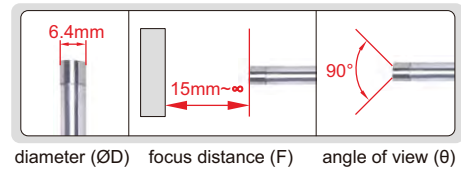

RIGID CABLE

Code	VSP-201H	
Cable	length (L)	250mm
	type	stainless steel
Lens	diameter (ØD)	6.4mm
	focus distance (F)	15mm~∞
	angle of view (θ)	90°
	illumination	6 pcs LED
	pixel	1M
	resolution	1280×720
dust/waterproof		IP64

ROTATING LENS CABLE

Code	VSP-201R	
Cable	length	30m
	type	high strength glass fibre
Lens	diameter (ØD)	40mm
	focus distance (F)	3mm~∞
	angle of view (θ)	100°
	illumination	12 pcs LED
	pixel	1M
	resolution	1280×720
	dust/waterproof	IP67
lens control		motorized

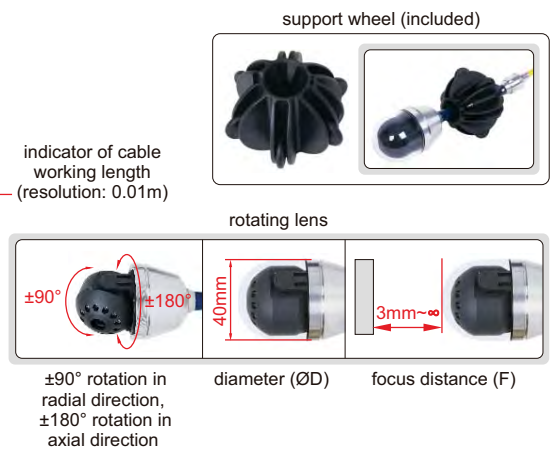

WIDE-ANGLE LENS CABLE

Code	VSP-201W	
Cable	length	30m
	type	high strength glass fibre
Lens	diameter (ØD)	24mm
	focus distance (F)	25mm~∞
	angle of view (θ)	100°
	illumination	12 pcs LED
	pixel	1M
	resolution	1280×720
dust/waterproof		IP67

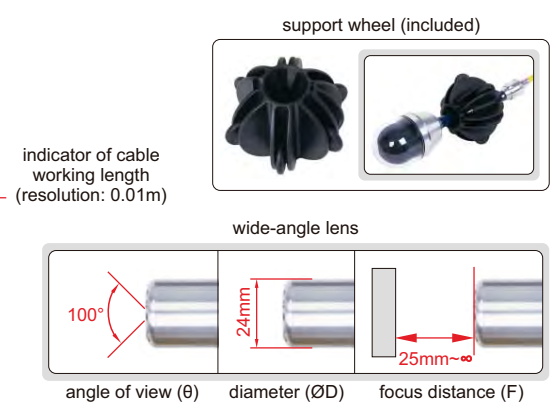

ADJUSTABLE SUPPORT

Code	Working diameter (ØD)	Remark
VSP-201-R200	60~200mm	for VSP-201R or VSP-201W

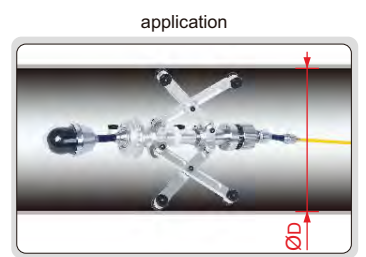

PIPE VIDEOSCOPE CODE ISV-VP280

IP68
WATERPROOF

**ATTENTION: RESISTANCE TO ACID AND
ALKALI LIQUID (CONSULT IS NEEDED)**

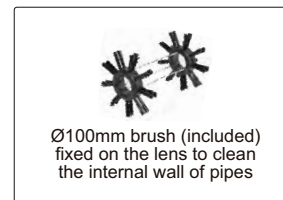
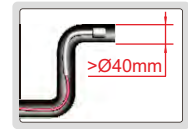
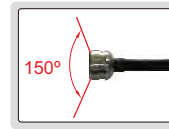
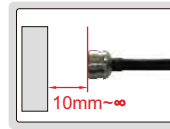
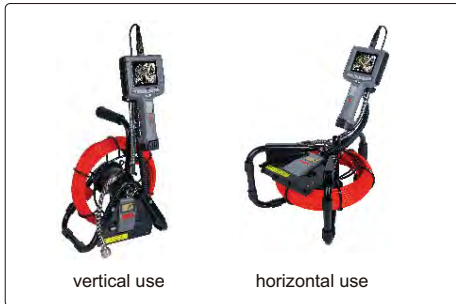

SPECIFICATION

Lens	diameter	28mm
	dust/waterproof	IP68
	pixel	0.3M
	resolution	640×480
	frame	30fps
Cable	length	30m
	dust/waterproof	IP68
	type	semi-rigid
Main unit	function	take picture and video
	file format	picture: JPG, video: ASF
	image process	mirror, rotate, zoom (1.5X, 2X)
	memory	4G SD card
	output	TV, USB
	power supply	4×AA batteries
Weight		5kg

STANDARD DELIVERY

Main unit	1 pc
Cable with lens	1 pc
Stand	1 pc
Indicator of cable working length	1 pc
4G SD card	1 pc
Ø100mm brush	1 pc
AA battery	4 pcs
AAA battery	2 pcs
Video output cable	1 pc
USB cable	1 pc

OPTIONAL ACCESSORY

Ø50mm centering ring	ISV-VP280-R50
Ø150mm brush	ISV-VP280-B150

IP67
WATERPROOF

RIGID BORESCOPIES

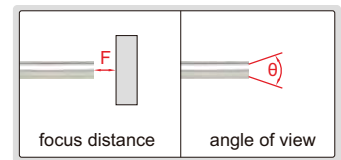
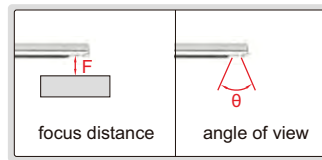
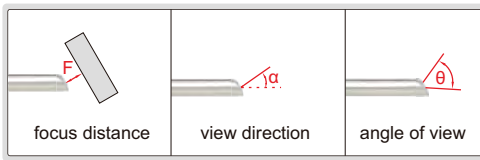

- Focus distance: 2mm, depth of view: 5~100mm
- Dust/waterproof level: IP67
- Can be used in liquid with temperature $-10^\circ\text{C}\sim 85^\circ\text{C}$



LED light handle (optional)



adjustable LED light source (optional)



camera and display (optional)

SPECIFICATION

Code	Length (L)	View direction (α)	Diameter (\varnothing D)	Angle of view (θ)
ISV-1H4170	174mm	0°	4mm	$\geq 60^\circ$
ISV-1H4173	174mm	30°		
ISV-1H4177	174mm	70°		
ISV-1H4179	166mm	90°		
ISV-1H4300	302mm	0°		
ISV-1H4303	302mm	30°		
ISV-1H4307	302mm	70°		

OPTIONAL ACCESSORY

LED light handle	ISV-1HLED
Adjustable LED light source	ISV-1LED1
Camera and display	ISV-2CAM

LED LIGHT HANDLE CODE ISV-1HLED

- For rigid borescopes



battery (included)



charger (included)

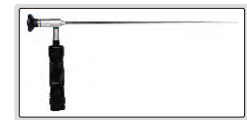

SPECIFICATION

Power	3W
Battery	3.7V rechargeable battery (for 2 hours working)
Dimension	120×27×27mm
Weight	300g

STANDARD DELIVERY

Main unit	1 pc
Battery	1 pc
Charger	1 pc

ADJUSTABLE LED LIGHT SOURCE CODE ISV-1LED1

- For rigid borescopes
- High LED illumination and brightness is adjustable
- For long time work with low noise



SPECIFICATION

Color temperature	5600K
Cooling	fan cooling
Power	AC110~220V, 50/60Hz
Dimension	400×300×112mm
Weight	7kg

STANDARD DELIVERY

Main unit	1 pc
1.8m optical fiber cable	1 pc

CAMERA (WITH DISPLAY) CODE ISV-2CAM



TAKE PICTURES
AND VIDEOS

AUTO FOCUS

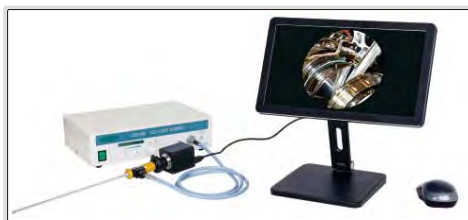

- For rigid borescopes
- 1080P high-definition image
- Auto-focus camera
- Take pictures and videos, saved to USB flash disk
- Automatic white balance and exposure
- Brightness, contrast ratio, gain are adjustable

SPECIFICATION

Sensor	1/2.8" CMOS
Pixel	2M
Resolution	1920×1080
Frame rate	60fps
Output	HDMI
Power supply	power adapter
Dimension (L×W×H)	350×100×430mm
Weight	2kg

STANDARD DELIVERY

Camera	1 pc
Connector	1 pc
13.3" LCD (with stand)	1 pc
16G USB flash disk	1 pc
Mouse	1 pc
HDMI cable	1 pc
Power adapter	2 pcs



16G USB flash disk (included)



Coating Thickness Gages
Page 614-617



Coating Thickness Gages
Page 618



Surface Profile Gages
Page 618-619



Wet Film Gages
Page 619



Gloss Meters
Page 620-621



Colorimeters
Page 622-624



Pencil Hardness Testers
Page 625



Cross Cut Adhesion Testers
Page 625



Digital Adhesion Testers
Page 626



Rotational Abrasion Testers
Page 627



Paint Film Flexibility Testers
Page 627



Impact Testers
Page 628

COATING THICKNESS GAGE (HIGH PRECISION) CODE ISO-8000FN

SUITABLE FOR THIN COATING
BELOW 10µm

FOR MAGNETIC AND
NON-MAGNETIC SUBSTRATES



calibration foils (included)



zero calibration plate
(included)



stand
(optional)



VIDEO



eddy current probe
(optional)



magnetic induction
probe
(included)

- Can measure thickness of thin coating below 10µm
- High repeatability
- Magnetic induction probe measures the thickness of non-magnetic coating and non-metallic coating on magnetic metal substrate
Substrate: iron, steel, magnetic stainless steel (not for non-magnetic stainless steel)
Coating: zinc, aluminum, copper, chrome, tin, plastic, powder, paint (not for nickel)
- Eddy current probe measures the thickness of non-conductive coating on non-magnetic metal substrate
Substrate: copper, aluminum, zinc, non-magnetic stainless steel
Coating: plastic, powder, paint, anodizing (not for chrome and zinc plating)
- Maximum, minimum, average and variance values can be calculated automatically

SPECIFICATION

Probe	Magnetic induction probe (included)	Eddy current probe (optional)*
Measuring range	0~500µm	0~1500µm
Resolution	0.1µm (range<100µm) 1µm (100µm≤range≤500µm)	0.1µm (range<100µm) 1µm (100µm≤range<1000µm) 0.01mm (1.00mm≤range≤1.50mm)
Accuracy	±(0.5+2%L)µm L is measuring thickness in µm	
Repeatability	≤(0.2+0.8%L)µm L is measuring thickness in µm	
Measuring mode	single and continuous	
Measuring interval	single mode	1.5s
	continuous mode	0.4s
Calibration mode	zero calibration and multi-points calibration (1~5 points)	
Minimum substrate thickness	0.1m	0.05mm
Minimum measuring area	Ø7mm	
Minimum radius of curvature workpieces	convex surface	1.5mm
	concave surface	10mm
Unit	µm/mil	
Power supply	4×1.5V AAA batteries	
Dimension	148×76×26mm	
Weight	148g	

STANDARD DELIVERY

Main unit	1 pc
Magnetic induction probe	1 pc
Zero calibration plate	1 pc
Calibration foils (5.6µm, 11.6µm, 24.6µm, 50.0µm, 100µm, 252µm, 390µm)	1 set
1.5V AAA battery	4 pcs

OPTIONAL ACCESSORY

Eddy current probe (with zero calibration plate)	ISO-8000FN-N1500*
Stand	ISO-8000FN-STAND

*For precision measurement of thin coating below 10µm, please use the stand for eddy current probe



BLUETOOTH

FOR MAGNETIC AND
NON-MAGNETIC SUBSTRATES

DATA
OUTPUT

COATING THICKNESS GAGE CODE 9501-1200

POPULAR
MODEL



eddy current probe
NFE (optional) with
zero calibration block



magnetic induction
probe FE90 for bores
and grooves (optional)



calibration foils
(included)



magnetic induction
probe FE10 for large
range (optional)



zero calibration block
for FE (included)



receiver (optional)



button for data
transmission

magnetic induction
probe FE (included)

- Magnetic induction probe (FE) measures the thickness of non-magnetic coating and non-metallic coating on magnetic metal substrate.
Substrate: iron, steel, magnetic stainless steel (not for non-magnetic stainless steel)
Coating: zinc, copper, chrome, tin, plastic, powder, paint (not for nickel)
- Eddy current probe (NFE) measures the thickness of non-conductive coating on non-magnetic metal substrate.
Substrate: copper, aluminum, zinc, non-magnetic stainless steel
Coating: plastic, powder, paint, anodizing (not for chrome and zinc plating)
- Tolerance measurement
- Data statistic, including average, variance, maximum and minimum values
- Data can be sent to Excel by connecting to computers via bluetooth or cable of receiver
- Support bluetooth printer
- Automatic power off

SPECIFICATION

Probe type	FE (included) magnetic induction probe	NFE (optional) eddy current probe	FE90 (optional) magnetic induction probe for bores and grooves	FE10 (optional) magnetic induction probe for large range
Measuring range	0~1250µm	0~1250µm	0~1250µm	500~10000µm
Accuracy	±(3%L+1)µm (range≤1250µm) ±(3%L+10)µm (range>1250µm)		L is measuring thickness in µm	
Resolution	0.1µm (range<100µm) 1µm (range≥100µm)			
Measuring mode	continuous and single			
Minimum substrate thickness	0.5mm	0.3mm	0.5mm	2mm
Minimum measuring area	Ø7mm	Ø5mm	Ø7mm	Ø40mm
Minimum curvature radius of convex workpiece	1.5mm	3mm	—	10mm
Memory	600			
Output	USB			
Power supply	2×1.5V AA batteries			
Dimension	135×77×32mm			
Weight	172g			

STANDARD DELIVERY

Main unit	1 pc
Magnetic induction probe (FE)	1 pc
Zero calibration block for FE probe	1 pc
Calibration foils (50/100/250/500/1000µm)	1 set
1.5V AA battery	2 pcs
Software and USB cable	1 pc

OPTIONAL ACCESSORY

Receiver	ISR-C300-RECEIVER
Cable of receiver	9501-1200-CABLE
Bluetooth printer	ISR-C002-PRINTER
Eddy current probe (NFE) with zero calibration block	9501-1200-NFE
Magnetic induction probe (FE90) for bores and grooves	9501-1200-FE90
Magnetic induction probe (FE10) for large range	9501-1200-FE10

COATING THICKNESS GAGE (BASIC TYPE) CODE ISO-1200FN

FOR MAGNETIC AND
NON-MAGNETIC SUBSTRATES

- Probe is suitable for both magnetic and non-magnetic metal substrates
- Can measure the thickness of non-magnetic coating and non-metallic coating on magnetic metal substrate
Substrate: iron, steel, magnetic stainless steel (not for non-magnetic stainless steel)
Coating: zinc, aluminum, copper, chrome, tin, plastic, powder, paint (not for nickel)
- Can measure the thickness of non-conductive coating on non-magnetic metal substrate
Substrate: copper, aluminum, zinc, non-magnetic stainless steel
Coating: plastic, powder, paint, anodizing (not for chrome and zinc plating)
- 3 measuring modes: Fe, NFe, Fe/NFe
- Store 9 measuring records
- Small and portable, easy for operation



ruby contact point

SPECIFICATION

Measuring range	0~2000μm	
Resolution	0.1μm (range<100μm) 1μm (100μm≤range<1000μm) 0.01mm (1mm≤range≤2mm)	
Accuracy	±(2μm+3%L) L is measuring thickness in μm	
Measure interval	0.5s	
Calibration mode	zero calibration	
Measuring mode	Fe, NFe, Fe/NFe	
Minimum substrate thickness	Fe	0.2mm
	NFe	0.05mm
Minimum measuring area	Ø25mm	
Minimum radius of curvature workpieces	convex surface	5mm
	concave surface	25mm
Unit	μm/mil	
Power supply	2×1.5V AAA batteries	
Main unit dimension	101×62×28mm	
Probe dimension	71×26×22mm	
Weight	114g	



Fe zero calibration plate
(included)



NFe zero calibration plate
(included)

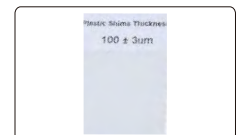

standard foil (included)

STANDARD DELIVERY

Main unit	1 pc
Fe zero calibration plate	1 pc
NFe zero calibration plate	1 pc
Standard foil (100μm)	1 pc
1.5V AAA battery	2 pcs



FOR MAGNETIC AND
NON-MAGNETIC SUBSTRATES

COATING THICKNESS GAGE (BASIC TYPE) CODE ISO-1000FN

- Probe is suitable for both magnetic and non-magnetic metal substrates
- Can measure the thickness of non-magnetic coating and non-metallic coating on magnetic metal substrate
Substrate: iron, steel, magnetic stainless steel (not for non-magnetic stainless steel)
Coating: zinc, aluminum, copper, chrome, tin, plastic, powder, paint (not for nickel)
- Can measure the thickness of non-conductive coating on non-magnetic metal substrate
Substrate: copper, aluminum, zinc, non-magnetic stainless steel
Coating: plastic, powder, paint, anodizing (not for chrome and zinc plating)
- 3 measuring modes: Fe, NFe, Fe/NFe
- Store 9 measuring records
- Small and portable, easy for operation



ruby contact point

SPECIFICATION

Measuring range	0~2000µm	
Resolution	0.1µm (range<100µm)	
	1µm (100µm≤range<1000µm)	
	0.01mm (1mm≤range≤2mm)	
Accuracy	±(2µm+3%L) L is measuring thickness in µm	
Measure interval	0.5s	
Calibration mode	zero calibration	
Measuring mode	Fe, NFe, Fe/NFe	
Minimum substrate thickness	Fe	0.2mm
	NFe	0.05mm
Minimum measuring area	Ø25mm	
Minimum radius of curvature workpieces	convex surface	5mm
	concave surface	25mm
Unit	µm/mil	
Power supply	2×1.5V AAA batteries	
Dimension	101×62×28mm	
Weight	79g	

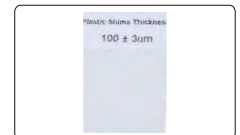

standard foil (included)



Fe zero calibration plate (included)



NFe zero calibration plate (included)

STANDARD DELIVERY

Main unit	1 pc
Fe zero calibration plate	1 pc
NFe zero calibration plate	1 pc
Standard foil (100µm)	1 pc
1.5V AAA battery	2 pcs

CALIBRATION FOILS FOR COATING THICKNESS GAGE

- To calibrate or check the accuracy of coating thickness gages
- Increase the measurement accuracy after foil calibration
- Uniformity: ±0.3µm (≤50µm), ±0.6% (>50µm)
- Dimension: 45×30mm (thickness≤2000µm), 50×30mm (thickness>2000µm)
- Supplied with manufacturer inspection certificate



26

Code	Thickness	Deviation*	Uniformity
9503-FL1	11.5µm	±5%	±0.3µm
9503-FL2	23µm	±5%	±0.3µm
9503-FL3	50.5µm	±5%	±0.6%
9503-FL4	102µm	±5%	±0.6%
9503-FL5	250µm	±5%	±0.6%
9503-FL6	495µm	±3%	±0.6%
9503-FL7	995µm	±2%	±0.6%
9503-FL8	1780µm	±5%	±0.6%
9503-FL9	3725µm	±4%	±0.6%
9503-FL10	7650µm	±2%	±0.6%

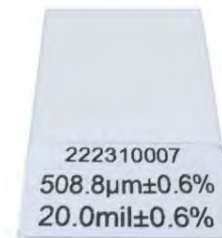

9503-FL6

* Deviation between the ordered thickness and the thickness marked on the calibration foils when supplied

X RAY FLUORESCENCE SPECTROMETER (RoHS DETECTOR/ALLOY COMPOSITION ANALYZER/COATING THICKNESS GAGE) CODE XRF-B210

REFER TO PAGE
466-467 FOR DETAILS

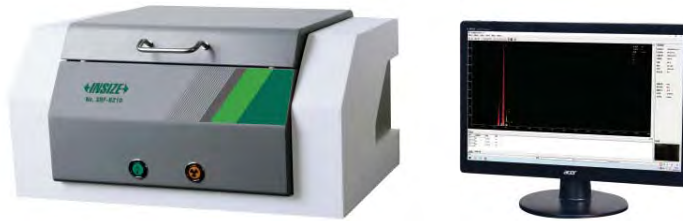

SURFACE PROFILE GAGE

measure peak-to-valley height
of blast cleaned surfaces

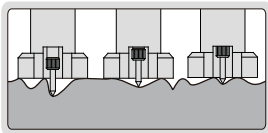

- Measure peak-to-valley height of blast cleaned surface.
If the profile is too low, the adhesion of the coating to the surface will be reduced.
If the profile is too high, there is the danger that the profile peaks will remain uncoated, allowing rust spots to occur.
- Meet ASTM D 4417-B
- Zero set block is included, set zero before measurement
- Stainless steel base



2344-1

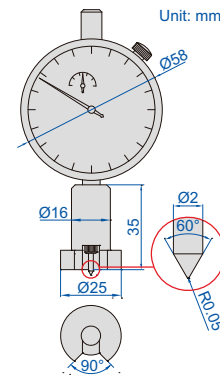

VIDEO

set zero



zero set block
(included)

Code	Range	Dial indicator stroke	Dial indicator graduation	Accuracy
2344-1	0-1mm	1mm	0.001mm	±0.005mm

DIGITAL SURFACE PROFILE GAGE

measure peak-to-valley height
of blast cleaned surfaces

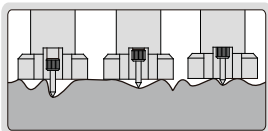

- Measure peak-to-valley height of blast cleaned surface.
If the profile is too low, the adhesion of the coating to the surface will be reduced.
If the profile is too high, there is the danger that the profile peaks will remain uncoated, allowing rust spots to occur.
- Meet ASTM D 4417-B
- Zero set block is included, set zero before measurement
- Button function: on/off, zero, mm/inch, absolute/incremental measurement
- CR2032 battery, automatic power off (time is adjustable)
- Data output
- Stainless steel base
- Optional accessory: data output cable (code 7315-50M page 5, 7302-40M page 13)



2843-10

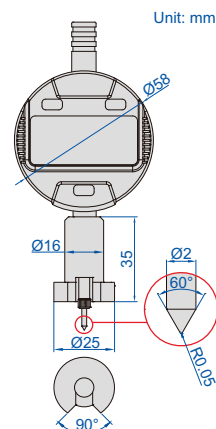

DATA
OUTPUT



VIDEO

set zero



zero set block
(included)

Code	Range	Digital indicator stroke	Digital indicator resolution	Accuracy
2843-10	0-12.7mm/0-0.5"	12.7mm/0.5"	0.001mm/0.00005"	±0.005mm

DATA
OUTPUT

DISPLAY MAXIMUM, MINIMUM, DIFFERENCE
VALUE BETWEEN MAXIMUM AND MINIMUM

DIGITAL SURFACE PROFILE GAGE



measure peak-to-valley height
of blast cleaned surfaces

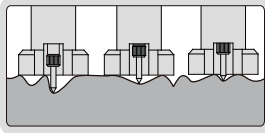

2844-10

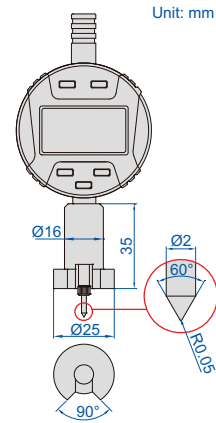

- Measure peak-to-valley height of blast cleaned surface. If the profile is too low, the adhesion of the coating to the surface will be reduced. If the profile is too high, there is the danger that the profile peaks will remain uncoated, allowing rust spots to occur.
- Meet ASTM D 4417-B
- Zero set block is included, set zero before measurement
- Button function: tolerance Go and No-Go display, data preset, measuring direction change, max./min./TIR measurement, inch/metric conversion, absolute/incremental measurement
- CR2032 battery, automatic power off (time is adjustable)
- Data output
- Stainless steel base
- Optional accessory: data output cable (code **7315-50M** page 5, **7302-40M** page 13)



Code	Range	Digital indicator stroke	Digital indicator resolution	Accuracy
2844-10	0-12.7mm/0-0.5"	12.7mm/0.5"	0.001mm/0.00005"	±0.005mm

WET FILM GAGES



4845-1

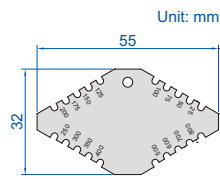

4845-1



4845-2

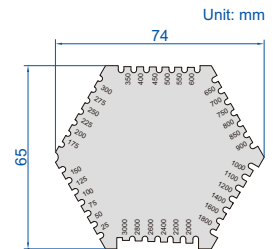

4845-2

- Made of stainless steel

Code	Range	Accuracy	Thickness
4845-1	25-800µm	±5µm	1.8mm
4845-2	25-3000µm	25-100µm: ±5µm 100µm-3000µm: ±5%	1mm

60° GLOSS METER (BASIC TYPE) CODE 5702-DG6

- To test the gloss of coating, such as painting, varnish, printing ink, etc.
- To test the material surfaces, such as metal, granite, ceramic, plastic, paper, etc.
- According to ISO 2813, ISO 7668, ASTM D523, ASTM D2457, DIN 67530
- Automatic judgement after setting high and low limits
- Automatic power off

SPECIFICATION

Incidence angle	60°
Measuring range	0~200GU
Resolution	0.1GU
Accuracy	±1.5GU (range<120GU) ±1.5% (range≥120GU)
Repeatability	0.2GU (range<120GU) 0.2% (range≥120GU)
Zero error	0.1GU
Measuring area	20×10mm
Power supply	rechargeable battery
Data port	USB
Dimension	135×45×75mm
Weight	237g

STANDARD DELIVERY

Main unit	1 pc
Base with calibration block	1 pc
U disk	1 pc
AC/DC adapter	1 pc
USB data cable	1 pc
Cleaning cloth	1 pc



VIDEO



base with calibration block
(included)



software (included), test can be controlled from the software,
display test data and report



report

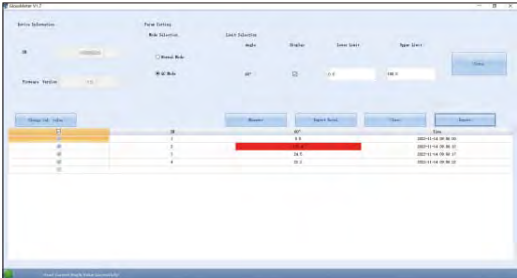

software

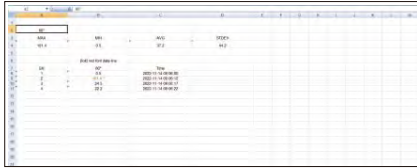

measurement data is sent to Excel

60° GLOSS METER CODE ISQ-DG6

- To test the gloss of coating, such as painting, varnish, printing ink, etc.
- To test the material surfaces, such as metal, granite, ceramic, plastic, paper, etc.
- According to ISO 2813, ASTM D2457, ASTM D523
- Automatic power off

SPECIFICATION

Incidence angle	60°
Measuring range	0~150GU
Resolution	0.1GU
Accuracy	±1.2GU
Repeatability	0.4GU
Zero set error	0.2GU
Measuring area	20×10mm
Output	bluetooth
Power supply	1×1.5V AA battery
Dimension	123×38×65mm
Weight	300g

STANDARD DELIVERY

Main unit	1 pc
Base with calibration block	1 pc
Spare calibration block	1 pc



base with calibration block
(included)



connect mobile phone via bluetooth
(only Android system)



operate and output data by mobile phone



VIDEO



DATA
OUTPUT

BLUETOOTH

CAN BE OPERATED BY
COMPUTERS OR MOBILE PHONES

20°/60°/85° GLOSS METER CODE ISQ-DG8



base with calibration block
(included)



software flash disk
(included)

- To test the gloss of coating, such as painting, varnish, printing ink, etc.
- To test the material surfaces, such as metal, granite, ceramic, plastic, paper, etc.
- According to ISO 2813, ASTM D2457, ASTM D523
- Memory of 10000 measurement results for browsing and output
- Automatic power off

connect to mobile phone via bluetooth
(only Android system)



operate and output data by mobile phone

connect to computer via bluetooth or USB cable



bluetooth receiver
(included)

SPECIFICATION

Incidence angle	20°	60°	85°
Measuring range	0~2000GU	0~1000GU	0~160GU
Resolution	0.1GU (range≤119.9GU) 1GU (range>119.9GU)		
Accuracy	±1.5GU (range≤119.9GU) ±1.5% (range>119.9GU)		
Repeatability	0.2GU (range≤119.9GU) 0.2% (range>119.9GU)		
Zero set error	0.2GU		
Measuring area	10×9mm	16×9mm	39×5mm
Output	USB and bluetooth		
Power supply	1×1.5V AA battery		
Dimension	155×48×75mm		
Weight	400g		

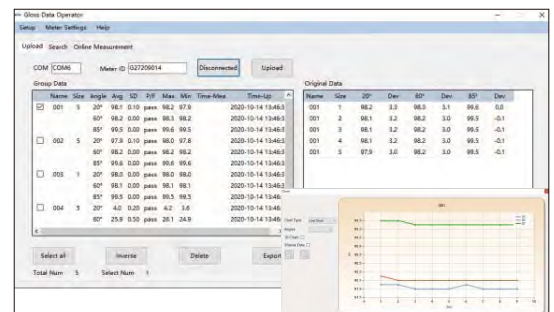

software (included), test can be controlled from the software,
display test data, output to Excel

STANDARD DELIVERY

Main unit	1 pc
Base with calibration block	1 pc
Software and USB cable	1 pc
Bluetooth receiver	1 pc

SPECTROPHOTOMETER CODE 9710-30

DATA
OUTPUT

CONCAVE GRATING
SPECTROPHOTOMETRIC

Ø8/4mm DUAL APERTURE

BLUETOOTH

- Concave grating spectrophotometric
- 3.5 inch TFT color LCD, capacitive touch screen, 256 image element double arrays CMOS image sensor
- D/8 geometrical optics, conforms with CIE No.15, ISO7724/1, ASTM E1164, DIN5033 Teil 7
- Use long life and low power consumption combined LED light source
- Camera locating function, switchable 8mm/4mm aperture, support both SCI and SCE at the same time
- Large capacity storage space, over 20,000 measurement data
- USB port and Bluetooth 4.0
- Two standard observer angles, a variety of illuminant, a variety of color indexes, conforms with a variety of standard colorimetric data
- Measure sample spectra, accurate Lab data, can be used in color matching and accurate color transmission



SPECIFICATION

Optical geometry	reflect: di: 8°, de: 8° (diffused illumination, 8-degree viewing angle)	
Integrating sphere size	Ø48mm	
Light source	combined LED light, UV light	
Spectrophotometric mode	concave grating	
Sensor	256 image element double array CMOS image sensor	
Wavelength range	400~700nm	
Wavelength interval	10nm	
Semiband width	10nm	
Measured reflectance range	0~200%	
Measuring aperture	dual aperture: MAV: Ø8mm; SAV: Ø4mm	
Specular component	SCI&SCE	
Color space	CIE LAB, XYZ, Yxy, LCh, CIE LUV, hunter LAB	
Color difference formula	ΔE^*ab , ΔE^*uv , ΔE^*94 , ΔE^*cmc (2:1), ΔE^*cmc (1:1), ΔE^*00v , ΔE (Hunter)	
Other colorimetric index	WI (ASTM E313, CIE/ISO, AATCC, hunter), YI (ASTM D1925, ASTM 313), metamerism index MI, staining fastness, color fastness, color strength, opacity	
Observer angle	2°/10°	
Illuminant	A, C, D50, D55, D65, D75, F1, F2, F3, F4, F5, F6, F7, F8, F9, F10, F11, F12, CWF, U30, T183, T184, U35	
Displayed data	spectrogram/values, samples chromaticity values, color difference values/graph, PASS/FAIL result, color offset	
Measuring time	2.6s	
Repeatability	spectral reflectance	MAV/SCI, within 0.08% of standard deviation (400~700nm: 0.18%)
	colorimetric values	MAV/SCI: $\Delta E^* \leq 0.03$
Inter-instrument error	MAV/SCI: $\Delta E^* \leq 0.15$	
Measurement mode	single measurement, average measurement	
Data port	USB, bluetooth 4.0	
Data storage	standard 1000 pcs, sample 28000 pcs	
Illuminant life span	5 years, more than 3 million times measurements	
Battery	Li-ion battery, 5000 measurements within 8 hours	
Dimension	184×77×105mm	
Weight	600g	



software flash disk (included)



white and black calibration cavity (included)



printer (optional)



measurement



reflectivity

software

measurement data is sent to Excel

report

software (included), test can be controlled from the software, display test data, report

STANDARD DELIVERY

Main unit	1 pc
White and black calibration cavity	1 pc
Software and USB cable	1 pc
AC/DC adapter	1 pc

OPTIONAL ACCESSORY

Printer	9710-PRINTER
Powder test box	9710-POWDERBOX
Universal test kit	9710-TESTKIT



- Conforms with CIE No.15, ISO7724-1, ASTM E1164 and DIN5033 Teil7 standards
- Grating spectrophotometric, 3.5" IPS full color screen, dual optical path high precise CMOS array sensor
- Use long life and low power consumption combined LED light source, include UV and exclude UV measurement
- Camera locating function, switchable 11mm/6mm/1×3mm aperture
- Large capacity storage space, over 20000 measurement data
- Two standard observer angles, a variety of illuminant, a variety of color indexes, conforms with a variety of standard colorimetric data
- Measure sample spectra, accurate Lab data, can be used in color matching and accurate color transmission

SPECTROPHOTOMETER CODE 5701-D40

FOUR KINDS OF APERTURE

GRATING
SPECTROPHOTOMETRIC

DATA
OUTPUT

MATCHING COLOR
CARD QUICKLY



SPECIFICATION

Optical geometry	D/8 (diffused illumination/8° direction reception), SCI+SCE (specular component included+specular component excluded)	
Integrating sphere size	Ø40mm	
Light source	LED (full band balanced LED)+UV	
Spectrophotometric mode	grating	
Sensor	dual optical path high precise CMOS array sensor	
Wavelength range	400~700nm	
Wavelength interval	10nm	
Reflectance measurement range	0~200%	
Reflectance resolution	0.01%	
Display resolution	0.01	
Illumination area/aperture	MAV: Ø11mm; SAV: Ø6mm, Ø3mm; MINI: 1×3mm	
Color space	CIE-Lab, CIE-LCh, HunterLab, CIE Luv, XYZ, Yxy, RGB	
Color difference formula	ΔE^*ab , ΔE^*cmc , ΔE^*94 , ΔE^*00	
Other colorimetric index	whiteness (ASTM E313-00, ASTM E313-73, CIE/ISO, AATCC, hunter, taube berger stensby), yellowness (ASTM D1925, ASTM 313-00, ASTM E313-73), blackness (My, dM), color fastness, tint (ASTM E313-73) color density CMYK (A, T, E, M), milm, munsell, opacity, color strength	
Observer angle	2°/10°	
Illuminant	A, B, C, D50, D55, D65, D75, F1, F2, F3, F4, F5, F6, F7, F8, F9, F10, F11, F12, CWF, U30, U35, DLF, NBF, T183, T184, Id50, Id65, LED-B1, LED-B2, LED-B3, LED-B4, LED-B5, LED-BH1, LED-RGB1, LED-V1, LED-V2	
Measuring time	about 1.5s	
Repeatability	spectral reflectance	within 0.08% of standard deviation
	colorimetric values	$\Delta E^*ab \leq 0.025$ (after whiteboard correction, measuring the whiteboard 30 times at 5s interval)
Inter-instrument error	$\Delta E^*ab \leq 0.25$ (BCRA series II, average value of 12 color plates)	
Data port	USB, bluetooth	
Light source lifetime	10 years, more than 1 million times measurements	
Battery	3.7V/3000mAh, rechargeable 8000 times continuous tests	
Dimension	95×129×231mm	
Weight	750g	



software (included), test can be controlled from the software, display test data, report

software

pure data report

graphic report



To be continued

Continued from previous page

STANDARD DELIVERY

Main unit	1 pc
White calibration cavity	1 pc
Measuring aperture	3 pcs
USB cable	1 pc
USB disk	1 pc
AC/DC adapter	1 pc



white calibration cavity (included)

connect to computer

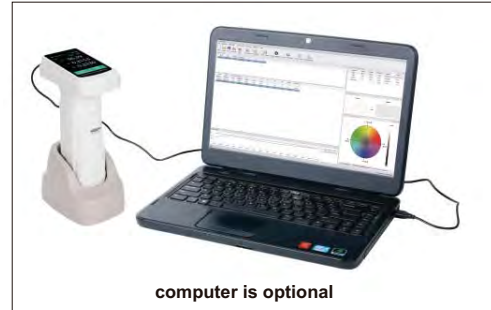

computer is optional

**COLORIMETER (BASIC TYPE)
CODE 5700-LS35**

- Conforms with CIE 15, CIE S 005, ISO 7724-1 and ISO 13655 standards
- 3.5-inch IPS display and capacity touch panel
- Contains multiple color cards and can match the closest color code quickly
- QC testing function, can set color difference threshold
- Able to store 1000 colors and 1000 color comparison
- 3.7V/4000mAh battery, 10000 continuous measurements



white calibration cavity (included)



SPECIFICATION

Illumination geometry	D/8, specular component include (SCI)
Illumination light source	full spectrum LED light source
Measurement conditions	light source D65, field of view 10°
Measuring time	about 1s
Color space	CIE Lab, Luv, LCh, Yxy, CMYK, RGB, Hex
Color difference formula	ΔE^*ab , ΔE^*uv , ΔE^*94 , $\Delta E^*cmc(2:1)$, $\Delta E^*cmc(1:1)$, ΔE^*00
Repeatability	standard deviation ΔE^*ab is within 0.03 (measurement condition: the average value of 30 measurements on the whiteboard at an interval of 3s after calibration)
Charging interface	USB (Type-C)
Dimension	86×63×158mm
Weight	245g

STANDARD DELIVERY

Main unit	1 pc
White calibration cavity	1 pc
USB cable	1 pc
AC/DC adapter	1 pc
Cleaning cloth	1 pc
Locating plate	1 pc

**STANDARD COLOR PLATES
CODE 5704-CP01**

- To calibrate color measuring instruments
- Made of ceramic
- Wear resistance, corrosion resistance, high optical stability
- Supplied with ISO17025 calibration certificate from National Institute of Metrology, China

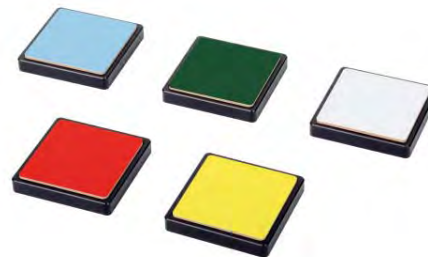

SPECIFICATION

Spectral reflectance factor	spectral reflectance factor in the wavelength range of 380nm to 780nm
Standard illuminant	A, D65, etc
Viewing angle	2°, 10°
Color space	CIE-Lab, XYZ, etc
Annual variation	$\Delta x, \Delta y \leq 0.005$
Dimension	50×50mm

STANDARD DELIVERY

Protective gloves	1 pair
Calibration certificate	1 pc

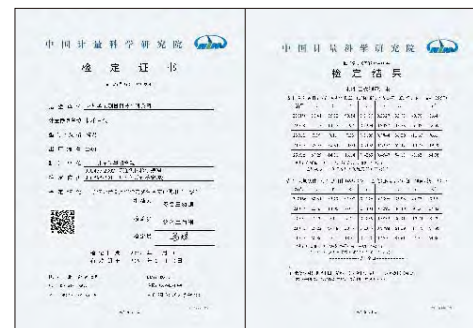

calibration certificate (included)



- For flat coating surfaces
- Conform to ASTM D3363, ISO 15184, BS3900-E19 and ECCA-T4/1



PENCIL HARDNESS TESTER CODE PHT-C751

SPECIFICATION

Pressure of pencil on coating	500g, 750g, 1000g (main unit is 500g, one weight is 750g, two weights are 1000g)
Angle between pencil and measured surface	45°
Dimension (L×W×H)	95×80×110mm
Weight	2kg



STANDARD DELIVERY

Main unit	1 pc
Weights	2 pcs
Leveling rod	1 pc
Level	1 pc
Pencil	12 pcs (4B, 3B, 2B, B, HB, F, H, 2H, 3H, 4H, 5H, 6H)
Pencil sharpener	1 pc



level (included)



pencils (included)



leveling rod (included)

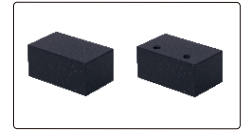

weights (included)

OPTIONAL DELIVERY

Pencil (17 pcs: 6B-9H)	PHT-C751-P
400 grade abrasive paper	PHT-C751-S



- To test the adhesion of paint coating on metal, wood, plastic, etc.
- According to ISO 2409, ASTM D3359, DIN53151



CROSS CUT ADHESION TESTER CODE ISQ-PK100

SPECIFICATION

Blade		1mm pitch	2mm pitch	3mm pitch
Applied paint thickness	on hard substrate (like metal)	0~60µm	61~120µm	121~250µm
	on soft substrate (like wood, plaster)	—	0~120µm	121~250µm
Minimum substrate thickness	hard substrate (like metal)	0.25mm	0.25mm	0.25mm
	soft substrate (like wood, plaster)	—	10mm	10mm
Minimum size of test sample		150×100mm	150×100mm	150×100mm
Dimension		170×28×40mm		
Weight		430g		



3mm pitch blade (included)



2X magnifier (included)



2mm pitch blade (included)



1mm pitch blade (included)



brush (included)



test tape (included)
ISQ-PK100-1

STANDARD DELIVERY

Handle	1 pc
1mm pitch blade	1 pc
2mm pitch blade	1 pc
3mm pitch blade	1 pc
Test tape (ISQ-PK100-1)	1 pc
2X magnifier	1 pc
Brush	1 pc



step 1: make grid cutting on surface



step 2: paste and remove the tape

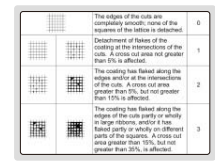

step 3: according to the shedding status, judge the adhesion grade

DIGITAL ADHESION TESTER

CODE SPT-AD21



Ø20mm dolly (included)



glue gun and glue (included)



cutting tool (included)
for Ø10mm, Ø14mm, Ø20mm dolly

- Pull-off test
- Built-in rechargeable lithium battery, no need external power source
- Portable design, can be used anywhere
- Standard USB interface, can directly transmit the stored data to computer, no need to install software
- Conforms to GB/T 5210, ASTM D4541/D7234, ISO 4624/16276-1
- Store all test results, includes maximum pull-off force, pull-off rate, dolly size and time
- Built in real-time clock, all saved data have corresponding date and time
- Selectable four different sizes dolly for different resolution and testing range
- No need conversion, the instrument can calculate pull-off force according to the dolly size
- Get the testing results from LCD directly
- Two units MPa and psi for selection and can be converted automatically

SPECIFICATION

Range	0~20MPa
Dolly diameter	Ø20mm
Resolution	0.01MPa (1psi)
Accuracy	±1% full scale
Pull-off Force	0.7~20MPa
Power	built-in rechargeable lithium battery
Dimension (LxWxH)	360x75x115mm
Weight	3kg

STANDARD DELIVERY

Main unit	1 pc
Ø20mm dolly	20 pcs
Cutting tool for Ø20mm dolly	1 pc
Charger	1 pc
USB cable	1 pc
Glue gun	1 pc
3M glue	1 pc

OPTIONAL ACCESSORY

Ø10mm dolly	SPT-AD21-10	10 pcs/package pull-off force: 2.8~80MPa
Ø14mm dolly	SPT-AD21-14	10 pcs/package pull-off force: 1.4~40MPa
Ø20mm dolly	SPT-AD21-20	10 pcs/package pull-off force: 0.7~20MPa
Ø50mm dolly	SPT-AD21-50 *	10 pcs/package pull-off force: 0.4~3.5MPa
Cutting tool	SPT-AD21-CUTTER1	for Ø10mm, Ø14mm, Ø20mm dolly
Cutting tool	SPT-AD21-CUTTER2 *	for Ø50mm dolly
Sleeve	SPT-AD21-SLEEVE *	for Ø50mm dolly
Glue	SPT-AD21-GLUE	3M DP420 epoxy glue/50ml

* Ø50mm dolly requires corresponding cutter and sleeve



ROTATIONAL ABRASION TESTER CODE QMY-AP32

- To test flat paint film
- Comply with ISO 7784-2, ISO 9352, GB/T1768, ASTM D3884, ASTM D1175 standards

SPECIFICATION

Platform rotary speed	60±2 r/min, 72±2 r/min (selectable)
Load weight	500g, 750g, 1000g
Sample size	Ø100mm
Grinding wheel	external diameter (51.6±0.1)mm, thickness (12.7±0.1)mm
Counting range of platform rotation	0~9999 times
Motor power	25W
Power supply	220V, 50Hz
Dimension	260×410×280mm
Weight	14kg



STANDARD DELIVERY

Main unit	1 pc
Vacuum cleaner	1 pc
1000g weight	2 pcs
750g weight	2 pcs
500g weight	2 pcs
TABER CS-10 grinding wheel	1 pair
Sandpaper	10 pcs
Glass plate	5 pcs

OPTIONAL ACCESSORY

TABER CS17 grinding wheel (1 pair)	QMY-AP32-CS17
Glass plate (Ø100mm with a 9mm center hole, 100 pcs/box)	QMY-AP32-GP
Aluminum plate (Ø100mm with a 9mm center hole, 100 pcs/box)	QMY-AP32-AP
180# emery cloth strip (100 pcs/box)	QMY-AP32-EC

PAINT FILM FLEXIBILITY TESTER CODE PPF-BF62

- To test the flexibility of paint and varnish
- Bend the coated test plates on the shaft rods with different diameter, the minimum shaft rod diameter that does not cause damage to the film is the film flexibility



SPECIFICATION

Shaft rod length	35mm
Shaft rod 1	Ø15mm
Shaft rod 2	Ø10mm
Shaft rod 3	Ø5mm
Shaft rod 4	Ø4mm
Shaft rod 5	cross section 3×10mm, radius of curved surface 1.5mm
Shaft rod 6	cross section 2×10mm, radius of curved surface 1.0mm
Shaft rod 7	cross section 1×10mm, radius of curved surface 0.5mm
Dimension	450×75×100mm
Weight	3.1kg

STANDARD DELIVERY

Main unit	1 pc
Test plate	1 box (500 pcs)
4X magnifier	1 pc

OPTIONAL ACCESSORY

Test plate (dimension: 120×25×0.28mm, 500 pcs/box)	PPF-BF62-TP
--	-------------



IMPACT TESTER CODE THD-PF34



300g main weight
(included)



1000g main weight
(included)



2lb main weight
(included)



2lb additional
weight (included)



1000g additional
weight (included)



Ø16.3mm die base
(included)



Ø12.7mm indenter
(included)



Ø15.9mm indenter
(included)



- For paint and varnish dry coating. To test the ability to resist cracking or peeling from the substrate when deformation is caused by weights impact under standard conditions
- Indenter, base and weight can be replaced quickly
- Conform to ISO 6272-2:2002, ASTM D 2794

SPCIFICATION

Impact height range	0-100cm (0-40inch)
Graduation	1cm
Impact depth	2.5cm
Weight	1000g (2 pcs), 300g (1 pc), 2lb (2 pcs)
Indenter diameter	Ø12.7mm (1/2 inch DIA), Ø15.9mm (5/8 inch DIA)
Die base diameter	Ø16.3mm

OPTIONAL ACCESSORY

Base plate (120×70×0.5mm, 180 pcs/box) *	THD-PF34-T
--	------------

*Can be customized according to the needs of different thickness, size and processing

STANDARD DELIVERY

Main unit	1 pc
1000g main weight	1 pc
300g main weight	1 pc
2lb main weight	1 pc
1000g additional weight	1 pc
2lb additional weight	1 pc
Ø12.7mm indenter	1 pc
Ø15.9mm indenter	1 pc
Ø16.3mm die base	1 pc



Ultrasonic Thickness Gages
Page 631-638



Tachometers
Page 638-639



Stroboscopes
Page 640



Vibration Pens
Page 640-641



Digital Multimeters
Page 641-644



Digital AC/DC Clamp Meters
Page 645



Voltage Testers
Page 646



Laser Distance Meters
Page 647



Portable Conductivity/TDS Meters
Page 647



Portable pH Meters
Page 648



Refractometers
Page 648-650



Digital Stopwatches
Page 650



Stroke Counters
Page 650



Digital Moisture Meters
Page 651



Differential Pressure Manometers
Page 652



Anemometers
Page 653



Bourdon Tube Pressure Gages
Page 653



Digital Sound Level Meters
Page 654-655



Light Meters
Page 655-657



Gas Detectors
Page 657-658



Teslameters
Page 659



Laser Belt Tension Meters
Page 659

PENETRATE COATING AND MEASURE THE THICKNESS OF SUBSTRATE

BLUETOOTH

REAL-TIME TEMPERATURE COMPENSATION

DATA OUTPUT

ULTRASONIC THICKNESS GAGE (ADVANCED TYPE) CODE ISU-800D

- Real-time temperature compensation eliminates the error caused by temperature variation
- Support both single element transducers and dual element transducers
- Measure the thickness of substrate through coating
- Measuring mode: standard mode (dual element transducer: P-E mode, single element transducer: I-E mode), penetrate coating mode (dual element transducer: I-E mode, single element transducer: E-E mode or auto mode)
- Measure method: single point, scanning, deviation
- Set upper and lower limits for alarm when out-of-tolerance
- Single point and 2 points calibration
- Keyboard lock function avoids parameter setting change caused by unintended press during measurement
- Memory 1000 measurement values
- Data can be transferred to PC by Bluetooth connection or Mini-USB cable



transducer
ISU-S15-P06
(included)

transducer
ISU-S15-P06
(included)



transducer
ISU-S2M-P14
(optional)



transducer
ISU-G5M-P10
(optional)



transducer
ISU-G5M-P08
(optional)



transducer
ISU-G7M-P06
(optional)



transducer
ISU-G2M-P12
(optional)



transducer
ISU-H3M-P12
(optional)



delay block
ISU-S15-P06-CB
(optional)



delay block
ISU-S15-P06-CB1
(optional)



SPECIFICATION

Measuring range	refer to the specification of transducers
Resolution	0.01mm/0.001mm
Accuracy	refer to the specification of transducers
Data output	bluetooth and USB
Velocity	1~19999m/s
Power supply	3.7V rechargeable lithium battery
Dimension	157×78×37mm
Weight	260g

STANDARD DELIVERY

Main unit	1 pc
Transducer ISU-S15-P06	1 pc
Power adaptor	1 pc
USB cable	1 pc
Couplant	1 bottle

OPTIONAL ACCESSORY

Transducer	refer to the specification of transducers
Couplant (for ISU-H3M-P12)	ISU-HT5-COUPPLANT
Thermal printer (with cable)	ISU-800D-PRINTER

SPECIFICATION OF TRANSDUCERS (ON STEEL)

Code	Type	Freq	Diameter (Ød)	Measuring range	Min. size of pipes (diameter x wall thickness)	Accuracy	Working temperature	Application
ISU-S15-P06 (Included)	single element	15MHz	8mm	I-E: 0.9~28mm E-E: 0.15~14mm	Ø10x1.5mm Ø15x0.35mm	±0.02mm/0.3%H* (take the larger one)	-10~60°C	high precision or thin workpieces
ISU-S15-P06-CB (optional)**	-	-	5mm	I-E: 0.9~10mm E-E: 0.15~5mm	Ø10x1.2mm Ø15x0.35mm			high precision or Irregular surface
ISU-S15-P06-CB1 (optional)**	-	-	8mm	I-E: 0.9~38mm E-E: 0.3~19mm	-			high precision or thick workpieces
ISU-S2M-P14 (optional)	single element	2MHz	19mm	I-E: 30~2000mm E-E: 30~1000mm	-	±0.5%H*	-10~310°C	ultra-thick workpieces
ISU-G5M-P10 (optional)	dual element	5MHz	13mm	0.8~300mm	Ø25x3mm	±0.04mm (range: <10mm) ±H/333mm* (range: ≥10mm)	-10~60°C	normal workpieces
ISU-G5M-P08 (optional)	dual element	5MHz	11mm	0.8~225mm	Ø20x1.2mm			curved surface and normal workpieces
ISU-G7M-P06 (optional)	dual element	7.5MHz	9mm	0.8~50mm	Ø15x1.2mm			curved surface and small workpieces
ISU-G2M-P12 (optional)	dual element	2MHz	17mm	3~700mm	Ø30x4mm			castings and thick workpieces
ISU-H3M-P12 (optional)	dual element	3MHz	15mm	2~200mm	Ø25x3mm	±0.05mm/0.5%H* (take the larger one)	-10~310°C	workpieces with high temperature

* H is the measured thickness in mm

** Delay blockers, suitable for transducer **ISU-S15-P06**

ULTRASONIC THICKNESS GAGE CODE ISU-720D

DATA
OUTPUT

WITH A AND B SCAN

PENETRATE NON-METALLIC COATING AND
MEASURE THE THICKNESS OF METAL SUBSTRATES

- Two measuring modes, Echo-Echo (E-E) and Transmit-Echo (T-E):
 - E-E is applicable for non-metallic coating (such as paint, plastic resin, etc.) on metal substrates, can penetrate coating and measure the thickness of substrates
 - T-E is to measure the thickness of material without coating, such as metal, plastic, glass, nylon, resin, ceramics, ice, etc.
- A scan, through the waveform, judges whether there are impurities, pores, cracks and so on inside, in order to avoid wrong measurement
- B scan, measures continuously, displays the thickness change on the screen
- Transducers can be automatically identified and zeroed
- Memory 10000 measurement values
- Data can be input to Excel and Word as keyboard signal
- Automatic or manual measurement
- When transducers are removed from workpieces, the measurement data are held on screen for easy viewing
- Set upper and lower limits for alarm when out-of-tolerance
- Automatic power off



SPECIFICATION (ON STEEL)

Measuring range	refer to specification of transducers
Resolution	0.1/0.01mm
Accuracy	±0.04mm (H<10mm) ±(0.04+H/1000)mm (10≤H<100mm) ±H/333mm (H≥100mm) H is the thickness to be measured in mm
Frequency	refer to specification of transducers
Display	320×240, color screen display
Velocity	1000~9999m/s
Measuring frequency	2 times/second and 10 times/second
Operation temperature of main unit	-20~50°C
Output	USB
Measuring unit	mm/inch
Power supply	2×1.5V AA batteries
Dimension	133×75×29mm
Weight	260g (including batteries)

STANDARD DELIVERY

Main unit	1 pc
Bicrystal transducer ISU-T07	1 pc
Battery (AA)	2 pcs
Couplant	1 bottle
USB cable	1 pc

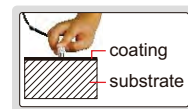

Echo-Echo mode (E-E)

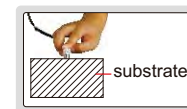

Transmit-Echo mode (T-E)



transducer ISU-T04 (optional)



transducer ISU-T06 (optional)



transducer ISU-T08 (optional)



transducer ISU-T12 (optional)



transducer ISU-T13 (optional)



transducer ISU-T25 (optional)



OPTIONAL ACCESSORY

Transducer	ISU-T04, ISU-T06, ISU-T08, ISU-T12, ISU-T13, ISU-T25
Couplant (for ISU-T13)	ISU-HT5-COULPLANT

SPECIFICATION OF TRANSDUCERS (ON STEEL)

Code	Mode	Frequency	Diameter (Ød)	Measuring range	Minimum size of pipes for measurement (diameter × wall thickness)	Applicable temperature	Application
ISU-T07 (included)	T-E E-E	5.0MHz	13.2mm	T-E mode: 1.5~200mm E-E mode: 3~25mm	T-E mode: Ø25×3mm	-20~60°C	general use
ISU-T04 (optional)	T-E	10.0MHz	6mm	0.7~20mm	Ø15×1mm	-20~60°C	for small tubes
ISU-T06 (optional)	T-E	7.5MHz	9mm	0.7~50mm	Ø15×1.2mm	-20~60°C	for thin workpieces
ISU-T08 (optional)	T-E	5.0MHz	11mm	0.8~300mm	Ø25×1.2mm	-20~60°C	general use
ISU-T12 (optional)	T-E	2.0MHz	17mm	2~400mm	Ø40×3mm	-20~60°C	for casting iron
ISU-T13 (optional)	T-E	5.0MHz	15mm	3~100mm	Ø25×2mm	0~350°C	for high temperature
ISU-T25 (optional)	T-E	1.0MHz	26mm	3~200mm	-	-20~60°C	for fiberglass and organic material



DATA
OUTPUT

WITH A AND B SCAN

ULTRASONIC THICKNESS GAGE (FOR THICK WORKPIECES MADE OF ORGANIC MATERIALS) CODE ISU-710D



- For thick workpieces made of organic materials
- A scan, through the waveform, judges whether there are impurities, pores, cracks and so on inside, in order to avoid wrong measurement
- B scan, measures continuously, displays the thickness change on the screen
- Transducers can be automatically identified and zeroed
- Memory 10000 measurement values
- Data can be input to Excel and Word as keyboard signal
- Automatic or manual measurement
- When transducers are removed from workpieces, the measurement data are held on screen for easy viewing
- Set upper and lower limits for alarm when out-of-tolerance
- Automatic power off

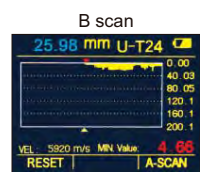
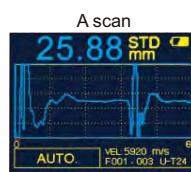

SPECIFICATION (ON STEEL)

Measuring range		20~590mm
Resolution		0.1/0.01mm
Accuracy		±(0.04+H/1000)mm (H<100mm) ±H/333mm (H≥100mm) H is the thickness to be measured in mm
Transducer	type	single element transducer
	frequency	1.0MHz
	diameter (Ød)	26mm
Display		320×240, color screen display
Velocity		1000~9999m/s
Measuring frequency		2 times/second and 10 times/second
Operation temperature		main unit: -20~50°C transducer: -20~60°C
Output		USB
Measuring unit		mm/inch
Power supply		2×1.5V AA batteries
Dimension		133×75×29mm
Weight		260g (including batteries)

STANDARD DELIVERY

Main unit	1 pc
Transducer	1 pc
Battery (AA)	2 pcs
Couplant	1 bottle
USB cable	1 pc

ULTRASONIC THICKNESS GAGE (FOR THIN WORKPIECES) CODE ISU-700D

DATA
OUTPUT

WITH A AND B SCAN



- For thin workpieces
- A scan, through the waveform, judges whether there are impurities, pores, cracks and so on inside, in order to avoid wrong measurement
- B scan, measures continuously, displays the thickness change on the screen
- Transducers can be automatically identified and zeroed
- Memory 10000 measurement values
- Data can be input to Excel and Word as keyboard signal
- Automatic or manual measurement
- When transducers are removed from workpieces, the measurement data are held on screen for easy viewing
- Set upper and lower limits for alarm when out-of-tolerance
- Automatic power off

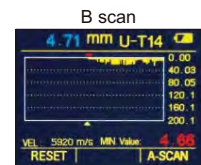
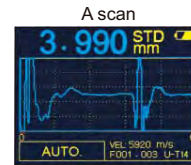

SPECIFICATION (ON STEEL)

Measuring range		Transmit-echo (T-E) mode: 1.5~20mm Echo-echo (E-E) mode: 0.2~10mm
Resolution		0.1/0.01/0.001mm
Accuracy		±0.04mm (H<10mm) ±(0.04+H/1000)mm (H≥10mm) H is the thickness to be measured in mm
Transducer	type	single element transducer
	frequency	15.0MHz
	diameter (Ød)	7.5mm
Display		320×240, color screen display
Velocity		1000~9999m/s
Measuring frequency		2 times/second and 10 times/second
Operation temperature		main unit: -20~50°C transducer: -20~60°C
Output		USB
Measuring unit		mm/inch
Power supply		2×1.5V AA batteries
Dimension		133×75×29mm
Weight		260g (including batteries)

transducer protective sleeve (included)



STANDARD DELIVERY

Main unit	1 pc
Transducer	1 pc
Transducer protective sleeve	1 pc
Battery (AA)	2 pcs
Couplant	1 bottle
USB cable	1 pc

PENETRATE NON-METALLIC COATING AND MEASURE THE THICKNESS OF METAL SUBSTRATE



DATA OUTPUT

INSPECTION CERTIFICATE

ULTRASONIC THICKNESS GAGE (THROUGH COATING) CODE ISU-300D

- Two measuring modes, Echo-Echo (E-E) and Transmit-Echo (T-E):
 - E-E is applicable for non-metallic coating (such as paint, plastic resin, etc.) on metal substrates, can penetrate coating and measure the thickness of substrates
 - T-E is to measure the thickness of material without coating, such as metal, plastic, glass, nylon, resin, ceramics, ice, etc.
- Tolerance measurement
- Average calculation of maximum 9 readings
- Data can be input to Excel and Word as keyboard signal



SPECIFICATION (ON STEEL)

Measuring range	refer to specification of transducers
Resolution	0.1/0.01mm
Accuracy	±0.04mm (H<10mm) ±(0.04+H/1000)mm (10≤H<100mm) ±H/333mm (H≥100mm) H is the thickness to be measured in mm
Velocity	1000~9999m/s
Operation temperature of main unit	-20~50°C
Output	USB
Measuring unit	mm/inch
Power supply	2×1.5V AAA batteries
Dimension	116×64×27mm
Weight	220g

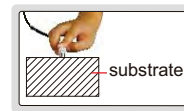

Transmit-Echo mode (T-E)



transducer ISU-T04 (optional)



transducer ISU-T06 (optional)

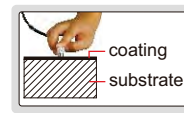

Echo-Echo mode (E-E)



transducer ISU-T12 (optional)



transducer ISU-T13 (optional)

STANDARD DELIVERY

Main unit	1 pc
Transducer ISU-T07	1 pc
Battery (AAA)	2 pcs
Couplant (for ISU-T04, ISU-T06, ISU-T07, ISU-T12)	1 bottle
USB cable	1 pc

OPTIONAL ACCESSORY

Transducer	ISU-T04, ISU-T06, ISU-T12, ISU-T13
Couplant (for ISU-T13)	ISU-HT5-COUPPLANT

SPECIFICATION OF TRANSDUCERS (ON STEEL)

Code	Mode	Frequency	Diameter (Ød)	Measuring range	Minimum size of pipes for measurement (diameter × wall thickness)	Applicable temperature	Application
ISU-T07 (included)	T-E E-E	5.0MHz	13.2mm	T-E mode: 1.5~200mm E-E mode: 3~25mm	T-E mode: Ø25×3mm	-20~60°C	general use
ISU-T04 (optional)	T-E	10.0MHz	6mm	0.7~20mm	Ø15×1mm	-20~60°C	for small tubes
ISU-T06 (optional)	T-E	7.5MHz	9mm	0.7~50mm	Ø15×1.2mm	-20~60°C	for thin workpieces
ISU-T12 (optional)	T-E	2.0MHz	17mm	2~400mm	Ø40×3mm	-20~60°C	for casting iron
ISU-T13 (optional)	T-E	5.0MHz	15mm	3~100mm	Ø25×2mm	0~350°C	for high temperature

ULTRASONIC THICKNESS GAGE CODE ISU-250C

**INSPECTION
CERTIFICATE**

**DATA
OUTPUT**



- Measure the thickness from one side of objects, suitable for pipes, tanks, etc.
- Applicable material: metal, plastic, glass, nylon, resin, ceramic, ice
- Tolerance measurement
- Average calculation of 9 readings
- Data can be input to Excel and Word as keyboard signal



SPECIFICATION (ON STEEL)

Measuring range	refer to specification of transducers
Resolution	0.1/0.01mm
Accuracy	±0.04mm (H<10mm) ±(0.04+H/1000)mm (10≤H<100mm) ±H/333mm (H≥100mm) H is the thickness to be measured in mm
Velocity	1000-9999m/s
Operation temperature of main unit	-20~50°C
Output	USB
Measuring unit	mm/inch
Power supply	2×1.5V AAA batteries
Dimension	64×116×27mm
Weight	220g



transducer ISU-T06 (optional)



transducer ISU-T13 (optional)



transducer ISU-T04 (optional)



transducer ISU-T12 (optional)

STANDARD DELIVERY

Main unit	1 pc
Transducer ISU-T08	1 pc
Battery (AAA)	2 pcs
Couplant (for ISU-T04, ISU-T06, ISU-T08, ISU-T12)	1 bottle
USB cable	1 pc

27

OPTIONAL ACCESSORY

Transducer	ISU-T04, ISU-T06, ISU-T12, ISU-T13
Couplant (for ISU-T13)	ISU-HT5-COULPLANT

SPECIFICATION OF TRANSDUCERS (ON STEEL)

Code	Frequency	Diameter (Ød)	Measuring range	Minimum size of pipes for measurement (diameter × wall thickness)	Applicable temperature	Application
ISU-T08 (included)	5.0MHz	11mm	0.8~300mm	Ø25×1.2mm	-20~60°C	general use
ISU-T04 (optional)	10.0MHz	6mm	0.7~20mm	Ø15×1mm	-20~60°C	for small tubes
ISU-T06 (optional)	7.5MHz	9mm	0.7~50mm	Ø15×1.2mm	-20~60°C	for thin workpieces
ISU-T12 (optional)	2.0MHz	17mm	2~400mm	Ø40×3mm	-20~60°C	for casting iron
ISU-T13 (optional)	5.0MHz	15mm	3~100mm	Ø25×2mm	0~350°C	for high temperature

ATTENTION: NOT SUITABLE FOR CASTINGS AND ALUMINUM WORKPIECES

ULTRASONIC THICKNESS GAGE (BASIC TYPE) CODE ISU-100D

**INSPECTION
CERTIFICATE**



**POPULAR
MODEL**



- Measure the thickness from one side of objects, suitable for pipes, tanks, etc.
- Applicable material: steel, stainless steel, glass, copper, brass, polystyrene, titanium, etc.



SPECIFICATION (ON STEEL)

Measuring range		0.8~300mm
Resolution		0.1/0.01mm
Accuracy		±0.05mm (H<10mm) ±(0.05+H/1000)mm (10≤H<100mm) ±H/333mm (H≥100mm) H is the thickness to be measured in mm
Transducer	frequency	5MHz
	diameter (∅d)	10.8mm
Minimum size of pipes		20×1.2mm (diameter×wall thickness)
Velocity		1000-9999m/s
Operation temperature		main unit: -20~50°C transducer: -20~60°C
Measuring unit		mm/inch
Power supply		2×AAA batteries
Dimension		114×64×28mm
Weight		200g

STANDARD DELIVERY

Main unit	1 pc
Transducer	1 pc
Couplant	1 bottle
Battery (AAA)	2 pcs

STANDARD TEST BLOCKS FOR ULTRASONIC THICKNESS GAGES



STEP WEDGE BLOCKS CAN BE CUSTOMIZED



cylinder block

Cylinder block set (17 blocks are included) (mm)

Code	Material	Diameter	Thickness	Accuracy	QTY
ISU-ST	45#	Ø20	0.5	±0.01	1 pc
	45#	Ø20	1		1 pc
	45#	Ø20	1.2		1 pc
	45#	Ø20	1.5		1 pc
	45#	Ø20	2		1 pc
	45#	Ø20	3.3		1 pc
	45#	Ø20	5.5		1 pc
	45#	Ø20	7.7		1 pc
	45#	Ø20	10		1 pc
	45#	Ø20	15		1 pc

- Supplied with manufacturer inspection certificate
- Material of step wedge blocks can be customized

Cylinder block set (17 blocks are included) (mm)

Code	Material	Diameter	Thickness	Accuracy	QTY
ISU-ST	45#	Ø20	20	±0.02	1 pc
	45#	Ø20	25		1 pc
	45#	Ø20	50		1 pc
	45#	Ø20	75		1 pc
	45#	Ø20	100		1 pc
ISU-ST	45#	Ø20	150	±0.05	1 pc
	45#	Ø20	200		1 pc



round tube block

Round tube block set (2 blocks are included) (mm)

Code	Material	Outer diameter	Wall thickness	Accuracy	Length	QTY
ISU-SWT	45#	Ø30	2	±0.02	40	1 pc
	45#	Ø40	3	±0.02	40	1 pc



step wedge block

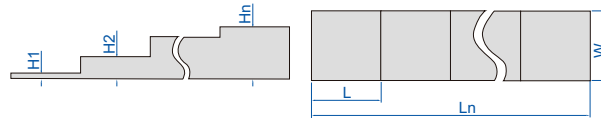

Step wedge blocks

Code	Material	QTY of steps (n)	Thickness							Accuracy	Width (W)	Length of each step (L)	Total length (Ln)
			H1	H2	H3	H4	H5	H6	H7				
ISU-S4A	45#	4	6.25	12.5	18.75	25	-	-	-	±0.02	20	20	80
ISU-S4B	45#	4	5	10	15	20	-	-	-	±0.02	20	20	80
ISU-S5A	45#	5	2.5	5	7.5	10	12.5	-	-	±0.02	20	20	100
ISU-S5B	45#	5	2	4	6	8	10	-	-	±0.02	20	20	100
ISU-S7A	45#	7	3	12.5	24	30	36	42	48	±0.02	40	40	280
ISU-S7B	45#	7	1	1.5	2	4	6	8	10	±0.02	40	40	280

NON-CONTACT TACHOMETER CODE 9223-120

- Accurately measure the rotary speed without contact
- Automatically save the maximum value, minimum value and the last value, 500 data can be stored during continuous measurement

SPECIFICATION

Measuring range	2.5~99999RPM
Resolution	0.1RPM (range 2.5~999.9RPM) 1RPM (range 1000~99999RPM)
Accuracy	±(0.05%n+1d)RPM n is rotary speed, d is resolution
Laser power	CLASS 3R, 3mW~4mW
Sampling time	0.6 second (above 100RPM)
Measuring distance	50~500mm
Operation temperature	0~40°C
Power supply	3×AA batteries
Dimension	180×71×29.9mm
Weight	145g



reflection sticker (included)



STANDARD DELIVERY

Main unit	1 pc
Reflection sticker	3 pcs
Battery (AA)	3 pcs

- Can measure rotary speed, line speed and line length
- Automatically save the maximum value, minimum value and the last value, 96 data can be stored during continuous measurement
- With backlight display

SPECIFICATION

Measuring range	rotary speed	0.5~19999RPM
	line speed	0.05~500m/min
	line length	0.05~99999m
Resolution	rotary speed	0.1RPM (range 0.5~999.9RPM) 1RPM (range 1000~19999RPM)
	line speed	0.01m/min (range 0.05~99.99m/min) 0.1m/min (range 100~500m/min)
	line length	0.02m
Accuracy	rotary speed	$\pm(0.4\%n+1d)$ RPM ($n<300$ RPM) $\pm(0.05\%n+1d)$ RPM ($n\geq 300$ RPM) n is rotary speed, d is resolution
	line speed	$\pm(1\%+1d)$ m/min d is resolution
	line length	$\pm(1\%+1d)$ m d is resolution
Sampling time	0.8s (above 60RPM)	
Operation temperature	0~40°C	
Power supply	3×AA batteries	
Dimension	171×71×35mm	
Weight	162g	



CONTACT TACHOMETER CODE 9224-213



cone cavity head (included)



clamping sleeve (included)



cone head (included)



small cone head (included)

STANDARD DELIVERY

Main unit	1 pc
Wheel with 0.1m perimeter	1 pc
Clamping sleeve	1 pc
Cone head	1 pc
Small cone head	1 pc
Cone cavity head	1 pc
Battery (AA)	3 pcs



wheel with 0.1m perimeter (included)

- 2 measuring method, contact and non-contact
- Can measure rotary speed and line speed
- Automatically save the maximum value, minimum value and the last value, 500 data can be stored during continuous measurement
- Automatic power off

CONTACT/NON-CONTACT TACHOMETER CODE 9225-405



cone head (included)



cone cavity head (included)



reflection sticker (included)



wheel with 0.1m perimeter (included)



small cone head (included)



clamping sleeve (included)

SPECIFICATION

Measuring method	Non-contact	Contact
Measuring range	rotary speed	2.5~99999RPM
	line speed	—
Resolution	rotary speed	0.1RPM (range 2.5~999.9RPM) 1RPM (range 1000~99999RPM)
	line speed	—
Accuracy	rotary speed	$\pm(0.05\%n+1d)$ RPM n is rotary speed, d is resolution
	line speed	—
Laser power	CLASS 3R, 3mW~4mW	
Sampling time	0.6s (above 100RPM)	
Measuring distance	50~500mm	—
Operation temperature	0~40°C	
Power supply	3×AA batteries	
Dimension	206×71×36mm	
Weight	170g	



STANDARD DELIVERY

Main unit	1 pc
Reflection sticker	3 pcs
Wheel with 0.1m perimeter	1 pc
Clamping sleeve	1 pc
Cone head	1 pc
Small cone head	1 pc
Cone cavity head	1 pc
Battery (AA)	3 pcs

DIGITAL LED TACHOMETER/STROBOSCOPE CODE ISQ-TS120K

- Make cyclical motion (rotation, vibration, etc.) objects to appear slow-moving or stationary
- On-line inspection or observation for moving objects
- Measure the rotation or vibration speed and frequency
- Can be triggered from outside by moving objects, make LED flash frequency same as the rotation or vibration

SPECIFICATION

Flash frequency range	60~120000FPM (flash per minute), 1~2000Hz	
Resolution	FPM	0.1FPM (<100000FPM), 1FPM (≥100000FPM)
	HZ	0.01Hz (<200Hz), 0.1Hz (≥200Hz)
Setting accuracy	±0.01%	
Phase shift increment	3°	
Flash pulse duration time	0.1~2.5°	
LED light	3 pcs CREE 10W lamp	
LED life	3~5 years	
Trigger mode	internal and external	
Power supply	built-in rechargeable battery or AC/DC adapter	
Dimension	208×70×60mm	
Weight	380g	

STANDARD DELIVERY

Main unit	1 pc
AC/DC adapter	1 pc
Proximity trigger	1 pc



proximity trigger (included)

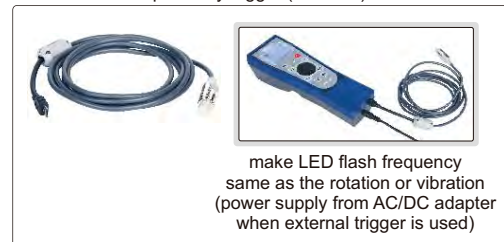

VIBRATION PEN (THREE PARAMETERS) CODE 0020-A199

- Acceleration, velocity and displacement can be tested
- Automatic power off



SPECIFICATION

Parameter	acceleration	velocity	displacement
Measuring range	0.01~199.9m/s ² (peak value)	0.01~199.9mm/s (virtual value)	0.001~1.999mm (peak-peak value)
Frequency	10Hz~1kHz	10Hz~1kHz	10Hz~500Hz
Frequency response	±5% (≥20Hz) -20%~+10% (<20Hz)		
Linearity	±(5%+2unit)		
Indeterminacy of sensitivity	≤3%		
Operation temperature	0°C~40°C/32°F~104°F		
Operation humidity	<85%		
Power supply	2×LR44 battery (for 10 hours working)		
Dimension	150x22x18mm		
Weight	55g		

STANDARD DELIVERY

Main unit	1 pc
LR44 battery	2 pcs

VIBRATION PEN CODE 9720-199

SPECIFICATION

Measured parameter	speed
Measuring range	0.1~199.9mm/s
Frequency	10Hz~1KHz
Accuracy	±(5%±2)mm/s
Operation temperature	0°C~40°C
Operation humidity	<85%
Power supply	2×LR44 batteries (for 10 hours working)
Dimension	150x22x18mm
Weight	55g

- Measure vibration of motors, fans, pumps, compressors and machine tools to prevent mechanical failure
- Small size, light weight, low energy consumption, easy operation, easy to carry
- One key control
- Automatic power off

STANDARD DELIVERY

Main unit	1 pc
LR44 battery	2 pcs



- Quick, easy calibration and checking of vibration measurement, monitoring and recording system

SPECIFICATION

Frequency	159.2Hz±1%
Acceleration	10m/s²±3% (RMS)
Distortion	<5%
Transverse vibration	<5%
Warm-up time	<20s
Maximum load	70g
Mounting thread	M5×0.8mm
Operation temperature	0°C~40°C
Operation humidity	10%RH~90%RH, non-condensing
Power supply	rechargeable lithium battery, working time≥5h
Dimension	∅54.5×147mm
Weight	620g

PORTABLE VIBRATION CALIBRATOR CODE 0021-AS159



M5×0.8mm
thread hole

on/off, the light
for working status



STANDARD DELIVERY

Main unit	1 pc
Power adapter	1 pc



- Auto/manual ranging
- Maximum mode
- Data hold
- NCV detection
- Low battery indication
- Auto power off
- Safety rating: CAT III 600V



test lead (included)



clips (included)

PEN-TYPE DIGITAL MULTIMETER CODE 9241-ML200



STANDARD DELIVERY

Main unit	1 pc
Test lead	1 pc
Clip	2 pcs
Battery (AAA)	2 pcs

SPECIFICATION

Function	Range	Resolution	Accuracy
DC Voltage	200mV/2V/20V/200V/600V	0.1mV/1mV/10mV/0.1V/1V	±(0.7%+2)
	200mV/2V/20V/200V	0.1mV/1mV/10mV/0.1V	±(0.8%+3)
AC Voltage	600V	1V	±(1.0%+3)
DC Current	20mA/200mA	10µA/0.1mA	±(1.5%+3)
AC Current	20mA/200mA	10µA/0.1mA	±(2.0%+3)
Resistance	200Ω	0.1Ω	±(1.0%+3)
	2kΩ/20kΩ/200kΩ/2MΩ	1Ω/10Ω/0.1kΩ/1kΩ	±(1.0%+1)
	20MΩ	10kΩ	±(1.0%+5)
Logic level test	<1.5V (green LED on); 1.5~3.5V (green & red LED off); >3.5V (red LED on)		
Diode	open circuit voltage 1.5V		
Continuity buzzer	<50Ω		
Power supply	2×1.5V AAA batteries		

DIGITAL MULTIMETER CODE 9216-F520



- 2000 counts digital display
- Auto ranging (except 200mV AC)
- Data hold
- Max hold
- Display with backlight
- Low battery indication
- Auto power off
- Safety rating: CAT III 600V

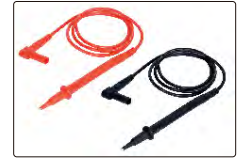

test leads (included)



temperature probe and adapter (included)

SPECIFICATION

Function	Range	Resolution	Accuracy ("d" is the least reading)
DC Voltage	200mV	0.1mV	$\pm(0.5\%+2d)$
	2V/20V/200V	0.001V/0.01V/0.1V	$\pm(1.0\%+2d)$
	600V	1V	$\pm(1.2\%+2d)$
AC Voltage (50~60Hz)	200mV	0.1mV	$\pm(1.5\%+30d)$
	2V	0.001V	$\pm(1.2\%+3d)$
	20V/200V	0.01V/0.1V	$\pm(1.5\%+3d)$
DC Current	600V	1V	$\pm(2.0\%+4d)$
	200μA	0.1μA	$\pm(1.0\%+3d)$
	2000μA/20mA/200mA	1μA/0.01mA/0.1mA	$\pm(1.5\%+3d)$
AC Current (50~60Hz)	10A	0.01A	$\pm(2.5\%+5d)$
	200μA	0.1μA	$\pm(1.5\%+5d)$
	2000μA/20mA/200mA	1μA/0.01mA/0.1mA	$\pm(1.8\%+5d)$
Resistance	10A	0.01A	$\pm(3.0\%+7d)$
	200Ω	0.1Ω	$\pm(1.2\%+4d)$
	2kΩ	0.001kΩ	$\pm(1.0\%+2d)$
Temperature (type-K)	20kΩ/200kΩ/2MΩ	0.01kΩ/0.1kΩ/0.001MΩ	$\pm(1.2\%+2d)$
	20MΩ	0.01MΩ	$\pm(2.0\%+3d)$
	-50°C to 1000°C	1°C	$\pm(3.0\%+5°C)$
Diode test	-58°F to 1832°F	1°F	$\pm(3.0\%+8°F)$
Continuity check	test current: 0.3mA typical	1mV	$\pm(10\%+5d)$
Power supply	less than 100Ω		
Dimension (LxWxH)	9V battery		
Weight	150×70×48mm		
	255g		

STANDARD DELIVERY

Main unit	1 pc
Thermocouple adapter	1 pc
Temperature probe	1 pc
9V battery	1 pc
Test lead	2 pcs

MINI DIGITAL MULTIMETER (BASIC TYPE) CODE 9242-ML100A

- Portable size with protective case
- 2000 counts digital display
- 10A fuse protection
- Low battery indication
- Safety rating: CAT III 600V



test leads (included)



SPECIFICATION

Function	Range	Resolution	Accuracy ("d" is the least reading)
DC Voltage	200mV/2000mV/20V	0.1mV/1mV/0.01V	±(0.5%+2d)
	200V/600V	0.1V/1V	±(1.0%+2d)
AC Voltage (50/60Hz)	200V/600V	0.1V/1V	±(1.2%+10d)
DC Current	2000µA/20mA	1µA/0.01mA	±(1.0%+2d)
	200mA	0.1mA	±(1.2%+2d)
	10A	0.01A	±(2.0%+2d)
Resistance	200Ω/2000Ω/20kΩ/200kΩ	0.1Ω/1Ω/0.01kΩ/0.1kΩ	±(0.8%+2d)
	2000kΩ	1kΩ	±(1.0%+2d)
Battery test	9V	0.01V	±(1.0%+2d)
	1.5V	0.001V	±(1.0%+2d)
Diode test	open circuit voltage 2.8V DC		
Continuity check	<30Ω		
Power supply	1×9V 6F22 battery		
Dimension (LxWxH)	122×61×40mm		
Weight	150g		

STANDARD DELIVERY

Main unit	1 pc
Test lead	2 pcs
9V battery	1 pc



test leads (included)



SMART DIGITAL MULTIMETER CODE 9247-190

STANDARD DELIVERY

Main unit	1 pc
Test lead	2 pcs
Battery (CR2032)	2 pcs

- Automatically identify test modes for AC voltage/DC voltage/resistance/continuity
- NCV detection and judge the strength by light and buzzer
- Self-calibration when power on to ensure accuracy
- LIVE firewire recognition
- Display with backlight
- True RMS measurement
- Data hold
- Low battery indication
- Auto power off
- Safety rating: CAT III 600V

SPECIFICATION

Function	Range	Resolution	Accuracy
DC Voltage	60mV/600mV/6V/60V/600V	0.01mV/0.1mV/0.001V/0.01V/0.1V	±(0.5%+3)
AC Voltage	60mV/600mV/6V/60V/600V	0.01mV/0.1mV/0.001V/0.01V/0.1V	±(1.0%+3)
DC Current	6000µA/60mA/600mA	1µA/0.01mA/0.1mA	±(1.2%+5)
AC Current	6000µA/60mA/600mA	1µA/0.01mA/0.1mA	±(1.5%+5)
Resistance	600Ω/6kΩ/60kΩ/600kΩ	0.1Ω/0.001kΩ/0.01kΩ/0.1kΩ	±(1.0%+5)
	6MΩ/60MΩ	0.001MΩ/0.01MΩ	±(1.5%+3)
Capacitance	6nF/60nF/600nF/6µF/60µF/600µF	0.001nF/0.01nF/0.1nF/0.001µF/0.01µF/0.1µF	±(4.0%+5)
	6mF/60mF	0.001mF/0.01mF	±(5.0%+5)
Frequency	10Hz/100Hz/1000Hz/10kHz/100kHz/1000kHz	0.001Hz/0.01Hz/0.1Hz/0.001kHz/0.01kHz/0.1kHz	±(1.0%+5)
	10MHz	0.001MHz	±(3.0%+5)
Duty cycle	1~99%	0.1%	±(3.0%+5)
Diode measurement	open circuit voltage 2.0V		
Continuity measurement	<50Ω		
Power	2×3V CR2032 batteries		
Dimension (LxWxH)	133×68×18mm		
Weight	178g		

DIGITAL MULTIMETER (WITH JACK INDICATOR LIGHT) CODE 9246-180



- Jack indicator light: jacks flash green to indicate the corresponding jacks for test leads
- NCV detection and judge the strength by light and buzzer
- Self-calibration when power on to ensure accuracy
- LIVE firewire recognition
- Double color backlight (orange backlight prompts high voltage or current: the orange backlight automatically lights up when voltage is higher than 80V or the current is higher than 1A)
- Large range capacitance meter 100mF
- True RMS measurement
- Battery test function
- Max/Min mode
- Data hold
- Low battery indication
- Auto power off
- Safety rating: CAT III 1000V, CAT IV 600V



test leads (included)

STANDARD DELIVERY

Main unit	1 pc
Test lead	2 pcs
Battery (AA)	2 pcs

SPECIFICATION

Function	Range	Resolution	Accuracy
DC Voltage	600mV/6V/60V/600V/1000V	0.1mV/0.001V/0.01V/0.1V/1V	±(0.5%+3)
AC Voltage	6V/60V/600V/750V	0.001V/0.01V/0.1V/1V	±(0.8%+5)
DC Current	60μA/60mA/600mA/10A	0.01μA/0.01mA/0.1mA/0.01A	±(1.2%+3)
AC Current	60mA/600mA/10A	0.01mA/0.1mA/0.01A	±(1.5%+3)
Resistance	600Ω/6kΩ/60kΩ/600kΩ	0.1Ω/0.001kΩ/0.01kΩ/0.1kΩ	±(1.0%+3)
	6MΩ/60MΩ	0.001MΩ/0.01MΩ	±(1.5%+3)
Capacitance	10nF/100nF/1000nF/10μF/100μF/1000μF	0.001nF/0.01nF/0.1nF/0.001μF/0.01μF/0.1μF	±(4.0%+5)
	10mF/100mF	0.001mF/0.01mF	±(5.0%+5)
Frequency	10Hz/100Hz/1000Hz/10kHz/100kHz/1000kHz	0.001Hz/0.01Hz/0.1Hz/0.001kHz/0.01kHz/0.1kHz	±(1.0%+3)
	10MHz	0.001MHz	±(3.0%+3)
Duty cycle	1~99%	0.1%	±(3.0%+3)
Diode measurement	forward DC current 2.5mA, reverse DC voltage 3.0V		
Continuity measurement	<30Ω		
Power	2x1.5V AA batteries		
Dimension (LxWxH)	188×88×50mm		
Weight	424g		

DIGITAL AC/DC CLAMP METER CODE 9315-CF210

- 4000 counts LCD display
- 30mm jaw opening
- True RMS measurement
- NCV detection
- REL (zero) function
- Data hold
- Low battery indication
- Auto power off
- Safety rating: CAT III 600V



test leads (included)



temperature probe and adapter (included)

SPECIFICATION

Function	Range	Resolution	Accuracy ("d" is the least reading)
AC Current (50/60Hz) *	40A	0.01A	±(2.5%+8d)
	400A	0.1A	±(2.8%+5d)
DC Current	40A	0.01A	±(2.5%+5d)
	400A	0.1A	±(2.8%+5d)
AC Voltage (50-400Hz) **	4V/40V/400V	0.001V/0.01V/0.1V	±(1.5%+5d)
	600V	1V	±(2.0%+5d)
DC Voltage	400mV	0.1mV	±(0.8%+2d)
	4V/40V/400V	0.001V/0.01V/0.1V	±(1.5%+2d)
	600V	1V	±(2.0%+2d)
Resistance	400Ω	0.1Ω	±(1.0%+4d)
	4kΩ/40kΩ/400kΩ	0.001kΩ/0.01kΩ/0.1kΩ	±(1.5%+2d)
	4MΩ	0.001MΩ	±(2.5%+3d)
	40MΩ	0.01MΩ	±(3.5%+5d)
Capacitance	40nF	0.01nF	±(4.0%+20d)
	400nF/4μF/40μF	0.1nF/0.001μF/0.01μF	±(3.0%+5d)
	400μF	0.1μF	±(4.0%+10d)
	4mF	0.001mF	±(5.0%+10d)
Frequency	10Hz/100Hz/1kHz/10kHz	0.01Hz/0.1Hz/0.001kHz/0.01kHz	±(1.2%+2d)
Duty cycle	0.5% to 99.0%	0.1%	±(1.2%+2d)
Temperature (type-K)	-20°C to 760°C	1°C	±(3.0%+5°C)
	-4°F to 1400°F	1°F	±(3.0%+9°F)
Power supply	2x1.5V AAA batteries		
Dimension (LxWxH)	210x75x45mm		
Weight	255g		

STANDARD DELIVERY

Main unit	1 pc
Thermocouple adapter	1 pc
Temperature probe	1 pc
Battery (AAA)	2 pcs
Test lead	2 pcs

* All AC current/voltage ranges are specified from 5% to 100% of range

** AC voltage bandwidth: 50 to 400Hz (sine); 50 to 60Hz (all waves)

AC PHASE AND VOLTAGE DETECTOR CODE 9723-400

- Non-contact detection of phase sequence, high and low voltage, wire distinction
- Low battery indication
- Auto power off
- Flashlight

SPECIFICATION

Phase sequence detection	screen shows clockwise or counterclockwise
High and low voltage detection	beep: slow~fast backlight: green~red analog bar: low~high
Wire distinction	green backlight indicates neutral wire red backlight indicates live wire
Power supply	2×1.5V AAA batteries
Dimension	157×27×23mm
Weight	32g



DIGITAL VOLTAGE TESTER CODE 9721-250

- Direct AC test (contact): 12-250V
two way display: voltage displays on LCD screen and neon lamp lights up (when voltage>80V)
- Induction AC test (non-contact): 12-250V
to detect power source or recognize the phase line, ground line and break point
- Direct DC test (contact): 6-36V
instant sense and display
- Work without battery
- Tester tip: CRV material

SPECIFICATION

Range	AC: 12-250V; DC: 6-36V
Neon lamp life	30000 times
Dimension	133×21×19mm
Weight	22g



VOLTAGE TESTER CODE 9722-250

- Tester tip: CRV material

SPECIFICATION

Range	AC: 100-250V
Neon lamp life	30000 times
Dimension	145×Ø15mm
Weight	21g





LASER DISTANCE METERS

- High accuracy models: **9561-50B, 9561-70B**
- Low accuracy models: **9561-50B-F, 9561-70B-F**
- Large display with backlight
- Unit: m, ft, in, ft+in
- Distance, area, volume and height measurement
- Continuous measuring mode to track maximum and minimum value
- Memory of 30 measurement values
- Automatic power off: laser 30s, main unit 180s

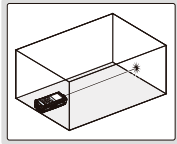

distance measurement

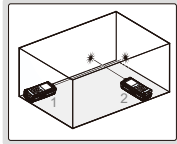

area measurement

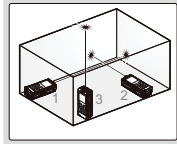

volume measurement

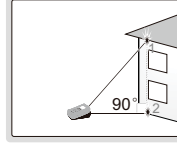

height measurement



9561-50B

SPECIFICATION

Code	9561-50B	9561-70B	9561-50B-F	9561-70B-F
Measuring range	0.2~50m	0.2~70m	0.2~50m	0.2~70m
Resolution	0.001m, .001ft, 1/16"			
Accuracy	$\pm(3+D/20)$ mm D: measured distance, unit: m		$\pm(5+D/20)$ mm D: measured distance, unit: m	
Laser type	630~670nm, class II, <1mW			
Power supply	2×AAA batteries			
Dimension (L×W×H)	115×50×28mm			
Weight	95g			

STANDARD DELIVERY

Main unit	1 pc
Battery (AAA)	2 pcs

IP65
WATERPROOF

PORTABLE CONDUCTIVITY/TDS METER CODE 0411-0200

- Reading mode: auto-read and continuous-read
- Automatic/manual temperature compensation
- Auto-hold feature senses and locks the measurement endpoint
- Cell constant is settable
- 1 point calibration with standard recognition
- Data capacity up to 200 sets for each parameter
- IP65 dust/waterproof
- Auto power off



wristband (included)



standard solution (included)



SPECIFICATION

Conductivity	range	0.00μS/cm~200mS/cm
	resolution	0.01μS/cm minimum
	accuracy	±1.0%FS
	reference temperature	25°C/77°F
	calibration point	1
	standard recognition	84μS/cm, 1413μS/cm, 12.88mS/cm
TDS	range	0.00mg/L~300g/L
	resolution	0.01mg/L minimum
	accuracy	±1.0%FS
Temperature	range	-5~110°C/23~230°F
	resolution	0.1°C/0.2°F
	accuracy	±0.2°C/±0.4°F
Input	electrode with 5-pin aviation connector	
Power supply	rechargeable battery	
Dimension	80×225×35mm	
Weight	400g	



STANDARD DELIVERY

Main unit	1 pc
Electrode	1 pc
Electrode holder	2 pcs
Wristband	1 pc
Silicone rubber case	1 pc
AC/DC adapter and charging cable	1 pc
Standard solution	1 bottle

PORTABLE pH METER CODE 0431-0018

IP65
WATERPROOF



standard solution (included)



wristband (included)



KCl powder (included)

- Reading mode: auto-read and continuous-read
- Automatic/manual temperature compensation
- Auto-hold feature senses and locks the measurement endpoint
- 1 or 2 points calibration with standard recognition
- Data capacity up to 200 sets for each parameter
- IP65 dust/waterproof
- Auto power off



SPECIFICATION

pH	range	-2.00~18.00pH
	resolution	0.01pH
	accuracy	±0.01pH
	calibration point	1 or 2
	standard recognition	NIST pH buffers: 4.01, 7.00, 10.01
Voltage	range	-1999~1999mV
	resolution	1mV
	accuracy	±0.1%FS
Temperature	range	-5~110°C/23~230°F
	resolution	0.1°C/0.2°F
	accuracy	±0.2°C/±0.4°F
Inputs	pH electrode: BNC (Q9) temp. probe: 4-pin aviation connector	
Power supply	rechargeable battery	
Dimension	80×225×35mm	
Weight	400g	

STANDARD DELIVERY

Main unit	1 pc
Electrode	1 pc
Electrode holder	2 pcs
Wristband	1 pc
Silicone rubber case	1 pc
AC/DC adapter and charging cable	1 pc
Standard solution	3 bottles
KCl powder	1 bottle

DIGITAL REFRACTOMETER CODE ISQ-DRM31

SUITABLE FOR WATER
BASED COOLANT

- Quickly measure the concentration of coolant, sugar solution, juice and drinks
- Two measurement modes: single measurement and automatic average multiple measurement
- Two units: brix and refractive index
- Refer to the refraction factor of coolant, for example: the refraction factor of grinding emulsion is 2.1, the reading value is 6%, so the actual concentration is $(2.1 \times 6\%) = 12.6\%$
- Automatic power off



SPECIFICATION

Measuring range	0~50% (1.3330~1.4200RI)
Accuracy	±0.2% (±0.0003RI)
Resolution	0.1% (0.0001RI)
Power supply	1×AAA battery
Dimension	121×58×25mm
Weight	90g

STANDARD DELIVERY

Main unit	1 pc
Dropper	1 pc
Battery (AAA)	1 pc

dropper (included)



MINI DIGITAL REFRACTOMETER CODE 5801-A55

SUITABLE FOR WATER
BASED COOLANT

- Quickly measure the concentration of coolant
- Automatic temperature compensation
- Brix and refractive index can be displayed
- Refer to the refraction coefficient of coolant, for example: the refraction coefficient of grinding emulsion is 2.1, the reading value is 6%, so the actual concentration is $(2.1 \times 6\%) = 12.6\%$
- Automatic power off



SPECIFICATION

Measuring range	0~50% (1.3330~1.4200RI)
Accuracy	±0.2% (±0.0003RI)
Resolution	0.1% (0.0001RI)
Power supply	built-in 3.7V rechargeable lithium battery
Dimension	147×46×27mm
Weight	115g (including battery)

STANDARD DELIVERY

Main unit	1 pc
Dropper	1 pc

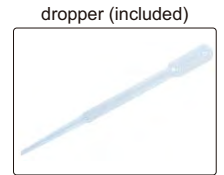

SUITABLE FOR WATER
BASED COOLANT

PORTABLE REFRACTOMETER CODE ISQ-RM30

- Quickly measure the concentration of coolant
- Refer to the refraction factor of coolant, for example: the refraction factor of grinding emulsion is 2.1, the reading value is 6%, so the actual concentration is $(2.1 \times 6\%) = 12.6\%$

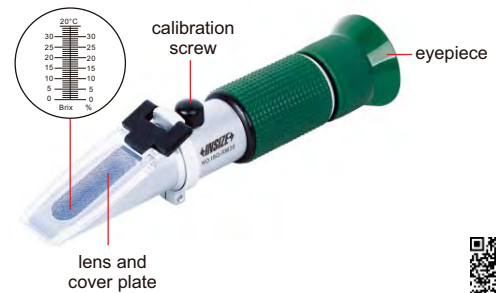

SPECIFICATION

Measuring range	0~32%
Graduation	0.2%
Dimension	27×40×160mm
Weight	175g



PORTABLE REFRACTOMETER FOR AUTOMOTIVE LIQUID CODE 5802-A510

- Measure the freezing point of the antifreeze and the concentration of urea in diesel exhaust fluid
- Measure the specific gravity of battery fluid

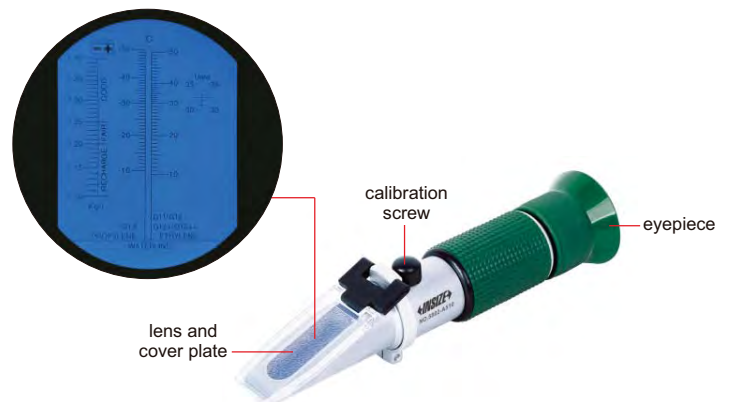

SPECIFICATION

Measuring object	ethylene glycol	propylene glycol	urea	battery fluid
Measuring range	-50~0°C	-50~0°C	30~35%	1.10~1.40kg/l
Accuracy	±5°C	±5°C	±1%	±0.02kg/l
Resolution	1°C	1°C	1%	0.01kg/l
Dimension	27x40x160mm			
Weight	172g			

PORTABLE REFRACTOMETER FOR DIESEL EXHAUST FLUID CODE 5803-B40

- Measure the concentration of urea in diesel exhaust fluid
- Wide measuring range

SPECIFICATION

Measuring range	0~40%
Accuracy	±0.2% (20°C)
Resolution	0.2%
Dimension	27x40x160mm
Weight	170g

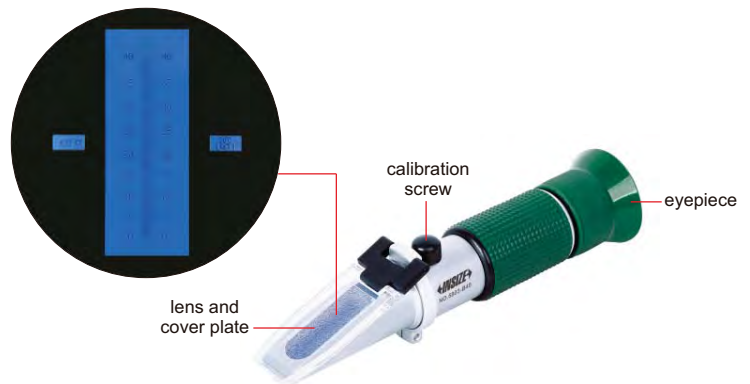

DIGITAL STOPWATCH CODE DSW-A010

- Split time, total time and continuous time can be displayed
- 10 groups of results can be read out from memory after resetting
- Scroll back and forth to read out the memory digits
- The fastest, slowest and average time can be displayed
- Able to record the split times (00-199)

SPECIFICATION

Measuring range	0~9 hours, 59 minutes, 59.99 seconds	
Resolution	0.01s	
Accuracy	±0.5s	
Function	memory	10 groups
	timer	up to 10 hours
	time	12-hour or 24-hour time display, alarm can be set
Power supply	LR44 battery	
Screen dimension	33.6×13.6mm	
Dimension	76×63×16mm (metal case)	



STANDARD DELIVERY

Main unit	1 pc
String	1 pc

STROKE COUNTER CODE 7600-6

- Accumulate and record the number of mechanical movements
- Rotate back to zero



SPECIFICATION

Code	Number of digits	Range
7600-6	6	0-999999

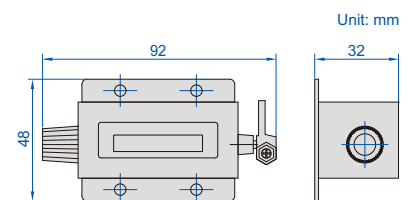



DIGITAL MOISTURE METER CODE 9341-50

- Suitable for wood, smooth cement, hard gypsum, mixed mortar, brick, etc.
- Measure moisture, temperature and relative humidity
- Temperature type: ambient, dew point, wet bulb
- Maximum and minimum modes
- Automatic power off

SPECIFICATION

Measuring depth		0~50mm
Measuring range	moisture	0~60%
	temperature	-10~50°C/14~122°F
	relative humidity	0~100%RH
Accuracy	moisture	±2%
	temperature	±2%
	relative humidity	±5%RH
Resolution	moisture	0.1%
	temperature	0.1°C/0.1°F
	relative humidity	0.1%RH
Sampling time		0.5s for moisture 1s for temperature and relative humidity
Power supply		2×AAA batteries
Dimension		130×56×29mm
Weight		206g



STANDARD DELIVERY

Main unit	1 pc
Battery (AAA)	2 pcs

INDUCTIVE MOISTURE METER CODE 0120-IM24

- Suitable for wood, gypsum and cement
- MAX/MIN/HOLD mode
- Alarm function
- Low battery indication
- Auto power off

SPECIFICATION

Measuring range	0~100%
Resolution	1%
Accuracy	±4%
Detection depth	20~40mm
Sampling time	0.5s
Battery	9V
Dimension	185×55×38mm
Weight	193g

STANDARD DELIVERY

Main unit	1 pc
Battery	1 pc



DIFFERENTIAL PRESSURE MANOMETER CODE 0140-DP05

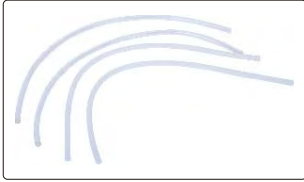

soft tubes (included)



- Offset and differential measurement
- Record maximum/minimum/average value with relative timestamp
- Built-in USB interface for data transmission
- Unit: psi, inH₂O, bar, mbar, kPa, inHg, mmHg, oz/in², ftH₂O, cmH₂O, kg/cm²
- Zero adjust
- Data hold
- Display with backlight
- Low battery indication
- Automatic power off
- Safety rating: CAT III 600V

SPECIFICATION

Pressure range	-5~5psi											
Maximum pressure	20psi											
Unit	psi	inH ₂ O	bar	mbar	kPa	inHg	mmHg	oz/in ²	ftH ₂ O	cmH ₂ O	kg/cm ²	
Range	5	138.3	0.344	344.7	34.47	10.18	258.5	80	11.53	351.5	0.351	
Resolution	0.001	0.1	0.001	0.1	0.01	0.01	0.1	0.01	0.01	0.1	0.001	
Accuracy	±0.3%FSO (25°C)											
Repeatability	±0.2% (Max. ±0.5%FSO)											
Linearity/hysteresis	±0.29%FSO											
Response time	0.5s typical											
Operation temperature	0°C~50°C											
Power supply	1×9V 6F22 battery or AC/DC adapter											
Dimension (LxWxH)	165×90×40mm											
Weight	350g											

27

STANDARD DELIVERY

Main unit	1 pc
AC/DC adapter	1 pc
9V battery	1 pc
Software flash disk	1 pc
USB cable	1 pc
Soft tubes	4 pcs

software (included), connect to PC via USB cable

export data

display realtime value and curve

export data to Excel

ANEMOMETER CODE 0110-1125

- Measure air velocity and temperature
- Min/Max, data hold function
- Bluetooth 4.0
- Auto power off
- Supplied with APP for Apple and Android

App measurement

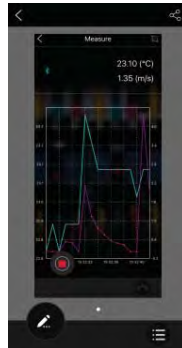

App record

No.	Data Value (°C)	Data Value (m/s)
1	23.10	0.22
2	23.10	0.00
3	23.00	0.00
4	23.10	4.39
5	23.10	1.85
6	23.00	1.06
7	23.00	0.72
8	23.00	10.84



SPECIFICATION

	Unit	Measuring range	Resolution	Accuracy
Air velocity	m/s	1.1~25.0	0.01	±(3%+0.3)
	km/h	4~90	0.1	±(3%+1)
	ft/min	220~4920	1	±(3%+40)
	MPH	2.5~56.0	0.1	±(3%+0.4)
	knots	2.2~48.0	0.1	
Air temperature	°C	0~50	0.1	±2
	°F	32~122	0.1	±4
Sensors	air velocity sensor, NTC-type precision thermistor			
Sampling time	0.5s			
Operation altitude	max 2000m			
Operation environment	0~50°C, 0~80%RH			
Storage environment	-10~60°C, 0~80%RH			
Auto power off	10 minutes			
Data port	bluetooth 4.0			
Power supply	9V			
Dimension	213×54×36mm			
Weight	172g			

STANDARD DELIVERY

Main unit	1 pc
Battery	1 pc

CAN BE
CUSTOMIZED

BOURDON TUBE PRESSURE GAGES (LIQUID FILLED)

- Stainless steel case and bezel, copper alloy internals
- Shock-proof and pulse-proof
- Suitable for pneumatic systems, hydraulic systems and compressed air systems

Dial size	Ø63mm		
Process connection	1/4BSP	1/4ZG	1/4NPT
Connector location	bottom	bottom	bottom
Range (0~10bar/0~150psi)	5201-63B2Y10	5201-63Z2Y10	5201-63N2Y10

SPECIFICATION

Accuracy class	1.6
Ambient temperature	-20~60°C
Medium temperature	≤60°C



5201-63B2Y10

DIGITAL SOUND LEVEL METER (ADVANCED TYPE) CODE 9353-413

- Automatic range conversion
- Over range indicator
- Maximum mode
- Data hold
- AC signal output: 0.707Vrms, impedance approx.100Ω
- DC signal output: 20mV/dB, impedance approx.1kΩ

SPECIFICATION

Measuring range	40dB~130dB (ref.20μPa)
Frequency	20Hz~12.5kHz
Resolution	0.1dB
Accuracy	IEC 61672-1:2013 class 2
Frequency weighting	A weighting
Response time	fast (125ms), slow (1s)
Microphone	pre polarization condenser microphone
Refercner direction	axial direction of condenser microphone
Power supply	4×1.5V AAA batteries
Dimension	210×68×27mm
Weight	240g



STANDARD DELIVERY

Main unit	1 pc
Battery (AAA)	4 pcs
Precision screwdriver	1 pc

SOUND LEVEL METER (BASIC TYPE) CODE 0010-A35

- Auto range selection
- Over range indication
- Display backlight
- Min/Max, data hold function
- Bluetooth 4.0
- Auto power off
- Supplied with APP for Apple and Android

App measurement

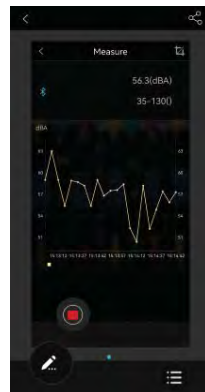

App record

No.	dB(A)	Min	Time
1	58.3	50-100	15:10:49
2	61.2	50-100	15:10:50
3	55.6	30-100	15:10:51
4	59.1	50-100	15:10:52
5	56.7	50-100	15:10:53
6	61.7	50-100	15:10:54
7	64.4	50-100	15:10:55
8	64.8	50-100	15:10:56
9	60.9	50-100	15:10:57



STANDARD DELIVERY

Main unit	1 pc
Battery	1 pc
Windscreen	1 pc

SPECIFICATION

Frequency	31.5Hz~8KHz
Measuring range	35dB~130dB
Accuracy	±3.0dB (ref 94dB@1kHz)
Resolution	0.1dB
Frequency weighting	A and C
Display update	2 times/sec
Microphone	1/2 inch electret condenser microphone
Power supply	9V battery
Operation temperature and humidity	0°C~40°C/32°F~104°F, 10%RH~90%RH
Dimension	185×54×36mm
Weight	184g

DATA OUTPUT

**DIGITAL SOUND LEVEL METER
CODE 9351-130**

- Automatically select best range: 30~80dB, 40~90dB, 50~100dB, 60~110dB, 70~120dB, 80~130dB
- Over range indicator
- Real time, average, maximum modes
- Memory 16000 measurement values
- AC signal output: 0.707 Vrms at FS, impedance approx. 600Ω
- DC signal output: 10mV/dB, impedance approx. 100Ω
- Automatic power off

SPECIFICATION

Measuring range	30~130dB
Accuracy	±2dB
Resolution	0.1dB
Sampling time	0.5s for digital, 0.05s for analogue
Response time	fast: 125ms, slow: 1s
Frequency	30Hz~8KHz
Frequency weighting	A/C
Microphone	electret condenser type
Output	RS232, AC/DC
Power supply	6×AAA batteries
Dimension	265×80×69mm
Weight	317g



software flash disk (included)



VIDEO

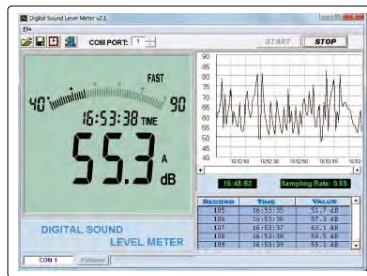

software (included), display measurement values and graph, save and output data

STANDARD DELIVERY

Main unit	1 pc
Software and RS232 cable	1 pc
Output connector	1 pc
Battery (AAA)	6 pcs

**LIGHT METER
CODE 0131-A120**

- Photosensor can rotate 90° clockwise and 180° counterclockwise
- Build-in calibration filters ensure the accuracy when working in different colors
- Data hold function
- Lux/FC unit switch
- Low battery alarm

SPECIFICATION

Measuring range	0.1~199.9Lux	1~1999Lux	10~19990Lux	100~199900Lux
Resolution	0.1Lux	1Lux	10Lux	100Lux
Measuring range	0.01~19.99FC	0.1~199.9FC	1~1999FC	10~19990FC
Resolution	0.01FC	0.1FC	1FC	10FC
Accuracy	±(4%+10d), range<20000Lux/2000FC ±(5%+10d), range≥20000Lux/2000FC (d is resolution, calibrated with standard incandescent lamp at color temperature 2856K)			
Repeatability	±2%			
Sampling time	0.5s			
Operation environment	0~40°C, 0~70%RH			
Storage environment	-10~50°C, 0~80%RH			
Battery	9V			
Dimension	185×68×38mm			
Weight	130g			

rotate 90° clockwise rotate 180° counterclockwise



STANDARD DELIVERY

Main unit	1 pc
Battery	1 pc

LIGHT METER (BASIC TYPE) CODE 0130-L110

- Suitable for measuring illuminance in various occasions
- Data hold function
- Fast switching of measuring range, easy to operate

SPECIFICATION

Measuring range	1~1999Lux	10~19990Lux	100~100000Lux
Resolution	1Lux	10Lux	100Lux
Accuracy	±(4%+10d), range<10000Lux ±(5%+10d), range≥10000Lux (d is resolution, calibrated with standard incandescent lamp at color temperature 2856K)		
Repeatability	±2%		
Sampling time	0.5s		
Operation environment	0~40°C, 0~70%RH		
Storage environment	-10~50°C, 0~80%RH		
Battery	9V		
Photodetector dimension	105×58×28mm		
Main unit dimension	130×72×30mm		
Weight	170g		



STANDARD DELIVERY

Main unit	1 pc
Battery	1 pc

UV LIGHT METER CODE 0132-UV199

- Self-recognize probes
- Real-time value, maximum value, minimum value, average value, time, energy value are displayed at the same time



MAIN UNIT SPECIFICATION

Display	240×160 LCD
Power supply	4 AAA alkaline batteries
Dimension	148×76×26mm
Weight	194g

STANDARD DELIVERY

Main unit	1 pc
Probe 0132-UVA1	1 pc
Battery	4 pcs



probe
0132-UVA1
(included)

PROBE SPECIFICATION

Probe code	0132-UVA1 (included)	0132-UVC0 (optional)	0132-UVCWP1 (optional)
Application	general purpose low power UVA intensity and energy measurement	intensity and energy measurement of 254nm UV sterilization mercury lamp	intensity and energy measurement of 254nm UV sterilization mercury lamp
Spectral response	$\lambda_p=365\text{nm}$ 315nm-400nm	$\lambda_p=254\text{nm}$ 230nm-280nm	
Power measuring range	0~200000 $\mu\text{W}/\text{cm}^2$		
Resolution	0.1 $\mu\text{W}/\text{cm}^2$		
Energy measuring range	0-9999999 $\mu\text{J}/\text{cm}^2$		
Measuring accuracy	±10%		
Record time	0-99999s		
Sampling speed	6 times/second		
Measuring unit	$\mu\text{W}/\text{cm}^2$ (default), mW/cm^2 , W/m^2		
Test hole diameter	Ø10mm		
Probe size	39×32×15mm	Ø39×15mm	Ø50×20mm
Waterproof depth	—	—	1m

To be continued



Continued from previous page

Probe code	0132-UVLED0 (optional)	0132-UVB0 (optional)	0132-UVA0 (optional)
Application	measurement of 260nm-285nm UV LED sterilization lamp	general purpose UVB intensity and energy measurement	intensity and energy measurement of light source of high pressure mercury lamp in UV curing industry
Spectral response	280nm-315nm *	$\lambda_p=310nm$ ** 280nm-315nm	$\lambda_p=365nm$ 315nm-400nm
Power measuring range	0~200000 $\mu W/cm^2$		0~2000mW/cm ²
Resolution	0.1 $\mu W/cm^2$		0.1mW/cm ²
Energy measuring range	0-9999999 $\mu J/cm^2$		
Measuring accuracy	±10%		
Record time	0-99999s		
Sampling speed	6 times/second		2048 times/second
Measuring unit	$\mu W/cm^2$ (default), mW/cm ² , W/m ²		mW/cm ² (default), W/m ²
Test hole diameter	Ø10mm		
Probe size	Ø39×15mm		39×32×15mm

*Wide spectral range, avoid using in strong light

**Suitable for measuring UVB light source with wavelength 297nm, 308nm, and 313nm

Probe code	0132-UVALED0 (optional)	0132-UVALED1 (optional)	0132-UVALED3 (optional)
Application	intensity and energy measurement of area light source of UV LED in UV curing industry	intensity and energy measurement of point light source of UV LED in UV curing industry	general purpose UVA+UVV LED intensity and energy measurement, low power measuring range
Spectral response	calibrated with 395nm UV LED 340nm-420nm		
Power measuring range	0~20000mW/cm ²		0~200000 $\mu W/cm^2$
Resolution	1mW/cm ²		0.1 $\mu W/cm^2$
Energy measuring range	0-9999999 $\mu J/cm^2$		
Measuring accuracy	±10%		
Record time	0-99999s		
Sampling speed	2048 times/second		6 times/second
Measuring unit	mW/cm ² (default), W/cm ² , W/m ²		$\mu W/cm^2$ (default), mW/cm ² , W/m ²
Test hole diameter	Ø10mm	Ø1mm	Ø10mm
Probe size	39×32×15mm		

- Detect combustible gas (EX, including CH₄, C₃H₈, H₂, etc), O₂, CO or H₂S, support more than 30 types of gas sensors, customization for detecting toxic gases (such as NO, NH₃, PH₃, etc) available
- Adjustable alarm level, alarm mode: sound, light, vibration
- Adjustable calibration level
- Sampling method: natural diffusion
- High concentration protection for sensor
- Up to 500 alarm records storage capacity
- Self-test on startup
- Display with backlight
- Language: English, Chinese
- Low battery indication
- Explosion proof level: Ex ib IIB T3 Gb

IP65
WATERPROOF



calibration cap (included)

SINGLE GAS DETECTORS



0611-SG01

SPECIFICATION

Code	0611-SG01	0611-SG02	0611-SG03	0611-SG04
Gas	combustible gas/EX	O ₂	CO	H ₂ S
Range	0-100%LEL	0-30%vol	0-1000ppm	0-100ppm
Resolution	1%LEL	0.1%vol	1ppm	1ppm
Accuracy	±5%FS			
Response time	T ₉₀ <60s			
Operation environment	temperature: -10°C~55°C; humidity: <95%RH, no condensation			
Sensor lifetime	2 years (depending on working environment)			
Power supply	3.7V rechargeable Li-ion battery, working time>8h			
Dimension (LxWxH)	124×60×46mm			
Weight	205g			

STANDARD DELIVERY

Main unit	1 pc
Calibration cap	1 pc
AC/DC adapter and charging cable	1 pc

MULTI GAS DETECTOR CODE 0612-MG04

DATA
OUTPUT

IP66
WATERPROOF



software flash disk
(included)



charging cable (included)



calibration cap (included)



charging and data transmission
interface on the back

- Detect combustible gas (EX, including CH₄, C₃H₈, H₂, etc), oxygen (O₂), carbon monoxide (CO) and hydrogen sulfide (H₂S), optional configuration includes other toxic gases such as NO, NH₃, PH₃, etc; support more than 30 types of gas sensors, flexible sensor combination and customization available
- Adjustable alarm level, alarm mode: sound, light, vibration and screen display
- Adjustable calibration level
- Sampling method: natural diffusion
- High concentration protection for sensor
- Data transmission via charging interface
- Up to 1000 alarm records storage capacity
- Self-test on startup
- Display with backlight
- Language: English, Chinese and Spanish (Portuguese and Russian customizable)
- Low battery indication
- Explosion proof level: Ex ib IIC T4 Gb

SPECIFICATION

Gas	combustible gas (EX)	O ₂	CO	H ₂ S
Range	0-100%LEL	0-30%vol	0-1000ppm	0-100ppm
Resolution	1%LEL	0.1%vol	1ppm	1ppm
Accuracy	±5%FS			
Response time	T ₉₀ <60s			
Operation environment	temperature: -10°C~50°C; humidity: <95%RH, no condensation			
Sensor lifetime	2 years (depending on working environment)			
Power supply	3.7V rechargeable Li-ion battery, working time>8h			
Dimension (LxWxH)	150×72×48mm			
Weight	310g			

STANDARD DELIVERY

Main unit	1 pc
Calibration cap	1 pc
Software and USB cable	1 pc
AC/DC adapter	1 pc

software (included), connect to PC via USB cable, display test data and export record

display real-time data and alarm record

export history data and alarm record

DATA
OUTPUT



TESLAMETERS (GAUSSMETERS)

- Measure magnetic induction of DC magnetic field
- Directly display the N/S polarity of the measured magnetic field
- One-key zero function: eliminate the influence of zero drift before measurement
- Maximum value hold: record the maximum value of the changing magnetic field
- Unit switch between mT or G (1mT=10G)
- Auto ranging
- Built-in USB interface for data transmission
- Display with backlight
- Auto power off



axial probe (optional)



0501-MA01

radial probe (included)

SPECIFICATION

Code	0501-MA01	0501-MA05
Range	2000mT	
Resolution	0.01mT (0~200mT) 0.1mT (200~2000mT)	
Accuracy	±1.0%	±2.0% (≤1000mT) ±5.0% (1000mT~2000mT)
Temperature coefficient	±0.1%/K	
Zero drift	±0.5mT/h	
Interface	USB	
Power supply	3×1.5V AA batteries or USB	
Dimension (L×W×H)	165×90×40mm	
Weight	350g	

STANDARD DELIVERY

Main unit	1 pc
Radial probe	1 pc
Battery (AA)	3 pcs

OPTIONAL ACCESSORY

Axial probe	0501-PA
-------------	---------

LASER BELT TENSION METER CODE 5900-HZ18

- Laser sensor, direct measurement, easy to use
- Two sensors: internal and external, external sensor is suitable for measurement in narrow spaces
- Automatic power off

SPECIFICATION

Measuring range	10~800Hz	
Input parameter range	maximum free belt length: 99.99m maximum belt weight: 9.999kg/m	
Accuracy	±5%	
Unit	N, lbf	
Measuring distance	3~20mm	
Operation temperature	10~50°C	
Power supply	4×1.5V AAA batteries	
Dimension	main unit	178×72×34mm
	external sensor	124×21×12mm
Weight	180g	

STANDARD DELIVERY

Main unit	1 pc
External sensor	1 pc



external sensor

internal sensor





Infrared Thermal Imaging Cameras
Page 661-662



Infrared Thermometers
Page 662-663



Data Loggers For Temperature And Humidity
Page 664



Thermohygrometers
Page 665-666/668



Large Screen Temperature And Humidity Meters
Page 667



Portable Medium Temperature Dry Block Calibrators
Page 668

NON-CONTACT
TEMPERATURE MEASUREMENT

DATA
OUTPUT

IP54
WATERPROOF

INFRARED THERMAL IMAGING CAMERA (BASIC TYPE) CODE 9132-T400

- IR/visible/laser indicator
- Trigger button for photo taking
- 2-meter drop test, IP54 protection



STANDARD DELIVERY

Main unit	1 pc
Power supply adapter	1 pc
TYPE-C cable	1 pc
16G TF card	1 pc

SPECIFICATION

IR image	IR resolution	120×90@17μm
	detector type	VOx/7.5~14μm
	frame rate	25Hz/9Hz
	thermal sensitivity/NETD	60mk
	focal length	2.28mm/F1.13
	field of view (FOV)	50°×38°
	spatial resolution (IFOV)	7.6mrad
	focus	focus-free
Visible camera	visible camera resolution	320×240, focus-free
	flashlight	yes
Image display	display	2.4 inch IPS technology TFT display
	display resolution	320×240
	image model	IR/visible/picture-in-picture
	color palettes	6: white hot, iron red, hot iron, arctic, rainbow 1, rainbow 2
Temperature measurement	temperature range	-20~150°C, 100~400°C (auto switching)
	accuracy	±2°C or ±3%, whichever is greater (target temp ≥0°C, ambient temp is 15~30°C)
	measurement spot	center spot
	measurement area	3 (incl. max & min temp)
	auto max & min spot tracking	yes
	alarm	full screen max & min spot alarm
Image storage	storage media	TF card (16G)
	IR image format	full radiometric (JPG) (120 x 90)
	visible image	yes, 320x240
Connections & communications	USB	TYPE-C, TF card slot
	tripod interface	yes
	mobile APP	yes
	PC IR analysis software	yes
Power system	battery type	rechargeable li ion battery
	battery operation time	>5 hours
	charging time	internal charge, ≤2.5 hours
Environmental parameters	operation temperature	-10~50°C
	storage temperature	-40~70°C
	protection	IP54, 2-meter drop test
	certification	CE/ROHS/FCC
	dimension (LxWxH)	194×61.5×76mm
weight	350g	

front view



INFRARED THERMAL IMAGING CAMERA CODE 9130-H360

IP54
WATERPROOF

DATA
OUTPUT



- 4 inch high-brightness touchscreen
- Four image presentations: IR, visible, PIP and MIF
- WIFI real-time sharing, one-click connection to mobile devices
- USB interface for data transmission and charging
- Built-in illumination
- Video can be recorded and stored

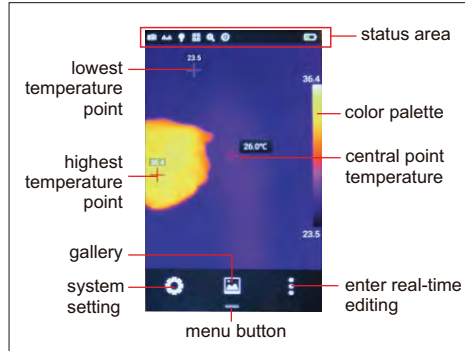

SPECIFICATION

IR resolution	192×144
NETD	≤50mk
Focus length	7mm/F1.1
Angle of view	37.8°×28.8°
Spatial resolution	3.45mrad
Focus adjustment	focus-free
Detector type	unrefrigerated vanadium oxide/8~14μm
Pixel size	25μm
Visible camera	resolution 500W, focus-free
Display	4" highlight LCD touch screen, 480×800
Image mode	IR image, visible image, MIF, PIP
Digital zoom	1.1~4
Color palette	8 modes
Temperature range	-20°C~350°C
Accuracy	±2°C or ±2% (of maximize range)
Emissivity	0.01-1.00 (adjustable)
Storage	in camera and TF card (up to 32GB)
Image format	JPG with temp info
Output	USB, HDMI
Power	rechargeable Li-ion battery (7.4V), working time≥4h
Operation temperature	-10°C~50°C
Vibration	10HZ~150HZ~10HZ 0.15mm (IEC 60068-2-6)
Impact	30g 11ms (IEC 60068-2-27)
Weight	735g
Dimension	274×97×78mm

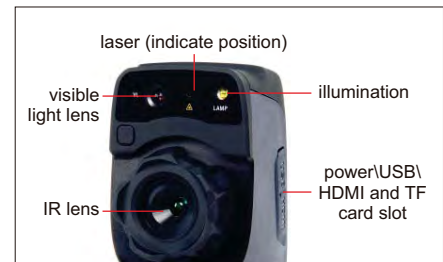

STANDARD DELIVERY

Main unit	1 pc
Power supply adapter	1 pc
USB cable	1 pc
HDMI cable	1 pc
Capacitive screen gloves	1 pc
TF card (16GB)	1 pc

INFRARED THERMOMETER (BASIC TYPE) CODE 0210-G260

SPECIFICATION

Measuring range	-30°C~260°C/-22°F~500°F
Accuracy	±4°C/±7°F (≤0°C) ±2% or ±2°C/±4°F (>0°C)
Resolution	0.1°C/0.1°F
Distance to spot size (D:S)	8:1
Emissivity	0.95 (fixed)
Diode laser	output<1mW, wavelength 630~670nm class 2 (II) laser product
Spectral response	6~14μm
Response time	less than 1s
Power supply	9V battery
Dimension	82×42×160mm
Weight	180g

- MAX/MIN temperature display
- °C/°F conversion function
- Auto data hold and auto power off

STANDARD DELIVERY

Main unit	1 pc
Battery	1 pc





- Unit: °C, °F
- Dual laser sighting
- Negativity display
- Automatic power off
- Automatic data hold
- Over range indicator
- Max/Min display

INFRARED THERMOMETER (STANDARD TYPE) CODE 0213-A500

STANDARD DELIVERY

Main unit	1 pc
Battery	1 pc

SPECIFICATION

Temperature range	-50°C~380°C/-58°F~716°F
Temperature accuracy	±2.5°C (at -50°C~20°C), ±2% or ±2.0°C (at 20°C~380°C) ±4.5°F (at -58°F~68°F), ±2% or ±3.6°F (at 68°F~716°F)
Temperature resolution	0.1°C/0.1°F
Distance to spot size (D:S)	12:1
Emissivity	0.95 (fixed)
Repeatability	±1°C/1.8°F
Response time	150ms
Spectral response	8~14µm
Diode laser	output<1mW, wavelength 630~670nm class 2 laser product
Operation temperature	0°C~50°C/32°F~122°F
Operation humidity	10%RH~90%RH
Storage temperature	-10°C~60°C/14°F~140°F
Storage humidity	<80%RH
Power supply	1×9V battery
Dimension	137×73×38mm
Weight	135g



- Ambient temperature, dew point temperature and humidity detection
- Unit: °C, °F
- Circular laser sighting
- Display backlight
- Automatic power off
- Automatic data hold
- Adjustable emissivity
- High and low alarm

INFRARED THERMOMETER (ADVANCED TYPE) CODE 0215-A900

STANDARD DELIVERY

Main unit	1 pc
Battery	1 pc

SPECIFICATION

Infrared sensor	temperature range	-50°C~800°C/-58°F~1472°F
	temperature resolution	0.1°C 0.1°F (-58°F~1000°F), other range 1°F
	temperature accuracy	±3.0°C (at -50°C~20°C) ±(1% of reading +1)°C (at 20°C~450°C) ±(2% of reading)°C (at 450°C~800°C)
	distance to spot size (D:S)	20:1
	emissivity	adjustable 0.10~1.00
	response time	<150ms
	spectral response	8~14µm
	diode laser	output<1mW, wavelength 630~670nm class 2 laser product
Temperature and humidity sensor	air temperature range	0°C~50°C/32°F~122°F
	dew point temperature range	0°C~50°C/32°F~122°F
	temperature resolution	0.1°C/0.1°F
	temperature accuracy	±1.0°C/±1.8°F
	humidity range	0%RH~100%RH
humidity resolution	±5%RH (20%RH~80%RH), other range ±7%RH	
Automatic power off	about in 10 seconds	
Power supply	1×9V battery	
Dimension	170×45×85mm	
Weight	196g	

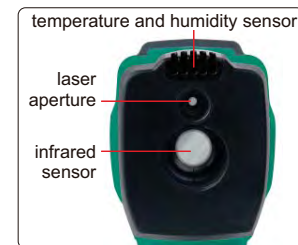

DATA LOGGER FOR TEMPERATURE AND HUMIDITY (BUILT-IN SENSOR) CODE 0311-3070

IP54
WATERPROOF

DATA
OUTPUT



stand (included)

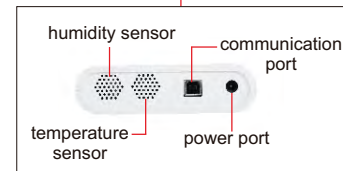

- Signal acquisition, display, storage, analysis function
- Low power consumption
- Built-in high-precision temperature and humidity sensor
- Software is included

SPECIFICATION

Temperature range	-30°C~70°C/-22°F~158°F
Temperature accuracy	±0.3°C (at 23°C±2°C), other range ±0.5°C ±0.6°F (at 73.4°F±3.6°F), other range ±0.9°F
Temperature resolution	0.1°C/0.2°F
Humidity range	0%RH~100%RH
Humidity accuracy	±3%RH (at 10%RH~85%RH), other range ±5%RH
Humidity resolution	0.1%RH
Memory capacity	10918
Alarm	function: alarm when over high or low limit method: display+buzz+backlight
Sampling interval	2s, 5s, 10s, 30s, 60s, 255s (adjustable)
Logging interval	2 seconds~24 hours (adjustable)
Start with delay	1~120 seconds (adjustable)
Start mode	start immediately/delay start/timing start
End mode	Full/FIFO/preset/timing end
Timing start/end	random start/end with format YYMMDD HHMMSS
Interface	USB
Time battery	CR2032
Power supply	3.6V lithium battery (ER14505) or 5~24V DC
Dimension	123×117×33mm
Weight	260g

STANDARD DELIVERY

Main unit	1 pc
Software and USB cable	1 pc
Power adapter	1 pc
Time battery	1 pc
Lithium battery	1 pc

software (included), record and download data to PC software via USB cable

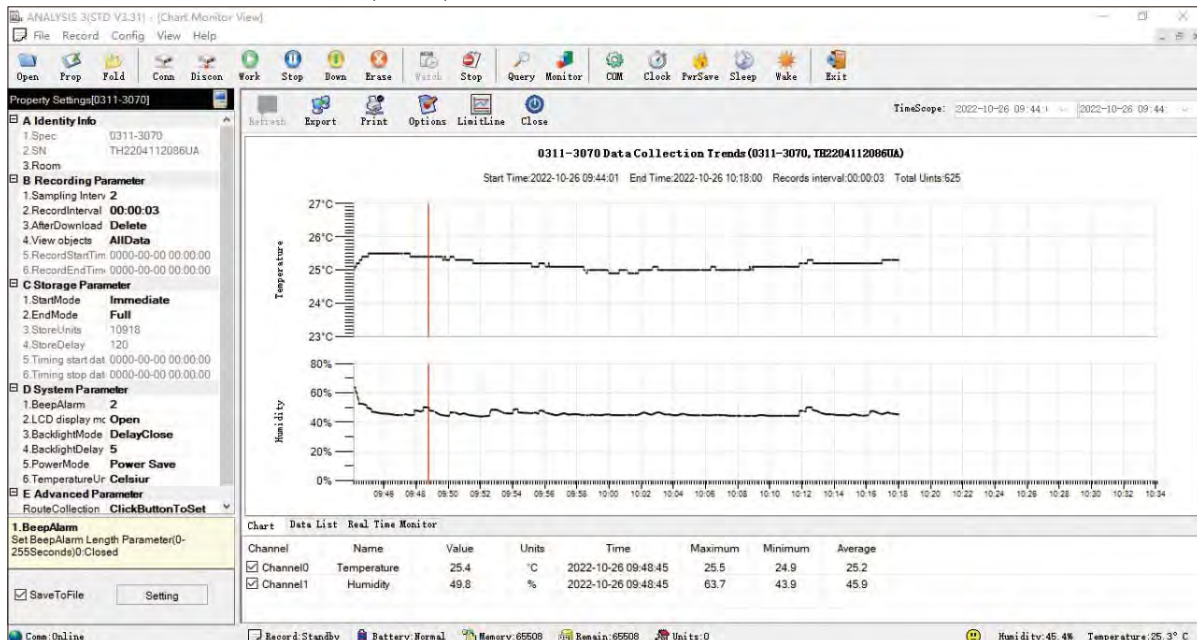



IP50
DUSTPROOF

DIGITAL THERMOHYGROMETER (PROFESSIONAL TYPE) CODE 9362-TH27

- Measure humidity, ambient temperature and dew-point temperature
- Max/Min/Average mode
- Alarm function
- IP50 protection grade



SPECIFICATION

Sensor model	NTC thermistor/humidity capacitance/digital sensor
Temperature range	-20°C~70°C/-4°F~158°F
Temperature accuracy	± 0.5°C/± 0.9°F
Temperature resolution	0.1°C/0.2°F (minimum adjustable unit is 0.2°F in setting mode)
Humidity range	0~100%RH
Humidity accuracy	±5%RH
Humidity resolution	0.1%RH
Sampling interval	5s
Battery	1.5V AAA
Dimension	95×107×18mm
Weight	105g

STANDARD DELIVERY

Main unit	1 pc
Battery (AAA)	1 pc

THERMOHYGROMETER (EXTERNAL SENSOR) CODE 0313-TH48

- External sensor, 3m cable
- Time/temperature/humidity display
- Temperature and humidity upper and lower limit alarm function
- Unit: °C/°F
- Low battery alarm



SPECIFICATION

Temperature range	-40°C~80°C/-40°F~176°F
Temperature accuracy	±0.5°C (at -20°C~60°C), ±1.0°C (at 60°C~80°C), ±2°C (at -40°C~-20°C), ±2°F(at -20°F~176°F), ±3°F (at -40°F~-20°F)
Temperature resolution	0.1°C (at -20°C~80°C), other range 1°C 0.1°F (at -20°F~100°F), other range 1°F
Humidity range	0%RH~99.9%RH
Humidity accuracy	±5%RH (at 10°C~60°C), other range ±7% ±5%RH (at 50°F~140°F), other range ±7%
Humidity resolution	0.1%RH
Sensitivity attenuation value	temperature: <0.1°C/year (<0.2°F/year) humidity: <1%RH/year
Sampling interval	5 seconds
Power supply	built-in rechargeable lithium battery (USB 5V charging) working time at least one month
Dimension	88×88×21mm
Weight	174g

STANDARD DELIVERY

Main unit	1 pc
USB charging cable	1 pc

K-TYPE THERMOCOUPLE THERMOMETER (ECONOMIC TYPE) CODE 0320-K230

- Contact K-type thermocouple
- Unit: °C/°F
- Data hold function
- Low battery display
- Display backlight

SPECIFICATION

Temperature range	-50°C~200°C/-58°F~392°F
Temperature accuracy	±2.0°C/±3.6°F
Temperature resolution	0.1°C (at -50°C~199.9°C), 1°C (at -50°C~200°C) 0.1°F (at -58°F~199.9°F), 1°F (at -58°F~392°F)
Sampling rate	2.5 times/sec
Power supply	3×3V CR2450 batteries (for 300 hours working)
Operation voltage	6.8V~10V
Dimension	149×76×34mm
Weight	220g

STANDARD DELIVERY

Main unit	1 pc
Thermocouple (K-type)	1 pc
CR2450 battery	3 pcs



THERMOHYGROMETER CODE 0310-H26

- Measure humidity, ambient temperature, dew point temperature and wet bulb temperature
- Min/Max, data hold function
- Bluetooth 4.0
- Auto power off
- Supplied with APP for Apple and Android

App measurement



App record

No.	Data Value (°C)	Data Value (%RH)
1	30.90	41.40
2	30.90	38.50
3	30.90	36.10
4	31.00	35.10
5	31.00	34.20
6	31.00	33.40
7	31.00	32.80
8	31.00	32.40
9	31.00	32.10
10	31.00	32.00
11	31.00	31.70
12	31.00	31.40



SPECIFICATION

Function	Measuring range	Resolution	Accuracy
Ambient temperature	0°C~50°C 32°F~122°F	0.1°C/0.1°F	±1.0°C/±1.8°F
Wet bulb temperature	0°C~50°C 32°F~122°F		
Dew point temperature	0°C~50°C 32°F~122°F		
Humidity	0%RH~80%RH	0.1%RH	±5.0%RH
Auto power off	30 minutes		
Data port	Bluetooth 4.0		
Power supply	9V battery		
Dimension	204×54×36mm		
Weight	172g		

STANDARD DELIVERY

Main unit	1 pc
Battery	1 pc

LARGE SCREEN TEMPERATURES AND HUMIDITY METERS



0314-H533A



0314-H533B

- High definition LED large screen display: temperature, humidity, time
- Exceeding limit alarm: buzzer alarm, digit/light flash alarm
- Installation method: wall mounted or ring type

SPECIFICATION

Code	0314-H323A	0314-H323B	0314-H423A	0314-H423B	0314-H533A	0314-H533B	0314-H643A	0314-H643B
Dimension	300×200×36mm		400×265×36mm		500×300×36mm		600×400×36mm	
Sensor type	integrated	separated	integrated	separated	integrated	separated	integrated	separated
Power consumption	5W		5W		9W		10W	
Weight	1.3kg		2kg		3kg		4kg	
Sensor	integrated: plastic probe case (not dustproof, not waterproof) separated: metal probe case (dustproof, waterproof), cable length 1m (can be customized, within 20m)							
Temperature range	integrated: -20°C~60°C separated: -40°C~85°C							
Temperature resolution	integrated: 0.1°C (at 0°C~60°C), other range 1°C separated: 0.1°C (at 0°C~85°C), other range 1°C							
Temperature accuracy	integrated: ±0.5°C (at 0°C~60°C), other range ±2°C separated: ±0.5°C (at 0°C~85°C), other range ±2°C							
Humidity range	5%RH~95%RH							
Humidity resolution	0.1%RH							
Humidity accuracy	±3%RH (@25°C)							
Long-term stability	temperature≤0.1°C/year humidity≤1%RH/year							
Repeatability	temperature≤0.1°C humidity≤0.5%RH							
Sampling speed	1s							
Response time	3 minutes to reach 90% of the final value							
Time accuracy	±15s/month (@25°C±2°C)							
Power supply	AC100~240V (50/60Hz)							
Power cable length	1m (can be customized, 2m/5m)							
Operation condition	temperature: -20°C~60°C humidity: 5%~95% (non-condensing)							

STANDARD DELIVERY

Main unit (including sensor)	1 pc
------------------------------	------

THERMOHYGROMETER (ECONOMIC TYPE) CODE 0312-TH50

- Environment comfort display: COMFORT, WET, DRY
- Time/temperature/humidity display
- Highest/lowest temperature and humidity memory function
- Alarm clock function
- Unit: °C, °F

SPECIFICATION

Temperature range	0°C~50°C/32°F~122°F
Temperature accuracy	±1.0°C (at 5°C~40°C), other range ±1.5°C ±1.8°F (at 41°F~104°F), other range ±2.7°F
Temperature resolution	0.1°C/0.1°F
Humidity range	10%RH~90%RH
Humidity accuracy	±5%RH (at 40%RH~80%RH), other range ±8%RH
Humidity resolution	1%RH
Power supply	1×AAA 1.5V battery
Dimension	108×60×15mm
Weight	74g



STANDARD DELIVERY

Main unit	1 pc
Battery	1 pc

PORTABLE MEDIUM TEMPERATURE DRY BLOCK CALIBRATOR CODE DBC-M660

real-time display of curve

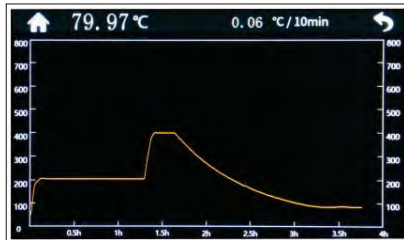

- Used for temperature calibration in industrial or laboratory
- Unit: °C, °F
- Language: English, Chinese
- Overheat protection
- Multi-point temperature correction function
- Automatic tuning of temperature control parameters
- Segmented PID control, one-button heating, full-automatic temperature control



soaking block (included),
can be customized

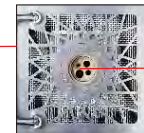

soaking block

SPECIFICATION

Temperature range	50°C~660°C	
Horizontal temperature field	≤0.2°C	
Vertical temperature field	within 40mm from the bottom of the well	≤0.5°C (at 50°C~300°C)
		≤1.0°C (at 300°C~660°C)
Temperature fluctuation	±0.15°C	
Temperature resolution	0.01°C	
Control method	touch screen	
Soaking block	insertion aperture: Ø4.5mm, Ø6.5mm, Ø8mm, Ø10mm (can be customized)	
Well depth	170mm	
Power	600W	
Power supply	220V/50Hz	
Dimension	285×170×335mm	
Weight	9.4kg	



STANDARD DELIVERY

Main unit	1 pc
Soaking block	1 pc



Roundness/Cylindricity Testers
Page 670-671



Roundness Measuring Machines
Page 672-673



Precision Air Floating Rotary Tables
Page 674



Surface Profile Measuring Machines
Page 675-680



Roughness Testers
Page 677-693



Surface Roughness Specimens
Page 693-694



**Surface Roughness Reference
Specimens**
Page 695

ROUNDNESS/CYLINDRICITY TESTER CODE RCT-300



- Automatic centering and leveling
- Evaluation items
 - Cylindricity module: cylindricity, radial full run, coaxiality, taper, radius
 - Roundness module: roundness, concentricity, radial single jump, wall thickness difference
 - Straightness module: straightness, parallelism, squareness
 - Single section flatness module: single section flatness, axial single hop, perpendicularity, parallelism
 - Multi-section flatness module: multi-section flatness, parallelism, axial full runout, perpendicularity
 - Commutator module: monolithic bounce, immediate bounce, interval difference
- Analytical ability
 - Cylindricity function: 2-10 sections, 3 evaluation methods
 - Reference benchmarks for cylindricity evaluation: LSCY, MZCY, MICY, MCCY, OSCY
 - Reference circle for roundness evaluation: LSC, MZC, MIC, MCC
 - Measurement band: 1-15upr, 1-50upr, 1-150upr, 1-250upr, 1-500upr, 15-100upr, 15-500upr, 2-15upr, 1-1500upr, custom
 - Notched measurement



SPECIFICATION

Probe	measuring range	±500µm
	resolution	1:262144
	linear accuracy	0.1%
Ruby stylus	size	Ø2x10mm
	direction	two directions
	adjustable angle	±45°
X axis	travel	165mm
	excess range	25mm
	drive mode	motor
	moving speed	0.1~50mm/s
Z axis	measuring range	480mm
	straightness	0.3µm/100mm
	movement speed	0.1~10mm/s
	movement mode	motor
Detector	acquisition device	circular grating
	circumferential sampling points	14400
Granite stage		900×500mm
Rotary stage	rotation accuracy	(0.025+6H/10000)µm, H is the measuring height in mm
	rotation speed	6rpm, 8rpm, 10rpm
	max. measuring diameter	300mm
	max. workpiece diameter (rotation diameter)	450mm
Automatic adjustment stage	workbench diameter	280mm
	adjustment range of center	±3mm
	adjustment range of level	±1°
	weight capacity	30kg
Precision chuck	external grip diameter	Ø1~Ø81mm
	internal grip diameter	Ø31~Ø70mm
Air filter	pressure range	0~0.8MPa
	oil mist removal accuracy	0.01µm
	export oil mist concentration	0.5mg/m³
Dimension (LxWxH)		1680×862×1685mm
Power supply		220±10%V, 50Hz
Power		500W
Weight		350kg

To be continued

Continued from previous page



air filter (included)



standard block (included)



column adjusting rod (included)



precision chuck (included)

STANDARD DELIVERY

Main unit	1 pc
Probe (with ruby stylus)	1 pc each
Standard block	1 pc
Column adjusting rod	1 set
Precision chuck	1 pc
Automatic adjustment stage	1 pc
Roundness cylindricity acquisition and analysis system	1 set
Air filter	1 set
Computer	1 pc
Printer	1 pc
Installation tools	1 set

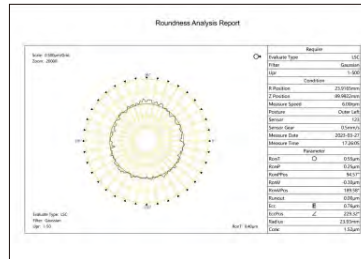

roundness analysis

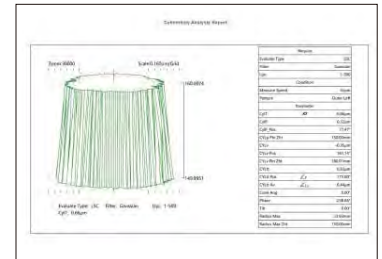

cylindricity analysis

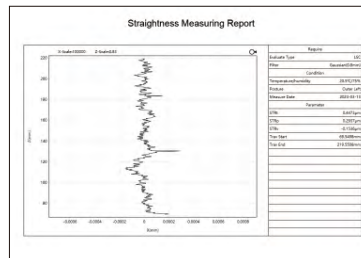

straightness analysis

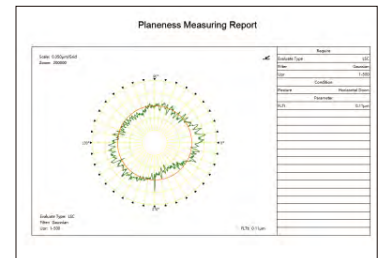

planeness analysis

OPTIONAL ACCESSORY

Probes	see below details
Precision chucks	see below details
Dryer	ISC-DRY

SPECIFICATION OF PROBES

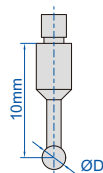

Code	Diameter (ØD)	Remark
RCT-RA260-T1	2mm	included
RCT-RA260-T2	0.5mm	optional
RCT-RA260-T3	1mm	optional
RCT-RA260-T4	4mm	optional
RCT-RA260-T5	8mm	optional

SPECIFICATION OF PRECISION CHUCKS

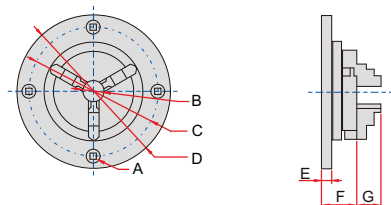

Code	A	B	C	D	E	F	G	Clamping range		Remark
								external grip dia.	internal grip dia.	
RCT-RA260-C1	M5x0.8	16	100	118	8	28	13	Ø0.8~63	Ø23~58	optional
RCT-RA260-C2	M6x1.0	20	116	143	10.5	37	15	Ø1~81	Ø31~70	included
RCT-RA260-C3	M6x1.0	26	140	168	10	39	19	Ø1~100	Ø36~90	optional

ROUNDNESS MEASURING MACHINE CODE RCT-RA260



- Air-floating spindle
- Can measure roundness, coaxiality, concentricity, flatness, radial runout, axial runout, parallelism and perpendicularity.
- Spectrum analysis, automatic gap/burr removal, waveform analysis
- 4 roundness evaluation methods: smallest area method, least square method, smallest circumscribed circle method, largest inscribed circle method
- Measuring filer: 1-15 μ r, 1-50 μ r, 1-150 μ r, 1-250 μ r, 1-500 μ r, 15-100 μ r, 15-500 μ r, 2-15 μ r
- Filter form: gauss (ISO standard)
- Software is included, for measurement, analysis, data output, etc.



SPECIFICATION

Probe	measuring range	$\pm 300\mu\text{m}$
	resolution	$0.001\mu\text{m}$
	linear accuracy	0.25%
Ruby stylus	size	$\varnothing 2 \times 10\text{mm}$
	direction	two directions
	adjustable angle	$\pm 45^\circ$
X axis	travel	165mm
	excess range	25mm
	drive mode	by hand
Z axis	drive mode	motor
	travel	320mm
	movement speed	0.5~10mm/s
Rotary stage	rotation accuracy	$(0.025+6H/10000)\mu\text{m}$ for $H \leq 20\text{mm}$, H is the measuring height in mm
	rotation speed	6rpm
	max. measuring diameter	260mm
	max. workpiece diameter (rotation diameter)	400mm
Rotary axis	radial rotation accuracy	$\pm 0.0125\mu\text{m}$
	axial runout accuracy	$\pm 0.05\mu\text{m}$
	diameter	180mm
Adjustable 3D stage	adjustment range of center	$\pm 3\text{mm}$
	adjustment range of level	$\pm 2^\circ$
	weight capacity	20kg
	Granite stage	700 \times 500mm
Precision chuck	external grip diameter	$\varnothing 1 \sim \varnothing 81\text{mm}$
	internal grip diameter	$\varnothing 31 \sim \varnothing 70\text{mm}$
Air filter	pressure range	0~0.8MPa
	oil mist removal accuracy	$0.01\mu\text{m}$
	export oil mist concentration	$0.5\text{mg}/\text{m}^3$
Dimension (LxWxH)	1300 \times 795 \times 1715mm	
Power supply	220 $\pm 10\%$ V, 50Hz	
Power	500W	
Weight	320kg	

To be continued

Continued from previous page

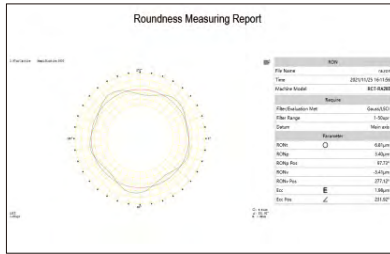

measurement

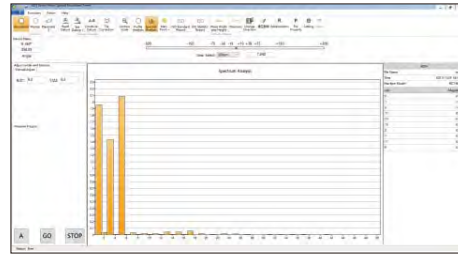

STANDARD DELIVERY

Main unit	1 pc
Probe (with ruby stylus)	1 pc each
Standard block	1 pc
Precision chuck	1 pc
Adjustable 3D stage	1 pc
Rotary stage	1 pc
Computer	1 pc
Software	1 set
Printer	1 pc
Air filter	1 set
Installation tools	1 set



standard block (included)

OPTIONAL ACCESSORY

Probes	refer to details
Precision chucks	refer to details
Dryer	ISC-DRY

SPECIFICATION OF PROBES

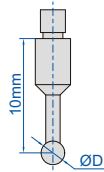

Code	Diameter (ØD)	Remark
RCT-RA260-T1	2mm	included
RCT-RA260-T2	0.5mm	optional
RCT-RA260-T3	1mm	optional
RCT-RA260-T4	4mm	optional
RCT-RA260-T5	8mm	optional

SPECIFICATION OF PRECISION CHUCKS

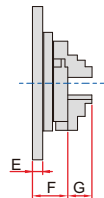
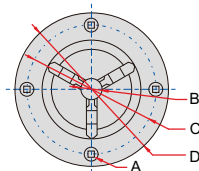

Code	A	B	C	D	E	F	G	Clamping range		Remark
								external grip dia.	internal grip dia.	
RCT-RA260-C1	M5x0.8	16	100	118	8	28	13	Ø0.8~63	Ø23~58	optional
RCT-RA260-C2	M6x1.0	20	116	143	10.5	37	15	Ø1~81	Ø31~70	included
RCT-RA260-C3	M6x1.0	26	140	168	10	39	19	Ø1~100	Ø36~90	optional

(mm)

PRECISION AIR FLOATING ROTARY TABLES



6875-320

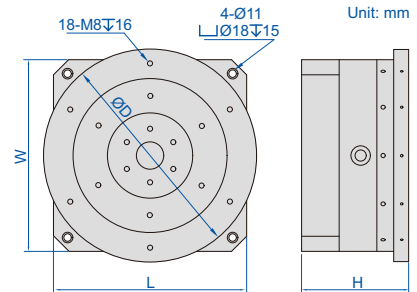

- Manual rotation
- Optional accessory:
high precision digital indicators (code 2133 series),
hydraulic universal magnetic stands (code 6274 series)

air filter (included)



Code	Stage size ØD	Max. RPM	Air supply pressure	Max. load	Radial stiffness	Axial stiffness	Radial runout	Axial runout	L×W×H
6875-320	320mm	500rpm	5-6bar	100kg	250N/μm	500N/μm	<0.3μm	<0.3μm	272x272x161mm
6875-400	400mm	500rpm	5-6bar	100kg	250N/μm	500N/μm	<0.3μm	<0.3μm	272x272x161mm
6875-500	500mm	500rpm	5-6bar	100kg	250N/μm	500N/μm	<0.3μm	<0.3μm	272x272x191mm

Standard glass hemisphere (optional)

Code	Roundness
6875-BALL*	0.05μm

*To check the accuracy of rotary table



6875-BALL



6875-CLAMP

Clamp for glass hemisphere (optional)

Code
6875-CLAMP

application



SURFACE PROFILE MEASURING MACHINE CODE SPM-1000

- Software is included, for surface profile measurement and data output
- Probe compensation
- Output as format txt, csv, etc.
- Large range design, the leverage ratio is 1:2.2, maintain the original accuracy of the sensor
- The overall structure of the Z-axis sensor does not have any elastic components, ensuring the measuring force is constant regardless the position of probe

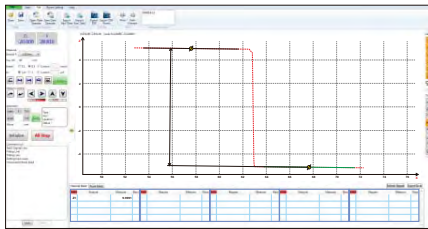
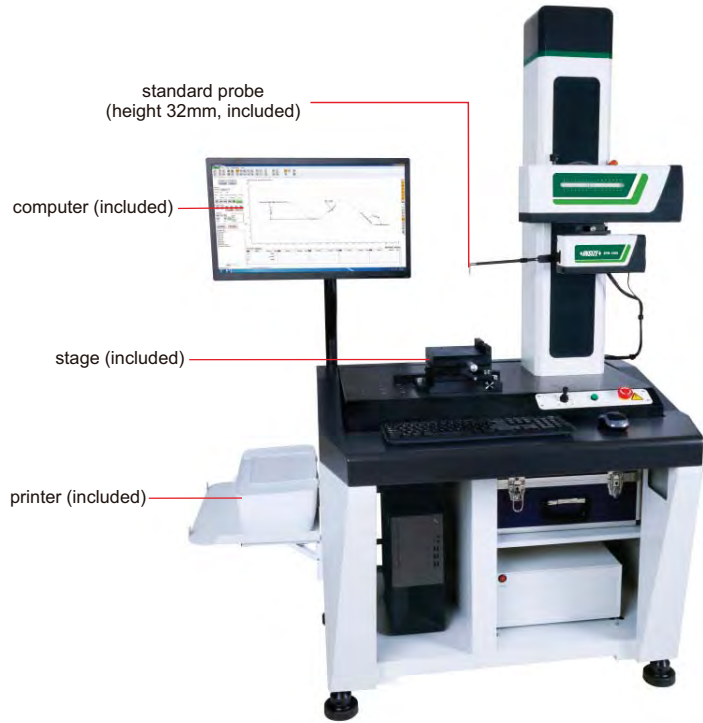

calibration

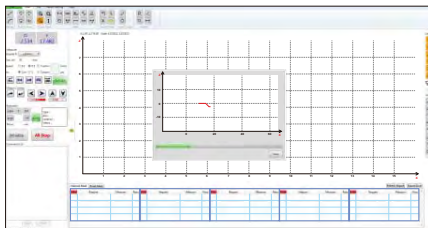

contour scanning

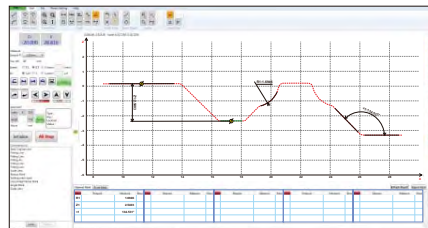

dimension measurement

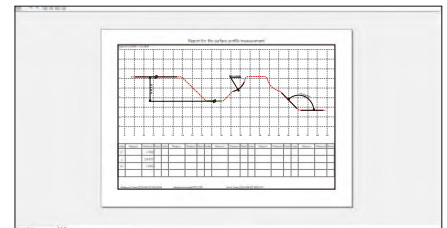

data output

SPECIFICATION

X axis measuring range	140mm
X axis resolution	0.2 μ m
X axis straightness	0.8 μ m/100mm
X axis moving speed	0.1~10mm/s
Z axis measuring range	\pm 20mm
Z axis resolution	0.05 μ m
Z axis moving speed	0.5~10mm/s
Linear accuracy	$\pm(1.5+ 0.2H)\mu$ m, H is measuring height in mm
Angular measuring accuracy	$\pm 2'$
Arc measuring accuracy	$\pm(2+R/8)\mu$ m, R is 2~10mm standard ball
Radius of probe tip	25 μ m
Moving direction	backward
Measuring force	6.86~9.8mN
Measuring unit	mm/inch
Traceable angle	72° (upward), 87° (downward)
Drive mode	motor
Travel of Z axis	430mm
Dimension (L*W*H)	1200*700*1780mm
Power supply	220 \pm 5%V, 50Hz
Weight	320kg

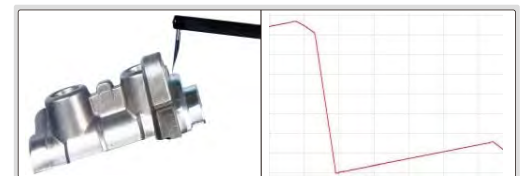

standard balls (included)



standard blocks (included)



standard shaft (included)

To be continued

Continued from previous page

STANDARD DELIVERY

Main unit	1 pc
Standard probe and arm	1 pc of each
Standard block	2 pcs
Standard ball	2 pcs
Standard shaft	1 pc
Stage	1 pc
Vise	1 pc
Measuring arm	1 pc
Computer	1 pc
Measurement software	1 pc
Printer	1 pc
Installation tools	1 set

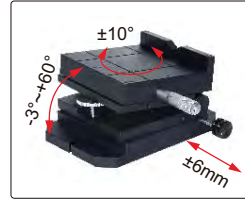

stage (included)



vise (included)

OPTIONAL ACCESSORY

Probe	refer to details
-------	------------------

SPECIFICATION OF PROFILE PROBES

Unit: mm

<p>chisel stylus</p> <p>code SPM-1000-T01 (H=32mm, included) code SPM-1000-T02 (H=48mm, optional) code SPM-1000-T03 (H=68mm, optional)</p>	<p>cone stylus</p> <p>code SPM-1000-Z01 (H=32mm, optional) code SPM-1000-Z02 (H=48mm, optional) code SPM-1000-Z03 (H=68mm, optional)</p>	<p>ball stylus</p> <p>code SPM-1000-R01 (H=32mm, optional) code SPM-1000-R02 (H=48mm, optional) code SPM-1000-R03 (H=68mm, optional)</p>
<p>standard arm, code SPM-1000-SP (included), stylus is not included</p>		<p>probe for small holes, code SPM-1000-SBP (optional), stylus is included</p> <p>measure the contour of holes with diameter > Ø8mm</p>
<p>transverse probe, code SPM-1000-LP (optional), stylus is included</p> <p>measure the contour of holes in radial direction</p>		



ROUGHNESS AND PROFILE MEASURING MACHINE CODE SPM-2000

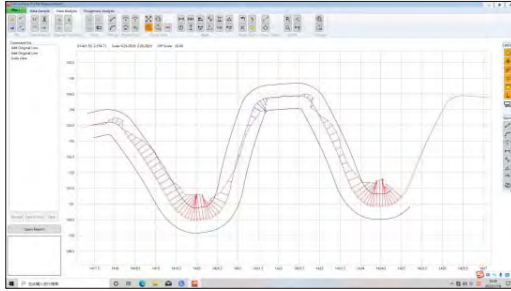

CAD profile comparison

- Software is included, for measurement and data output
- Profile sensor with low noise
- Wide range roughness sensor without skid
- Meet ISO1997, ISO1984, BS1988, DIN1990, ASME1995, JIS1982, JIS1994 standards
- 65 roughness parameters

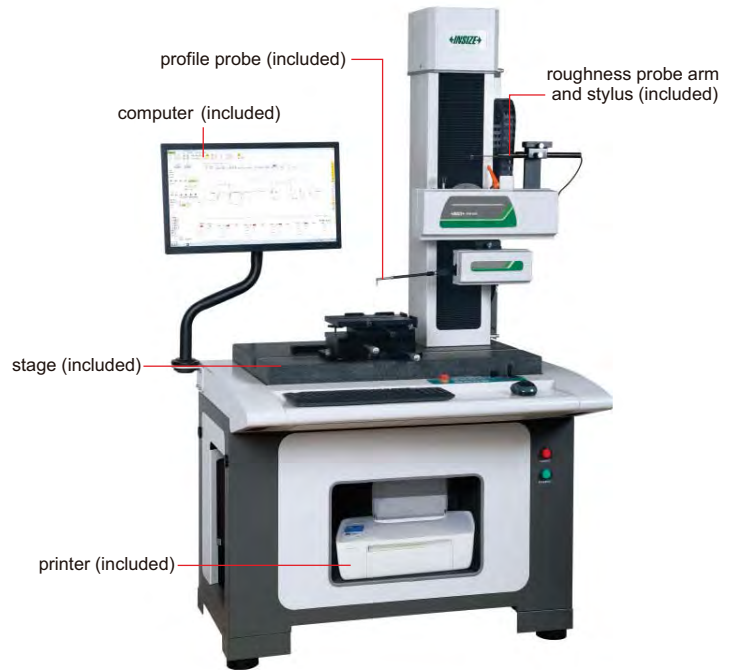

PROFILE MEASUREMENT SPECIFICATION

X axis measuring range	140mm
X axis resolution	0.2µm
X axis traverse speed	0.05~15mm/s
Z axis measuring range	50mm
Z axis resolution	0.05µm
Z axis traverse speed	0.2~15mm/s
Straightness	0.5µm/100mm
Linear accuracy	±(0.8+ 0.15H)µm, H is measuring height in mm
Angular measuring accuracy	±1'
Arc measuring accuracy	±(1.5+R/12)µm, R is 2~10mm standard ball
Measuring unit	µm/µin
Measuring speed	0.05~1mm/s
Traceable angle	72° (upward), 88° (downward)
Travel of Z axis	430mm
Power supply	220±5%V, 50Hz
Dimension (L×W×H)	1400×850×1780mm
Weight	350kg

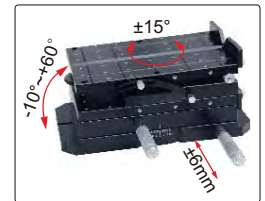

stage (included)



vise (included)



standard shaft (included)



standard blocks (included)



standard balls (included)

ROUGHNESS MEASUREMENT SPECIFICATION

Roughness parameters	Ra, Rp, Rv, Rz, Rz (JIS), R3z, Rz (DIN), Rzj, Rmax, Rc, Rt, Rq, Rsk, Rku, Rsm, Rs, PΔq, Rk, Rpk, Rvk, Mr1, Mr2, Rmr
Waviness parameters	Wa, Wt, Wp, Wv, Wz, Wq, Wsm, Wsk, Wku, Wmr
Primary profile parameters	Pa, Pt, Pp, Pv, Pz, Pq, Psm, Psk, Pku, Pmr
Measuring range	±420µm
Resolution	0.001µm
Linear accuracy	±(5nm+2.8%)
Probe radius/angle	5µm/90°
Cut off	0.025/0.08/0.25/0.8/2.5/8mm
Number of cut-offs	2~7
Measuring unit	µm
Measuring speed	0.05~0.25mm/s

To be continued

Continued from previous page

STANDARD DELIVERY

Main unit	1 pc
Calibration block	1 set
Roughness probe arm	1 pc
Roughness stylus	1 pc
Profile probe arm	1 pc
Profile chisel stylus	1 pc
Stage	1 set
Vise	1 set
Computer	1 pc
Software	1 set
Printer	1 pc
Installation tools	1 set

OPTIONAL ACCESSORY

Probe	refer to details
-------	------------------

SPECIFICATION OF ROUGHNESS PROBE

standard probe, code SPM-2000-P (included), stylus is included

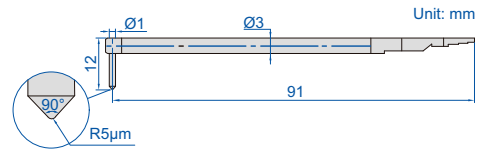

small roughness probe, code SPM-2000-P1 (optional), stylus is included

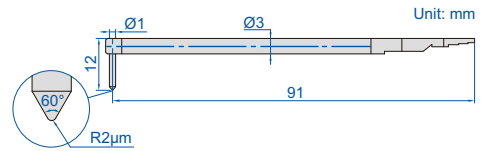

SPECIFICATION OF PROFILE PROBES

Unit: mm

chisel stylus

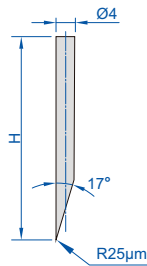

code SPM-1000-T01 (H=32mm, included)
code SPM-1000-T02 (H=48mm, optional)
code SPM-1000-T03 (H=68mm, optional)

cone stylus

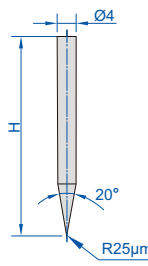

code SPM-1000-Z01 (H=32mm, optional)
code SPM-1000-Z02 (H=48mm, optional)
code SPM-1000-Z03 (H=68mm, optional)

ball stylus

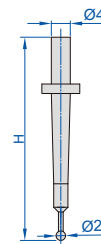

code SPM-1000-R01 (H=32mm, optional)
code SPM-1000-R02 (H=48mm, optional)
code SPM-1000-R03 (H=68mm, optional)

standard arm, code SPM-1000-SP (included), stylus is not included

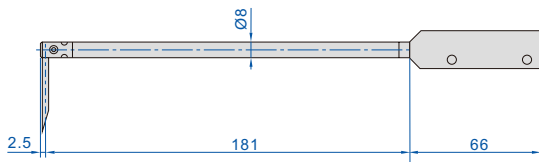

probe for small holes, code SPM-1000-SBP (optional), stylus is included

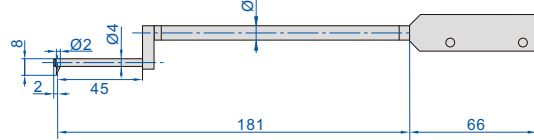

measure the contour of holes with diameter > Ø8mm

transverse probe, code SPM-1000-LP (optional), stylus is included

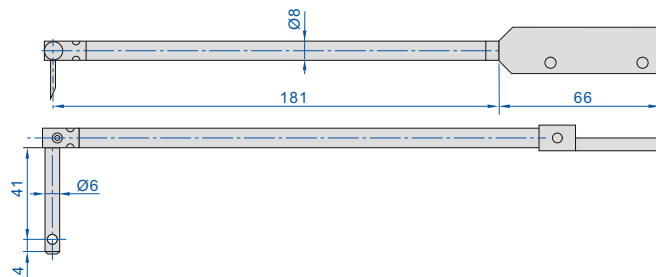

measure the contour of holes in radial direction

ROUGHNESS AND PROFILE MEASURING MACHINE (ONE PROBE TYPE) CODE SPM-5000



- Roughness, waviness, and profile analysis can be achieved with just one measurement
- Can measure all roughness and waviness parameters
- Can be used for automatic measurement system
- Air flotation and shockproof system to reduce measurement deviation
- Free to edit measurement reports

PROFILE MEASUREMENT SPECIFICATION

X axis measuring range	100mm
X axis resolution	0.2μm
X axis traverse speed	0.05~50mm/s
X axis linear accuracy	$\pm(0.8+ 0.015L)\mu\text{m}$, H is measuring length in mm
Z axis measuring range	$\pm 10\text{mm}$
Z axis resolution	0.01μm
Z axis traverse speed	0.2~50mm/s
Z axis linear accuracy	$\pm(0.5+ 0.08H)\mu\text{m}$, H is measuring height in mm
Angular measuring accuracy	$\pm 1'$
Arc measuring accuracy	$\pm(1+R/12)\mu\text{m}$, R is 2~10mm standard ball
Straightness	0.3μm/100mm,
Measuring unit	mm/inch
Travel of Z axis	320mm
Power supply	220±5%V, 50Hz
Dimension (L×W×H)	1700×820×1900mm
Weight	500kg

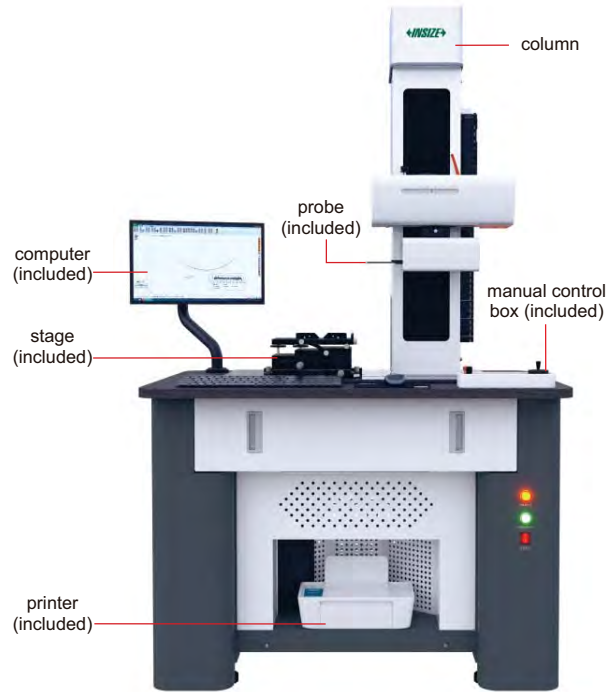

standard balls (included)



standard shaft (included)

ROUGHNESS MEASUREMENT SPECIFICATION

Roughness parameters	Ra, Ramax, Ramin, Rasd, Rp, Rpmax, Rpmin, Rpsd, Rv, Rvmax, Rvmin, Rvsd, Rz, Rzmax, Rzmin, Rzsd, R3z, Rc, Rcmx, Rcmn, Rcsd, Rt, Rq, Rqmax, Rqmin, Rdsd, Rsk, Rskmax, Rskmin, Rsksd, Rku, Rkumax, Rkumin, Rkugd, Rsm, Rsmmax, Rsmmin, Rmsd, Rs, RΔa, RΔamax, RΔamin, RΔasd, RΔq, RΔqmax, RΔqmin, RΔqsd, Rk, Rpk, Rvk, Mr1, Mr2, Rλα, Rλamax, Rλamin, Rλasd, Rλq, Rλqmax, Rλqmin, Rλqsd, Rδc, Rpc, Rmr
Waviness parameters	Wa, Wamax, Wamin, Wasd, Wsa, Wca, Wa08, Wc, Wcmax, Wcmin, Wcsd, Wt, Wz, Wzmax, Wzmin, Wzsd, Wp, Wpmax, Wv, Wvmax, Wvmin, Wvsd, Wq, Wqmax, Wqmin, Wqsd, Wsm, Wsmmax, Wsmmin, Wmsd, Wsk, Wskmax, Wskmin, Wksd, Wku, Wkumax, Wkumin, Wkugd, WΔq, WΔqmax, WΔqmin, WΔqsd, Wδc, Wmr, Wpsd, Wpmin
Original profile parameters	Pa, Pt, Pp, Pc, Pv, Pz, Pq, Psm, Psk, Pku, RzJ, Rpq, Rvq, Rmq, Pmr, PΔq, Avh, Hmax, Hmin, Area, Pδc, Tilta
Motif parameters	Ncrx, R, Rx, AR, Nr, Cpm, Sr, Sar, W, Wx, Aw, Wte, Nw, Sw, Saw
Measuring range	$\pm 10\text{mm}$
Resolution	0.01μm
Linear accuracy	$\leq \pm(4\text{nm}+2.5\%)$
Probe radius/angle	5μm/90°
Cut off	0.025/0.08/0.25/0.8/2.5/8mm
Number of cut-offs	2~7
Measuring unit	μm
Measuring speed	0.1~2mm/s

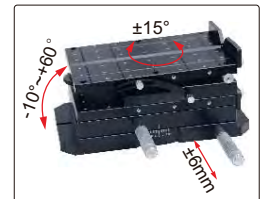

stage (included)



vise (included)



standard blocks (included)

To be continued

Continued from previous page

STANDARD DELIVERY

Main unit (including workbench, controller, driver, sensor)	1 pc
Calibration block	1 set
Probe arm	1 pc
Stylus	1 pc
Air flotation and shockproof system	1 set
Stage	1 set
Vise	1 set
Computer	1 pc
Software	1 set
Printer	1 pc
Installation tools	1 set

SPECIFICATION OF STANDARD PROBE

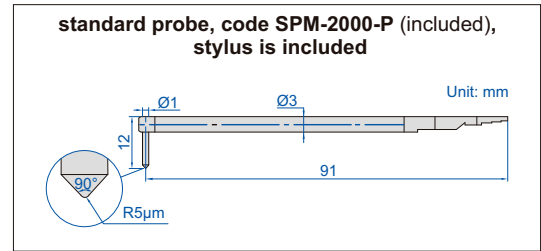

OPTIONAL ACCESSORY

Probe	refer to details
-------	------------------

SPECIFICATION OF PROFILE PROBES

Unit: mm

<p>chisel stylus</p> <p>code SPM-1000-T01 (H=32mm, optional) code SPM-1000-T02 (H=48mm, optional) code SPM-1000-T03 (H=68mm, optional)</p>	<p>cone stylus</p> <p>code SPM-1000-Z01 (H=32mm, optional) code SPM-1000-Z02 (H=48mm, optional) code SPM-1000-Z03 (H=68mm, optional)</p>	<p>ball stylus</p> <p>code SPM-1000-R01 (H=32mm, optional) code SPM-1000-R02 (H=48mm, optional) code SPM-1000-R03 (H=68mm, optional)</p>
<p>standard arm, code SPM-1000-SP (optional), stylus is not included</p>	<p>probe for small holes, code SPM-1000-SBP (optional), stylus is included</p> <p>measure the contour of holes with diameter > Ø8mm</p>	
<p>transverse probe, code SPM-1000-LP (optional), stylus is included</p> <p>measure the contour of holes in radial direction</p>		

ROUGHNESS MEASURING MACHINE CODE SPM-4000

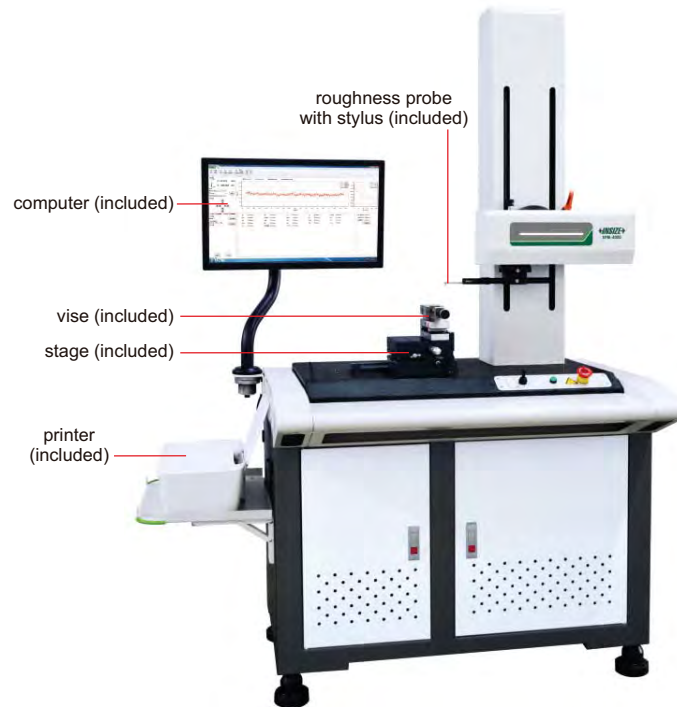

- Skidless probe
- Hundreds of parameters can be evaluated, such as roughness profile, waviness profile, primary profile, etc.
- Software is included, for measurement and data output

SPECIFICATION

Roughness parameters	Ra, Rp, Rv, Rz, Rz (JIS), R3z, Rz (DIN), Rzj, Rmax, Rc, Rt, Rq, Rsk, Rku, Rsm, Rs, RΔq, Rk, Rpk, Rvk, Mr1, Mr2, Rmr
Waviness parameters	Wa, Wt, Wp, Wv, Wz, Wq, Wsm, Wsk, Wku, Wmr
Primary profile parameters	Pa, Pt, Pp, Pv, Pz, Pq, Psm, Psk, Pku, Pmr
X axis measuring range	100mm
X axis resolution	0.2μm
X axis straightness	0.5μm/100mm
X axis moving speed	0.1~10mm/s
Z axis measuring range	±420μm
Z axis resolution	0.001μm
Z axis linear accuracy	±(7nm+3.5%)
Z axis moving speed	0.5~10mm/s
Z axis repeatability	1δ≤2nm
Radius/angle of stylus	5μm/90°
Cut off length	0.025/0.08/0.25/0.8/2.5/8mm
Number of cut-offs	2~7
Measuring unit	μm
Drive mode	motor
Travel of Z axis	320mm
Dimension (LxWxH)	1200×700×1780mm
Power supply	220±5%V, 50Hz
Weight	320kg

To be continued

Continued from previous page

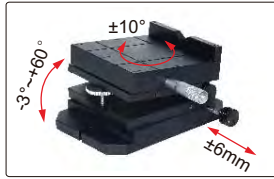

stage (included)



vise (included)



calibration block (included)

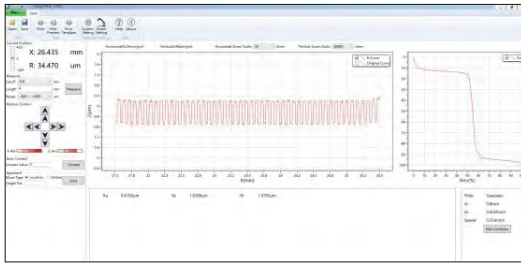

calibration

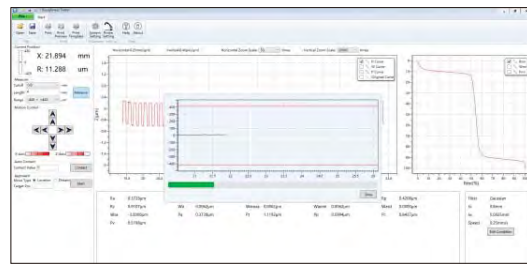

measurement

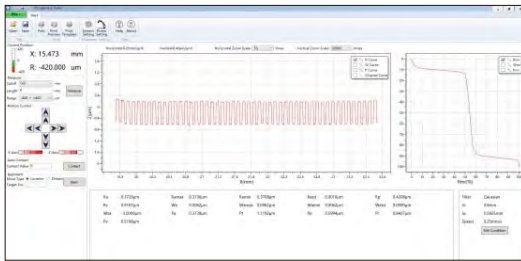

parameter measurement

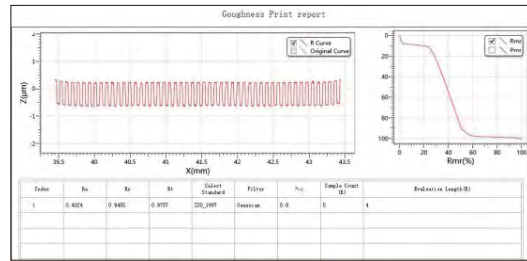

data output

STANDARD DELIVERY

Main unit	1 pc
Roughness probe (with stylus)	1 pc
Calibration block	1 pc
Stage	1 pc
Vise	1 pc
Computer	1 pc
Software	1 set
Printer	1 pc
Installation tools	1 set

OPTIONAL ACCESSORY

Small roughness probe	refer to details
-----------------------	------------------

SPECIFICATION OF ROUGHNESS PROBE

Unit: mm

standard probe, code SPM-4000-P (included)

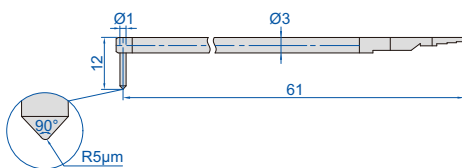

small roughness probe, code SPM-4000-P1 (optional)

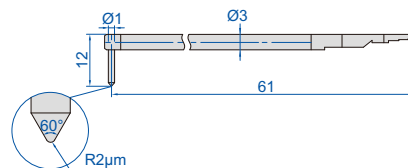

- BLUETOOTH
- DATA OUTPUT
- PROBE CAN BE CHANGED

ROUGHNESS TESTER (COMPACT TYPE) CODE ISR-C200

INSIZE PLUS
MADE IN EUROPE

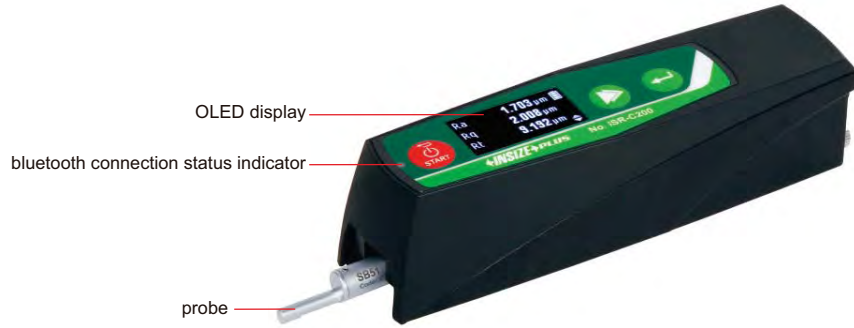

- The product is light, reliable and durable
- 13 roughness parameters
- Can be operated by mobile phones (only Android system) or computers
- Measurement results can be exported in Excel and PDF format
- Memory of 18000 measurements with only parameters or 30 measurements with graph
- Automatic power off



probe can be set at 90°, for transverse measurement



probe cover (included)

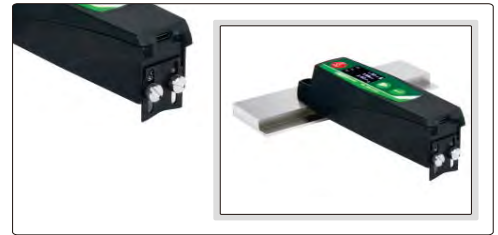

adjustable stand (included)

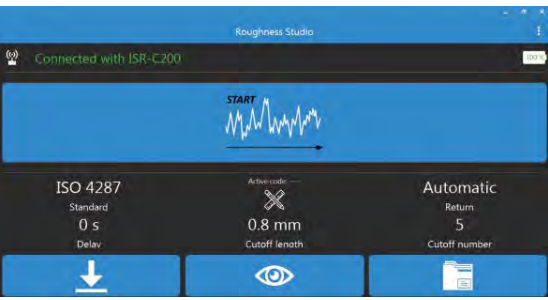
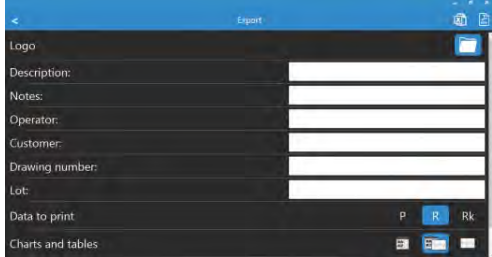

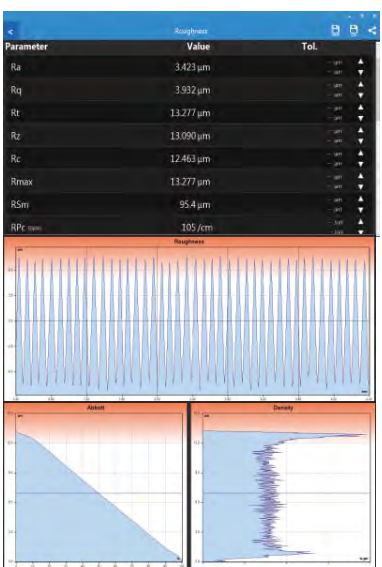
measuring software (included), connect to mobile phones via bluetooth (only Android system) to control roughness tester, or connect to computers via USB cable or bluetooth to control roughness tester, display roughness values and curve, results can be exported in Excel and PDF format

To be continued

Continued from previous page

magnetic stand adapter (included)



dial test indicator holder (optional)

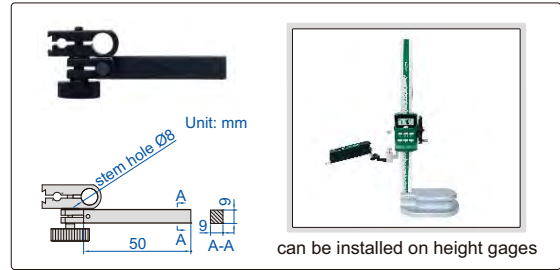

SPECIFICATION

Parameters		Ra, Rq, Rt, Rz, Rc, Rmax, RSm, Rpc, Pt, R, AR, Rx, Ppc
Range	X axis	17.5mm
	Z axis	250µm
Accuracy		±(5%+0.025)µm
Resolution (Ra)		0.001µm
Probe	type	inductive
	stylus radius/angle	2µm/90°
	stylus material	diamond
Measuring unit		µm/µin
Cut off		0.25/0.8/2.5mm
Number of cut-off		1~5
Moving speed		0.5mm/s, 1mm/s
Memory		18000 measurements with only parameters, 30 measurements with graph
Power		built-in rechargeable battery
Dimension (L×W×H)		160×34×33.5mm
Weight		200g

STANDARD DELIVERY

Main unit	1 pc
Standard probe	1 pc
Calibration block	1 pc
Adjustable stand	1 pc
Probe cover	1 pc
Magnetic stand adapter	1 pc
Software and USB cable	1 pc
AC/DC adapter	1 pc

OPTIONAL ACCESSORY

Dial test indicator holder	6293-6
Groove probe	ISR-C200-SB21
Small hole probe	ISR-C200-SB31
Deep groove probe	ISR-C200-SB121
Extension rod	ISR-C200-ER50
Extension rod	ISR-C200-ER100

SPECIFICATION OF PROBES

Unit: mm

<p>standard probe (included)</p> <p>transverse measurement</p> <p>transverse measurement</p> <p>measurement for plane surfaces, also transverse measurement for plane surfaces, cylinders and grooves</p>	<p>groove probe (optional), code ISR-C200-SB21</p> <p>width>4</p> <p>depth≤5</p> <p>measure plane surfaces and grooves</p>
<p>small hole probe (optional), code ISR-C200-SB31</p> <p>hole diameter>Ø4, depth<20</p> <p>measure holes with diameter>Ø4mm and depth<20mm</p>	<p>deep groove probe (optional), code ISR-C200-SB121</p> <p>depth<20</p> <p>measure grooves with depth<20mm</p>
<p>extension rod (optional), code ISR-C200-ER50</p> <p>for long holes</p>	<p>extension rod (optional), code ISR-C200-ER100</p> <p>for long holes</p>

BLUETOOTH

DATA
OUTPUT

CAN BE OPERATED BY
MOBILE PHONES OR COMPUTERS

ROUGHNESS TESTER CODE ISR-C002



- Roughness tester can be operated by mobile phones (only Android system) or computers
- Data can be sent to Excel by connecting to computers via bluetooth or SPC cable
- Support bluetooth printer
- 21 roughness parameters
- Display roughness value, profile and curve
- Memory of maximum 100 results
- Automatic power off



software flash disk
(included)

probe cover (included)



put the small workpieces
directly under the
probe for measurement

adjustable stand (included)



screen display



measurement result

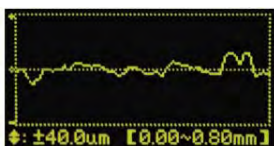

roughness profile



Rmr analysis

operate roughness tester by mobile phones



connect to mobile phones via bluetooth
(only Android system),
display roughness values, profile and curve

operate roughness tester by computers

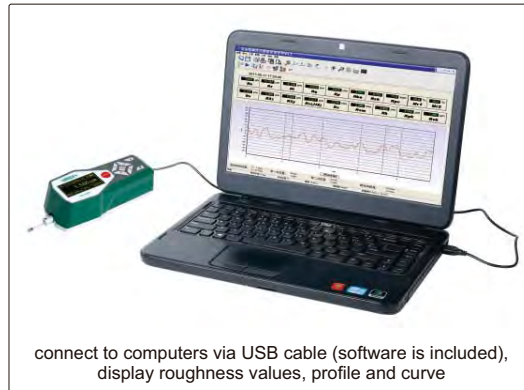

connect to computers via USB cable (software is included),
display roughness values, profile and curve

data can be sent to Excel by connecting to computer via bluetooth or SPC cable

via bluetooth

receiver
(optional)



via SPC cable

SPC cable (optional)



receiver (optional)



bluetooth printer (optional)



To be continued

Continued from previous page

Unit: mm

light duty test stand (optional)



heavy duty test stand (optional)



<p>extension rod (optional), code ISR-C002-ER</p>	<p>transverse rod (optional), code ISR-C002-TR</p>
<p>tiny hole probe (optional), code ISR-C002-SBP</p>	<p>deep groove probe (optional), code ISR-C002-DGP</p>
<p>deep groove probe (optional), code ISR-C002-DGP1</p>	

SPECIFICATION

Parameters	Ra, Rz, Rq, Rv, Rp, RS, R3z, R3y, Rt, Rz (JIS), Rk, Rku, Rsm, Rpc, Rpk, Rvk, Rsk, Mr1, Mr2, Ry (JIS), Rmax	
Range	320µm (-160µm~160µm)	
Accuracy	±10%	
Resolution (Ra)	0.001µm	
Probe	type	inductive
	stylus radius/angle	5µm/90°
	stylus material	diamond
Measuring force	4mN	
Measuring unit	µm/µin	
Cut off	0.25/0.8/2.5mm	
Number of cut-off	1 to 5	
Moving speed	0.5mm/s, 1mm/s	
Memory	100 measurement results	
Output	bluetooth and USB	
Power	built-in rechargeable battery	
Dimension (L×W×H)	141×55×40mm	
Weight	400g	

STANDARD DELIVERY

Main unit	1 pc
Standard probe	1 pc
Calibration block and support	1 pc of each
Adjustable stand	1 pc
Probe cover	1 pc
Software and USB cable	1 pc
AC/DC adapter	1 pc

OPTIONAL ACCESSORY

Extension rod	ISR-C002-ER
Transverse rod	ISR-C002-TR
Tiny hole probe	ISR-C002-SBP
Deep groove probe	ISR-C002-DGP
Deep groove probe	ISR-C002-DGP1*
Light duty test stand	ISR-C002-STAND1
Heavy duty test stand	ISR-C002-STAND
Bluetooth printer	ISR-C002-PRINTER
Receiver	ISR-C300-RECEIVER
SPC cable	ISR-C300-SPC

*Need to be delivered with roughness tester ISR-C002

BLUETOOTH

TOUCH SCREEN

CAN BE OPERATED BY COMPUTERS OR MOBILE PHONES

DATA OUTPUT

POPULAR MODEL

ROUGHNESS TESTER (SEPARABLE TYPE) CODE ISR-C300

- Roughness tester can be operated by mobile phones (only Android system) or computers
- Data can be sent to Excel by connecting to computers via bluetooth or SPC cable
- Support bluetooth printer
- 22 roughness parameters
- Meet ISO, DIN, ANSI, JIS standards
- Display roughness values, profile and curve
- Memory of maximum 100 data and waveform
- Built-in lithium battery, working time more than 50 hours
- Touch screen
- Automatic power off

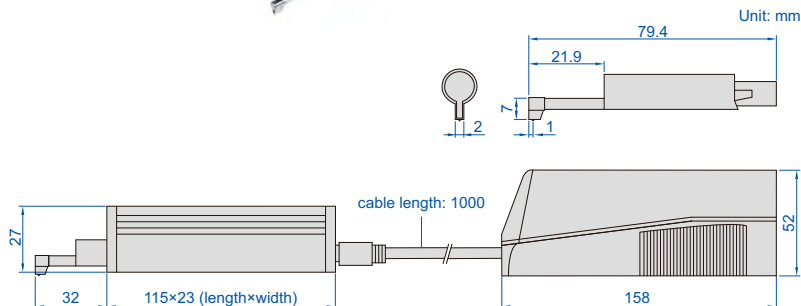

roughness tester screen display

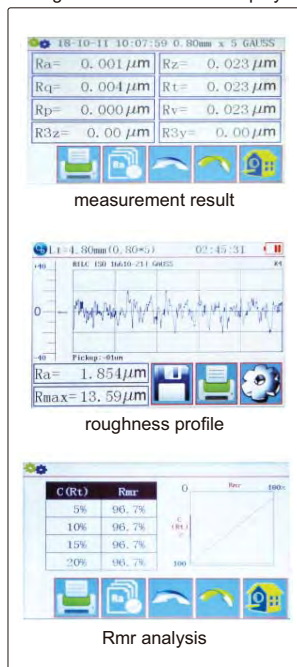

measurement result

Ra = 0.001 μm	Rz = 0.023 μm
Rq = 0.004 μm	Rt = 0.023 μm
Rp = 0.000 μm	Rv = 0.023 μm
R3z = 0.00 μm	R3y = 0.00 μm

roughness profile

Ra = 1.854 μm
Rmax = 13.59 μm

Rmr analysis

C (Rt)	Rmr	0	Rmr
5%	96.7%		
10%	96.7%		
15%	96.7%		
20%	96.7%		

probe and main unit can be combined together



software flash disk (included)

operate roughness tester by mobile phones



connect to mobile phones via bluetooth (only Android system), display roughness values, profile and curve

operate roughness tester by computers

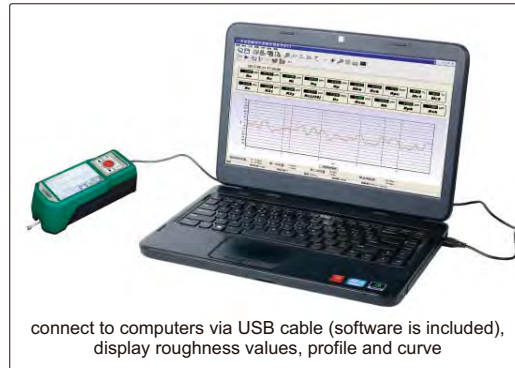

connect to computers via USB cable (software is included), display roughness values, profile and curve

To be continued

Continued from previous page

data can be sent to Excel by connecting to computer via bluetooth or SPC cable

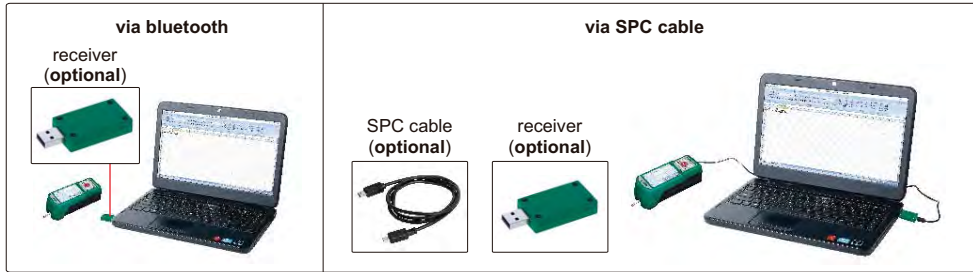

bluetooth printer (optional)



probe support (optional)

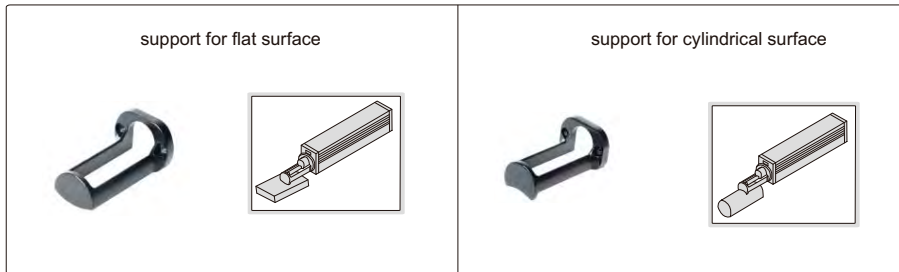

adjustable stand (included)



magnetic stand adapter (included)



height gage adapter (optional)



NOTE: Please check whether the adapter can fit your height gages. When using **INSIZE** height gages, please use the dial test indicator holder of height gages

light duty test stand (optional)



heavy duty test stand (optional)



To be continued

Continued from previous page

optional probes

Unit: mm

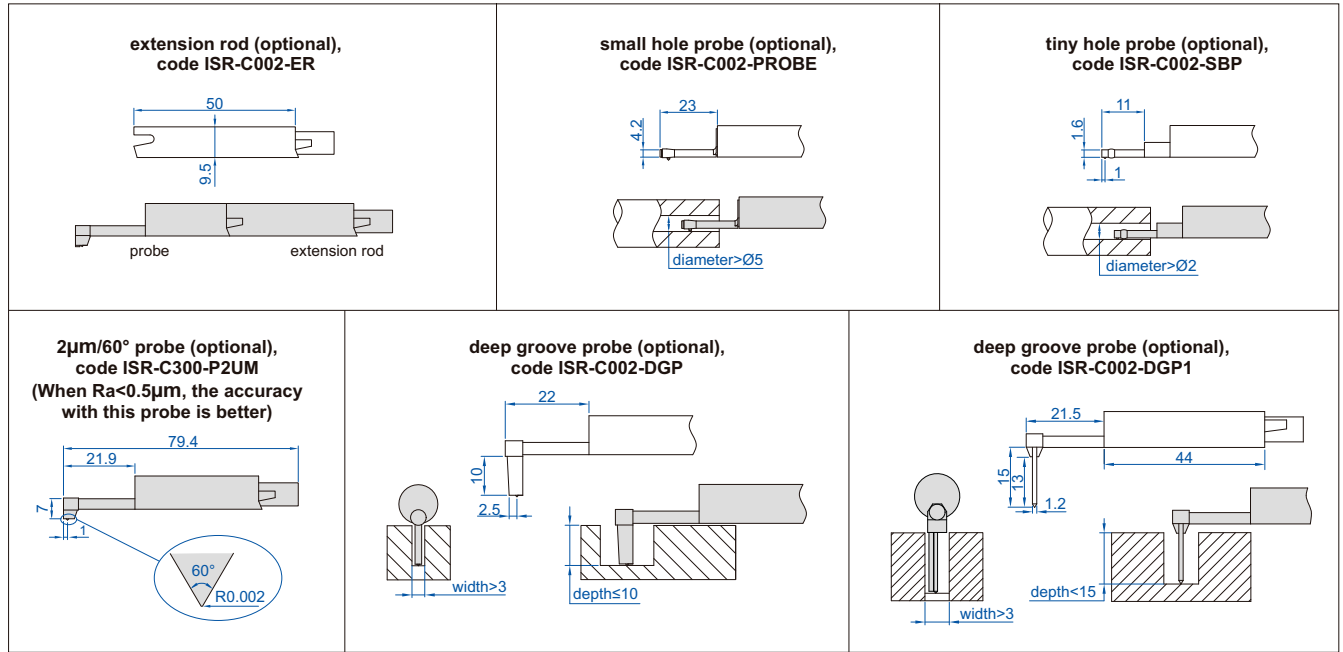

SPECIFICATION

Parameters		Ra, Rz, Rq, Rv, Rp, Rs, R3z, R3y, Rt, Rc, Rz (JIS), Rk, Rku, Rsm, Rpc, Rpk, Rvk, Rsk, Mr1, Mr2, Ry, Rmax
Range	X axis	17.5mm
	Z axis	320µm (-160µm~160µm)
Accuracy		±10%
Resolution (Ra)		0.001µm
Probe	type	inductive
	stylus radius/angle	5µm/90°
	stylus material	diamond
Measuring force		4mN
Measuring unit		µm/µin
Cut off		0.25/0.8/2.5mm
Number of cut-offs		1~5
Moving speed		0.135mm/s, 0.5mm/s, 1mm/s
Memory		100 measurement results
Output		USB and bluetooth
Power		built-in rechargeable battery
Dimension (L×W×H)		158×64×52mm
Weight		400g

STANDARD DELIVERY

Main unit	1 pc
Standard probe	1 pc
Calibration block and support	1 pc of each
Connecting cable (long and short)	1 pc of each
Magnetic stand adapter	1 pc
Adjustable stand	1 pc
Touch pen	1 pc
Software and USB cable	1 pc
AC/DC adapter	1 pc

OPTIONAL ACCESSORY

Extension rod	ISR-C002-ER
Small hole probe	ISR-C002-PROBE
Tiny hole probe	ISR-C002-SBP
Deep groove probe	ISR-C002-DGP
Deep groove probe	ISR-C002-DGP1*
2µm/60° probe	ISR-C300-P2UM
Bluetooth printer	ISR-C002-PRINTER
Height gage adapter	ISR-C300-LB1
Receiver	ISR-C300-RECEIVER
SPC cable	ISR-C300-SPC
Support for flat surface	ISR-C300-COVER1
Support for cylindrical surface	ISR-C300-COVER2
Light duty test stand	ISR-C002-STAND1
Heavy duty test stand	ISR-C002-STAND

*Need to be delivered with roughness tester ISR-C300

ROUGHNESS TESTER CODE ISR-T120

DATA
OUTPUT

BLUETOOTH

TOUCH SCREEN

CAN BE OPERATED BY
MOBILE PHONES OR COMPUTERS



- Roughness tester can be operated by mobile phones (only Android system) or computers
- Data can be sent to Excel by connecting to computers via bluetooth or SPC cable
- Built-in printer can print measurement results and graphics
- 22 roughness parameters
- Meet ISO, DIN, ANSI, JIS standards
- Display roughness values, profile and curve
- Memory of maximum 100 data and waveform
- Built-in lithium battery, working time more than 50 hours
- Automatic power off

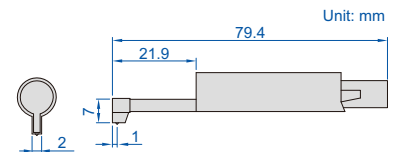

roughness tester screen display

measurement result

Ra= 0.001 μm	Rz= 0.023 μm
Rq= 0.004 μm	Rt= 0.023 μm
Rp= 0.000 μm	Rv= 0.023 μm
R3z= 0.00 μm	R3y= 0.00 μm

roughness profile

Rmr analysis

C (Rt)	Rmr	0	100
5%	96.7%		
10%	96.7%		
15%	96.7%		
20%	96.7%		

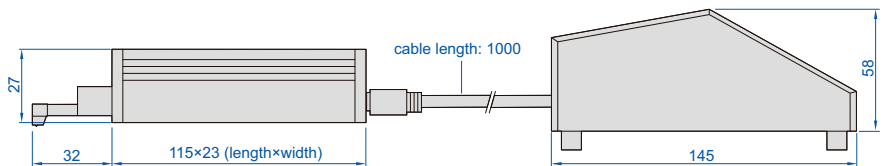

operate roughness tester by mobile phones

connect to mobile phones via bluetooth (only Android system), display roughness values, profile and curve

operate roughness tester by computers

connect to computers via USB cable (software is included), display roughness values, profile and curve

To be continued

Continued from previous page

data can be sent to Excel by connecting to computer via bluetooth or SPC cable

<p>via bluetooth</p> <p>receiver (optional)</p>	<p>via SPC cable</p> <p>SPC cable (optional)</p> <p>receiver (optional)</p>
--	--

probe support (optional)

support for cylindrical surface

support for flat surface

height gage adapter (optional)

9x9mm

can be installed on height gages

magnetic stand adapter (included)

Ø8mm

can be installed on magnetic stands

NOTE: Please check whether the adapter can fit your height gages. When using **INSIZE** height gages, please use the dial test indicator holder of height gages

optional probes

Unit: mm

<p>extension rod (optional), code ISR-C002-ER</p> <p>probe extension rod</p>	<p>small hole probe (optional), code ISR-C002-PROBE</p> <p>diameter > Ø5</p>	<p>tiny hole probe (optional), code ISR-C002-SBP</p> <p>diameter > Ø2</p>
<p>2µm/60° probe (optional), code ISR-C300-P2UM (When Ra < 0.5µm, the accuracy with this probe is better)</p>	<p>deep groove probe (optional), code ISR-C002-DGP</p> <p>width > 3 depth < 10</p>	<p>deep groove probe (optional), code ISR-C002-DGP1</p> <p>depth < 15 width > 3</p>

To be continued

Continued from previous page

light duty test stand (optional)



heavy duty test stand (optional)



SPECIFICATION

Parameters		Ra, Rz, Rq, Rv, Rp, Rs, R3z, R3y, Rt, Rc, Rz (JIS), Rk, Rku, Rsm, Rpc, Rpk, Rvk, Rsk, Mr1, Mr2, Ry, Rmax
Range	X axis	17.5mm
	Z axis	640µm (-320µm~320µm)
Accuracy		±10%
Resolution (Ra)		0.001µm
Probe	type	inductive
	stylus radius/angle	5µm/90°
	stylus material	diamond
Measuring force		4mN
Measuring unit		µm/µin
Cut off		0.25/0.8/2.5mm
Number of cut-offs		1~5
Traverse speed		0.135mm/s, 0.5mm/s, 1mm/s
Memory		100 measurement results
Output		bluetooth and USB
Power		built-in rechargeable battery
Dimension (L×W×H)		158×64×52mm
Weight		400g

STANDARD DELIVERY

Main unit	1 pc
Standard probe	1 pc
Calibration block and support	1 pc of each
Magnetic stand adapter	1 pc
Adjustable stand	1 pc
Touch pen	1 pc
Software and USB cable	1 pc
AC/DC adapter	1 pc

OPTIONAL ACCESSORY

Extension rod	ISR-C002-ER
Small hole probe	ISR-C002-PROBE
Tiny hole probe	ISR-C002-SBP
2µm/60° probe	ISR-C300-P2UM
Deep groove probe	ISR-C002-DGP
Deep groove probe	ISR-C002-DGP1 *
Height gage adapter	ISR-C300-LB1
Receiver	ISR-C300-RECEIVER
SPC cable	ISR-C300-SPC
Support for flat surface	ISR-C300-COVER1
Support for cylindrical surface	ISR-C300-COVER2
Light duty test stand	ISR-C002-STAND1
Heavy duty test stand	ISR-C002-STAND

* Need to be delivered with roughness tester ISR-T120

ATTENTION: THIS ROUGHNESS TESTER IS NOT SUITABLE FOR ROUGH TURNING, MILLING AND PLANING WORKPIECES

ROUGHNESS TESTER (BASIC TYPE) CODE ISR-C003

- Unit: μm , μin
- Automatic power off



fixture for small shafts (optional)



application



calibration block (included)

OPTIONAL ACCESSORY

Fixture for small shafts	ISR-C003-FIXTURE
--------------------------	------------------

SPECIFICATION

Parameters		Ra, Rz, Rq, Rt
Range		Ra, Rq: 0.05~15 μm Rz, Rt: 0.1~50 μm
Accuracy		$\pm 10\%$
Resolution (Ra)		0.01 μm
Probe	type	piezoelectric
	stylus radius/angle	10 $\mu\text{m}/90^\circ$
	stylus material	diamond
Measuring force		5mN
Measuring unit		$\mu\text{m}/\mu\text{in}$
Cut off		0.25/0.8/2.5mm
Evaluation length		1.25mm for cut off 0.25mm 4mm for cut off 0.8mm 5mm for cut off 2.5mm
Moving speed		0.75mm/s
Power		built-in rechargeable battery
Dimension (L×W×H)		106×70×24mm
Weight		200g

STANDARD DELIVERY

Main unit	1 pc
Calibration block	1 pc
AC/DC adapter	1 pc

SURFACE ROUGHNESS SPECIMEN SET CODE ISR-CS130-W

INSIZE PLUS
MADE IN EUROPE



- For checking, identifying and specifying the roughness by symbol
- Rust-proof, made of pure Nickel

Machining method	Roughness (Ra) *	Roughness (Rz) *	Quantity
Flat lapping	0.05, 0.1, 0.2 μm	0.55, 1, 1.6 μm	3 pcs
	2, 4, 8 μin		
Reaming	0.4, 0.8, 1.6 μm	3, 6, 10 μm	3 pcs
	16, 32, 63 μin		
Plain grinding	0.05, 0.1, 0.2, 0.4, 0.8, 1.6 μm	0.55, 1, 1.6, 3, 6, 10 μm	6 pcs
	2, 4, 8, 16, 32, 63 μin		
Horizontal milling	0.4, 0.8, 1.6, 3.2, 6.3, 12.5 μm	2.5, 4, 8, 16, 32, 50 μm	6 pcs
	16, 32, 63, 125, 250, 500 μin		
Vertical milling	0.4, 0.8, 1.6, 3.2, 6.3, 12.5 μm	2.5, 4, 8, 16, 32, 50 μm	6 pcs
	16, 32, 63, 125, 250, 500 μin		
Turning	0.4, 0.8, 1.6, 3.2, 6.3, 12.5 μm	2.5, 4, 8, 16, 32, 50 μm	6 pcs
	16, 32, 63, 125, 250, 500 μin		

* The actual value is the value to be calibrated

SURFACE ROUGHNESS SPECIMENS

INSIZE PLUS
MADE IN EUROPE



- For checking, identifying and specifying the roughness by symbol
- Rust-proof, made of pure Nickel

ISR-CS315

Code	Machining method	Roughness (Ra) *	Roughness (Rz) *	Quantity
ISR-CS315	surface grinding	0.025, 0.05, 0.1, 0.2, 0.4, 0.8, 1.6, 3.2µm	0.29, 0.55, 0.91, 1.74, 2.6, 4.65, 7.87, 15.6µm	8 pcs
ISR-CS316	cylindrical grinding	0.025, 0.05, 0.1, 0.2, 0.4, 0.8, 1.6, 3.2µm	0.3, 0.53, 0.88, 1.56, 2.64, 4.4, 7.71, 15.3µm	8 pcs
ISR-CS317	flat lapping	criss-cross	0.025, 0.05, 0.1, 0.2µm	0.4, 0.6, 0.74, 1.26µm
		parallel	0.025, 0.05, 0.1, 0.2µm	0.34, 0.56, 1.12, 1.5µm
ISR-CS318	cylindrical lapping	0.025, 0.05, 0.1, 0.2µm	0.46, 0.54, 0.63, 1.23µm	4 pcs
	superfinishing	0.025, 0.05, 0.1, 0.2µm	0.36, 0.7, 1, 1.4µm	4 pcs
ISR-CS319	face turning	0.4, 0.8, 1.6, 3.2, 6.3, 12.5, 25, 50µm	1.92, 3.2, 6.15, 12.5, 23.7, 48.7, 102, 185µm	8 pcs
ISR-CS320	cylindrical turning	0.4, 0.8, 1.6, 3.2, 6.3, 12.5, 25, 50µm	1.7, 3.2, 6.1, 12.2, 23.7, 47.5, 95, 190µm	8 pcs
ISR-CS321	end milling	0.4, 0.8, 1.6, 3.2, 6.3, 12.5, 25, 50µm	1.92, 3.82, 6.45, 12.2, 25.2, 49.8, 92.6, 191µm	8 pcs
ISR-CS322	reaming	0.4, 0.8, 1.6, 3.2µm	1.7, 3.2, 6.4, 12.8µm	4 pcs
	drilling	1.6, 3.2, 6.3, 12.5µm	7.5, 15.5, 31, 60µm	4 pcs
ISR-CS323	horizontal milling	0.4, 0.8, 1.6, 3.2, 6.3, 12.5, 25, 50µm	1.8, 3.68, 6.63, 12.8, 25.6, 53, 97.5, 197µm	8 pcs
ISR-CS325	shaping (planing)	0.8, 1.6, 3.2, 6.3, 12.5, 25, 50, 100µm	3.84, 6.7, 12.2, 25.2, 48.7, 99.9, 190, 361µm	8 pcs
ISR-CS326	linishing (belt sanding)	0.1, 0.2, 0.4, 0.8, 1.6, 3.2µm	0.9, 1.55, 3.37, 7.42, 18.5, 31µm	6 pcs
ISR-CS328	vertical grinding	0.2, 0.4, 0.8, 1.6, 3.2, 6.3µm	1.1, 3.5, 6.15, 8.78, 22.19, 40.8µm	6 pcs
ISR-CS329	grit blasting	3.2, 10.5, 18, 25µm	19.2, 63, 108, 150µm	4 pcs
	shot blasting	3.2, 8, 13, 18µm	19.2, 48, 78, 108µm	4 pcs
ISR-CS331	spark erosion (EDM)	0.4, 0.8, 1.6, 3.2, 6.3, 12.5, 25, 50µm	2.5, 4.5, 7.2, 14.2, 24.7, 51.2, 105, 196µm	8 pcs
ISR-CS333	hand filing	0.4, 0.8, 1.6, 3.2, 6.3µm	3, 5.6, 12.4, 22.5, 61µm	5 pcs
ISR-CS334	castings	0.8, 1.6, 3.2, 6.3, 12.5, 25, 50µm	3.2, 8, 16, 32, 56, 112, 225µm	7 pcs
ISR-CS335	honing	0.05, 0.1, 0.2, 0.4, 0.8, 1.6µm	0.31, 0.56, 1, 2, 4.2, 9µm	6 pcs
ISR-CS336	polishing	0.0125, 0.025, 0.05, 0.1, 0.2µm	0.29, 0.35, 0.67, 0.72, 1.52µm	5 pcs

* The actual value is the value to be calibrated

SHOT AND GRIT BLASTING SURFACE ROUGHNESS SPECIMENS

INSIZE PLUS
MADE IN EUROPE



ISR-CS017

- To check the roughness of steel surfaces which have been blast cleaned before painting
- Meets ISO 8503/1
- Rust-proof, made of pure Nickel
- Each piece contains 4 parts

Code	Machining method	Roughness (Ra) *	Roughness (Rz) *
ISR-CS017	shot blasting	3.2, 8, 13, 18µm	19.2, 48, 78, 108µm
ISR-CS018	grit blasting	3.2, 10.5, 18, 25µm	19.2, 63, 108, 150µm

* The actual value is the value to be calibrated

MEASURING ACCURACY OF ROUGHNESS TESTERS CAN BE IMPROVED, IF THE CALIBRATION IS MADE ON A REFERENCE SPECIMEN WITH THE ROUGHNESS VALUE CLOSE TO THE WORKPIECE TO BE MEASURED

SURFACE ROUGHNESS REFERENCE SPECIMENS

INSIZE PLUS
MADE IN EUROPE

- To calibrate roughness testers
- Meets ISO 5436-1: 2000
- Rust proof, made of pure Nickel

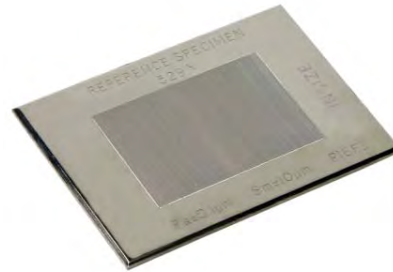

ISR-RS529X

Code	Roughness (Ra)
ISR-RS525X	6.25µm *
ISR-RS526X	3.15µm *
ISR-RS527X	3.0µm *
ISR-RS528X	0.5µm *
ISR-RS529X	0.1µm *
ISR-RS530X	1.0µm *
ISR-RS531X	0.3µm *

*The actual value may be slightly different

MEASURING ACCURACY OF ROUGHNESS TESTERS CAN BE IMPROVED, IF THE CALIBRATION IS MADE ON A REFERENCE SPECIMEN WITH THE ROUGHNESS VALUE CLOSE TO THE WORKPIECE TO BE MEASURED

SURFACE ROUGHNESS REFERENCE SPECIMENS

- To calibrate roughness testers
- Made of glass



ISR-LS603

Code	Roughness (Ra)	Deviation *	Uniformity
ISR-LS601	0.1µm	-20% ~ +10%	3%
ISR-LS602	0.2µm	±10%	3%
ISR-LS603	0.4µm	±10%	3%
ISR-LS604	0.8µm	±10%	3%
ISR-LS605	1.6µm	±10%	3%
ISR-LS606	3.2µm	±10%	2%
ISR-LS607	6.4µm	±10%	2%

*Deviation between the actual value when supply and the nominal value



Rockwell Hardness Testers
Page 698-712



Micro-Vickers Hardness Testers
Page 713-719



Vickers Hardness Testers
Page 720



Vickers Hardness Measuring Systems
Page 714/721



Brinell Hardness Testers
Page 722-724



Brinell Indentation Measuring Systems
Page 725



Brinell/Rockwell/Vickers Hardness Testers
Page 726-727



Leeb Hardness Testers
Page 728-737



Magnetic Rockwell Hardness Testers
Page 738-739



Magnetic Brinell/Rockwell Hardness Testers
Page 739



Portable Rockwell Hardness Testers
Page 740



Pin Brinell Hardness Testers
Page 740-741



Hydraulic Brinell Hardness Testers
Page 741



Chain Type Hydraulic Brinell Hardness Testers
Page 742



Aluminum Hardness Testers
Page 742



Barcol Hardness Testers
Page 743



Shore Durometers
Page 743-746



Fruit Hardness Testers
Page 746



Hardness Test Blocks
Page 747-748



Concrete Strength Testers
Page 749

MOTORIZED DIGITAL ROCKWELL HARDNESS TESTERS (DOLPHIN-NOSE TYPE)

DATA OUTPUT

FORCE LOADING BY ELECTRIC MOTOR (WITHOUT WEIGHTS)

INSPECTION CERTIFICATE

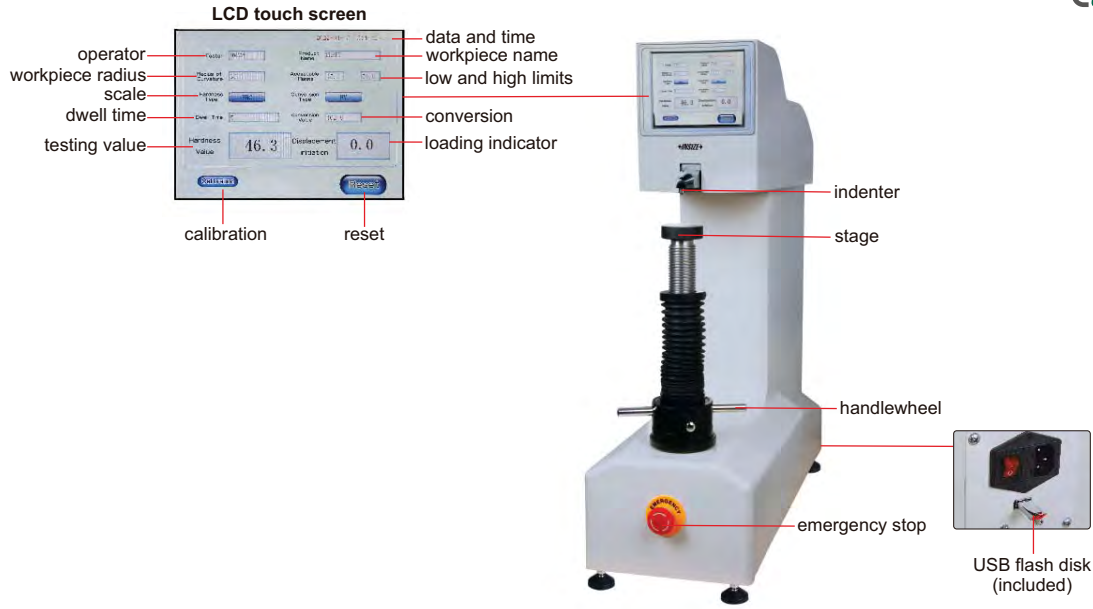

ISHR-T100



Ø63mm flat anvil (included)



Ø150mm flat anvil (included)



level (included)



touch pen (included)



V-type anvil (included) for cylinders with diameter Ø4-60mm



desk (optional)



small V-type anvil (optional) for cylinders with diameter Ø2-4mm

- Dolphin-nose indenter to reach interior of pipe and groove
- Automatic testing after preliminary test force is loaded by hand
- LCD touch screen, easy operation
- Convert to other Rockwell scales, HV or HB automatically
- Tolerance testing
- Insert USB disk, save the testing results as Excel
- Self-compensation of the hardness value for curved workpiece
- Force loading by electric motor (without weights)
- The test force is selected automatically according to hardness scale
- According to ISO 6508

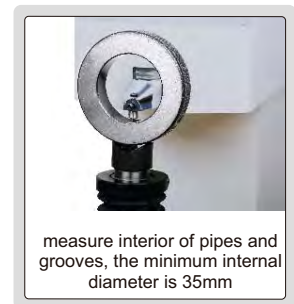

To be continued



Continued from previous page

SPECIFICATION

Code		ISHR-T100	ISHR-T200	ISHR-T300
Type		Rockwell	Superficial Rockwell	Rockwell and Superficial Rockwell
Hardness scale	with standard indenter	HRA, HRB, HRC, HRD, HRF, HRG	HR15N, HR30N, HR45N, HR15T, HR30T, HR45T	HRA, HRB, HRC, HRD, HRF, HRG, HR15N, HR30N, HR45N, HR15T, HR30T, HR45T
	with optional indenter	HRE, HRH, HRK, HRL, HRM, HRP, HRR, HRS, HRV	HR15W, HR30W, HR45W, HR15X, HR30X, HR45X, HR15Y, HR30Y, HR45Y	HRE, HRH, HRK, HRL, HRM, HRP, HRR, HRS, HRV, HR15W, HR30W, HR45W, HR15X, HR30X, HR45X, HR15Y, HR30Y, HR45Y
Preliminary test force		98N/10kgf for Rockwell	29.4N/3kgf for Superficial Rockwell	98N/10kgf for Rockwell 29.4N/3kgf for Superficial Rockwell
Test force		588N (60kg), 980N (100kg), 1471N (150kg)	147.1N (15kg), 294.2N (30kg), 441.3N (45kg)	147.1N (15kg), 294.2N (30kg), 441.3N (45kg), 588N (60kg), 980N (100kg), 1471N (150kg)
Stage elevation		manual		
Load control		automatic (load/dwell/unload)		
Load dwell time		0~99 second		
Resolution		0.1HR		
Output		USB		
Max. workpiece height		300mm		
Max. testing width		250mm (from the center of indenter to the wall of main body)		
Power supply		220V, 50/60Hz		
Dimension		720×260×840mm		
Weight		80kg		

STANDARD DELIVERY

Code	ISHR-T100	ISHR-T200	ISHR-T300
Main unit	1 pc	1 pc	1 pc
Ø63mm flat anvil	1 pc	1 pc	1 pc
Ø150mm flat anvil	1 pc	1 pc	1 pc
V-type anvil	1 pc	1 pc	1 pc
Diamond indenter	1 pc	1 pc	1 pc
Ø1.5875mm carbide ball indenter	1 pc	1 pc	1 pc
Hardness test block HRB88~95	1 pc	—	1 pc
Hardness test block HRC60~65	1 pc	—	1 pc
Hardness test block HRC20~30	1 pc	—	1 pc
Hardness test block 78~88HR15N	—	1 pc	1 pc
Hardness test block 55~73HR30N	—	1 pc	1 pc
Hardness test block 57~69HR30T	—	1 pc	1 pc
USB disk	1 pc	1 pc	1 pc
Level	1 pc	1 pc	1 pc
Touch pen	1 pc	1 pc	1 pc
Anti-dust cover	1 pc	1 pc	1 pc

OPTIONAL ACCESSORY

Hardness test block HRB88~100	HDT-B-HRB
Hardness test block HRC60~70	HDT-B-HRC3
Hardness test block HRC20~30	HDT-B-HRC1
Hardness test block 78~88HR15N	HDT-B-HR15N2
Hardness test block 55~73HR30N	HDT-B-HR30N2
Hardness test block 73~82HR30T	HDT-B-HR30T
Small V-type anvil	ISH-SMALLANVIL
Desk	HDT-DESK

AUTOMATIC DIGITAL ROCKWELL/SUPERFICIAL ROCKWELL HARDNESS TESTERS (FOR MASS PRODUCTION)

AUTOMATIC LIFTING OF STAGE
AUTOMATIC LOADING AND UNLOADING

DATA
OUTPUT

FORCE LOADING BY ELECTRIC
MOTOR (WITHOUT WEIGHTS)

INSPECTION
CERTIFICATE

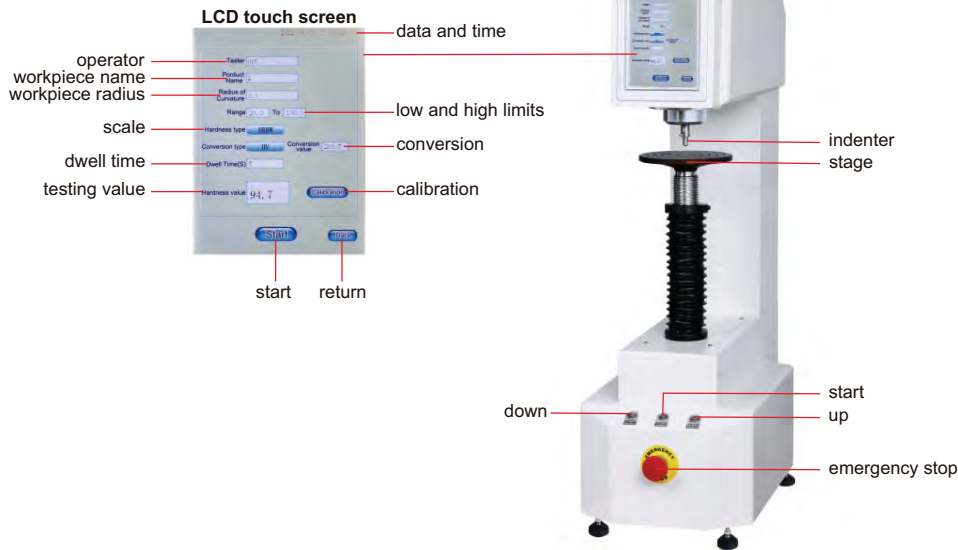

HDT-A410



Ø63mm flat anvil
(included)



Ø150mm flat anvil
(included)



level (included)



touch pen (included)



V-type anvil (included) for
cylinders with
diameter Ø4-60mm



small V-type anvil (optional)
for cylinders with
diameter Ø2-4mm



desk (optional)

- According to BSEN 6508, ISO 6508, ASTM E18
- Automatic lifting of stage without manual rotation
- Automatic testing, the preliminary and main test force are loaded automatically
- LCD touch screen, easy operation
- Convert to other Rockwell scales, HV or HB automatically
- Tolerance testing
- Insert USB flash disk, save the testing results as Excel
- Self-correcting the hardness value for curved workpieces
- The accuracy can be corrected with three standard blocks of low, medium and high values
- The loading force can be corrected with standard force gages
- Force loading by electric motor (without weights)
- The test force is selected automatically according to hardness scales

To be continued



Continued from previous page

SPECIFICATION

Code		HDT-A410	HDT-A510	HDT-A610
Type		Rockwell	Superficial Rockwell	Rockwell and Superficial Rockwell
Hardness scale	with standard indenters	HRA, HRB, HRC, HRD, HRF, HRG	HR15N, HR30N, HR45N, HR15T, HR30T, HR45T	HRA, HRB, HRC, HRD, HRF, HRG, HR15N, HR30N, HR45N, HR15T, HR30T, HR45T
	with optional indenter	HRE, HRH, HRK, HRL, HRM, HRP, HRR, HRS, HRV	HR15W, HR30W, HR45W, HR15X, HR30X, HR45X, HR15Y, HR30Y, HR45Y	HRE, HRH, HRK, HRL, HRM, HRP, HRR, HRS, HRV, HR15W, HR30W, HR45W, HR15X, HR30X, HR45X, HR15Y, HR30Y, HR45Y
Preliminary test force		98N/10kgf for Rockwell	29.4N/3kgf for Superficial Rockwell	98N/10kgf for Rockwell 29.4N/3kgf for Superficial Rockwell
Test force		588N (60kg), 980N (100kg), 1471N (150kg)	147.1N (15kg), 294.2N (30kg), 441.3N (45kg)	147.1N (15kg), 294.2N (30kg), 441.3N (45kg), 588N (60kg), 980N (100kg), 1471N (150kg)
Stage lifting		automatic		
Load control		automatic (load/dwell/unload)		
Load dwell time		0~99 second		
Resolution		0.1HR		
Output		USB		
Max. workpiece height		300mm		
Max. testing width		200mm (from the center of indenter to the wall of main body)		
Power supply		220V, 50/60Hz		
Dimension		560×280×850mm		
Weight		80kg		

STANDARD DELIVERY

Code	HDT-A410	HDT-A510	HDT-A610
Main unit	1 pc	1 pc	1 pc
Ø63mm flat anvil	1 pc	1 pc	1 pc
Ø150mm flat anvil	1 pc	1 pc	1 pc
V-type anvil	1 pc	1 pc	1 pc
Diamond indenter	1 pc	1 pc	1 pc
Ø1.5875mm carbide ball indenter	1 pc	1 pc	1 pc
Hardness test block HRB88~95	1 pc	—	1 pc
Hardness test block HRC60~65	1 pc	—	1 pc
Hardness test block HRC20~30	1 pc	—	1 pc
Hardness test block 78~88HR15N	—	1 pc	1 pc
Hardness test block 55~73HR30N	—	1 pc	1 pc
Hardness test block 57~69HR30T	—	1 pc	1 pc
USB flash disk (8G)	1 pc	1 pc	1 pc
Level	1 pc	1 pc	1 pc
Touch pen	1 pc	1 pc	1 pc
Anti-dust cover	1 pc	1 pc	1 pc

OPTIONAL ACCESSORY

Hardness test block HRB88~100	HDT-B-HRB
Hardness test block HRC60~70	HDT-B-HRC3
Hardness test block HRC20~30	HDT-B-HRC1
Hardness test block 78~88HR15N	HDT-B-HR15N2
Hardness test block 55~73HR30N	HDT-B-HR30N2
Hardness test block 73~82HR30T	HDT-B-HR30T
Small V-type anvil	ISH-SMALLANVIL
Desk	HDT-DESK

MOTORIZED DIGITAL ROCKWELL/SUPERFICIAL ROCKWELL HARDNESS TESTERS

DATA
OUTPUT

FORCE LOADING BY ELECTRIC
MOTOR (WITHOUT WEIGHTS)

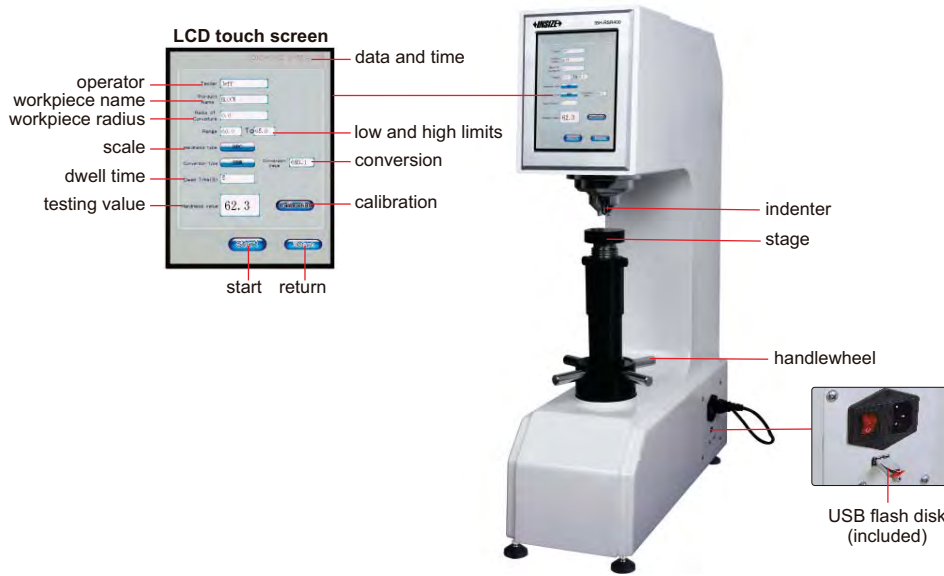

ISH-RSR400



Ø63mm flat anvil
(included)



Ø150mm flat anvil
(included)



level (included)



touch pen (included)



V-type anvil (included) for
cylinders with
diameter Ø4~60mm



small V-type anvil (optional)
for cylinders with
diameter Ø2~4mm



desk (optional)

- Automatic testing, the preliminary and main test force are loaded automatically
- LCD touch screen, easy operation
- Convert to other Rockwell scales, HV or HB automatically
- Tolerance testing
- Insert USB flash disk, save the testing results as Excel
- Self-correcting the hardness value for curved workpieces
- Force loading by electric motor (without weights)
- The test force is selected automatically according to hardness scale
- According to ISO 6508

automatic testing



To be continued



Continued from previous page

SPECIFICATION

Code		ISH-RSR400	ISH-RSR500	ISH-RSR600
Type		Rockwell	Superficial Rockwell	Rockwell and Superficial Rockwell
Hardness scale	with standard indenters	HRA, HRB, HRC, HRD, HRF, HRG	HR15N, HR30N, HR45N, HR15T, HR30T, HR45T	HRA, HRB, HRC, HRD, HRF, HRG, HR15N, HR30N, HR45N, HR15T, HR30T, HR45T
	with optional indenter	HRE, HRH, HRK, HRL, HRM, HRP, HRR, HRS, HRV	HR15W, HR30W, HR45W, HR15X, HR30X, HR45X, HR15Y, HR30Y, HR45Y	HRE, HRH, HRK, HRL, HRM, HRP, HRR, HRS, HRV, HR15W, HR30W, HR45W, HR15X, HR30X, HR45X, HR15Y, HR30Y, HR45Y
Preliminary test force		98N/10kgf for Rockwell	29.4N/3kgf for Superficial Rockwell	98N/10kgf for Rockwell 29.4N/3kgf for Superficial Rockwell
Test force		588N (60kg), 980N (100kg), 1471N (150kg)	147.1N (15kg), 294.2N (30kg), 441.3N (45kg)	147.1N (15kg), 294.2N (30kg), 441.3N (45kg), 588N (60kg), 980N (100kg), 1471N (150kg)
Stage elevation		manual		
Load control		automatic (load/dwell/unload)		
Load dwell time		0~60 second		
Resolution		0.1HR		
Output		USB		
Max. workpiece height		220mm		
Max. testing width		200mm (from the center of indenter to the wall of main body)		
Power supply		220V, 50/60Hz		
Dimension		510×260×780mm		
Weight		70kg		

STANDARD DELIVERY

Code	ISH-RSR400	ISH-RSR500	ISH-RSR600
Main unit	1 pc	1 pc	1 pc
Ø63mm flat anvil	1 pc	1 pc	1 pc
Ø150mm flat anvil	1 pc	1 pc	1 pc
V-type anvil	1 pc	1 pc	1 pc
Diamond indenter	1 pc	1 pc	1 pc
Ø1.5875mm carbide ball indenter	1 pc	1 pc	1 pc
Hardness test block HRB88~95	1 pc	—	1 pc
Hardness test block HRC60~65	1 pc	—	1 pc
Hardness test block HRC20~30	1 pc	—	1 pc
Hardness test block 78~88HR15N	—	1 pc	1 pc
Hardness test block 55~73HR30N	—	1 pc	1 pc
Hardness test block 57~69HR30T	—	1 pc	1 pc
USB flash disk (8G)	1 pc	1 pc	1 pc
Level	1 pc	1 pc	1 pc
Touch pen	1 pc	1 pc	1 pc
Anti-dust cover	1 pc	1 pc	1 pc

OPTIONAL ACCESSORY

Hardness test block HRB88~100	HDT-B-HRB
Hardness test block HRC60~70	HDT-B-HRC3
Hardness test block HRC20~30	HDT-B-HRC1
Hardness test block 78~88HR15N	HDT-B-HR15N2
Hardness test block 55~73HR30N	HDT-B-HR30N2
Hardness test block 73~82HR30T	HDT-B-HR30T
Small V-type anvil	ISH-SMALLANVIL
Desk	HDT-DESK

MOTORIZED DIGITAL ROCKWELL/SUPERFICIAL ROCKWELL HARDNESS TESTERS



FORCE LOADING BY ELECTRIC MOTOR (WITHOUT WEIGHTS)

TOUCH SCREEN

BUILT-IN BLUETOOTH



Ø58mm flat anvil (included)



Ø150mm flat anvil (included)



V-type anvil (included)



bluetooth printer (included)



8" touch screen

test scales
standard selection
setting
testing
display
chart

load dwell time
converted scales
hardness value correction
program setting

the back

power
RS232 interface



HDT-RT151

- Electronic loading test force, high accuracy of force value, and stable measurement value
- Touch screen operation and display, simple operation interface
- 15 types of Rockwell hardness scales can be tested
- Convertible to various hardness standards such as HB and HV
- 500 sets of storage
- With correction function, the hardness value can be corrected based on the size of the cylinders
- According to ISO 6508

test interface

indenter type
test force
load dwell time
test force curve

test result display interface

test scale
converted scale
standard selection
test result
converted scale

chart interface

test information
chart data
select all
delete
print
test scale
converted scale
maximum value
minimum value
average value
deviation range

SEL	NUM	MEAS	CORR	RANG	MAX
1	567	H0.5	D0	60.1	60.1
2	568	H1.5	D0	58.7	58.7
3	569	H3.0	D0	59.5	59.5
4	570	H5.0	D0	58.8	58.8
5	571	H7.0	D0	59.5	59.5
6	572	H10.0	D0	58.8	58.8
7	573	H15.0	D0	59.5	59.5
8	574	H20.0	D0	58.8	58.8
9	575	H30.0	D0	59.5	59.5
10	576	H45.0	D0	58.8	58.8
MEAN	HRC	2.00	HRA	1.4	

To be continued



Continued from previous page

SPECIFICATION

Code		HDT-RT151	HDT-RT152	HDT-RT153
Type		Rockwell	Superficial Rockwell	Rockwell and Superficial Rockwell
Measurement range		20~88HRA, 20~100HRB, 20~70HRC	70~91HR15N, 42~80HR30N, 42~70HR45N, 73~93HR15T, 43~82HR30T, 12~72HR45T	Rockwell: 20~88HRA, 20~100HRB, 20~70HRC; Superficial Rockwell: 70~91HR15N, 42~80HR30N, 42~70HR45N, 73~93HR15T, 43~82HR30T, 12~72HR45T
Hardness scale	with indenter included	HRA, HRB, HRC, HRD, HRF, HRG	HR15N, HR30N, HR45N, HR15T, HR30T, HR45T	HRA, HRB, HRC, HRD, HRF, HRG, HR15N, HR30N, HR45N, HR15T, HR30T, HR45T
	with optional indenter	HRE, HRH, HRK, HRL, HRM, HRP, HRR, HRS, HRV	HR15W, HR30W, HR45W, HR15X, HR30X, HR45X, HR15Y, HR30Y, HR45Y	HRE, HRH, HRK, HRL, HRM, HRP, HRR, HRS, HRV, HR15W, HR30W, HR45W, HR15X, HR30X, HR45X, HR15Y, HR30Y, HR45Y
Preliminary test force		98N/10kgf for Rockwell	29.4N/3kgf for Superficial Rockwell	98N/10kgf for Rockwell 29.4N/3kgf for Superficial Rockwell
Test force		588N (60kg), 980N (100kg), 1471N (150kg)	147N (15kg), 294N (30kg), 441N (45kg)	147N (15kg), 294N (30kg), 441N (45kg), 588N (60kg), 980N (100kg), 1471N (150kg)
Stage elevation		manual		
Load control		automatic (load/dwell/unload)		
Load dwell time		2~60 second		
Resolution		0.1HR		
Max. workpiece height		230mm		
Max. testing width		170mm		
Power supply		100~240V, 50/60Hz		
Dimension		475×200×700mm		
Weight		70kg		

STANDARD DELIVERY

Code	HDT-RT151	HDT-RT152	HDT-RT153
Main unit	1 pc	1 pc	1 pc
Diamond indenter	1 pc	1 pc	1 pc
Ø1.5875mm carbide ball indenter	1 pc	1 pc	1 pc
Ø58mm flat anvil	1 pc	1 pc	1 pc
Ø150mm flat anvil	1 pc	1 pc	1 pc
V-type anvil	1 pc	1 pc	1 pc
Hardness test block HRC20~30	1 pc	—	1 pc
Hardness test block HRC40~50	1 pc	—	—
Hardness test block HRC60~70	1 pc	—	1 pc
Hardness test block HRBW80~100	1 pc	—	1 pc
Hardness test block HRA80~90	1 pc	—	—
Hardness test block HR15N80~90	—	1 pc	—
Hardness test block HR30N60~85	—	1 pc	1 pc
Hardness test block HR30TW70~85	—	1 pc	1 pc
Bluetooth printer	1 pc	1 pc	1 pc
Anti-dust cover	1 pc	1 pc	1 pc

OPTIONAL ACCESSORY

Hardness test block HRC20~30	HDT-B-HRC1
Hardness test block HRC60~70	HDT-B-HRC3
Hardness test block HRB80~100	HDT-B-HRB
Hardness test block HR15N78~88	HDT-B-HR15N2
Hardness test block HR30N55~73	HDT-B-HR30N2
Hardness test block HR30T73~82	HDT-B-HR30T

MOTORIZED DIGITAL ROCKWELL HARDNESS TESTER CODE ISH-MRD200

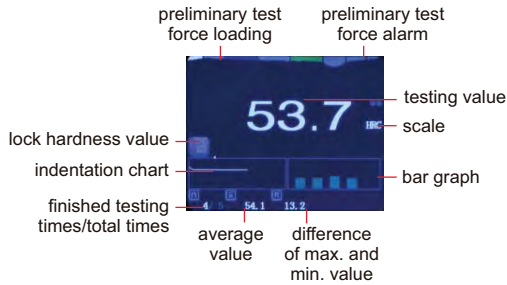

software flash disk (included)

- Tolerance testing
- Set testing times (2~10) to have average value and the difference of max. and min. value
- Convert to other Rockwell scales, HV or HB
- Memory of 500 testing values for browsing and output
- Testing value can be sent to wireless printer automatically
- Calibration function compensates the testing value for high accuracy
- The hardness value of soft materials like plastic is not stable, the lock function can obtain the value automatically
- Display unit is automatic power off
- According to ISO 6508
- Keyboard signal, can be transmitted to Excel



Ø60mm flat anvil (included)



Ø150mm flat anvil (included)



V-type anvil (included) for cylinders with diameter Ø4~60mm



small V-type anvil (optional) for cylinders with diameter Ø2~4mm



wireless printer (optional)



desk (optional)

SPECIFICATION

Hardness scale	HRA, HRB, HRC, HRD HRF, HRG (with standard indenters) HRE, HRH, HRK (with optional indenter)
Preliminary test force	98N
Test force	588N, 980N, 1471N
Stage elevation	manual
Load control	automatic (load/dwell/unload)
Load dwell time	1~99 second
Resolution	0.1HR
Output	wireless and USB
Memory	500
Max. workpiece height	170mm
Max. testing width	165mm (from the center of indenter to the wall of main body)
Power supply of the display unit	built-in rechargeable battery
Power supply	220V, 50/60Hz
Dimension	520×160×700mm
Weight	60kg

STANDARD DELIVERY

Main unit	1 pc
Ø60mm flat anvil	1 pc
Ø150mm flat anvil	1 pc
V-type anvil	1 pc
Diamond indenter	1 pc
Ø1.5875mm carbide ball indenter	1 pc
Hardness test block HRB88~95	1 pc
Hardness test block HRC60~65	1 pc
Hardness test block HRC20~30	1 pc
Anti-dust cover	1 pc
Software and USB cable	1 pc
AC/DC adapter	1 pc

OPTIONAL ACCESSORY

Wireless printer	ISH-DS-PRINTER
Ø3.175mm carbide ball indenter	ISH-EHK-INDENTER
Hardness test block HRB88~100	HDT-B-HRB
Hardness test block HRC60~70	HDT-B-HRC3
Hardness test block HRC20~30	HDT-B-HRC1
Small V-type anvil	ISH-SMALLANVIL
Desk	HDT-DESK

DATA
OUTPUT

INSPECTION
CERTIFICATE

MANUAL DIGITAL ROCKWELL HARDNESS TESTER CODE ISH-RD200

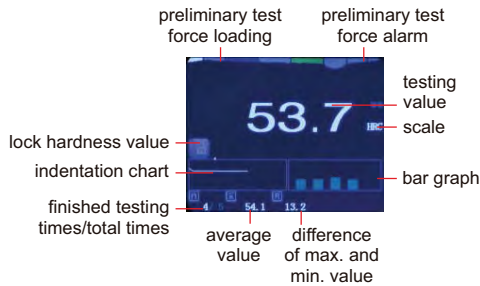

- Tolerance testing
- Set testing times (2~10) to have average value and the difference of max. and min. value
- Convert to other Rockwell scales, HV or HB
- Memory of 500 testing values for browsing and output
- Testing value can be sent to wireless printer automatically
- Calibration function compensates the testing value for high accuracy
- The hardness value of soft materials like plastic is not stable, the lock function can obtain the value automatically
- Automatic power off
- According to ISO 6508
- Keyboard signal, can be transmitted to Excel



software flash disk (included)



Ø60mm flat anvil (included)



Ø150mm flat anvil (included)



V-type anvil (included) for cylinders with diameter Ø4~60mm



small V-type anvil (optional) for cylinders with diameter Ø2~4mm



wireless printer (optional)



desk (optional)

SPECIFICATION

Hardness scale	HRA, HRB, HRC, HRD HRF, HRG (with standard indenters) HRE, HRH, HRK (with optional indenter)
Preliminary test force	98N
Test force	588N, 980N, 1471N
Stage elevation	manual
Load control	manual
Resolution	0.1HR
Output	wireless and USB
Memory	500
Max. workpiece height	170mm
Max. testing width	165mm (from the center of indenter to the wall of main body)
Power supply	built-in rechargeable battery
Dimension	520×160×700mm
Weight	60kg

STANDARD DELIVERY

Main unit	1 pc
Ø60mm flat anvil	1 pc
Ø150mm flat anvil	1 pc
V-type anvil	1 pc
Diamond indenter	1 pc
Ø1.5875mm carbide ball indenter	1 pc
Hardness test block HRB88~95	1 pc
Hardness test block HRC60~65	1 pc
Hardness test block HRC20~30	1 pc
Anti-dust cover	1 pc
Software and USB cable	1 pc
AC/DC adapter	1 pc

OPTIONAL ACCESSORY

Wireless printer	ISH-DS-PRINTER
Ø3.175mm carbide ball indenter	ISH-EHK-INDENTER
Hardness test block HRB88~100	HDT-B-HRB
Hardness test block HRC60~70	HDT-B-HRC3
Hardness test block HRC20~30	HDT-B-HRC1
Small V-type anvil	ISH-SMALLANVIL
Desk	HDT-DESK

MOTORIZED ROCKWELL HARDNESS TESTER CODE ISH-MR150

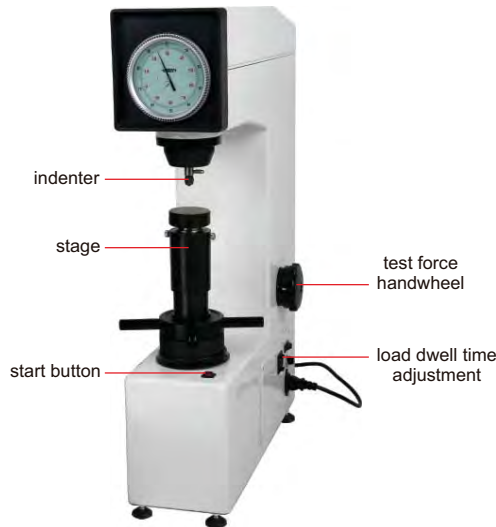

■ According to ISO 6508



Ø60mm flat anvil
(included)



Ø150mm flat anvil
(included)



V-type anvil (included)
for cylinders with
diameter Ø4~60mm



small V-type anvil
(optional)
for cylinders with
diameter Ø2~4mm



desk (optional)

SPECIFICATION

Hardness scale	HRA, HRB, HRC, HRD, HRF, HRG
Preliminary test force	98N
Test force	588N, 980N, 1471N
Display	analogue
Stage elevation	manual
Load control	automatic (load/dwell/unload)
Load dwell time	1~99 second
Min. reading	0.5HR
Max. workpiece height	170mm
Max. testing width	165mm (from the center of indenter to the wall of main body)
Power supply	220V, 50/60Hz
Dimension	520×160×700mm
Weight	60kg

STANDARD DELIVERY

Main unit	1 pc
Ø60mm flat anvil	1 pc
Ø150mm flat anvil	1 pc
V-type anvil	1 pc
Diamond indenter	1 pc
Ø1.5875mm carbide ball indenter	1 pc
Hardness test block HRB88~95	1 pc
Hardness test block HRC60~65	1 pc
Hardness test block HRC20~30	1 pc
Anti-dust cover	1 pc

OPTIONAL ACCESSORY

Hardness test block HRB88~100	HDT-B-HRB
Hardness test block HRC60~70	HDT-B-HRC3
Hardness test block HRC20~30	HDT-B-HRC1
Small V-type anvil	ISH-SMALLANVIL
Desk	HDT-DESK

MOTORIZED ROCKWELL HARDNESS TESTER (BASIC TYPE) CODE HDT-RA151



■ According to ISO 6508



Ø58mm flat anvil
(included)



Ø150mm flat anvil
(included)



V-type anvil (included)
for cylinders with
diameter Ø4~60mm



level (included)



small V-type anvil
(optional) for
cylinders with
diameter Ø2~4mm



desk (optional)

SPECIFICATION

Hardness scale	HRA, HRB, HRC, HRD, HRF, HRG
Preliminary test force	98N
Test force	588N, 980N, 1471N
Display	analogue
Stage elevation	manual
Load control	automatic (load/dwell/unload)
Load dwell time	1~60 second
Min. reading	0.5HR
Max. workpiece height	170mm
Max. testing width	128mm (from the center of indenter to the wall of main body)
Power supply	220V, 50/60Hz
Dimension	520×225×640mm
Weight	65kg

STANDARD DELIVERY

Main unit	1 pc
Ø58mm flat anvil	1 pc
Ø150mm flat anvil	1 pc
V-type anvil	1 pc
Diamond indenter	1 pc
Ø1.5875mm steel ball indenter	1 pc
Level	1 pc
Hardness test block HRA80~88	1 pc
Hardness test block HRB85~95	1 pc
Hardness test block HRC20~30	1 pc
Hardness test block HRC35~55	1 pc
Hardness test block HRC60~70	1 pc
Anti-dust cover	1 pc

OPTIONAL ACCESSORY

Hardness test block HRA80~84	HDT-B-HRA
Hardness test block HRB88~100	HDT-B-HRB
Hardness test block HRC20~30	HDT-B-HRC1
Hardness test block HRC35~55	HDT-B-HRC2
Hardness test block HRC60~70	HDT-B-HRC3
Small V-type anvil	HDT-RW160-SV
Desk	HDT-DESK

MANUAL ROCKWELL HARDNESS TESTER CODE ISH-R150

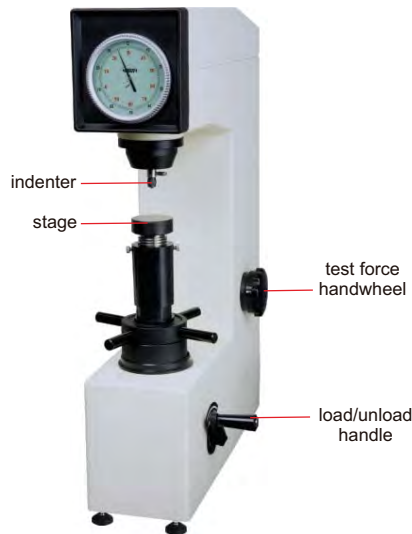

■ According to ISO 6508



Ø60mm flat anvil
(included)



Ø150mm flat anvil
(included)



V-type anvil (included)
for cylinders with
diameter Ø4~60mm



small V-type anvil
(optional)
for cylinders with
diameter Ø2~4mm



desk (optional)

SPECIFICATION

Hardness scale	HRA, HRB, HRC, HRD, HRF, HRG
Preliminary test force	98N
Test force	588N, 980N, 1471N
Display	analogue
Stage elevation	manual
Load control	manual
Min. reading	0.5HR
Max. workpiece height	170mm
Max. testing width	165mm (from the center of indenter to the wall of main body)
Dimension	520×160×700mm
Weight	60kg

STANDARD DELIVERY

Main unit	1 pc
Ø60mm flat anvil	1 pc
Ø150mm flat anvil	1 pc
V-type anvil	1 pc
Diamond indenter	1 pc
Ø1.5875mm carbide ball indenter	1 pc
Hardness test block HRB88~95	1 pc
Hardness test block HRC60~65	1 pc
Hardness test block HRC20~30	1 pc
Anti-dust cover	1 pc

OPTIONAL ACCESSORY

Hardness test block HRB88~100	HDT-B-HRB
Hardness test block HRC60~70	HDT-B-HRC3
Hardness test block HRC20~30	HDT-B-HRC1
Small V-type anvil	ISH-SMALLANVIL
Desk	HDT-DESK

MANUAL ROCKWELL HARDNESS TESTER (BASIC TYPE) CODE HDT-RW160

**POPULAR
MODEL**



■ According to ISO 6508



Ø58mm flat anvil (included)



Ø150mm flat anvil (included)



V-type anvil (included) for cylinders with diameter Ø4~60mm



level (included)



small V-type anvil (optional) for cylinders with diameter Ø2~4mm



desk (optional)

SPECIFICATION

Hardness scale	HRA, HRB, HRC, HRD, HRF, HRG
Preliminary test force	98N (10kg)
Test force	588N (60kg), 980N (100kg), 1471N (150kg)
Display	analogue
Stage elevation	manual
Load control	manual
Min. reading	0.5HR
Max. workpiece height	170mm
Max. testing width	135mm (from the center of indenter to the wall of main body)
Dimension	466×238×630mm
Weight	70kg

STANDARD DELIVERY

Main unit	1 pc
Ø58mm flat anvil	1 pc
Ø150mm flat anvil	1 pc
V-type anvil	1 pc
Diamond indenter	1 pc
Ø1.5875mm steel ball indenter	1 pc
Ø1.5875mm steel ball	5 pcs
Level	1 pc
Hardness test block HRA80~88	1 pc
Hardness test block HRB85~95	1 pc
Hardness test block HRC20~30	1 pc
Hardness test block HRC35~55	1 pc
Hardness test block HRC60~70	1 pc
Anti-dust cover	1 pc

OPTIONAL ACCESSORY

Hardness test block HRA80~84	HDT-B-HRA
Hardness test block HRB88~100	HDT-B-HRB
Hardness test block HRC20~30	HDT-B-HRC1
Hardness test block HRC35~55	HDT-B-HRC2
Hardness test block HRC60~70	HDT-B-HRC3
Small V-type anvil	HDT-RW160-SV
Desk	HDT-DESK

MANUAL ROCKWELL AND SUPERFICIAL ROCKWELL HARDNESS TESTER CODE HDT-RSR100

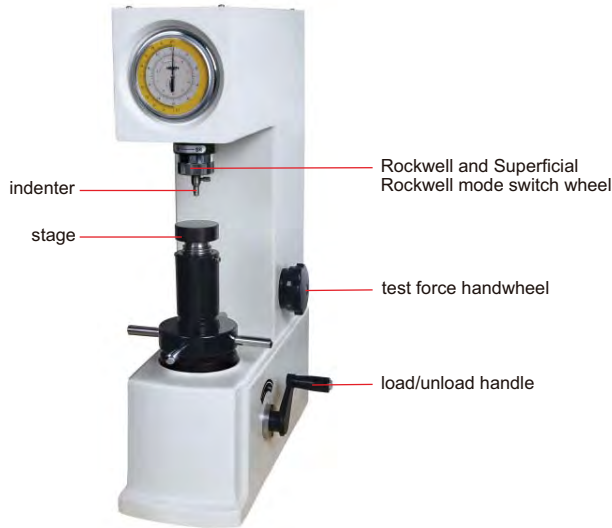

Ø60mm flat anvil (included)



Ø150mm flat anvil (included)



V-type anvil (included) for cylinders with diameter Ø4~60mm



small V-type anvil (optional) for cylinders with diameter Ø2~4mm



desk (optional)

■ According to ISO 6508

SPECIFICATION

Hardness scale	HRA, HRB, HRC, HRD, HRF, HRG, HR15N, HR30N, HR45N, HR15T, HR30T, HR45T
Preliminary test force	29.4N/3kgf for Superficial Rockwell 98N/10kgf for Rockwell
Test force	147N/15kgf, 294N/30kgf, 441N/45kgf, 588N/60kgf, 980N/100kgf, 1471N/150kgf
Display	analogue
Stage elevation	manual
Load control	manual
Min. reading	0.5HR
Max. workpiece height	160mm
Max. testing width	140mm (from the center of indenter to the wall of main body)
Dimension	460×240×660mm
Weight	75kg

STANDARD DELIVERY

Main unit	1 pc
Ø60mm flat anvil	1 pc
Ø150mm flat anvil	1 pc
V-type anvil	1 pc
Diamond indenter	1 pc
Ø1.5875mm carbide ball indenter	1 pc
Hardness test block HRB88~95	1 pc
Hardness test block HRC60~65	1 pc
Hardness test block HRC20~30	1 pc
Hardness test block 78~88HR15N	1 pc
Hardness test block 55~73HR30N	1 pc
Hardness test block 57~69HR30T	1 pc
Anti-dust cover	1 pc

OPTIONAL ACCESSORY

Hardness test block HRB88~100	HDT-B-HRB
Hardness test block HRC60~70	HDT-B-HRC3
Hardness test block HRC20~30	HDT-B-HRC1
Hardness test block 78~88HR15N	HDT-B-HR15N2
Hardness test block 55~73HR30N	HDT-B-HR30N2
Hardness test block 57~69HR30T	HDT-B-HR30T
Small V-type anvil	ISH-SMALLANVIL
Desk	HDT-DESK

DIGITAL MICRO-VICKERS HARDNESS TESTER (ADVANCED TYPE) CODE ISH-TDV1000A

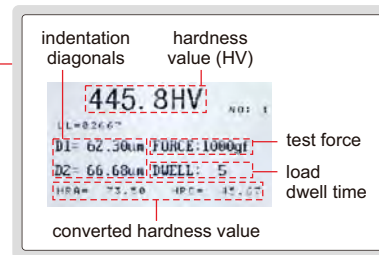
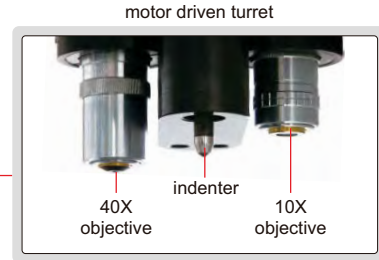

- Measure hardness of thin or small workpieces
- Based on Vickers (HV), can be converted to Rockwell (HRA, HRB and HRC)
- According to ISO 6507



cylinder holder (included)



vice (included)



slice holder (included)

SPECIFICATION

Test force	0.01, 0.025, 0.05, 0.1, 0.2, 0.3, 0.5, 1kgf
Vickers scales	HV0.01, HV0.025, HV0.05, HV0.1, HV0.2, HV0.3, HV0.5, HV1
Stage elevation	manual
Load control	automatic (load/dwell/unload)
Load dwell time	5~60 second (5 second increment)
Objective	10X, 40X
Eyepiece	15X
Total magnification	150X (for observation) 600X (for measurement)
Max. workpiece height	85mm
Max. testing width	85mm (from the center of indenter to the wall of main body)
X-Y stage	dimensions: 100×100mm
	travel range: 25×25mm
	graduation: 0.01mm
Data output	RS232C
Power supply	110/220V, 50Hz
Dimension	540x500x640mm
Weight	50kg

STANDARD DELIVERY

Main unit	1 pc
10X, 40X objective	1 pc of each
Micro Vickers indenter	1 pc
Hardness test block 400~500HV0.2	1 pc
Hardness test block 700~800HV1	1 pc
Slice holder	1 pc
Vice	1 pc
Cylinder holder	1 pc
Level	1 pc
Anti-dust cover	1 pc

OPTIONAL ACCESSORY

20X objective	ISH-TDV-20X
Hardness test block 400~500HV0.2	HDT-B-HV02C
Hardness test block 700~750HV1	HDT-B-HV1F
Measuring system	9631-130
Camera adapter	ISH-TDV-ADAPTER

VICKERS HARDNESS MEASURING SYSTEM CODE 9631-130

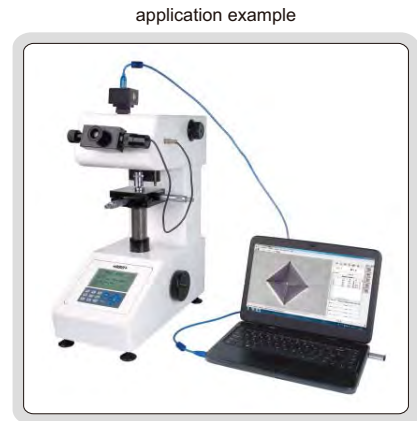

- Suitable for **ISH-TDV1000A**
- Connected to computer USB port
- Measure the indentation sizes automatically or manually
- Multiple measurements to have average value, max. value and min. value
- Tolerance testing
- Convert to HRA, HRB, HRC, HRD, HRE, HRF, HRG, HRK, HR15T/30T/45T, HR15N/30N/45N, HK, HV, HB, HS, HSD
- Calibration with standard test block
- Measurement result can be sent to Word or Excel

software (included)

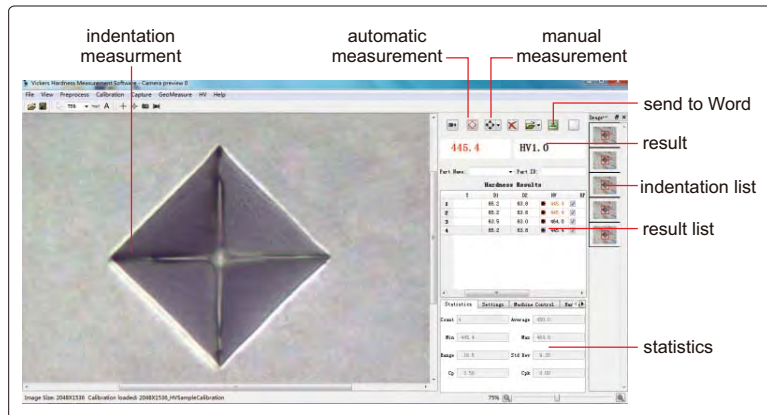

SPECIFICATION

Sensor	1/2" CMOS
Pixel	1.3M (resolution 1280×1024)
Hardness measurement resolution	0.1HV
Length measurement resolution	0.1µm
Hardness measurement accuracy	±3%
Test force	0.01, 0.025, 0.05, 0.1, 0.2, 0.3, 0.5, 1, 2, 2.5, 3, 5, 10, 20, 30, 50, 100kgf
Dimension	57×51×49mm
Weight	200g

STANDARD DELIVERY

Main unit	1 pc
USB dongle	1 pc
Software and USB cable	1 pc

TOUCH SCREEN

MOTOR DRIVEN TURRET

DIGITAL MICRO-VICKERS HARDNESS TESTER (BASIC TYPE) CODE HDT-MVH1100



LCD touch screen

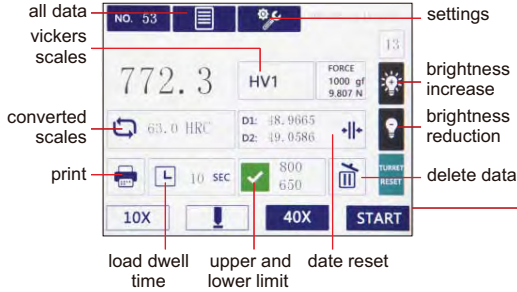

- Touch screen color LCD display
- Data storage and average value calculation
- Automatic switch between the indenter and objective lens
- According to ISO 6507



camera and measuring system



SPECIFICATION

Test force	0.098N (10gf), 0.245N (25gf), 0.49N (50gf), 0.98N (100gf), 1.96N (200gf), 2.94N (300gf), 4.9N (500gf), 9.8N (1kgf)
Vickers scales	HV0.01, HV0.025, HV0.05, HV0.1, HV0.2, HV0.3, HV0.5, HV1
Converted scales	HRA, HRB, HRC, HRD, HRF, HV, HK, HBW, HR15N, HR30N, HR45N, HR15T, HR30T, HR45T
Range	5~3000HV
Length measurement resolution	0.025µm
Objective/indenter switch	motor driven turret
Stage lifting	manual
Load control	automatic (load/dwell/unload)
Load dwell time	1~60 second
Objective	10X, 40X
Eyepiece	10X
Total magnification	10X (for measurement or observation), 400X (for measurement)
Max. workpiece height	90mm
Max. testing width	95mm (from the center of indenter to the wall of main body)
X-Y stage	dimensions: 100×100mm, travel range: 25×25mm
Data output	built-in printer
Power supply	220V, 50/60Hz
Dimension	510×290×570mm
Weight	40kg

STANDARD DELIVERY

Main unit	1 pc
10X, 40X objective	1 pc of each
Micro vickers indenter	1 pc
Hardness test block 400~500HV0.2	1 pc
Hardness test block 700~750HV1	1 pc
Slice holder	1 pc
Vice	1 pc
Cylinder holder	1 pc
Anti-dust cover	1 pc

OPTIONAL ACCESSORY

Hardness test block 400~500HV0.2	HDT-B-HV02C
Hardness test block 700~750HV1	HDT-B-HV1F
Camera	HDT-MVH-CM
Measuring system	HDT-MVH-SW

DIGITAL MICRO-VICKERS HARDNESS TESTERS



motor driven turret

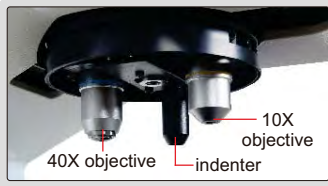

- Measure hardness of thin or small workpieces
- Converted to HRA, HRB, HRC, HRD, HRF, HV, HK, HBW, HR15N, HR30N, HR45N, HR15T, HR30T, HR45T
- Motor driven turret to switch between indenter and objective lens automatically
- Calibrated according to standard hardness blocks or length scales
- Test result can be sent to Word or Excel
- According to ISO 6507

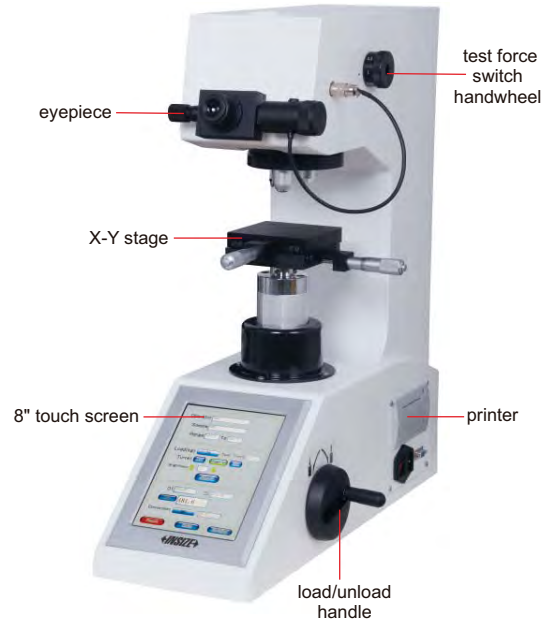

HDT-MV290

SPECIFICATION

Code	HDT-MV290	HDT-MV290S
Test force	manual switch of test force	motorized switch of test force
Vickers scales	0.098N (10gf), 0.245N (25gf), 0.49N (50gf), 0.98N (100gf), 1.96N (200gf), 2.94N (300gf), 4.9N (500gf), 9.8N (1kgf)	
Range	HV0.01, HV0.025, HV0.05, HV0.1, HV0.2, HV0.3, HV0.5, HV1	
Length measurement resolution	0.01µm	
Objective/indenter switch	motor driven turret	
Stage lifting	manual	
Load control	automatic (load/dwell/unload)	
Load dwell time	1~99 second	
Objective	10X, 40X	
Eyepiece	10X	
Total magnification	100X (for measurement or observation), 400X (for measurement)	
Max. workpiece height	100mm	
Max. testing width	130mm (from the center of indenter to the wall of main body)	
X-Y stage	dimensions: 100×100mm, travel range: 25×25mm	
Data output	built-in printer, RS232	
Power supply	220V, 50/60Hz	
Dimension	540×260×650mm	
Weight	50kg	



vice (included)



slice holder (included)



cylinder holder (included)

STANDARD DELIVERY

Main unit	1 pc
10X, 40X objective	1 pc of each
Micro vickers indenter	1 pc
Hardness test block 400~500HV0.2	1 pc
Hardness test block 700~750HV1	1 pc
Level	1 pc
Touch pen	1 pc
Slice holder	1 pc
Vice	1 pc
Cylinder holder	1 pc
Anti-dust cover	1 pc

OPTIONAL ACCESSORY

Hardness test block 400~500HV0.2	HDT-B-HV02C
Hardness test block 700~750HV1	HDT-B-HV1F
Measuring system	HDT-VS530



DIGITAL DUAL-INDENTER MICRO-VICKERS HARDNESS TESTERS

motor driven turret

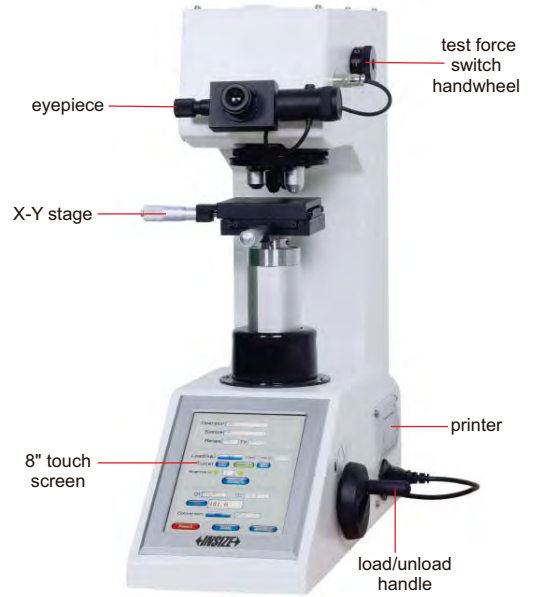
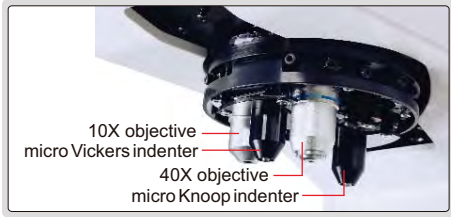

HDT-MV280

- With Vickers indenter and Knoop indenter
- Micro Vickers indenter is for thin and small workpieces, carburizing layers, hardening layers and coating
- Knoop indenter is for hard and brittle materials, such as enamel, glass, synthetic diamond, cermet and minerals
- Converted to HRA, HRB, HRC, HRD, HRF, HV, HK, HBW, HR15N, HR30N, HR45N, HR15T, HR30T, HR45T
- Motor driven turret to switch indenters and objective lens automatically
- Calibrated according to standard hardness blocks or length scales
- Test result can be sent to Word or Excel
- According to ISO 6507

SPECIFICATION

Code	HDT-MV280	HDT-MV280S
Test force	manual switch of test force	motorized switch of test force
Vickers scales	0.098N (10gf), 0.245N (25gf), 0.49N (50gf), 0.98N (100gf), 1.96N (200gf), 2.94N (300gf), 4.9N (500gf), 9.8N (1kgf)	
Knoop scales	HV0.01, HV0.025, HV0.05, HV0.1, HV0.2, HV0.3, HV0.5, HV1	
Range	HK0.01, HK0.025, HK0.05, HK0.1, HK0.2, HK0.3, HK0.5, HK1	
Length measurement resolution	8~2900HV/HK	
Objective/indenter switch	0.01µm	
Stage lifting	motor driven turret	
Load control	manual	
Load dwell time	automatic (load/dwell/unload)	
Objective	1~99 second	
Eye-piece	10X, 40X (optional 20X, 50X, 60X)	
Total magnification	10X	
Max. workpiece height	100X (for measurement or observation), 400X (for measurement)	
Max. testing width	100mm	
X-Y stage	130mm (from the center of indenter to the wall of main body)	
Data output	dimension: 100×100mm, travel range: 25×25mm	
Power supply	built-in printer, RS232	
Dimension	220V, 50/60Hz	
Weight	540×260×650mm	
	50kg	



vice (included)



cylinder holder (included)



slice holder (included)

STANDARD DELIVERY

Main unit	1 pc
10X, 40X objective	1 pc of each
Micro vickers indenter	1 pc
Knoop indenter	1 pc
Hardness test block 400~500HV0.2	1 pc
Hardness test block 700~750HV1	1 pc
Hardness test block 700~800HK1	1 pc
Level	1 pc
Touch pen	1 pc
Vice	1 pc
Slice holder	1 pc
Cylinder holder	1 pc
Anti-dust cover	1 pc

OPTIONAL ACCESSORY

Hardness test block 400~500HV0.2	HDT-B-HV02C
Hardness test block 700~750HV1	HDT-B-HV1F
Hardness test block 700~800HK1	HDT-B-HK1C
Measuring system	HDT-VS530

AUTOMATIC MICRO-VICKERS HARDNESS TESTER CODE HDT-VS1D

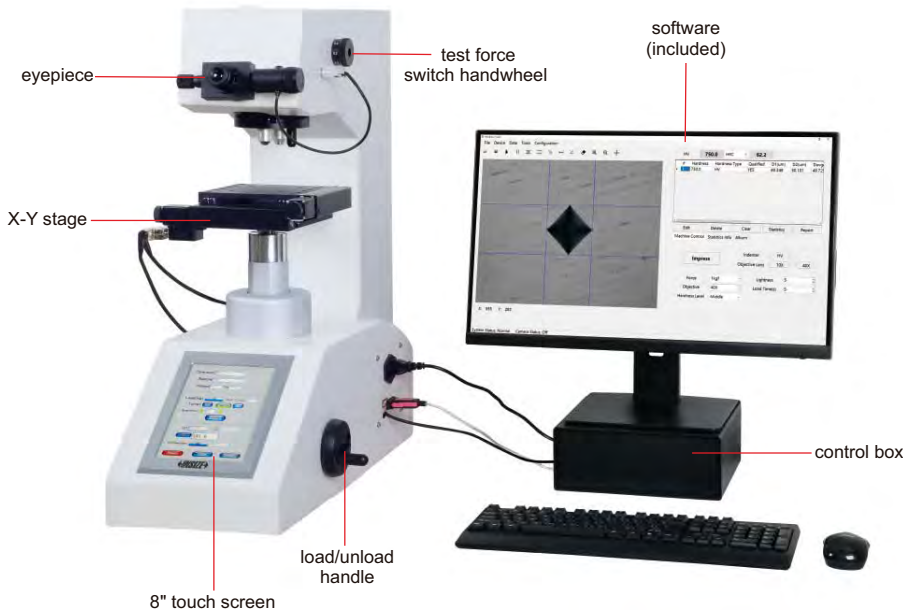

vice (included)



slice holder (included)



cylinder holder (included)

- Detect depth of hardened layer of heat treatment and coating thickness. Can also be used for metallography observation
- Calibrate according to standard hardness blocks or length scales
- Convert to HRA, HRB, HRC, HRD, HRF, HV, HBW, HR15N, HR30N, HR45N, HR15T, HR30T, HR45T
- Built-in printer
- According to ISO 6507

X-Y stage



motor driven turret

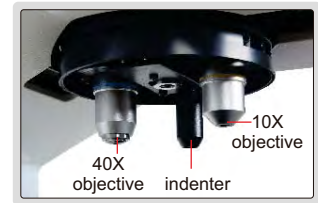

result and conversion

measuring list

#	Hardness	Hardness Type	Qualified	D1(um)	D2(um)	Dang
1	750.0	HV	YES	49.349	50.101	49.72

report

machine control

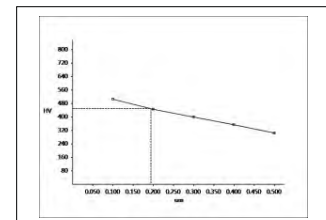

depth of hardened layer

To be continued



Continued from previous page

SPECIFICATION

Test force	0.098N (10gf), 0.245N (25gf), 0.49N (50gf), 0.98N (100gf), 1.96N (200gf), 2.94N (300gf), 4.9N (500gf), 9.8N (1kgf)	
Vickers scales	HV0.01, HV0.025, HV0.05, HV0.1, HV0.2, HV0.3, HV0.5, HV1	
Range	8HV~2900HV	
Length measurement resolution	0.01µm	
Objective/indenter switch	motor driven turret	
Stage lifting	manual	
Load control	automatic (load/dwell/unload)	
Load dwell time	1~99 second	
Objective	10X, 40X	
Eyepiece	10X	
Total magnification	100X (for measurement or observation), 400X (for measurement)	
Data output	built-in printer	
Max. workpiece height	160mm	
Max. testing width	160mm (from the center of indenter to the wall of main body)	
X-Y stage	dimensions: 150×150mm, travel range: 50×50mm, graduation: 1µm, displacement repeatability: 3µm	
Pixel	5M	
Measurement and control software	stage movement control	select points for indenter to press then read 1. select any point 2. rotate and select a point 3. select points along X-axis 4. select points along Y-axis 5. select points along Z 6. select points at any internal 7. program selection of points
	measurement	automatic mode: automatic turret, automatic loading, automatic measurement control can also select manual mode
Power supply	220V, 50/60Hz	
Dimension	620×250×710mm	
Weight	50kg	

STANDARD DELIVERY

Main unit	1 pc
10X, 40X objective	1 pc of each
Micro vickers indenter	1 pc
Hardness test block 400~500HV0.2	1 pc
Hardness test block 700~750HV1	1 pc
Level	1 pc
Touch pen	1 pc
Anti-dust cover	1 pc
Control box	1 pc
Software and USB dongle	1 pc of each
Computer	1 pc
Slice holder	1 pc
Vice	1 pc
Cylinder holder	1 pc

OPTIONAL ACCESSORY

Hardness test block 400~500HV0.2	HDT-B-HV02C
Hardness test block 700~750HV1	HDT-B-HV1F
OFFICE software	7313-OFFICE
Knoop indenter	HDT-VS1D-KNOOP

DIGITAL VICKERS HARDNESS TESTERS

FORCE LOADING BY ELECTRIC MOTOR (WITHOUT WEIGHTS)

INSPECTION CERTIFICATE



- LCD touch screen, easy operation
- Insert USB flash disk, save the test results as Excel
- Converted to HRA, HRB, HRC, HRD, HRF, HV, HK, HBW, HR15N, HR30N, HR45N, HR15T, HR30T, HR45T
- Force loading by electric motor, without weights
- According to ISO 6507

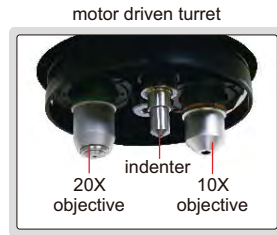

HDT-VD50A



Ø58mm flat anvil (included)



Ø150mm flat anvil (included)



V-type anvil (included)



level (included)

SPECIFICATION

Code	HDT-VD10A	HDT-VD30A	HDT-VD50A	HDT-VD100A	HDT-VD120A
Test force	0.3, 0.5, 1, 2, 2.5, 3, 5, 10kgf	0.3, 0.5, 1, 2, 2.5, 3, 5, 10, 15, 20, 30kgf	0.5, 1, 2, 2.5, 3, 5, 10, 15, 20, 30, 40, 50kgf	2, 3, 5, 10, 20, 30, 50, 60, 80, 100kgf	5, 10, 20, 30, 50, 100, 120kgf
Range	8~2900HV				
Load control	automatic (load/dwell/unload)				
Load dwell time	1~99 second				
Eyepiece	10X				
Objective	10X, 20X (optional 2.5X, 5X, 40X)				
Total magnification	100X, 200X (optional 25X, 50X, 400X)				
Length measurement resolution	0.01µm				
Data output	USB flash disk				
Max. workpiece height	180mm				
Max. testing width	160mm (from the center of indenter to the wall of main body)				
Power supply	220V, 50/60Hz				
Dimension	580x190x700mm				
Weight	55kg				

STANDARD DELIVERY

Main unit	1 pc
10X, 20X objective	1 pc of each
Vickers indenter	1 pc
Ø58mm flat anvil	1 pc
Ø150mm flat anvil	1 pc
V-type anvil	1 pc
Hardness test block	2 pcs
USB flash disk	1 pc
Level	1 pc
Touch pen	1 pc
Anti-dust cover	1 pc

OPTIONAL ACCESSORY

Hardness test block	page 747~748
2.5X objective	HDT-VD-OB2X
5X objective	HDT-VD-OB5X
40X objective	HDT-VD-OB40X
Vickers hardness measuring system	HDT-VS530

VICKERS HARDNESS MEASURING SYSTEM CODE HDT-VS530

measure the indentation sizes automatically or manually, and hardness tester can be controlled by software



C-mount



software flash disk (included)



camera adapter (included)

- Suitable for digital Vickers hardness tester **HDT-VD** series and **HDT-MV** series
- Connected to computer USB port
- Measure the indentation sizes automatically or manually
- Multiple measurements to have average value, max. value, min. value and variance
- Convert to HRA, HRB, HRC, HRD, HRF, HV, HK, HBW, HR15N, HR30N, HR45N, HR15T, HR30T, HR45T
- Hardness tester can be controlled by software
- Measurement result can be sent to Word, Excel or CSV

measuring software (included)

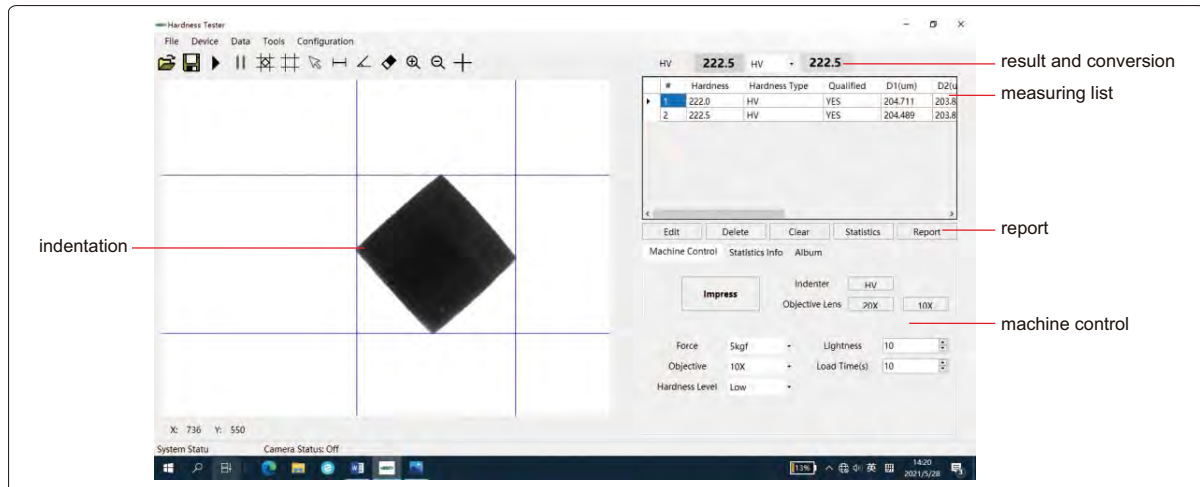

SPECIFICATION

Sensor	1/2.5" CMOS
Pixel	5M (resolution 2592×1944)
Hardness measurement resolution	0.1HV
Length measurement resolution	0.001µm
Test force	0.3, 0.5, 1, 2, 2.5, 3, 5, 10, 15, 20, 30, 40, 50, 60, 80, 100, 120kgf
Dimension	30×30×40mm
Weight	50g

STANDARD DELIVERY

Main unit	1 pc
Software and USB cable	1 pc
RS232 cable	1 pc
Camera adapter	1 set

AUTOMATIC DIGITAL BRINELL HARDNESS TESTER CODE HDT-XB500

TEST FORCE LOADING BY ELECTRIC
MOTOR (WITHOUT WEIGHT)



automatic test



Press the "test" button on the screen to start testing. The stage ascends automatically until the workpiece touches the indenter. Automatically load, dwell and unload. The turret rotates and the objective focuses automatically. Measure the indentation by measuring microscope or automatic measuring system.



Ø200mm flat anvil
(included)



Ø80mm flat anvil
(included)



V-type anvil (included)



touch pen (included)

- Automatic testing
- LCD touch screen, easy operation
- Measure indentation by measuring microscope or automatic measuring system
- Tolerance testing
- Insert USB flash disk, save the test results as Excel
- Force loading by electric motor, without weights
- According to ISO 6506

SPECIFICATION

Turret rotation	automatic	
Stage elevation	automatic	
Range	8~650HBW	
Test force	62.5, 100, 125, 187.5, 250, 500, 750, 1000, 1500, 3000kgf	
Measuring Accuracy	HBW≤125	±3%
	125<HBW≤225	±2.5%
	HBW>225	±2%
Hardness measuring resolution	0.1HBW	
Measuring microscope	eyepiece	20X
	resolution	0.1µm
Load control	automatic (load/dwell/unload)	
Load dwell time	0~99 second	
Max. workpiece height	400mm	
Max. testing width	250mm (from the center of indenter to the wall of main body)	
Power supply	220V, 50/60Hz	
Dimension	700×340×970mm	
Weight	160kg	



HDT-XB500

STANDARD DELIVERY

Main unit	1 pc
Measuring microscope	1 pc
Automatic measuring system	1 pc
Ø80mm flat anvil	1 pc
Ø200mm flat anvil	1 pc
V-type anvil	1 pc
Ø2.5mm carbide ball indenter	1 pc
Ø5mm carbide ball indenter	1 pc
Ø10mm carbide ball indenter	1 pc
Hardness test block 150~250HBW2.5/187.5	1 pc
Hardness test block 75~125HBW10/1000	1 pc
Hardness test block 175~250HBW10/3000	1 pc
USB flash disk (8G)	1 pc
Touch pen	1 pc
Anti-dust cover	1 pc

OPTIONAL ACCESSORY

10X eyepiece	HDT-XB500-EP10X
15X eyepiece	HDT-XB500-EP15X
Hardness test block	page 747~748
Desk	HDT-DESK

**AUTOMATIC TESTING,
AUTOMATIC TEST FORCE LOADING**

**FORCE LOADING BY ELECTRIC
MOTOR (WITHOUT WEIGHT)**



MOTORIZED DIGITAL BRINELL HARDNESS TESTERS

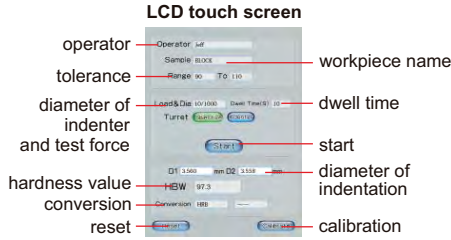

- Automatic testing, automatic test force loading
- LCD touch screen, easy operation
- Measure indentation by measuring microscope then read the hardness value from LCD
- Tolerance testing
- Insert USB flash disk, save the test results as Excel
- Converted to HRA, HRB, HRC, HRD, HRF, HV, HB, HR15N, HR30N, HR45N, HR15T, HR30T, HR45T
- Force loading by electric motor, without weights
- According to ISO 6506



ISHB-D200

step: 1



elevate the stage by hand to let the indenter approach the workpiece, press "start" to start testing automatically, the test force is loaded automatically

step: 2



measuring microscope

measure indentation with measuring microscope

step: 3



read the hardness value from LCD



SPECIFICATION

Code	ISHB-D200	ISHB-D300
Turret rotation	manual	automatic
Range	8~650HBW	
Reading mode	directly read from LCD	
Test force	62.5, 100, 125, 187.5, 250, 500, 750, 1000, 1500, 3000kgf	
Max. workpiece height	200mm	
Max. testing width	155mm (from the center of indenter to the wall of main body)	
Stage elevation	manual	
Load control	automatic (load/dwell/unload)	
Load dwell time	5~60 second	
Measuring microscope	magnification	20X
	resolution	0.625µm
Power supply	220V, 50/60Hz	
Dimension	550x210x750mm	
Weight	110kg	

STANDARD DELIVERY

Main unit	1 pc
Ø80mm flat anvil	1 pc
Ø200mm flat anvil	1 pc
V-type anvil	1 pc
Ø2.5mm carbide ball indenter	1 pc
Ø5mm carbide ball indenter	1 pc
Ø10mm carbide ball indenter	1 pc
Hardness test block 150~250HBW2.5/187.5	1 pc
Hardness test block 75~125HBW10/1000	1 pc
Hardness test block 175~250HBW10/3000	1 pc
USB flash disk (8G)	1 pc
Touch pen	1 pc
Anti-dust cover	1 pc

OPTIONAL ACCESSORY

Hardness test block 200~300HBW2.5/187.5	HDT-B-HB25A2
Hardness test block 90~200HBW10/1000	HDT-B-HB10C1
Hardness test block 200~300HBW10/3000	HDT-B-HB10A2
Brinell indentation measuring system	ISHB-MSA
Desk	HDT-DESK

MOTORIZED BRINELL HARDNESS TESTER CODE ISHB-M100

FORCE LOADING BY ELECTRIC MOTOR (WITHOUT WEIGHTS)

AUTOMATIC TESTING AFTER PRELIMINARY TEST FORCE IS LOADED BY HAND

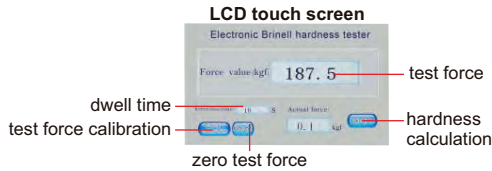

step: 1

measure indentation diameter by measuring microscope

step: 2

input the diameters, the hardness value is shown on screen automatically

- LCD touch screen, easy operation
- Automatic testing after preliminary test force is loaded by hand
- Measure indentation diameter by measuring microscope, input the diameters, the hardness value is shown on screen automatically
- Force loading by electric motor, without weights
- According to ISO 6506



Ø80mm flat anvil (included)



Ø200mm flat anvil (included)



V-type anvil (included)



measuring microscope (included)



desk (optional)

SPECIFICATION

Range	8~650HBW	
Reading mode	directly read from LCD	
Test force	62.5, 100, 125, 187.5, 250, 500, 750, 1000, 1500, 3000kgf	
Max. workpiece height	230mm	
Max. testing width	160mm (from the center of indenter to the wall of main body)	
Stage elevation	manual	
Load control	automatic (load/dwell/unload)	
Load dwell time	5~60 second	
Measuring microscope	magnification	20X
	graduation	0.01mm
Power supply	220V, 50/60Hz	
Dimension	550×210×750mm	
Weight	90kg	

STANDARD DELIVERY

Main unit	1 pc
Ø80mm flat anvil	1 pc
Ø200mm flat anvil	1 pc
V-type anvil	1 pc
Ø2.5mm carbide ball indenter	1 pc
Ø5mm carbide ball indenter	1 pc
Ø10mm carbide ball indenter	1 pc
Hardness test block 150~250HBW2.5/187.5	1 pc
Hardness test block 75~125HBW10/1000	1 pc
Hardness test block 175~250HBW10/3000	1 pc
Measuring microscope	1 pc
Anti-dust cover	1 pc

OPTIONAL ACCESSORY

Hardness test block 200~300HBW2.5/187.5	HDT-B-HB25A2
Hardness test block 90~200HBW10/1000	HDT-B-HB10C1
Hardness test block 200~300HBW10/3000	HDT-B-HB10A2
Brinell indentation measuring system	ISHB-MSA
Desk	HDT-DESK

BRINELL INDENTATION MEASURING SYSTEM CODE ISHB-MSA

application



software flash disk
(included)

software (included)

- Connected to computer USB port
- Automatically measure the indentation
- Result saved to Excel automatically
- Tolerance testing
- Calibration with standard hardness blocks or standard indentation blocks

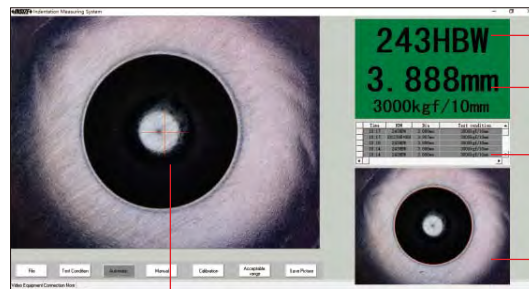

- result and scale
- diameter of indentation
- result list
- picture

indentation

SPECIFICATION

Applicable Brinell indenter	Ø10mm, Ø7.26mm, Ø5mm, Ø4mm, Ø2.5mm	
Hardness range	16~650HB	
Range of indentation diameter	Ø0.6~6mm	
Test force	62.5, 100, 125, 187.5, 250, 500, 750, 1000, 1500, 3000kgf	
Hardness resolution	1HB	
Diameter measuring resolution	0.001mm	
Diameter measuring accuracy	Ø10mm ball indenter	±0.4% (indentation diameter)
	Ø5mm ball indenter	±0.8% (indentation diameter)
	Ø2.5mm ball indenter	±1.2% (indentation diameter)
Camera	sensor	1/3.2" CMOS
	pixel	2M (resolution 1600×1200)
	view filed	8×6mm
Dimension	170×54×54mm	
Weight	385g	



standard blocks for Ø5mm and Ø10mm indenters (included)

STANDARD DELIVERY

Main unit	1 pc
Software	1 pc
Ø5mm standard indentation block	1 pc
Ø10mm standard indentation block	1 pc

OPTIONAL ACCESSORY

Ø2.5mm standard indentation block	ISHB-MSA-BLOCK25
-----------------------------------	------------------

DIGITAL BRINELL/ROCKWELL/VICKERS HARDNESS TESTER CODE HDT-BRV130

FORCE LOADING BY ELECTRIC MOTOR (WITHOUT WEIGHTS)

- According to ISO 6506, ISO 6507, ISO 6508
- Force loading by electric motor (without weights)



SPECIFICATION

Brinell test load	49N (5kgf), 98N (10kgf), 153N (15.625kgf), 294N (30kgf), 306N (31.25kgf), 613N (62.5kgf), 980N (100kgf), 1226N (125kgf), 1839N (187.5kgf)
Brinell scales	HBW1/5, HBW2.5/62.5, HBW1/10, HBW2.5/15.625, HBW1/30, HBW2.5/31.25, HBW2.5/62.5, HBW10/100, HBW5/125, HBW2.5/187.5
Brinell resolution	0.1HBW
Rockwell test load	98N (10kgf) preload 588 (60kgf), 980 (100kgf), 1471N (150kgf) total load
Rockwell scales	HRA, HRB, HRC, HRD, HRE, HRF, HRG, HRH, HRK, HRL, HRM, HRP, HRR, HRS, HRV
Rockwell resolution	0.1HR
Vickers test load	49N (5kgf), 98N (10kgf), 196N (20kgf), 294N (30kgf), 392N (40kgf), 490N (50kgf), 588N (60kgf), 784N (80kgf), 980N (100kgf), 1176N (120kgf)
Vickers scales	HV5, HV10, HV20, HV30, HV40, HV50, HV60, HV80, HV100, HV120
Vickers resolution	0.1HV
Objective	2.5X/5X
Magnification of microscope	Brinell: 37.5X, Vickers: 75X
Hardness test range	Brinell: 8~650HBW, Rockwell: 20~100HR, Vickers: 8~2900HV
Max. workpiece height	Rockwell: 220mm, Brinell and Vickers: 150mm
Max. testing width	200mm (from the center of indenter to the wall of main body)
Data output	USB flash disk
Power supply	220V, 50/60Hz
Dimension	560×350×800mm
Weight	70kg

LCD touch screen



Ø60mm flat anvil for Rockwell (included)



Ø60mm flat anvil for Vickers and Brinell (included)



V-type anvil for Rockwell (included), for cylinders with diameter Ø4~60mm



small V-type anvil for Rockwell (optional), for cylinders with diameter Ø2~4mm



Ø150mm flat anvil for Rockwell (included)



desk (optional)

STANDARD DELIVERY

Main unit	1 pc
Vickers diamond indenter	1 pc
Rockwell diamond indenter	1 pc
Ø1.5875mm Rockwell indenter	1 pc
Ø2.5mm Brinell indenter	1 pc
Ø5mm Brinell indenter	1 pc
Ø60mm flat anvil for Rockwell	1 pc
Ø150mm flat anvil for Rockwell	1 pc
V-type anvil for Rockwell	1 pc
Ø60mm flat anvil for Vickers and Brinell	1 pc
Hardness test block HRB88~95	1 pc
Hardness test block HRC60~65	1 pc
Hardness test block HRC20~30	1 pc
Hardness test block 400~500HV30	1 pc
Hardness test block 180~300HBW2.5/187.5	1 pc
Level	1 pc
USB flash disk	1 pc
Touch pen	1 pc
Anti-dust cover	1 pc

OPTIONAL ACCESSORY

Hardness test block HRB88~100	HDT-B-HRB
Hardness test block HRC60~70	HDT-B-HRC3
Hardness test block HRC20~30	HDT-B-HRC1
Hardness test block 400-500HV30	HDT-B-HV30D
Hardness test block 200-300HBW2.5/187.5	HDT-B-HB25A2
Small V-type anvil for Rockwell	ISH-SMALLANVIL
Desk	HDT-DESK



BRINELL/ROCKWELL/VICKERS HARDNESS TESTER CODE ISH-BRV



Ø60mm flat anvil for Rockwell (included)



Ø150mm flat anvil for Rockwell (included)



Ø60mm flat anvil for Vickers and Brinell (included)



V-type anvil for Rockwell (included), for cylinders with diameter Ø4~60mm

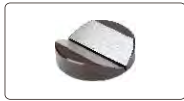

V-type anvil for Vickers and Brinell (included)



small V-type anvil for Rockwell (optional), for cylinders with diameter Ø2~4mm



desk (optional)



VIDEO

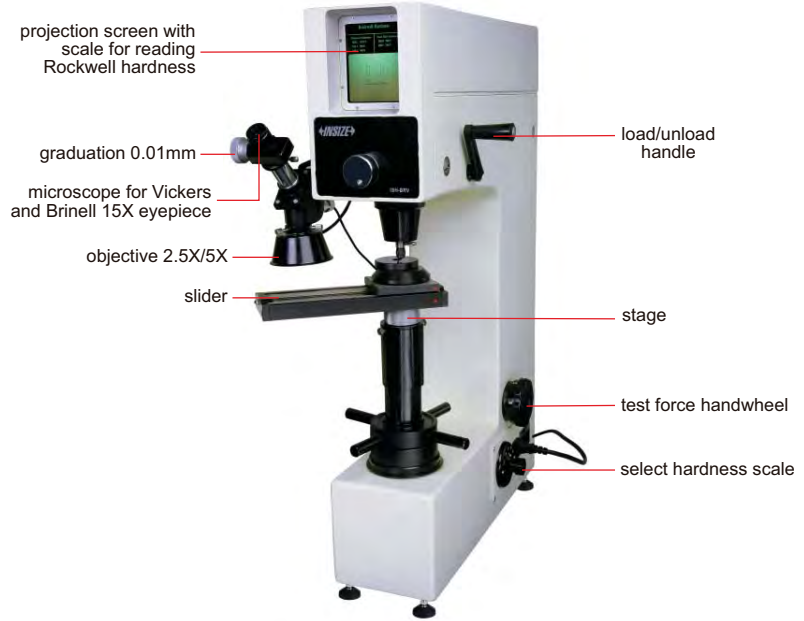

- According to ISO 6506, ISO 6507, ISO 6508

SPECIFICATION

Rockwell test load	98N preload, 588, 980, 1471N total load
Min. Rockwell reading	0.5HR
Brinell test load	306, 613, 1839N
Vickers test load	294N
Stage elevation	manual
Load control	manual
Magnification of microscope	37.5X/75X
Max. workpiece height	180mm
Max. testing width	200mm (from the center of indenter to the wall of main body)
Power supply	220V, 50/60Hz
Dimension	546×300×767mm
Weight	90kg

STANDARD DELIVERY

Main unit	1 pc
Ø1.5875mm carbide ball indenter	1 pc
Diamond Rockwell indenter	1 pc
Ø5mm Brinell indenter	1 pc
Ø2.5mm Brinell indenter	1 pc
Vickers indenter	1 pc
Ø60mm flat anvil for Rockwell	1 pc
Ø150mm flat anvil for Rockwell	1 pc
V-type anvil for Rockwell	1 pc
Ø60mm flat anvil for Vickers and Brinell	1 pc
V-type anvil for Vickers and Brinell	1 pc
Hardness test block HRB88~95	1 pc
Hardness test block HRC60~65	1 pc
Hardness test block HRC20~30	1 pc
Hardness test block 400~500HV30	1 pc
Hardness test block 180~300HBW2.5/187.5	1 pc
Anti-dust cover	1 pc

OPTIONAL ACCESSORY

Hardness test block HRB88~100	HDT-B-HRB
Hardness test block HRC60~70	HDT-B-HRC3
Hardness test block HRC20~30	HDT-B-HRC1
Hardness test block 400-500HV30	HDT-B-HV30D
Hardness test block 200-300HBW2.5/187.5	HDT-B-HB25A2
Small V-type anvil for Rockwell	ISH-SMALLANVIL
Desk	HDT-DESK

PORTABLE LEEB HARDNESS TESTER APPLICABLE MATERIAL AND HARDNESS RANGE OF IMPACT DEVICE D

Material	HLD	HV	HB	HRC	HRB	HS	Tensile strength (MPa)
Steel & cast steel	300-900	81-955	81-654	20-68	38-100	32-100	375-2639
Tool steel	300-840	80-898		20-67			
Stainless steel	300-800	85-802	85-655		46-101		
Cast iron	360-650		93-334				
Cast aluminum alloy	170-570		19-164		23-84		
Brass	200-550		40-173		13-95		
Bronze	300-700		60-290				
Copper	200-690		45-315				

PORTABLE LEEB HARDNESS TESTERS

BLUETOOTH

DATA
OUTPUT

INSPECTION
CERTIFICATE



HDT-CB320
(wired probe is included)



HDT-WL320
(wireless probe is included)

- Can use wired probes or wireless probes
- Dual-coil probe for high accuracy
- Universal testing angle, no need to set impact direction
- Based on Leeb (HLD), converted to Vickers (HV), Brinell (HB), Rockwell (HRC, HRA and HRB), Shore (HS) and tensile strength (σb)
- Dual value display, shows both Leeb and converted hardness
- Large 2.4" LCD display with backlight
- With a magnet on the back, the main unit can be attached on steel surfaces
- According to ASTM A956 and DIN 50156



hardness test
block D (included)



small support ring
(included)

connect to PC, upload the data to PC, print and send to Excel (software is included)



connect to
bluetooth printer (optional)



To be continued

Continued from previous page

SPECIFICATION

Code	HDT-CB320	HDT-WL320
Probe included	wired probe D	wireless probe D
Optional probes	wired (DC/C/D/D+15/DL/E/G), wireless (DC/C/D/DL/G)	
Resolution	1HLD/1HV/1HB/0.1HRC/0.1HRB/0.1HRA/0.1HS/1MPa	
Accuracy	±6HLD (when HLD=800)	
Output	USB	
Measuring range	HL 170-960/HRC 1.3-74.7/HRB 1.2-139.7/HB 28-1027/HV 45-1221 HS 4.0-112.1/HRA 1.3-88.5/MPa 118-3315N/mm ²	
Applicable materials	1. steel/cast steel 2. alloy steel 3. stainless steel 4. gray pig iron 5. nodular cast iron 6. cast aluminum 7. brass 8. bronze 9. copper 10. forging steel 11. rolling steel	
Statistics	average/max./min./s.value	
Memory	999 data	
Working environment	-10°C~45°C	
Power supply	2xAA battery	
Dimension	145×68×28mm	
Weight	158g	

STANDARD DELIVERY

Code	HDT-CB320	HDT-WL320
Main unit	1 pc	1 pc
Wired probe D	1 pc	—
Wireless probe D	—	1 pc
Hardness test block D	1 pc	1 pc
Small support ring	1 pc	1 pc
Cleaning brush	1 pc	1 pc

OPTIONAL ACCESSORY

Wired probe	DC	HDT-CB320-DC
	C	HDT-CB320-C
	D	HDT-CB320-D
	D+15	HDT-CB320-D15
	DL	HDT-CB320-DL
	E	HDT-CB320-E
	G	HDT-CB320-G
Wireless probe	DC	HDT-WL320-DCW
	C	HDT-WL320-CW
	D	HDT-WL320-DW
	DL	HDT-WL320-DLW
	G	HDT-WL320-GW
Hardness test block D **		HDT-B-HLD3
Hardness test block G *		HDT-B-HLG2
Printer		ISH-LP200-PRINTER
Support rings		page 738

* Hardness test block G (HDT-B-HLG2) is for probe G (HDT-LP320-G or HDT-LP320-GW)
 ** Hardness test block D (HDT-B-HLD3) is for all other probes

wired probes (optional)

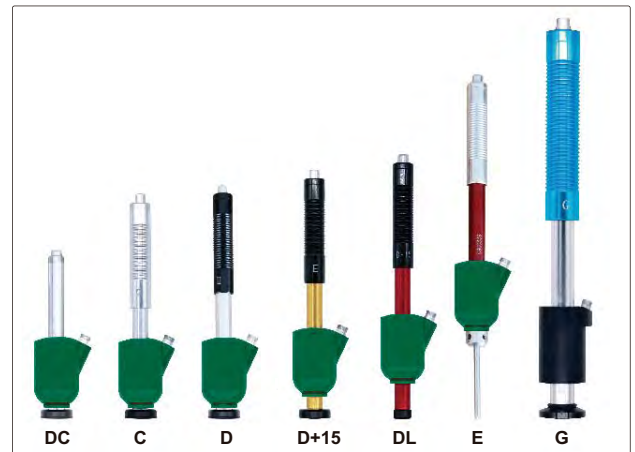

wireless probes (optional)

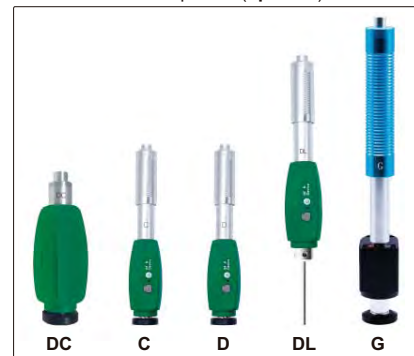

APPLICABLE WORKPIECE

Probes	DC	C	D	D+15	DL	E	G
Application	inner wall of small space	small or thin workpiece, coating layer	general use	deep groove	narrow slot or small hole	very hard material	casting or forging workpiece
Maximum roughness of workpiece (Ra)	2µm	0.4µm	2µm	2µm	2µm	2µm	7µm
Minimum weight of workpiece	direct measurement	5kg	1.5kg	5kg	5kg	5kg	15kg
	on solid support	2.5kg	0.5kg	2kg	2kg	2kg	5kg
	coupled on plate	0.05-2kg	0.02kg	0.05-2kg	0.1kg	0.1kg	0.5kg
Minimum thickness of workpiece	3mm	1mm	3mm	3mm	3mm	3mm	10mm

PORTABLE LEEB HARDNESS TESTER CODE ISH-PHB



- Based on Leeb (HLD), converted to Vickers (HV), Brinell (HB), Rockwell (HRC and HRB), Shore (HS) and tensile strength (MPa)
- Memory of 99 measurement values for browsing
- Set measurement times (1-9) to have average value
- Connected with printer via bluetooth
- Automatic power off, according to ASTM A 956



hardness test block D (included)



small support ring (included)



wireless printer (optional)

SPECIFICATION

Min. reading	1HLD, 1HV, 1HB, 0.1HRC, 0.1HRB, 1HS, 1MPa	
Accuracy	±6HLD (when HLD=800)	
Display	Leeb (HLD), converted hardness, material, impact direction, test times, average value, date	
Output	bluetooth	
Applicable workpiece	minimum weight	5kg
		2kg (on solid support)
		0.1kg (coupled on plate)
	minimum thickness: 5mm	
minimum radius of curved surface: 30mm		
maximum roughness (Ra): 1.6µm		
Power supply	3×AAA batteries	
Dimension	150×84×28mm	
Weight	200g	

STANDARD DELIVERY

Main unit	1 pc
Impact device D	1 pc
Hardness test block D	1 pc
Small support ring	1 pc
Cleaning brush	1 pc

OPTIONAL ACCESSORY

Wireless printer	ISH-DS-PRINTER
Couplant	ISH-COUPPLANT
Support rings	page 738
Hardness test block D	HDT-B-HLD3

BUILT-IN BLUETOOTH

DATA OUTPUT

PORTABLE LEEB HARDNESS TESTER (BUILT-IN BLUETOOTH) CODE ISH-PHB-B

**INSPECTION
CERTIFICATE**

- Based on Leeb (HLD), converted to Vickers (HV), Brinell (HB), Rockwell (HRC and HRB), Shore (HS) and tensile strength (MPa)
- Memory of 99 measurement values for browsing
- Set measurement times (1-9) to have average value
- Connected with printer via wireless module
- Automatic power off
- According to ASTM A 956
- Wired data transmission (keyboard signal):
USB cable connect to computer, press transmission button to send data
- Wireless data transmission (keyboard signal):
built-in Bluetooth module connect to computer or mobile phone, press transmission button to send data



transmission button



hardness test block D (included)



small support ring (included)



wireless printer (optional)



VIDEO

SPECIFICATION

Min. reading	1HLD, 1HV, 1HB, 0.1HRC, 0.1HRB, 1HS, 1MPa	
Accuracy	±6HLD (when HLD=800)	
Display	Leeb (HLD), converted hardness, material, impact direction, test times, average value, date	
Output	bluetooth, USB	
Applicable workpiece	minimum weight	5kg
		2kg (on solid support)
		0.1kg (coupled on plate)
	minimum thickness: 5mm	
minimum radius of curved surface: 30mm		
maximum roughness (Ra): 1.6µm		
Power supply	3×AAA batteries	
Dimension	150×84×28mm	
Weight	200g	

STANDARD DELIVERY

Main unit	1 pc
Impact device D	1 pc
Hardness test block D	1 pc
USB cable	1 pc
Small support ring	1 pc
Cleaning brush	1 pc

OPTIONAL ACCESSORY

Wireless printer	ISH-DS-PRINTER
Couplant	ISH-COUPPLANT
Support rings	page 738
Hardness test block D	HDT-B-HLD3

connected to computer by USB cable,
upload the data in real time



connected to computer by bluetooth module,
upload the data in real time



PORTABLE LEEB HARDNESS TESTER CODE ISH-SPHA

INSPECTION
CERTIFICATE

DATA
OUTPUT



- Based on Leeb (HL), converted to Vickers (HV), Brinell (HB), Rockwell (HRC and HRB), Shore (HS) and tensile strength (MPa)
- Connected with printer via bluetooth
- Connected with computer via USB port
- Up to 800 test results can be saved
- Tolerance testing
- Touch screen operation, large display with backlight
- Language: English, Chinese, Italian, German, French and Portuguese
- Automatic power off
- According to ASTM A 956



software flash disk
(included)



hardness test
block D (included)



small support ring
(included)



printer (included)

SPECIFICATION

Min. reading	1HL, 1HV, 1HB, 0.1HRC, 0.1HRB, 1HS, 1MPa
Accuracy	±6HL (when HL=800)
Display	Leeb (HL), converted hardness, material, impact direction, test times, average value, deviation, time
Output	bluetooth and USB
Power supply	built-in rechargeable battery
Dimension	135×83×24mm
Weight	350g

STANDARD DELIVERY

Main unit	1 pc
Impact device D	1 pc
Printer	1 pc
Hardness test block D	1 pc
Small support ring	1 pc
Cleaning brush	1 pc
AC/DC adapter	1 pc
Software flash disk and USB cable	1 pc
Pen for touch screen	1 pc

OPTIONAL ACCESSORY

Impact device DC	ISH-SPHA-DC
Impact device C	ISH-SPHA-C
Impact device D+15	ISH-SPHA-D15
Impact device DL	ISH-SPHA-DL
Impact device G	ISH-SPHA-G
Hardness test block D *	HDT-B-HLD3
Hardness test block G *	HDT-B-HLG2
Couplant	ISH-COUPPLANT
Support rings	page 738

* Hardness test block G (HDT-B-HLG2) is for impact device G (ISH-SPHA-G).
Hardness test block D (HDT-B-HLD3) is for all other impact devices.

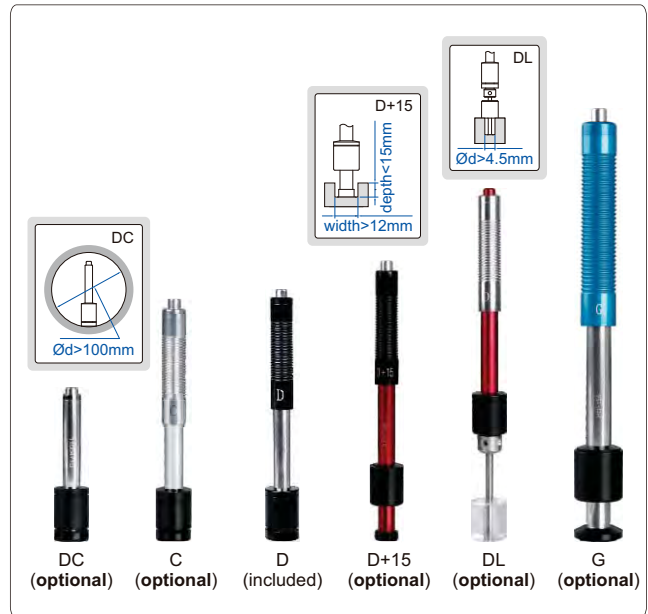

DC (optional) C (optional) D (included) D+15 (optional) DL (optional) G (optional)

APPLICABLE WORKPIECE

Impact device	DC	C	D	D+15	DL	G
Application	inner wall of small space	small or thin workpiece, coating layer	general use	deep groove	narrow slot or small hole	casting or forging workpiece
Maximum roughness of workpiece (Ra)	1.6µm	0.4µm	1.6µm	1.6µm	1.6µm	7µm
Minimum weight of workpiece	direct measurement	5kg	1.5kg	5kg	5kg	15kg
	on solid support	2kg	0.5kg	2kg	2kg	5kg
	coupled on plate	0.1kg	0.02kg	0.1kg	0.1kg	0.5kg
Minimum thickness of workpiece	5mm	1mm	5mm	5mm	5mm	10mm

PORTABLE LEEB HARDNESS TESTERS (BASIC TYPE)

- Can change probes
- Dual-coil probe for high accuracy
- Universal testing angle, no need to set impact direction
- Based on Leeb (HLD), converted to Vickers (HV), Brinell (HB), Rockwell (HRC, HRB), Shore (HSD) and tensile strength (σ_b)
- Dual value display, shows both Leeb and converted hardness
- Large LCD display with backlight
- Can choose large font display and statistics display
- Automatically calculate maximum, minimum and average value
- Save 300 data
- Operation temperature: -10°C – 45°C
- According to ASTM A956, GB/T 17394

SPECIFICATION

Code	HDT-LP200	HDT-LP200B
Printer	not included	included
Resolution	1HLD/1HV/1HB/0.1HRC/0.1HRB/0.1HSD/1 σ_b	
Accuracy	$\pm 6\text{HLD}$ (when HLD=800)	
Measuring range	HL 170-960/HRC 17-70/HRB 13-109/HB 20-655/HV 80-940/HSD 32-99.5/ $\sigma_b(\text{rm})$ 255-2639N/mm ²	
Power supply	2xAAA battery	
Dimension	135x77x32mm	
Weight	240g	

STANDARD DELIVERY

Main unit	1 pc
Hardness test block D	1 pc
Small support ring	1 pc
Cleaning brush	1 pc
Impact device D	1 pc
Bluetooth printer (included in HDT-LP200B)	1 pc

OPTIONAL ACCESSORY

Impact device DC	HDT-LP200-DC
Impact device C	HDT-LP200-C
Impact device D+15	HDT-LP200-D15
Impact device DL	HDT-LP200-DL
Impact device G	HDT-LP200-G
Hardness test block D**	HDT-B-HLD3
Hardness test block G*	HDT-B-HLG2
Support rings	page 738

* Hardness test block G (HDT-B-HLG2) is for impact device G (HDT-LP200-G)

** Hardness test block D (HDT-B-HLD3) is for all other impact devices



HDT-LP200



hardness test block D (included)



small support ring (included)



bluetooth printer (included in HDT-LP200B)



large font display

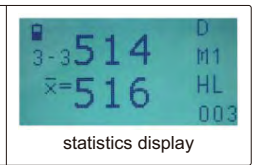

statistics display

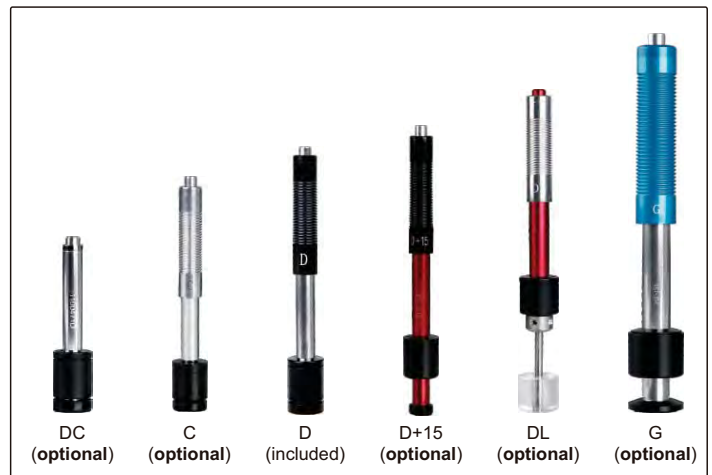

DC (optional)

C (optional)

D (included)

D+15 (optional)

DL (optional)

G (optional)

APPLICABLE WORKPIECE

Impact device	DC	C	D	D+15	DL	G
Application	inner wall of small space	small or thin workpiece, coating layer	general use	deep groove	narrow slot or small hole	casting or forging workpiece
Maximum roughness of workpiece (Ra)	2 μm	0.4 μm	2 μm	2 μm	2 μm	7 μm
Minimum weight of workpiece	direct measurement	5kg	1.5kg	5kg	5kg	15kg
	on solid support	2kg	0.5kg	2kg	2kg	5kg
	coupled on plate	0.05kg	0.02kg	0.05kg	0.1kg	0.05kg
Minimum thickness of workpiece	3mm	1mm	3mm	3mm	3mm	10mm

PORTABLE LEEB HARDNESS TESTER (WITH WIRELESS PROBE) CODE HDT-WP201



- Bluetooth digital probe
- Universal testing angle, no need to set impact direction
- Based on Leeb (HLD), converted to Vickers (HV), Brinell (HB), Rockwell (HRC, HRB), Shore (HSD) and tensile strength (σ)
- Dual value display, shows both Leeb and converted hardness
- Large LCD display with backlight
- Can choose large font display and statistics display
- Automatically calculate maximum, minimum and average value
- Save 300 data
- Operation temperature: $-10^{\circ}\text{C}\sim 45^{\circ}\text{C}$
- According to ASTM A956, DIN 50156 GB/T 17394



hardness test block D (included)



small support ring (included)



bluetooth printer (optional)

SPECIFICATION

Resolution	1HLD/1HV/1HB/0.1HRC/0.1HRB/0.1HSD/1 σ
Accuracy	$\pm 6\text{HLD}$ (when $\text{HLD}=800$)
Measuring range	HL 170-960/HRC 17-69/HRB 13-101.7/ HB 20-655/HV 80-940/HSD 32-99.5/ σ (rm) 255-2180N/mm ²
Power supply	2xAA battery
Dimension	135x77x32mm
Weight	240g



large font display

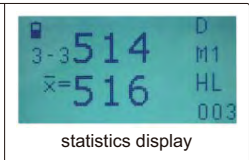

statistics display

STANDARD DELIVERY

Main unit	1 pc
Hardness test block D	1 pc
Small support ring	1 pc
Cleaning brush	1 pc
Impact device D	1 pc

OPTIONAL ACCESSORY

Impact device DC	HDT-WL320-DCW
Impact device C	HDT-WL320-CW
Impact device DL	HDT-WL320-DLW
Impact device G	HDT-WL320-GW
Hardness test block D	HDT-B-HLD3
Bluetooth printer	ISH-LP200-PRINTER
Support rings	page 738

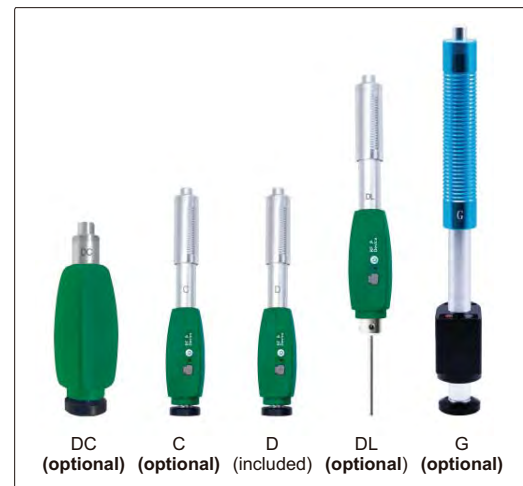

DC (optional) C (optional) D (included) DL (optional) G (optional)

APPLICABLE WORKPIECE

Impact device	DC	C	D	DL	G
Application	inner wall of small space	small or thin workpiece, coating layer	general use	narrow slot or small hole	casting or forging workpiece
Maximum roughness of workpiece (Ra)	2 μm	0.4 μm	2 μm	2 μm	7 μm
Minimum weight of workpiece	direct measurement	5kg	1.5kg	5kg	15kg
	on solid support	2kg	0.5kg	2kg	5kg
	coupled on plate	0.05kg	0.02kg	0.05kg	0.5kg
Minimum thickness of workpiece	3mm	1mm	3mm	3mm	10mm

DATA OUTPUT **HIGH ACCURACY** **DL PROBE IS OPTIONAL**

PEN-TYPE LEEB HARDNESS TESTER (ADVANCED TYPE) CODE HDT-L410

INSPECTION CERTIFICATE



DL probe can be installed (optional)



- Metal housing
- HD TFT 320×320 display
- Impact device D
- Based on Leeb (HLD), converted to Vickers (HV), Brinell (HB), Rockwell (HRC, HRA and HRB), Shore (HS) and tensile strength (SGM)
- Four display modes
- Automatic direction correction
- Tolerance testing
- Automatic power off, automatic calculation of statistics
- Dual value display, shows both Leeb and other conversion values
- 31 files can be saved, each containing 100 measurement data
- Connected to PC software via USB or Bluetooth 2.0
- Connected with printer via Bluetooth
- Operation temperature: -20°C~70°C
- According to ASTM A956, DIN 50156, GB/T 17394

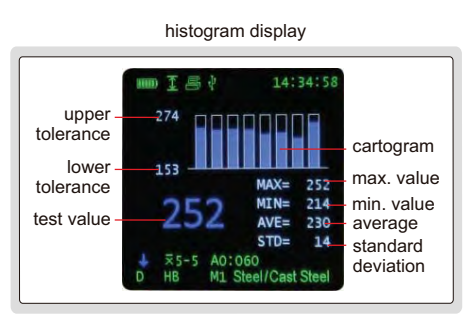
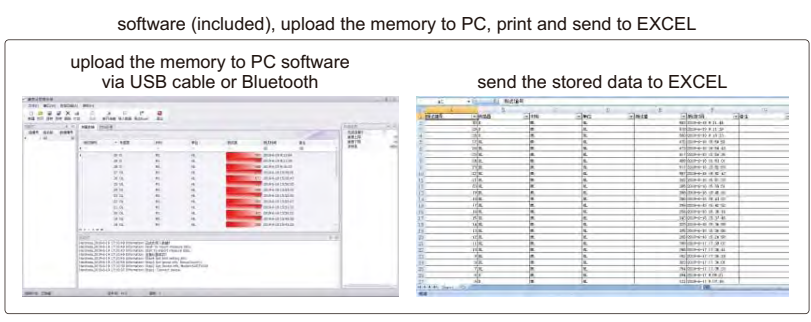
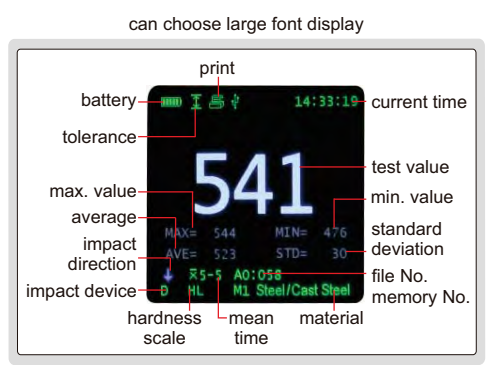
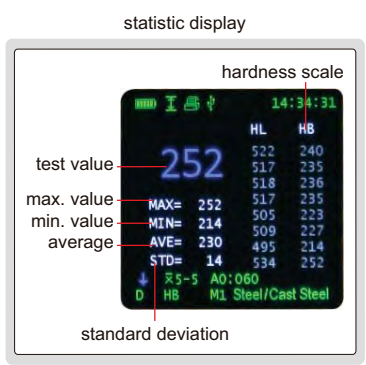
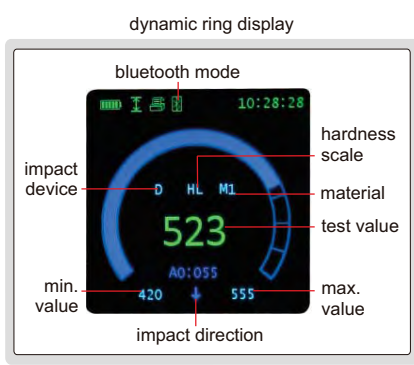

SPECIFICATION

Resolution	1HLD, 1HV, 1HB, 0.1HRC, 0.1HRB, 0.1HRA, 0.1HS, 1SGM	
Accuracy	±4HLD (when HLD=800)	
Output	USB and bluetooth	
Applicable workpiece	minimum weight	5kg (direct measurement)
		2kg (on solid support)
		0.05kg (coupled on plate)
	minimum thickness: 5mm	
minimum radius of curved surface: 30mm		
maximum roughness (Ra): 2µm		
Power supply	built-in 3.7V rechargeable battery	
Dimension	148×44×22mm	
Weight	115g	

STANDARD DELIVERY

Main unit	1 pc
Hardness test block D	1 pc
Small support ring	1 pc
Cleaning brush	1 pc
AC/DC adapter	1 pc
Software flash disk and USB cable	1 pc

OPTIONAL ACCESSORY

Printer	HDT-L410-PRINTER
Support rings	page 738
Hardness test block D	HDT-B-HLD3
DL probe	HDT-L410-DL

PEN-TYPE LEEB HARDNESS TESTER (STANDARD TYPE) CODE HDT-B430



DATA OUTPUT

DL PROBE IS OPTIONAL



software flash disk (included)



hardness test block D (included)



small support ring (included)



wireless printer (optional)



VIDEO



DL probe can be installed (optional)



- Impact device D is included
- High contrast OLED display
- Based on Leeb (HLD), converted to Vickers (HV), Brinell (HB), Rockwell (HRC, HRA and HRB), Shore (HS) and tensile strength (σ_b)
- Dual value display, shows both Leeb and other conversion values
- No need to set the testing direction
- 31 files can be saved, each containing 100 measurement data
- Automatically calculate maximum, minimum, average value
- Connected to PC software via USB or Bluetooth
- Connected with printer via Bluetooth
- Operation temperature: $-20^{\circ}\text{C}\sim 45^{\circ}\text{C}$
- According to ASTM A956, DIN 50156 GB/T, 17394

standard display

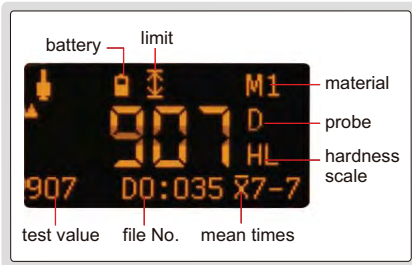

big character display

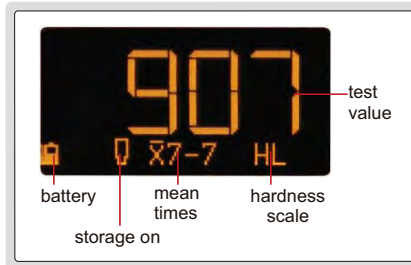

average display

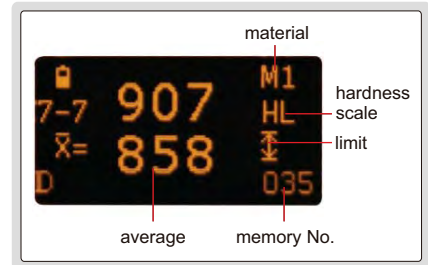

statistical parameter display

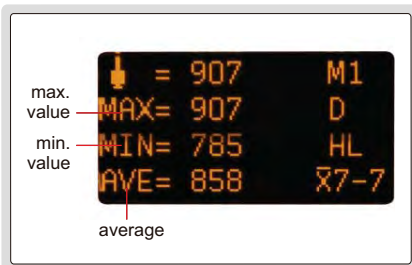

software (included), upload the memory to PC, print and send to EXCEL

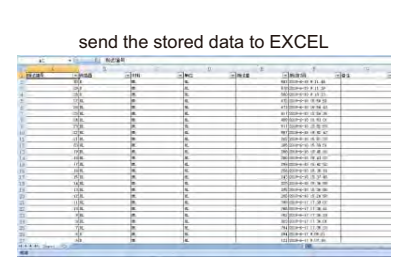
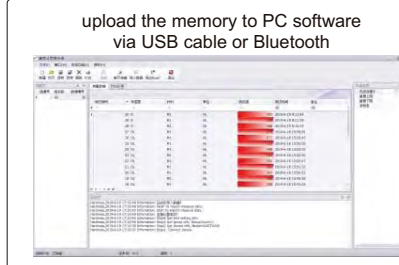

SPECIFICATION

Resolution	1HLD, 1HV, 1HB, 0.1HRC, 0.1HRB, 0.1HRA, 0.1HSD, 16b	
Accuracy	$\pm 6\text{HLD}$ (when $\text{HLD}=800$)	
Measuring range	HLD170-960, HRC17-70, HRB13-109, HB20-655, HV80-940 HSD32-99.5, HRA30-88, σ_b (rm) 255-2180N/mm ²	
Applicable workpiece	minimum weight	5kg (direct measurement) 2kg (on solid support) 0.05kg (coupled on plate)
	minimum thickness:	5mm
	minimum radius of curved surface:	30mm
	maximum roughness (Ra):	2 μm
Output	USB and bluetooth	
Power supply	built-in 3.7V rechargeable battery	
Dimension	148×44×28mm	
Weight	110g	

STANDARD DELIVERY

Main unit	1 pc
Hardness test block D	1 pc
Small support ring	1 pc
Cleaning brush	1 pc
AC/DC adapter	1 pc
Software flash disk and USB cable	1 pc

OPTIONAL ACCESSORY

Printer	ISH-LP200-PRINTER
Support rings	page 738
Hardness test block D	HDT-B-HLD3
DL probe	HDT-L410-DL

DATA
OUTPUT

INSPECTION
CERTIFICATE

PEN-TYPE LEEB HARDNESS TESTER (BASIC TYPE) CODE HDT-L411



software flash disk
(included)



hardness test
block D (included)



small support ring
(included)



can choose large font display

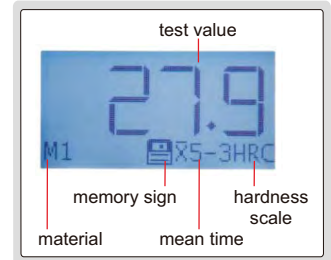

software (included), upload the memory
to PC, print and send to EXCEL

upload the memory to PC
software via USB cable



send the stored data to EXCEL

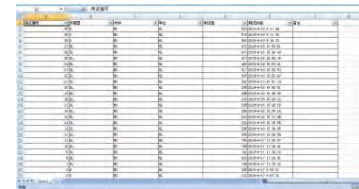

- Impact device D
- Universal testing angle, no need to set impact direction
- Dual-coil probe, high accuracy
- Based on Leeb (HLD), converted to Vickers (HV), Brinell (HB), Rockwell (HRC, HRA and HRB), Shore (HS) and tensile strength (SGM)
- Dual value display, shows both Leeb and converted hardness
- High contrast digital LCD display
- Can choose large font display
- Automatically calculate maximum, minimum, average value
- Connected to PC via USB
- Save 999 data
- Operation temperature: -20°C~45°C
- According to ASTM A956, DIN 50156, GB/T 17394

SPECIFICATION

Resolution	1HLD, 1HV, 1HB, 0.1HRC, 0.1HRB, 0.1HRA, 0.1HS, 1SGM	
Accuracy	±6HLD (when HLD=800)	
Output	USB	
Measuring range	HL100-960, HRC1-74.7, HRB1.2-140, HB28-1027, HV45-1230, HS4-112, HRA7-88.5, SGM (rm) 118-3315N/mm ²	
Applicable workpiece	minimum weight	5kg (direct measurement)
		2kg (on solid support)
		0.05kg (coupled on plate)
	minimum thickness: 5mm	
minimum radius of curved surface: 30mm		
maximum roughness (Ra): 2µm		
Power supply	1xAAA battery	
Dimension	148×45×21mm	
Weight	105g	

STANDARD DELIVERY

Main unit	1 pc
Hardness test block D	1 pc
Cleaning brush	1 pc
AAA battery	1 pc
Small support ring	1 pc
Software flash disk and USB cable	1 pc

OPTIONAL ACCESSORY

Support rings	page 738
Hardness test block D	HDT-B-HLD3

SUPPORT RING SET FOR PORTABLE LEEB HARDNESS TESTER CODE ISH-PH-SP9



type A

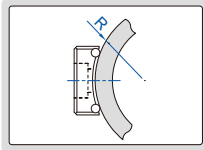

type B

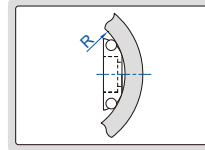

type C

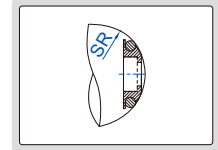

SPECIFICATION

Type	Applicable workpieces	Range (mm)	Quantity
A	cylindrical outside surface	R10-15	3 pcs
		R14.5-30	
		R25-50	
B	cylindrical inside surface	R11-13	3 pcs
		R12.5-17	
		R16.5-30	
C	spherical inside surface	SR11-13	3 pcs
		SR12.5-17	
		SR16.5-30	
D	spherical outside surface	SR10-15	2 pcs
		SR14.5-30	
E	cylindrical outside surface	R>10	1 pc

type D



type E

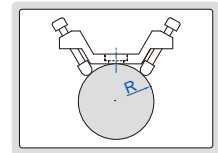
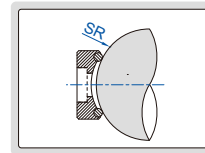

DIGITAL MAGNETIC ROCKWELL HARDNESS TESTER CODE ISHR-D121

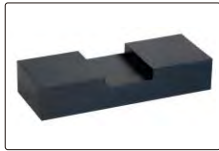

flat anvil for test block
(included)



- Apply to large and heavy steel or iron workpieces
- With statistic function, display average, maximum and minimum values
- Convert to HV, HB and tensile strength
- According to ISO 6508, ASTM E18



SPECIFICATION

Hardness scale	HRA, HRB, HRC
Preliminary test force	10kg
Test force	60kg, 100kg, 150kg
Load control	manual
Min. reading	0.1HR
Flat workpiece requirement	length>190mm, width>60mm, thickness>5mm
Cylinder or tube workpiece requirement	length>200mm, diameter>Ø50mm, wall thickness>8mm
Power supply	3×AA batteries
Dimension	245×105×230mm
Weight	5.3kg

STANDARD DELIVERY

Main unit	1 pc
Flat anvil	1 pc
Diamond indenter	1 pc
Ø1.5875mm carbide ball indenter	1 pc
Hardness test block HRB85~95	1 pc
Hardness test block HRC60~70	1 pc
Hardness test block HRC20~30	1 pc

MAGNETIC ROCKWELL HARDNESS TESTER CODE ISHR-M111

- Apply to large and heavy steel or iron workpieces
- According to ISO 6508, ASTM E18

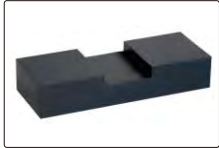

flat anvil for test block (included)



supports for cylinder or tube workpieces (included)



magnifier with LED (included)

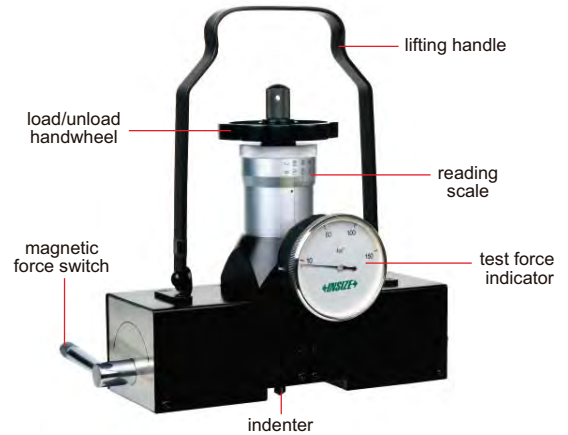

SPECIFICATION

Hardness scale	HRA, HRB, HRC, HRD, HRF, HRG
Preliminary test force	10kg
Test force	60kg, 100kg, 150kg
Load control	manual
Min. reading	1HR
Flat workpiece requirement	length>180mm, width>60mm, thickness>5mm
Cylinder or tube workpiece requirement	length>180mm, diameter>Ø50mm, wall thickness>8mm
Dimension	220×70×220mm
Weight	4.7kg

STANDARD DELIVERY

Main unit	1 pc
Diamond indenter	1 pc
Ø1.5875mm carbide ball indenter	2 pcs
Hardness test block HRB85~95	1 pc
Hardness test block HRC60~70	1 pc
Hardness test block HRC20~30	1 pc
Flat anvil	1 pc
Support	4 pcs
Magnifier with LED	1 pc



MAGNETIC BRINELL/ROCKWELL HARDNESS TESTER CODE ISHR-B141

- Apply to large steel or iron workpieces
- According to ISO 6508, ASTM E18

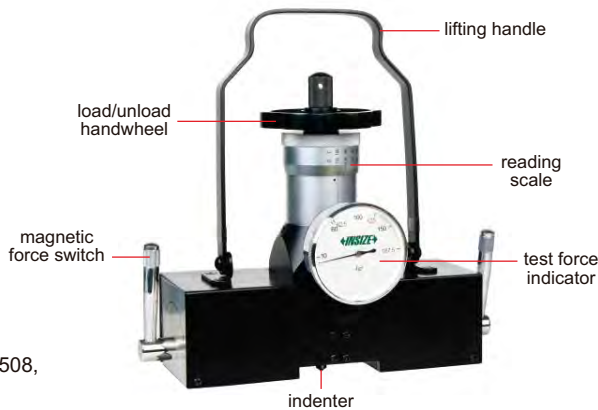

flat anvil for test block (included)



supports for cylinder or tube workpieces (included)



magnifier with LED (included)



measuring microscope (included)

SPECIFICATION

Rockwell scale	HRA, HRB, HRC, HRD, HRF, HRG
Brinell measuring range	20~650HBW
Rockwell test force	10kg preload, 60kg, 100kg, 150kg total load
Brinell test force	62.5kg, 125kg, 187.5kg
Load control	manual
Min. Rockwell reading	1HR
Measuring microscope	40X, graduation 0.01mm
Flat workpiece requirement	length>180mm, width>60mm, thickness>5mm
Cylinder and tube workpiece requirement	length>180mm, diameter>Ø50mm, thickness>8mm
Dimension	220×70×220mm
Weight	4.7kg

STANDARD DELIVERY

Main unit	1 pc
Flat anvil	1 pc
Support	4 pcs
Diamond Rockwell indenter	1 pc
Ø1.5875mm carbide ball indenter	1 pc
Ø2.5mm Brinell indenter	1 pc
Hardness test block HRB85~95	1 pc
Hardness test block HRC60~70	1 pc
Hardness test block HRC20~30	1 pc
Brinell test block	1 pc
Measuring microscope	1 pc
Magnifier with LED	1 pc

PORTABLE ROCKWELL HARDNESS TESTER CODE ISHR-P151



anvil extension for thin workpieces (included)



VIDEO



flat anvil (included)



V-type anvil (included)

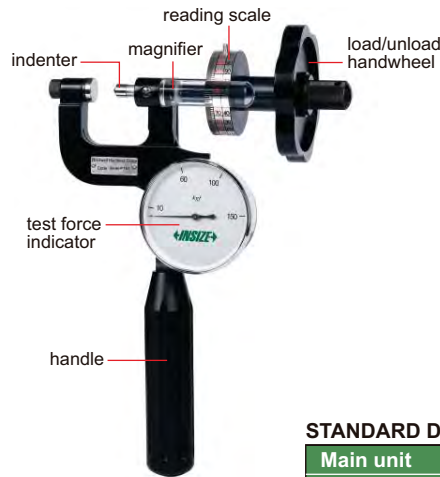

base (included)

- According to ISO 6508, ASTM E18

SPECIFICATION

Hardness scale	HRA, HRB, HRC, HRD, HRF, HRG
Preliminary test force	10kg
Test force	60kg, 100kg, 150kg
Load control	manual
Min. reading	1HR
Max. workpiece thickness	25mm
Max. testing width	25mm (from the center of indenter to the main body)
Dimension	240×70×160mm
Weight (with base)	2.5kg

STANDARD DELIVERY

Main unit	1 pc
Diamond indenter	1 pc
Ø1.5875mm carbide ball indenter	2 pcs
Hardness test block HRB88-95	1 pc
Hardness test block HRC60-65	1 pc
Hardness test block HRC20-30	1 pc
Flat anvil	1 pc
V-type anvil	1 pc
Base	1 pc
Anvil extension	1 pc
Magnifier	2 pcs

PIN BRINELL HARDNESS TESTER CODE ISHB-P101

- Measure Brinell hardness of large and heavy workpieces
- 1580kg test force and Ø7.26mm ball indenter, equal to 3000kg test force and Ø10mm ball indenter
- Static and impact test modes
- According to ISO and ASTM standard



static test clamp

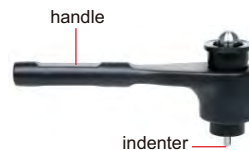

impact test handle



VIDEO

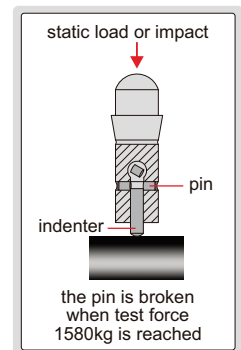

static test



impact test



measuring microscope (included)



pins (included)



V-type anvil (included)

SPECIFICATION

Measuring range	100~350HBW (with Ø7.26mm indenter, included) 350~650HBW (with Ø4mm indenter, optional)
Test force	1580kg
Accuracy	static test: ±3% impact test: ±5%
Measuring microscope	20X, graduation 0.01mm
Max. workpiece height of static test	150mm
Max. testing width of static test	80mm (from the center of indenter to the clamp)
Dimension	195×60×350mm
Weight	4.2kg

STANDARD DELIVERY

Static test clamp	1 pc
Impact test handle	1 pc
Flat anvil	1 pc
V-type anvil	1 pc
Ø7.26mm indenter	1 pc
Hardness test block	1 pc
Pin	250 pcs
Measuring microscope	1 pc

OPTIONAL ACCESSORY

Ø4mm indenter	ISHB-P101-INDENTER
Pin (250 pcs)	ISHB-P101-PIN

HAMMER IMPACT BRINELL HARDNESS TESTER CODE HDT-PB350



hammer impact
to apply test force

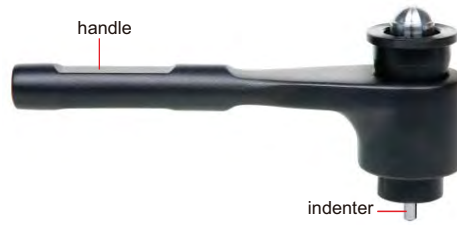

indenter



pins (included)



measuring microscope
(included)

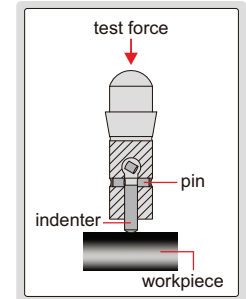

the pin is broken when
test force 1580kg is reached

- Measure Brinell hardness of large and heavy workpieces
- 1580kg test force and Ø7.26mm ball indenter, equal to 3000kg test force and Ø10mm ball indenter



VIDEO

SPECIFICATION

Measuring range	100~350HBW (with Ø7.26mm indenter, included) 350~650HBW (with Ø4mm indenter, optional)
Test force	1580kg
Accuracy	±5%HBW
Repeatability	±5%HBW
Measuring microscope	20X, graduation 0.01mm
Dimension	200×50×100mm
Weight	0.8kg

STANDARD DELIVERY

Main unit	1 pc
Ø7.26mm indenter	1 pc
Hardness test block	1 pc
Pin	250 pcs
Pin removal tool	1 pc
Measuring microscope	1 pc

OPTIONAL ACCESSORY

Ø4mm indenter	ISHB-P101-INDENTER
Pin (250 pcs)	ISHB-P101-PIN

HYDRAULIC BRINELL HARDNESS TESTER CODE ISHB-H131



V-type anvil
(included)



spherical anvil
(included)



measuring microscope
(included)

- According to ISO 6506, ASTM E10

SPECIFICATION

Measuring range	16~650HBW
Test force	3000kg
Indenter	Ø10mm carbide ball
Measuring microscope	20X, graduation 0.01mm
Max. workpiece height	350mm
Max. testing width	90mm (from the center of indenter to the column)
Dimension	270×225×570mm
Weight	13.8kg

STANDARD DELIVERY

Main unit	1 pc
Flat anvil	1 pc
V-type anvil	1 pc
Spherical anvil	1 pc
Ø10mm carbide ball	2 pcs
Brinell test block	2 pcs
Measuring microscope	1 pc

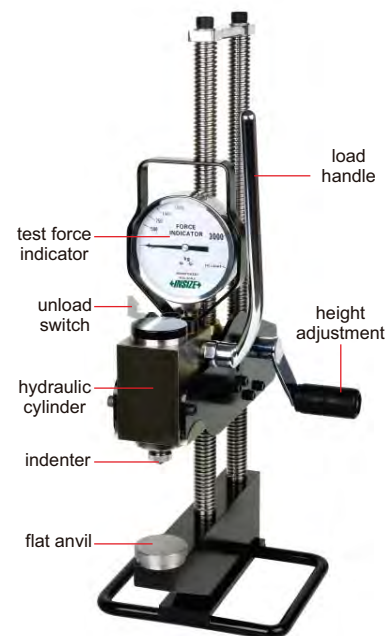

VIDEO

CHAIN TYPE HYDRAULIC BRINELL HARDNESS TESTER CODE ISHB-C161

- To measure the hardness of cylinders or tubes
- According to ISO 6506, ASTM E10



SPECIFICATION

Measuring range	32~650HBW
Workpiece diameter range	Ø150~Ø500mm
Test force	3000kg
Indenter	Ø10mm carbide ball
Measuring microscope	20X, graduation 0.01mm
Dimension	270×225×570mm
Weight	14.5kg

STANDARD DELIVERY

Main unit	1 pc
1.5m chain	1 pc
Ø10mm carbide ball	2 pcs
Brinell test block	2 pcs
Measuring microscope	1 pc

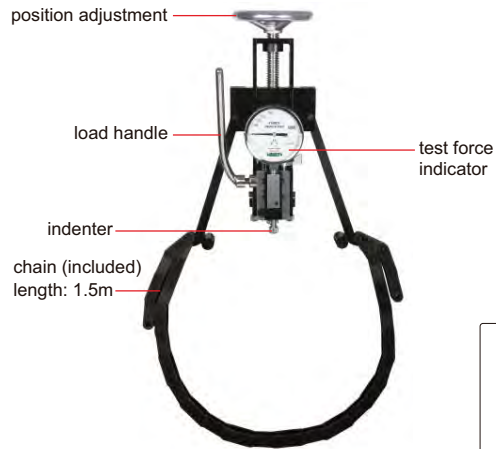

measuring microscope (included)

ALUMINUM HARDNESS TESTERS

- To measure the hardness of soft metal such as aluminum alloy, copper, brass, soft steel, etc.
- According to ASTM B647-84 (2000)

STANDARD DELIVERY

Main unit	1 pc
Spare indenter	1 pc
Hardness test block	1 pc
Wrench	1 pc



ISHW-L20B

SPECIFICATION

Code	ISHW-L20	ISHW-L20A	ISHW-L20B	ISHW-B70	ISHW-B75	ISHW-B92
Application	for aluminum alloy general use	for aluminum alloy thick workpiece	for aluminum alloy small tube	for hard aluminum alloy and hard brass	for soft brass and copper	for soft steel and cold-rolled steel
Thickness requirement of flat workpiece	0.6~6mm	0.6~13mm	0.6~8mm	0.6~6mm	0.6~6mm	0.6~6mm
Internal diameter requirement of tube workpiece	>Ø10mm	>Ø10mm	>Ø6mm	>Ø10mm	>Ø10mm	>Ø10mm
Wall thickness requirement of tube workpiece	0.6~6mm	6~13mm (internal diameter Ø10~23.3mm) 0.6~6mm (internal diameter >Ø23.3mm)	0.6~8mm	0.6~6mm	0.6~6mm	0.6~6mm
Hardness range	0~20HW					
Min. reading	1HW					
Accuracy	±0.5HW (at 5~17HW)					
Dimension	205×30×85mm					
Weight	500g					



- To measure the hardness of workpieces made of pure aluminum, aluminum alloy, fiber reinforced plastic, hard plastic, etc.
- According to ASTM B648-00, ASTM D2853-07

BARCOL HARDNESS TESTER CODE ISHB-B300

SPECIFICATION

Hardness range	0~100HBa (equal to 25~150HBW)
Min. reading	1HBa
Accuracy	±2HBa (at 42~52HBa) ±1HBa (at 84~88HBa)
Min. workpiece thickness	0.8mm
Dimension	142×65×90mm
Weight	500g

STANDARD DELIVERY

Main unit	1 pc
Spare indenter	2 pcs
Hardness test block	2 pcs
Wrench	1 pc



DIGITAL SHORE DUROMETERS



- According to ISO868, ISO7619, ASTM D 2240
- Average and peak (max.) mode
- Dwell time is adjustable
- Tolerance testing
- 500 memories
- Wireless connection to printer
- Handhold use or work with test stand (code **ISH-DS-STANDA**)
- Automatic power off



software flash disk
(included)



calibration block
(included)



printer (optional)

SPECIFICATION

Code	ISH-DSA	ISH-DSD	ISH-DSOO
Unit	Shore A	Shore D	Shore OO
Test material	soft plastic, soft rubber, etc.	hard plastic, hard rubber, etc.	very soft plastic, rubber, sponge, textile, etc.
Measuring range	0~100HA *	0~100HD *	0~100HOO
Resolution	0.1HA	0.1HD	0.1HOO
Accuracy	±1HA	±1HD	±1HOO
Indenter protrusion	2.5mm		
Output	wireless and USB		
Power supply	built-in rechargeable battery		
Dimension	153×50×29mm		
Weight	170g		

- * Use **ISH-DSD** when measuring result is higher than 90HA
Use **ISH-DSA** when measuring result is lower than 20HD

STANDARD DELIVERY

Main unit	1 pc
Calibration block	1 pc
Software and USB cable	1 pc
AC/DC adapter	1 pc

OPTIONAL ACCESSORY

Printer	ISH-DS-PRINTER
Test stand	ISH-DS-STANDA

TEST STAND FOR DIGITAL SHORE DUROMETERS CODE ISH-DS-STANDA

- For digital shore durometers (code **ISH-DSA**, **ISH-DSD** and **ISH-DSOO**)
- Perform repeatable hardness measurement due to fewer possibilities of human error or measurement variations
- Special structure for stable loading
- Weight block A (included) is for **ISH-DSA**, weight block D (optional) is for **ISH-DSD**, remove weight block for **ISH-DSOO**



weight block D (optional) for ISH-DSD

SPECIFICATION

Stage diameter	Ø115mm
Max. workpiece height	45mm
Max. testing width	63mm (from test point to the column)
Dimension	Ø195×370mm
Weight	5.61kg

STANDARD DELIVERY

Test stand	1 pc
Weight block A (for ISH-DSA)	1 pc

OPTIONAL ACCESSORY

Weight block D (for ISH-DSD)	ISH-DS-W4
------------------------------	-----------



SHORE DUROMETERS

INSIZE PLUS
MADE IN EUROPE



- According to ISO868, ISO7619, ASTM D 2240
- With peak value indicator
- Handhold use or work with test stand (code **ISH-OS2**)

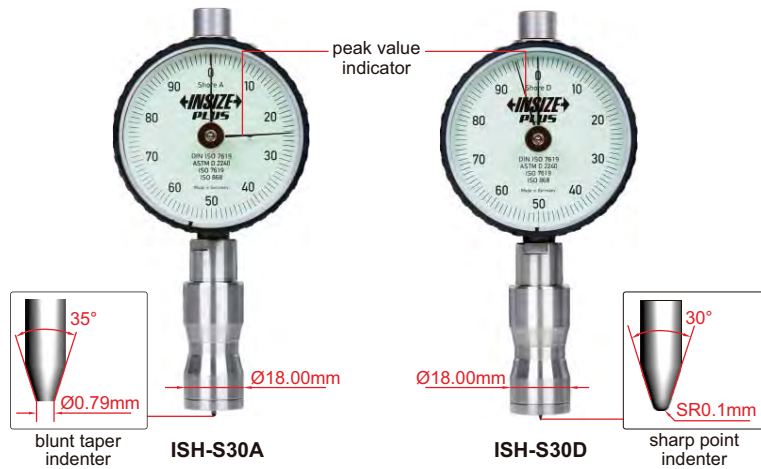

SPECIFICATION

Code	ISH-S30A	ISH-S30D
Scale	Shore A	Shore D
Test material	soft plastic, soft rubber, etc.	hard plastic, hard rubber, etc.
Measuring range *	0~100HA	0~100HD
Graduation	1HA	1HD
Accuracy	±0.5HA	±0.5HD
Indenter protrusion	2.5mm	
Weight	184g	

* Use **ISH-S30D** when measuring result is higher than 90HA
Use **ISH-S30A** when measuring result is lower than 20HD



TEST STAND FOR SHORE DUROMETERS CODE ISH-OS2

INSIZE PLUS
MADE IN EUROPE

- For shore durometers (code **ISH-S30A** and **ISH-S30D**)
- Perform repeatable hardness measurement due to fewer possibilities of human error or measurement variations
- Special structure for stable loading
- 1kg weight block (included) is for **ISH-S30A**, 4kg weight block (**optional**) is for **ISH-S30D**

SPECIFICATION

Stage diameter	Ø98mm
Max. workpiece height	180mm
Max. testing width	115mm (from test point to the column)
Dimension	Ø200×500mm
Weight	18kg

STANDARD DELIVERY

Test stand	1 pc
1kg weight block (for ISH-S30A)	1 pc
Calibration block	1 pc

OPTIONAL ACCESSORY

4kg weight block (for ISH-S30D)	ISH-OS2-W4
---------------------------------	------------

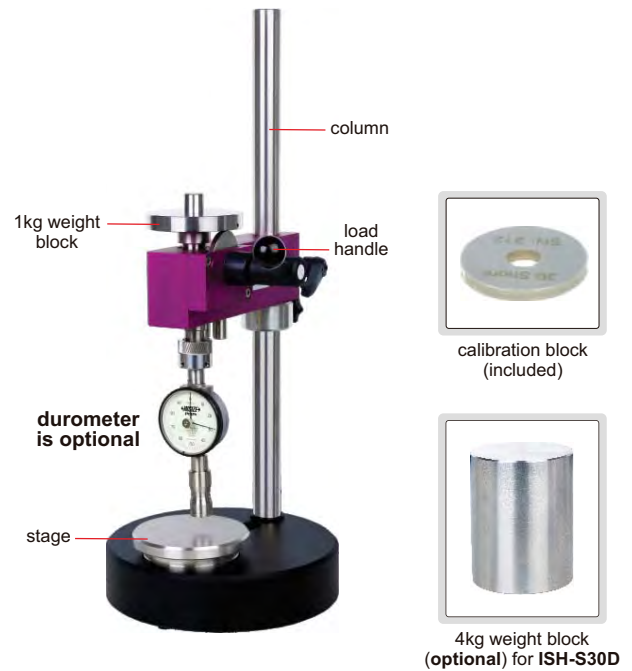

SHORE DUROMETERS

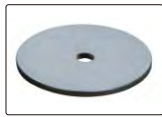

calibration block
(optional)

- According to ISO868, ISO7619, ASTM D 2240
- With peak value indicator
- Optional accessory: test stand **ISH-STAC** and **ISH-STD**

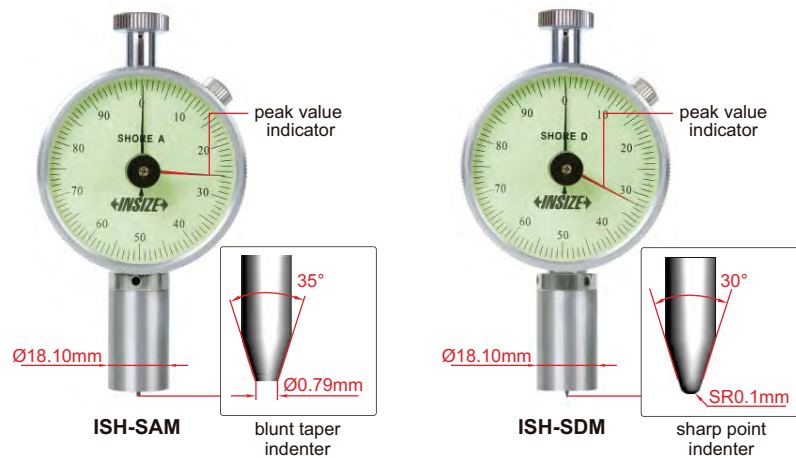

SPECIFICATION

Code	ISH-SAM	ISH-SDM
Scale	Shore A	Shore D
Application	nature rubber, soft elastomer, etc.	hard rubber, plastic, hard elastomer, etc.
Measuring range *	10~90HA	20~90HD
Graduation	1HA	1HD
Indenter protrusion	2.5mm	
Dimension	115×60×25mm	
Weight	160g	

- * Use **ISH-SDM** when measuring result is higher than 90HA
Use **ISH-SAM** when measuring result is lower than 20HD

OPTIONAL ACCESSORY

Calibration block	ISH-DS-BLOCK
-------------------	--------------



TEST STANDS FOR SHORE DUROMETERS

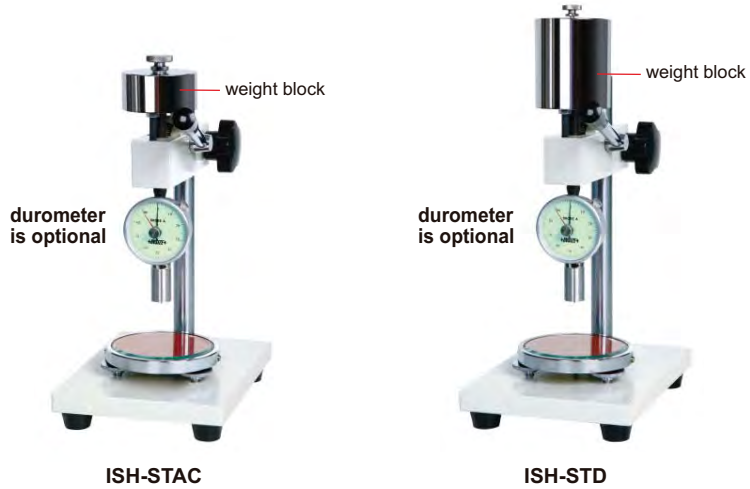

- For shore durometers (code **ISH-SAM** and **ISH-SDM**)
- Perform repeatable hardness measurement due to fewer possibilities of human error or measurement variations

SPECIFICATION

Code	ISH-STAC	ISH-STD
Applicable durometer	ISH-SAM	ISH-SDM
Stage diameter	Ø100mm	Ø100mm
Max. workpiece height	75mm	75mm
Max. testing width	65mm (from test point to the column)	65mm (from test point to the column)
Weight block	1kg	5kg

FRUIT HARDNESS TESTER

- Measure the hardness of apples, pears, strawberries and grapes, etc.
- The degree of ripeness can be judged by measuring the hardness of the fruit

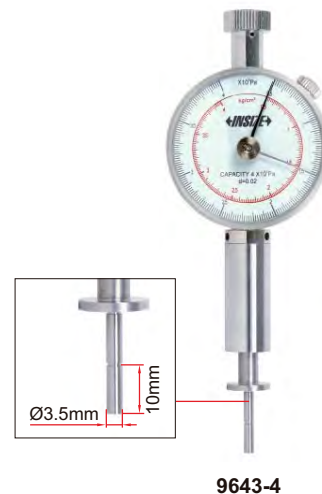

SPECIFICATION

Code	Range	Graduation	Accuracy	Probe diameter	Probe depth	Dimension	Weight
9643-4	0.5-4kg/cm ² (0.5-4×10 ⁵ Pa)	0.02kg/cm ² (0.02×10 ⁵ Pa)	±2%	Ø3.5mm	10mm	151×55×30mm	0.2kg



HARDNESS TEST BLOCKS



Rockwell



Vickers

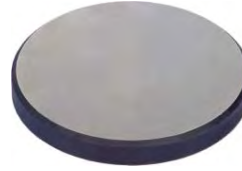

Brinell



Leeb



Micro-Vickers



Knoop



Ultrasonic



Shore

- Supplied with manufacturer inspection certificate

Rockwell hardness test blocks

Code	Type	Hardness
HDT-B-HRA	HRA	80-84
HDT-B-HRB	HRB	88-100
HDT-B-HRC1	HRC	20-30
HDT-B-HRC2	HRC	35-55
HDT-B-HRC3	HRC	60-70
HDT-B-HRD1	HRD	40-47
HDT-B-HRD2	HRD	55-63
HDT-B-HRD3	HRD	70-75
HDT-B-HRE	HRE	107-114
HDT-B-HRF	HRF	105-114
HDT-B-HRG1	HRG	57-82
HDT-B-HRG2	HRG	80-94

Rockwell superficial hardness test blocks

Code	Type	Hardness
HDT-B-HR15N1	HR15N	70-77
HDT-B-HR15N2	HR15N	78-88
HDT-B-HR15N3	HR15N	89-91
HDT-B-HR30N1	HR30N	42-54
HDT-B-HR30N2	HR30N	55-73
HDT-B-HR30N3	HR30N	74-80
HDT-B-HR45N1	HR45N	20-31
HDT-B-HR45N2	HR45N	32-61
HDT-B-HR45N3	HR45N	63-70
HDT-B-HR15T	HR15T	88-93
HDT-B-HR30T	HR30T	73-82
HDT-B-HR45T	HR45T	58-72

Leeb hardness test blocks

Code	Type	Hardness
HDT-B-HLD1	HLD	490-570
HDT-B-HLD2	HLD	590-670
HDT-B-HLD3	HLD	750-830
HDT-B-HLG1	HLG	460-540
HDT-B-HLG2	HLG	550-630

Vickers hardness test blocks

Code	Type	Hardness
HDT-B-HV5A	HV5	175-200
HDT-B-HV5B	HV5	200-300
HDT-B-HV5C	HV5	300-400
HDT-B-HV5D	HV5	400-500
HDT-B-HV5E	HV5	500-600
HDT-B-HV5F	HV5	600-700
HDT-B-HV5G	HV5	700-750
HDT-B-HV10A	HV10	175-200
HDT-B-HV10B	HV10	200-300
HDT-B-HV10C	HV10	300-400
HDT-B-HV10D	HV10	400-500
HDT-B-HV10E	HV10	500-600
HDT-B-HV10F	HV10	600-700
HDT-B-HV10G	HV10	700-750
HDT-B-HV30A	HV30	175-200
HDT-B-HV30B	HV30	200-300
HDT-B-HV30C	HV30	300-400
HDT-B-HV30D	HV30	400-500
HDT-B-HV30E	HV30	500-600
HDT-B-HV30F	HV30	600-700
HDT-B-HV30G	HV30	700-750
HDT-B-HV50A	HV50	175-200
HDT-B-HV50B	HV50	200-300
HDT-B-HV50C	HV50	300-400
HDT-B-HV50D	HV50	400-500
HDT-B-HV50E	HV50	500-600
HDT-B-HV50F	HV50	600-700
HDT-B-HV50G	HV50	700-750
HDT-B-HV100A	HV100	175-200
HDT-B-HV100B	HV100	200-300
HDT-B-HV100C	HV100	300-400
HDT-B-HV100D	HV100	400-500
HDT-B-HV100E	HV100	500-600
HDT-B-HV100F	HV100	600-700
HDT-B-HV100G	HV100	700-750

To be continued

Continued from previous page

Micro-Vickers hardness test blocks

Code	Type	Hardness
HDT-B-HV005A	HV0.05	200-300
HDT-B-HV005B	HV0.05	300-400
HDT-B-HV005C	HV0.05	400-500
HDT-B-HV005D	HV0.05	500-600
HDT-B-HV005E	HV0.05	600-700
HDT-B-HV005F	HV0.05	700-750
HDT-B-HV01A	HV0.1	200-300
HDT-B-HV01B	HV0.1	300-400
HDT-B-HV01C	HV0.1	400-500
HDT-B-HV01D	HV0.1	500-600
HDT-B-HV01E	HV0.1	600-700
HDT-B-HV01F	HV0.1	700-750
HDT-B-HV02A	HV0.2	200-300
HDT-B-HV02B	HV0.2	300-400
HDT-B-HV02C	HV0.2	400-500
HDT-B-HV02D	HV0.2	500-600
HDT-B-HV02E	HV0.2	600-700
HDT-B-HV02F	HV0.2	700-750
HDT-B-HV03A	HV0.3	200-300
HDT-B-HV03B	HV0.3	300-400
HDT-B-HV03C	HV0.3	400-500
HDT-B-HV03D	HV0.3	500-600
HDT-B-HV03E	HV0.3	600-700
HDT-B-HV03F	HV0.3	700-750
HDT-B-HV05A	HV0.5	200-300
HDT-B-HV05B	HV0.5	300-400
HDT-B-HV05C	HV0.5	400-500
HDT-B-HV05D	HV0.5	500-600
HDT-B-HV05E	HV0.5	600-700
HDT-B-HV05F	HV0.5	700-750
HDT-B-HV1A	HV1	200-300
HDT-B-HV1B	HV1	300-400
HDT-B-HV1C	HV1	400-500
HDT-B-HV1D	HV1	500-600
HDT-B-HV1E	HV1	600-700
HDT-B-HV1F	HV1	700-750

Knoop hardness test blocks

Code	Type	Hardness
HDT-B-HK005A	HK0.05	200-300
HDT-B-HK005B	HK0.05	400-500
HDT-B-HK005C	HK0.05	700-800
HDT-B-HK01A	HK0.1	200-300
HDT-B-HK01B	HK0.1	400-500
HDT-B-HK01C	HK0.1	700-800
HDT-B-HK02A	HK0.2	200-300
HDT-B-HK02B	HK0.2	400-500
HDT-B-HK02C	HK0.2	700-800
HDT-B-HK03A	HK0.3	200-300
HDT-B-HK03B	HK0.3	400-500
HDT-B-HK03C	HK0.3	700-800
HDT-B-HK05A	HK0.5	200-300
HDT-B-HK05B	HK0.5	400-500
HDT-B-HK05C	HK0.5	700-800
HDT-B-HK1A	HK1	200-300
HDT-B-HK1B	HK1	400-500
HDT-B-HK1C	HK1	700-800

Brinell hardness test blocks

Code	Type	Hardness
HDT-B-HB10A1	HBW10/3000	100-200
HDT-B-HB10A2	HBW10/3000	200-300
HDT-B-HB10A3	HBW10/3000	300-400
HDT-B-HB10A4	HBW10/3000	400-500
HDT-B-HB10A5	HBW10/3000	500-600
HDT-B-HB10A6	HBW10/3000	600-650
HDT-B-HB10B1	HBW10/1500	100-200
HDT-B-HB10B2	HBW10/1500	200-300
HDT-B-HB10B3	HBW10/1500	300-400
HDT-B-HB10B4	HBW10/1500	400-500
HDT-B-HB10B5	HBW10/1500	500-600
HDT-B-HB10B6	HBW10/1500	600-650
HDT-B-HB10C1	HBW10/1000	90-200
HDT-B-HB10C2	HBW10/1000	200-300
HDT-B-HB10C3	HBW10/1000	300-400
HDT-B-HB10C4	HBW10/1000	400-450
HDT-B-HB10D1	HBW10/500	90-200
HDT-B-HB10D2	HBW10/500	200-300
HDT-B-HB10D3	HBW10/500	300-400
HDT-B-HB10D4	HBW10/500	400-450
HDT-B-HB25A1	HBW2.5/187.5	100-200
HDT-B-HB25A2	HBW2.5/187.5	200-300
HDT-B-HB25A3	HBW2.5/187.5	300-400
HDT-B-HB25A4	HBW2.5/187.5	400-500
HDT-B-HB25A5	HBW2.5/187.5	500-600
HDT-B-HB25A6	HBW2.5/187.5	600-650
HDT-B-HB25B1	HBW2.5/62.5	90-200
HDT-B-HB25B2	HBW2.5/62.5	200-300
HDT-B-HB25B3	HBW2.5/62.5	300-400
HDT-B-HB25B4	HBW2.5/62.5	400-450
HDT-B-HB5A1	HBW5/750	100-200
HDT-B-HB5A2	HBW5/750	200-300
HDT-B-HB5A3	HBW5/750	300-400
HDT-B-HB5A4	HBW5/750	400-500
HDT-B-HB5A5	HBW5/750	500-600
HDT-B-HB5A6	HBW5/750	600-650
HDT-B-HB5B1	HBW5/250	90-200
HDT-B-HB5B2	HBW5/250	200-300
HDT-B-HB5B3	HBW5/250	300-400
HDT-B-HB5B4	HBW5/250	400-450

Shore hardness test blocks

Code	Type	Hardness *
HDT-B-SA	SA	6 pcs/set (30, 40, 50, 60, 70, 80)
HDT-B-SD	SD	3 pcs/set (15, 30, 90)

*The actual value may be slightly different when delivered

Ultrasonic hardness test blocks

Code	Type	Hardness
HDT-B-HRCU1	HRC	20-30
HDT-B-HRCU2	HRC	35-55
HDT-B-HRCU3	HRC	60-70
HDT-B-HV5U1	HV5	200-300
HDT-B-HV5U2	HV5	400-500
HDT-B-HV5U3	HV5	700-750
HDT-B-HB10U1	HBW10/1000	90-200
HDT-B-HB10U2	HBW10/3000	200-300
HDT-B-HB10U3	HBW10/3000	400-500

DATA OUTPUT

CONCRETE STRENGTH TESTERS



CST-D101



CST-D102

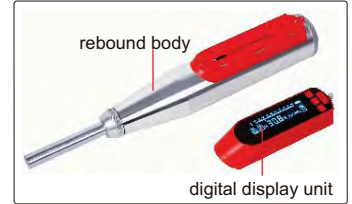

CST-D102 seperable

- Measure the strength of general building components, bridges and various concrete components (slabs, beams, columns, bridges, etc.)
- Angle, test surface, pumping, carbonization depth and other parameters can be customized according to the requirements
- The rebound body can be used for 2000 times
- USB data transmission
- The software can automatically generate the test report, and the strength curve can be customized and stored in the tester
- Storage and reading of 1000 test data
- According to JGJ/T23-2011, the curve of rebound meter can be customized to calculate the compressive strength of concrete

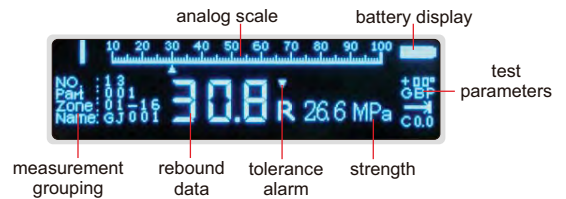

SPECIFICATION

Code	CST-D101	CST-D102
Display	OLED display	
Range	10-70N/mm ²	
Accuracy	±1R	
Parameter	MPa, N/mm ² , Kgf/mm ²	
Impact energy	2.207J, for testing common buildings or bridge structures	
Output	USB	
Structure	one body, non-seperable	seperable, the digital display unit can be reused
Memory	1000 data	
Operation temperature	-40°C~60°C	
Power supply	built-in rechargeable battery	
Dimension	280×75×60mm	
Weight	1.1kg	



software flash disk (included)



sander (included)



calibration block (optional)

STANDARD DELIVERY

Main unit	1 pc
Sander	1 pc
Power adapter	1 pc
Software and USB cable	1 pc

OPTIONAL ACCESSORY

Rebound body (for CST-D102)	CST-D102-REBOUND
Digital display unit (for CST-D102)	CST-D102-DISPLAY
Calibration block	CST-D-BLOCK

software (included) for uploading and storing data, printing and importing/exporting strength curves

ID	Rebound	FC	DC	RC	RC	RC	RC
1	11	17					
2	12	15.2					
3	13.4						
4	14	15.6					
5	15.8						
6	16	16					
7	16.2						
8	16.4						
9	16.6						
10	16.8						
11	17						
12	17.2						
13	17.4						
14	17.6						
15	17.8						
16	18						
17	18.2						
18	18.4						
19	18.6						
20	18.8						
21	19						
22	19.2						
23	19.4						
24	19.6						
25	19.8						
26	20	3.7	3.9	13.4	8.3		
27	20.2	3.8	3.9	13.6	8.4		
28	20.4	3.8	3.9	13.7	8.5		

Concrete compressive strength report detected by rebound method										
Project Name	Project	Forming Unit	Concrete Unit	Design Date	Test Date	Test Area	Area (m ²)	Volume (m ³)	Strength	Strength Date
Test No:	Test Name	Test Area	Volume	Yield	Volume	Area	Area	Volume	Strength	Strength Date
Test No:	Test Name	Test Area	Volume	Yield	Volume	Area	Area	Volume	Strength	Strength Date
1										
2										
3										
4										
5										
6										
7										
8										
9										
10										
11										
12										
13										
14										
15										
16										
17										
18										
19										
20										
21										
22										
23										
24										
25										
26										
27										
28										



Cutting Machines
Page 751-753



Grinders And Polishers
Page 754-757



Mounting Presses
Page 758-760



Metallurgical Microscopes
Page 760



Metallurgical Analysis Softwares
Page 760



Cutting Machine Accessories
Page 761-762



Mounting Press Accessories
Page 762-764



Grinder And Polisher Accessories
Page 764

AUTOMATIC CUTTING MACHINE (ADVANCED TYPE) CODE MLP-HCM102

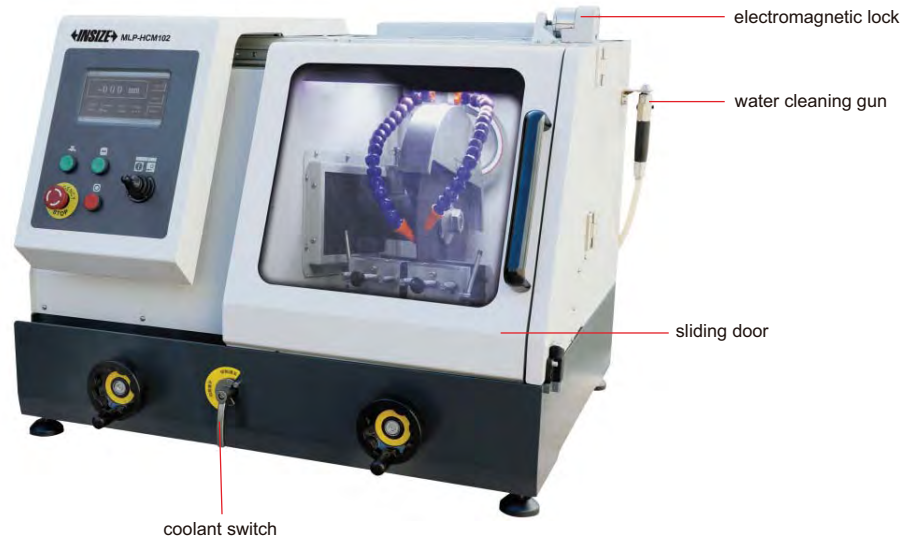

- Suitable for cylinder workpieces (diameter≤100mm) and rectangular samples (height≤70mm, width≤100mm)
- Cooling system avoids overheating and destroying sample structure
- Three cutting modes (manual, pulse, continuous cutting), the cutting feed speed and cutting stroke can be programmed

SPECIFICATION

Maximum cutting diameter	Ø100mm
Cutting blade	Ø350×2.5×Ø32mm
Rotation speed	2200r/min
Spindle travel	145mm
Table travel	300mm
Illumination	LED ceiling light
Noise	≤85dB
Cooling tank	60L
Removable baffle	contain
Table dimension	330×280mm
Power	3kW
Power supply	AC 380V, 50Hz
Dimension	900×860×620mm
Weight	285kg

STANDARD DELIVERY

Main unit	1 pc
Cutting blade	5 pcs
Cutting blade chuck	2 pcs
Coolant	1 barrel (4L)
Water tank	1 pc

OPTIONAL ACCESSORY

Coolant (4L, 1:20 diluted with water)	MLP-OL3
Cutting blade (Ø350×2.5×Ø32mm, 40 pcs/box)	MLP-50Z4
	MLP-60Y4 *
Cutting blade chuck (for Ø32mm cutting blade)	MLP-HCM102-CHUCK

* Special cutting blade for high hardness



coolant (included)



cutting blade MLP-50Z4 (included)



cutting blade MLP-60Y4 (optional)

CUTTING MACHINE (STANDARD TYPE) CODE MLP-CM60



- For metal and non-metal materials
- Cooling device avoids overheating and destroying sample structure
- With safety switch, the machine will automatically stop when the cover is opened



SPECIFICATION

Maximum cutting diameter	Ø60mm
Cutting blade	Ø250×1.5×Ø25.4mm
Rotation speed	2800r/min
Motor power	2.2kW
Power supply	AC 380V, 50Hz
Dimension	830×620×450mm
Weight	82kg

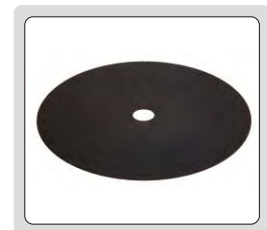

cutting blade MLP-CM60-CUT2
(included)

STANDARD DELIVERY

Main unit	1 pc
Cutting blade	2 pcs
Coolant	1 barrel (4L)
Water tank	1 pc



coolant (optional)

OPTIONAL ACCESSORY

Coolant (4L, 1:20 diluted with water)	MLP-OL3
Cutting blade (Ø250×1.5×Ø25.4mm, 60 pcs/box)	MLP-CM60-CUT2
Cutting blade (Ø250×2×Ø32mm, 50 pcs/box)	MLP-50Z2 *
Cutting blade chuck (for Ø32mm cutting blade)	MLP-CM60-CHUCK

* When use MLP-50Z2, please purchase MLP-CM60-CHUCK



CUTTING MACHINE (BASIC TYPE) CODE MLP-CM86



- For metal and non-metal materials
- Cooling device avoids overheating and destroying sample structure

SPECIFICATION

Maximum cutting diameter	Ø80mm
Cutting blade	Ø250×2×Ø32mm
Rotation speed	2800r/min
Power	3kW
Power supply	AC 380V, 50Hz
Dimension	690×790×670mm

STANDARD DELIVERY

Main unit	1 pc
Cutting blade	2 pcs
Coolant	1 barrel (4L)
Water tank	1 pc

OPTIONAL ACCESSORY

Coolant (4L, 1:20 diluted with water)	MLP-OL3
Cutting blade (Ø250×2×Ø32mm, 50 pcs/box)	MLP-60Y2*
	MLP-50Z2
Cutting blade chuck (for Ø32mm cutting blade)	MLP-CM86-CHUCK

*Special cutting blade for high hardness



coolant (included)



cutting blade MLP-50Z2 (included)



cutting blade MLP-60Y2 (optional)

GRINDER AND POLISHER (ADVANCED TYPE) CODE MLP-GP305



- Replaceable double wheels, rotation direction can be selected
- Multi sample holder, pneumatic single point loading, automatic abrasive distribution
- Adjustable speed
- Water cooling device and abrasive cleaning nozzle prevent samples from overheating and destroying structure
- ABS case and stainless steel parts, anti-corrosion, easy to clean
- Metallographic samples can be roughly ground, finely ground, roughly polished and finely polished

SPECIFICATION

Wheel diameter	Ø250mm (customizable Ø300mm)
Wheel rotation speed	50~1000r/min (stepless adjustable), 150r/min, 300r/min (two fixed speeds)
Wheel rotation direction	clockwise or counterclockwise
Grinding head speed	50~150r/min (stepless adjustable)
Pressure range	5~60N
Operation number	6
Operation time	0~995s
Sample diameter	Ø30mm (customizable Ø22mm, Ø25mm, Ø30mm, Ø40mm, Ø45mm, Ø50mm)
Air pressure	0.6~0.9MPa
Power supply	AC220V, 50Hz
Input power	1.1kW
Dimension	758×785×680mm
Weight	125kg

STANDARD DELIVERY

Main unit	1 pc
Silicon carbide paper	20 pcs each (240, 250, 400, 800, 1200), 100 pcs in total
Polishing cloth	3 pcs each (velvet silk, woolen fabric), 6 pcs in total
Polishing agent	1 pc (W2.5, 500ml)
Spray polish agent	1 pc (W2.5, 350ml)
Magnetic pad	2 pcs (Ø250mm)
Anti-stick disc	3 pcs (Ø250mm)

OPTIONAL ACCESSORY

Silicon carbide paper	MLP-SZG□□ *	50 pcs/box, select granularity: 120, 180, 240, 400, 600, 800, 1000, 1200, 1500, 2000
Polishing cloth	MLP-CT7	15 pcs/box, long velvet silk material
	MLP-CT27	15 pcs/box, woolen fabric
Diamond polishing liquid	MLP-DLA□□ *	500ml, select granularity (µm): W40, W28, W20, W14, W9, W7, W5, W3.5, W2.5, W1.5, W1.0, W0.5, W0.25
Spray polish agent	MLP-DSA□□ *	350ml, select granularity (µm): W40, W28, W20, W14, W10, W7, W5, W3.5, W2.5, W1.5, W1.0, W0.5, W0.25
Magnetic pad	MLP-AD2	Ø250mm
Anti-stick disc	MLP-DC2	Ø250mm

* □□ is granularity specification, for example, code **MLP-DLA40** stands for 40µm



silicon carbide paper
(included)

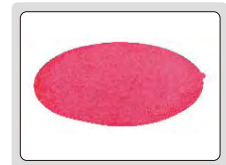

polishing cloth (included)



anti-stick disc (included)



magnetic pad (included)



GRINDER AND POLISHER (ADVANCED TYPE) CODE MLP-GP260



- ABS case and stainless steel parts, anti-corrosion, easy to clean
- Can hold up to 4 samples (6 holes are optional and can hold up to 6 samples)
- Smooth rotation, low noise
- Adjustable speed
- Water cooling device and abrasive cleaning nozzle prevent samples from overheating and destroying structure
- Wheel rotation direction can be selected
- Replaceable wheel

SPECIFICATION

Wheel diameter	Ø250mm
Wheel rotation speed	50~999r/min (stepless adjustable), 150 or 300r/min (two fixed speeds)
Wheel rotation direction	clockwise or counterclockwise
Grinding head speed	50~150r/min (stepless adjustable)
Pressure range	5~60N
Operation time	5~995s
Sample diameter	Ø30mm (can be customized)
Air pressure	0.6~0.9MPa
Power supply	AC 220V, 50Hz
Input power	1.1kW
Dimension	594×795×687mm
Weight	98kg



silicon carbide paper
(optional)

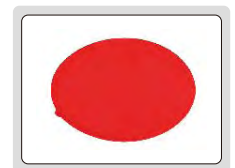

polishing cloth (optional)

STANDARD DELIVERY

Main unit	1 pc
Silicon carbide paper	6 pcs (200, 600, 1000)
Polishing cloth	4 pcs

OPTIONAL ACCESSORY

Silicon carbide paper	MLP-SZG□□*	50 pcs/box, select granularity: 120, 180, 240, 400, 600, 800, 1000, 1200, 1500, 2000
Polishing cloth	MLP-CT7	15 pcs/box, long velvet silk material
Diamond polishing liquid	MLP-DLA□□*	500ml, select granularity (µm): W40, W28, W20, W14, W9, W7, W5, W3.5, W2.5, W1.5, W1.0, W0.5, W0.25

* □□ is granularity specification, for example, code **MLP-DLA40** stands for 40µm

GRINDERS AND POLISHERS (STANDARD TYPE)



- ABS case and stainless steel parts, anti-corrosion, easy to clean
- Replaceable double wheel, wheel can be controlled independently, rotation direction can be selected
- Smooth rotation, low noise
- Four fixed speeds/stepless adjustable speed
- Water cooling device, prevent samples from overheating and destroying structure
- Metallographic samples can be roughly ground, finely ground, roughly polished and finely polished



MLP-GP280



silicon carbide paper
(optional)

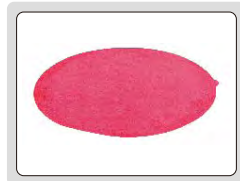

polishing cloth (optional)



magnetic pad (optional)



anti-stick disc
(optional)

SPECIFICATION

Code	MLP-GP270	MLP-GP280
Wheel diameter	Ø203mm	Ø250mm
Wheel rotation speed	0-1400r/min (stepless adjustable)	0-1000r/min (stepless adjustable)
Wheel rotation direction	clockwise or counterclockwise	
Fixed speed	150r/min, 300r/min, 600r/min, 1000r/min	
Power supply	AC 220V, 50Hz	
Input power	1.5kW	
Dimension	758×785×310mm	
Weight	50kg	

STANDARD DELIVERY

Main unit	1 pc
Silicon carbide paper	5 pcs each (240, 400, 800, 1200), 20 pcs in total
Polishing cloth	3 pcs
Polishing agent	1 pc

OPTIONAL ACCESSORY

Silicon carbide paper	MLP-SZD□□* (for MLP-GP270)	50 pcs/box, select granularity, Ø200mm with adhesive: 120, 180, 240, 400, 600, 800, 1000, 1200, 1500, 2000
	MLP-SZG□□* (for MLP-GP280)	50 pcs/box, select granularity, Ø250mm with adhesive: 120, 180, 240, 400, 600, 800, 1000, 1200, 1500, 2000
Polishing cloth	MLP-CT6 (for MLP-GP270)	15 pcs/box, Ø200mm with adhesive, long velvet silk material
	MLP-CT7 (for MLP-GP280)	15 pcs/box, Ø250mm with adhesive, long velvet silk material
Diamond polishing liquid	MLP-DLA□□*	500ml, select granularity (µm): W40, W28, W20, W14, W9, W7, W5, W3.5, W2.5, W1.5, W1.0, W0.5, W0.25
Magnetic pad	MLP-AD1 (for MLP-GP270)	Ø200mm
	MLP-AD2 (for MLP-GP280)	Ø250mm
Anti-stick disc	MLP-DC1 (for MLP-GP280)	Ø200mm
	MLP-DC2 (for MLP-GP280)	Ø250mm

* □□ is granularity specification, for example, code MLP-DLA40 stands for 40µm



GRINDER AND POLISHER (BASIC TYPE) CODE MLP-GP314



- Double wheels, rotation direction can be selected
- Smooth rotation, low noise
- Water cooling device, prevent samples from overheating and destroying structure
- Replaceable silicon carbide paper and polishing cloth for grinding and polishing process



silicon carbide paper
(included)

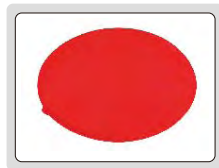

polishing cloth (included)



anti-stick disc (optional)



magnetic pad (optional)

SPECIFICATION

Wheel diameter	Ø203mm
Wheel rotation speed	0~1400r/min (stepless adjustable)
Wheel rotation direction	clockwise or counterclockwise
Power supply	AC 220V, 50Hz
Input power	0.75kW
Dimension	755×700×310mm
Weight	50kg

STANDARD DELIVERY

Main unit	1 pc
Silicon carbide paper	5 pcs each (240, 400, 800, 1200), 20 pcs in total
Polishing cloth	4 pcs
Polishing agent	1 pc (W2.5, 500ml)

OPTIONAL ACCESSORY

Silicon carbide paper	MLP-SZD□□ *	50 pcs/box, select granularity: 120, 180, 240, 400, 600, 800, 1000, 1200, 1500, 2000
Polishing cloth	MLP-CT6	15 pcs/box, long velvet silk material
Diamond polishing liquid	MLP-DLA□□ *	500ml, select granularity (µm): W40, W28, W20, W14, W9, W7, W5, W3.5, W2.5, W1.5, W1.0, W0.5, W0.25
Magnetic pad	MLP-AD1	Ø203mm
Anti-stick disc	MLP-DC1	Ø203mm

* □□ is granularity specification, for example, code **MLP-DLA40** stands for 40µm

MOUNTING PRESSES (ADVANCED TYPE)



MLP-MP43



MLP-MP53

- Built-in heating and cooling structure reduces the mounting time to 6 minutes
- The programmed control system reserves 10 customized preparation schemes to meet different mounting requirements
- The thickness of the middle mold is up to 15mm, and 2 samples can be mounted at the same time at one station
- Can accurately control the pressure size, adjustment range: 1~20MPa



hot mounting resin (included)

SPECIFICATION

Code	MLP-MP43	MLP-MP53
Station number	1	2
Power	1100W+heating power *	1200W+heating power×2
Mounting diameter	Ø30mm (customizable Ø25, Ø40, Ø50mm)	
System pressure	1~20MPa, optional increase or decrease 1MPa	
Pressure mode	automatic electro-hydraulic	
Cooling mode	automatic water cooling **	
Heating range	90~200°C	
Holding time	0~10min	
Cooling temperature/time	40~90°C/0~10min	
Power supply	AC 220V, 50Hz	
Dimension	530×485×463mm	671×485×463mm
Weight	44kg	77kg

* Heating power of mounting sleeve: 1800W (mounting diameter≤31.8mm), 2400W (mounting diameter≥38.1mm)

** Cooling water pressure should not be higher than 1MPa, must be filtered through 40µm filter

STANDARD DELIVERY

Main unit	1 pc
Hot mounting resin	1 bottle (250g)
Funnel	1 pc
Filter	1 pc
Vacuum cleaner tip	1 pc

OPTIONAL ACCESSORY

Hot mounting resin (black, 4kg)	MLP-DR3
---------------------------------	---------



MOUNTING PRESS (STANDARD TYPE) CODE MLP-MP30

- Automatic heating, pressuring, cooling and pressure relief
- Water cooling system



hot mounting resin (optional)



SPECIFICATION

Diameter of workpiece	Ø30mm
Heating temperature range	100~200°C
Delay range	0~999s
Hold time	0~999s
Cooling temperature	20~90°C
Heating power	600W
Power supply	AC 220V, 50Hz
Dimension	350×450×470mm
Weight	45kg

STANDARD DELIVERY

Main unit	1 pc
Hot mounting resin	1 bottle (250g)
Funnel	1 pc

OPTIONAL ACCESSORY

Hot mounting resin (black, 4kg)	MLP-DR3
---------------------------------	---------



MOUNTING PRESS (BASIC TYPE) CODE MLP-MP62

- Suitable for tiny, difficult to handle or irregular metallographic and petrographic samples
- The sample preparation program has three modes: bakelite powder, electric jade powder and user-defined
- The sample preparation program controls the sample preparation time and realizes unattended sample preparation



hot mounting resin (included)



SPECIFICATION

Mounting diameter	Ø30mm (customizable Ø22mm, Ø45mm)
Heating range	room temperature~200°C
Timing range	0~30min
Power	≤800W
Power supply	AC220V, 50Hz
Dimension	440×253×310mm
Weight	32kg

STANDARD DELIVERY

Main unit	1 pc
Hot mounting resin	1 bottle (60g)
Funnel	1 pc

OPTIONAL ACCESSORY

Hot mounting resin (black, 4kg)	MLP-DR3
---------------------------------	---------

VACUUM MOUNTING PRESS CODE MLP-MP25



- Suitable for epoxy resins and cold mosaic compound of polyester castable
- High efficiency, simple and reliable



cold mounting compound
(optional)

SPECIFICATION

Maximum vacuum	-58kPa
Vacuum chamber size	Ø260×125mm
Transposition speed	5r/min
Input power	6W
Power supply	220/110V
Dimension	460×400×403mm
Weight	30kg

STANDARD DELIVERY

Main unit	1 pc
Vacuum pump	1 pc
Ø25mm mold	1 pc
Ø30mm mold	1 pc
Ø40mm mold	1 pc
Ø50mm mold	1 pc
Epoxy resin (400g)	1 pc
Curing agent (200g)	1 pc
Waxed paper tray	10 pcs



OPTIONAL ACCESSORY

Cold mounting compound	MLP-CM1, MLP-CM6
Epoxy resin	MLP-CM3, MLP-CM4

METALLURGICAL MICROSCOPES

REFER TO PAGE
565-567 FOR DETAILS



5102-M600



5108-M3000



5103-M1000

METALLURGICAL ANALYSIS SOFTWARE AND CAMERA

REFER TO PAGE
584-585 FOR DETAILS

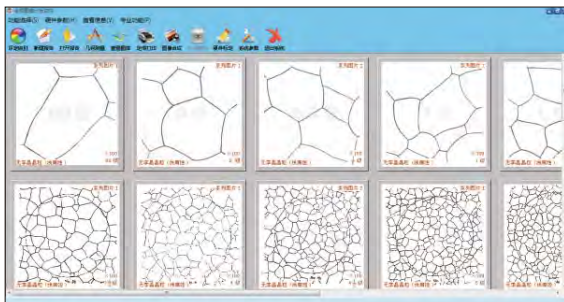

ISM-MAS100C

DIAMOND BLADES



- Specially for precision cutting of carbide, ceramic materials, optical glass and other brittle metal materials

Code	Description	Specification (mm)
MLP-DQ1	1. saw blade is made of edge electroplating 2. used for small workpieces made of crystal, ceramic, glass and alloy materials	Ø100×0.4×12.7
MLP-DQ2		Ø150×0.5×12.7
MLP-DQ3	1. saw blade is made of edge sintering technology 2. used for hard alloy, ceramic, optical glass and other brittle metal materials	Ø100×0.5×20
MLP-DQ4		Ø200×1×32

CUTTING BLADES



MLP-50Z1

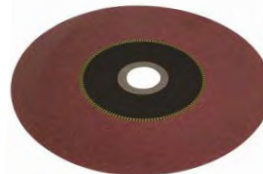

MLP-60Y1

Code	Application	Cutting blade size	Package (pcs/box)
MLP-10R1	1. light non-ferrous metal 2. high toughness metal (Ti) 3. HV hardness value: 0~250	Ø250×1.5×32mm	60
MLP-10R2		Ø250×2×32mm	50
MLP-10R3		Ø300×2×32mm	50
MLP-10R4		Ø350×2.5×32mm	40
MLP-20R1	1. soft ferrous metal 2. HV hardness value: 50~300	Ø250×1.5×32mm	60
MLP-20R2		Ø250×2×32mm	50
MLP-20R3		Ø300×2×32mm	50
MLP-20R4		Ø350×2.5×32mm	40
MLP-30R1	1. medium soft ferrous metal 2. HV hardness value: 120~500	Ø250×1.5×32mm	60
MLP-30R2		Ø250×2×32mm	50
MLP-30R3		Ø300×2×32mm	50
MLP-30R4		Ø350×2.5×32mm	40
MLP-40Z1	1. medium hardness ferrous metal 2. HV hardness value: 180~600	Ø250×1.5×32mm	60
MLP-40Z2		Ø250×2×32mm	50
MLP-40Z3		Ø300×2×32mm	50
MLP-40Z4		Ø350×2.5×32mm	40
MLP-50Z1	1. hard ferrous metal 2. HV hardness value: 180~700	Ø250×1.5×32mm	60
MLP-50Z2		Ø250×2×32mm	50
MLP-50Z3		Ø300×2×32mm	50
MLP-50Z4		Ø350×2.5×32mm	40
MLP-50Z5		Ø400×3×32mm	25
MLP-50Z6		Ø450×3.2×32mm	25
MLP-50Z7		Ø509×4×38.1mm	10
MLP-50Z8		Ø610×4×38.1mm	10
MLP-60Y1	1. high hardness ferrous metal 2. HV hardness value: 250~900	Ø250×1.5×32mm	60
MLP-60Y2		Ø250×2×32mm	50
MLP-60Y3		Ø300×2×32mm	50
MLP-60Y4		Ø350×2.5×32mm	40

- Cutting surfaces are bright and smooth without burning

CUTTING COOLANT

- Free of mineral oil and sodium nitrite, suitable for all kinds of metallographic cutting machines
- Harmless to human health and environment



Code	Description	Specification
MLP-OL1	1. fully synthetic concentrate, used for various types of cutting machines, specially for built-in cooling circulatory system models 2. concentrate, dilute 1:20 with water 3. replace regularly, recommended once a month	1L
MLP-OL2		2L
MLP-OL3		4L
MLP-OL4		6L
MLP-OL5		10L
MLP-OL6	1. oily mixture, use directly 2. cut water sensitive materials at low speed (high speed cutting machine is prohibited) 3. replace regularly, recommended once a month	1L
MLP-OL7		4L

HOT MOUNTING RESIN



- Suitable for small sample preparation

Code	Color	Description	Package (barrel)
MLP-DR1	black	for common sample preparation, fast grinding speed	0.5kg
MLP-DR2			1kg
MLP-DR3			4kg
MLP-DR4	black	edge protection type, low shrinkage, sample binding, high hardness, good wear resistance, slow grinding speed	0.5kg
MLP-DR5			1kg
MLP-DR6			4kg
MLP-DR7	black	carbon phenolic polymer, used in highly conductive fields, medium grinding speed	0.5kg
MLP-DR8			1kg
MLP-DR9	red	for common sample preparation, fast grinding speed	0.5kg
MLP-DR10			1kg
MLP-DR11			0.5kg
MLP-DR12	white	for common sample preparation, fast grinding speed	1kg
MLP-DR13			4kg
MLP-DR14			0.5kg
MLP-DR15	green	for common sample preparation, fast grinding speed	1kg
MLP-DR16			4kg
MLP-DR17			0.5kg
MLP-DR18	transparent	transparent, soluble, for sample with size, position, depth and other requirements	1kg
MLP-DR19			4kg

COLD MOUNTING CONSUMABLES



cold mounting resin



curing agent

Code	Description	Package
MLP-CM1	<ol style="list-style-type: none"> 1. cold mounting compound, fast speed/good transparency/low viscosity/high strength 2. for metal processing without heating, pressure and mounting press 3. curing time: 25°C, 25min 4. usage: cold mounting resin 3:curing agent 2 	<ol style="list-style-type: none"> 1. cold mounting resin 1000g 2. curing agent 800ml 3. Ø30mm cold mounting mold 1 pc 4. plastic cup 20 pcs 5. stirring rod 40 pcs, spoon 1 pc
MLP-CM2	<ol style="list-style-type: none"> 1. epoxy resin, low viscosity, good permeability, completely transparent 2. for samples which can not be heated or mounting pressed, like PCB, SMT and other micro-slice samples 3. curing time: 25°C, 5~6h 4. usage: resin liquid 2:curing agent 1 	<ol style="list-style-type: none"> 1. resin liquid 1000ml 2. curing agent 500ml 3. Ø30mm cold mounting mold 1 pc 4. plastic cup 20 pcs 5. stirring rod 40 pcs
MLP-CM3	<ol style="list-style-type: none"> 1. fast epoxy, fast curing products, completely transparent 2. for samples which can not be heated or mounting pressed, like PCB, SMT and other micro-slice samples 3. curing time: 25°C, 1h 4. usage: resin liquid 2:curing agent 1 	<ol style="list-style-type: none"> 1. resin liquid 1000ml 2. curing agent 500ml 3. Ø30mm cold mounting mold 1 pc 4. plastic cup 20 pcs 5. stirring rod 40 pcs
MLP-CM4	<ol style="list-style-type: none"> 1. low viscosity epoxy, good permeability, completely transparent 2. for samples which can not be heated or mounting pressed, like PCB, SMT and other micro-slice samples 3. curing time: 25°C, 3~4h 4. usage: resin liquid 2:curing agent 1 	<ol style="list-style-type: none"> 1. resin liquid 1000ml 2. curing agent 500ml 3. Ø30mm cold mounting mold 1 pc 4. plastic cup 20 pcs 5. stirring rod 40 pcs
MLP-CM5	<ol style="list-style-type: none"> 1. low heat release epoxy, small, shrink, completely transparent 2. for samples which can not be heated or mounting pressed, like PCB, SMT and other micro-slice samples 3. curing time: 25°C, 20~24h 4. usage: resin liquid 3:curing agent 1 	<ol style="list-style-type: none"> 1. resin liquid 1000ml, 2. curing agent 300ml 3. Ø30mm cold mounting mold 1 pc 4. plastic cup 20 pcs, 5. stirring rod 40 pcs
MLP-CM6	<ol style="list-style-type: none"> 1. cold mounting compound, fast speed/ceramics white/low viscosity/high strength 2. for metal processing without heating, pressure and mounting press 3. curing time: 25°C, 25min 4. usage: cold mounting resin 3:curing agent 2 	<ol style="list-style-type: none"> 1. cold mounting resin 1000g 2. curing agent 800ml 3. Ø30mm cold mounting mold 1 pc 4. plastic cup 20 pcs 5. stirring rod 40 pcs, spoon 1 pc

COLD MOUNTING MOLDS

Code	Description	Specification (mm)
MLP-QM1	round soft mold, for cold embedding of epoxy resin, cold mounting resin on metallographic slice specimens	Ø20×18
MLP-QM2		Ø25×18
MLP-QM3		Ø30×18
MLP-QM4		Ø40×23
MLP-QM5		Ø50×23
MLP-QM6	square soft mold, for cold embedding of epoxy resin, cold mounting resin on metallographic slice specimens	55×20×22
MLP-QM7		70×40×22
MLP-QM8	round hard mold, for cold embedding of epoxy resin, cold mounting resin on metallographic slice specimens	Ø25×23
MLP-QM9		Ø30×27
MLP-QM10		Ø32×27
MLP-QM11		Ø40×29



MOUNTING DISCHARGING AGENT



Code	Description	Specifications
MLP-RA	for hot mounting press and cold mounting mold discharging	200ml/bottle

SLICE CLIPS



MLP-QP1



MLP-QP2

Code	Description	Specifications
MLP-QP1	stainless steel roll slice clip, for hot and cold mounting fixing	100 pieces/pack
MLP-QP2	PET roll slice clip, for hot and cold mounting fixing	100 pieces/pack

DIAMOND POLISHING LIQUID

- For surface grinding and polishing of metallographic, lithographic, ferrous and non-ferrous metals, ceramics, composite materials, gems, instruments, optical glass of high finish
- Compared with ordinary polishing agent, under the same grinding and polishing quality, consumption is saved 30%, time is saved 60%



Code	Description	Granularity (µm)	Package/Bottle
MLP-DLA _{□□} *	1. single crystal, water-based, ethylene glycol-based polishing lubricant formulation 2. for general metallographic preparation	40, 30, 28, 20, 14, 10, 9, 7, 6, 5, 3.5, 3, 2.5, 1.5, 1.0, 0.5, 0.25	500ml
MLP-DLB _{□□} *	1. single crystal, water-based, propylene glycol-based polishing lubricant formulation 2. for grinding and polishing of soft and ductile materials	30, 20, 15, 14, 9, 7, 6, 5, 3, 2.5, 1.5, 1.0, 0.5, 0.25	500ml
MLP-DLC _{□□} *	1. single crystal, water-based, propylene glycol-based polishing lubricant formulation 2. for ultra-precision polishing	0.05	500ml
MLP-DLD _{□□} *	1. single crystal, oil-based, solvent-based polishing lubricant formulation 2. for grinding and polishing of soft materials and materials which cannot touch water	20, 14, 9, 7, 5, 3.5, 2.5, 1.5, 1.0, 0.5, 0.25	500ml
MLP-DLE _{□□} *	1. polycrystalline, water-based, propylene glycol based polishing lubricant formula 2. for grinding and polishing of different materials and hardness components	9, 6, 3, 1.0, 0.5, 0.25	500ml
MLP-DLF _{□□} *	1. polycrystalline, water-based, denatured ethanol based polishing lubricant formula 2. for grinding and polishing of materials which cannot touch water	9, 6, 3, 1.0, 0.5, 0.25	500ml

* □□ is granularity specification, for example, code **MLP-DLA40** stands for diamond polishing liquid 40µm granularity



Universal Testing Machines
Page 766-769



Impact Testing Machines
Page 770



Digital Spring Testers
Page 771



Force Gages
Page 772-774



Test Stands For Force Gages
Page 773-777



Dial Tension Gages
Page 777

ELECTRONIC UNIVERSAL TESTING MACHINES

computer and software (included)

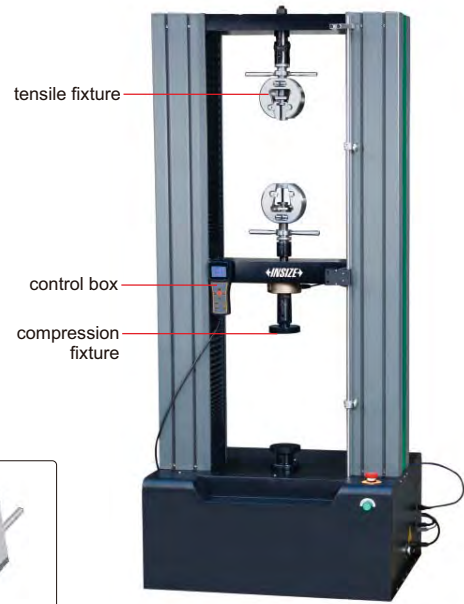
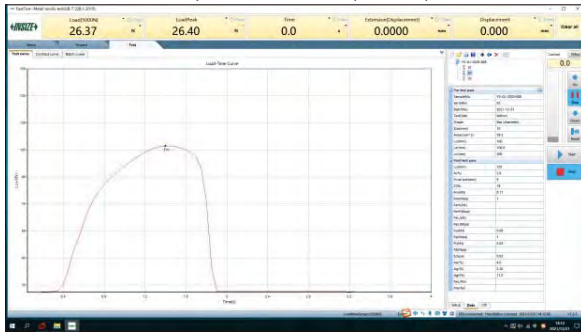

UTM-E50

STANDARD DELIVERY

Main unit	1 pc
Control box	1 pc
Computer	1 pc
Measuring software	1 pc
Printer	1 pc
Wedge tension fixture (including flat jaws and V-shaped jaws) **	1 set
Compression fixture	1 set
Extensometer (only for UTM-E100, UTM-E300)	1 pc



V-shaped jaws (included)



flat jaws (included)

- For tensile, compression, bend, shear, peel, tear tests of metal and non-metal materials

OPTIONAL ACCESSORY

Extensometer

** UTM-E10 does not have V-shaped jaws

SPECIFICATION

Code	UTM-E10	UTM-E50	UTM-E100	UTM-E300
Max. test force	10kN	50kN	100kN	300kN
Accuracy class	0.5 class			
Test force measurement range	0.2%~100%FS			
Test force measurement accuracy	±0.5% of indicating value			
Resolution of test force measurement	1/300000 of Max. test force (same resolution all the way)			
Deformation measurement range	0.2%~100%FS			
Deformation measurement accuracy	±0.5% of indicating value			
Deformation measurement resolution	1/200000 of Max. deformation, up to 1/300000			
Large deformation measurement range	10~800mm			
Large deformation measurement accuracy	±1% of indicating value			
Large deformation measurement resolution	8µm			
Displacement accuracy	±0.5% of indicating value			
Displacement resolution	0.01mm			
Force control speed adjustment range	0.005~5%FS/s			
Force control speed control accuracy	±2% of the set value (speed<0.05%FS/s) ±0.5% of the set value (speed≥0.05%FS/s)			
Deformation speed adjustment range	0.005~5%FS/s			
Deformation speed control accuracy	±2% of the set value (speed<0.05%FS/s) ±0.5% of the set value (speed≥0.05%FS/s)			
Beam displacement speed adjustment range	0.001~500mm/min			
Beam displacement speed control accuracy	±1% of the set value (speed<0.5mm/min) ±0.2% of the set value (speed≥0.5mm/min)			
Crosshead travel *	1030mm	970mm	1250mm	1000mm
Effective compression travel *	800mm	700mm	700mm	600mm
Horizontal test space *	400mm	440mm	600mm	550mm
Power supply	220V, 50Hz, 0.4kW~1kW		380V, 50Hz, 2kW~5kW	
Demension	715×500×1680mm	820×620×1880mm	1070×855×2180mm	1070×920×2550mm
Weight	230kg	350kg	1000kg	1500kg

* Can be customized according to test requirements

ELECTRONIC UNIVERSAL TESTING MACHINES

computer and software (included)

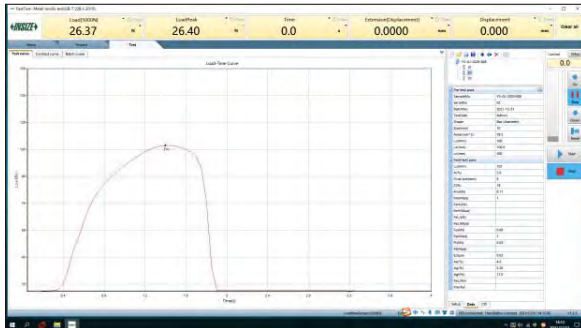

UTM-S5KA

- For tensile, peel, tear tests of metal and non-metal materials

STANDARD DELIVERY

Main unit	1 pc
Control box	1 pc
Computer	1 pc
Measuring software	1 pc
Printer	1 pc
Tensile fixture	1 set

OPTIONAL ACCESSORY

Extensometer

SPECIFICATION

Code	UTM-S200A	UTM-S500A	UTM-S1KA	UTM-S2KA	UTM-S5KA
Max. test force	200N	500N	1kN	2kN	5kN
Accuracy class	0.5 class				
Test force measurement range	0.4%~100%FS				
Test force measurement accuracy	±0.5% of indicating value				
Resolution of test force measurement	1/300000 of Max. test force (same resolution all the way)				
Deformation measurement range	0.2%~100%FS				
Deformation measurement accuracy	±0.5% of indicating value				
Deformation measurement resolution	1/200000 of Max. deformation, up to 1/300000				
Large deformation measurement range	10~800mm				
Large deformation measurement accuracy	±1% of indicating value				
Large deformation measurement resolution	8µm				
Displacement accuracy	±0.5% of indicating value				
Displacement resolution	0.01mm				
Force control speed adjustment range	0.005~5%FS/s				
Force control speed control accuracy	±2% of the set value (speed<0.05%FS/s) ±0.5% of the set value (speed≥0.05%FS/s)				
Deformation speed adjustment range	0.005~5%FS/s				
Deformation speed control accuracy	±2% of the set value (speed<0.05%FS/s) ±0.5% of the set value (speed≥0.05%FS/s)				
Beam displacement speed adjustment range	0.001~500mm/min				
Beam displacement speed control accuracy	±1% of the set value (speed<0.5mm/min) ±0.2% of the set value (speed≥0.5mm/min)				
Crosshead travel*	900mm				
Effective compression travel*	630mm				
Power supply	220V, 50Hz, 0.4kW~1kW				
Demension	510×510×1580mm				
Weight	150kg				

* Can be customized according to test requirements

HYDRAULIC UNIVERSAL TESTING MACHINES

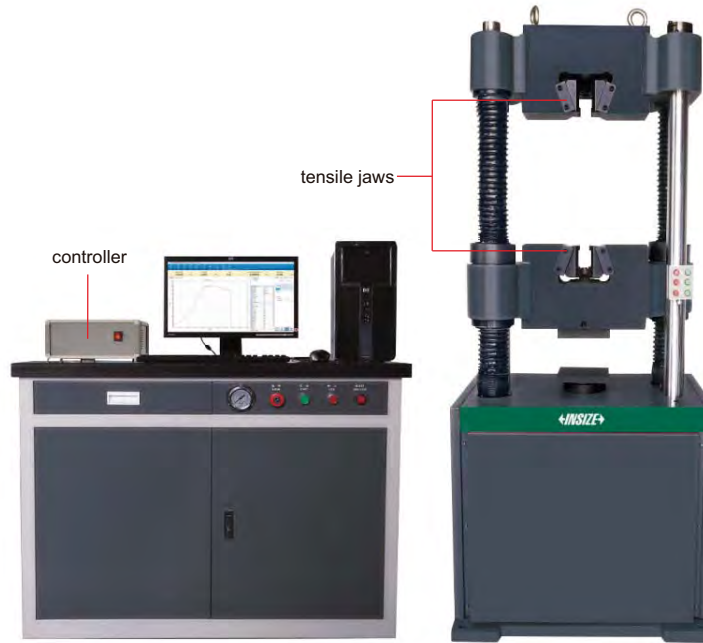

UTM-H300B

- For tensile, compression, bend, shear tests of metal and non-metal materials



SPECIFICATION

Code	UTM-H300B	UTM-H600B	UTM-H1000B	UTM-H2000B	UTM-H3000B	
Max. test force	300kN	600kN	1000kN	2000kN	3000kN	
Accuracy	±1%					
Test force measurement range	2%~100%FS					
Resolution of test force measurement	1/300000 of Max. test force (same resolution all the way)					
Deformation measurement device	extensometer					
Deformation measurement range	1%~100%FS					
Deformation measurement accuracy	±1%					
Deformation measurement resolution	1/300000					
Displacement accuracy	±1%					
Displacement resolution	0.01mm					
Displacement travel	200mm					
Max tensile space (including piston stroke)	600mm	600mm	680mm	600mm	900mm	
Max compression space (including piston stroke)	500mm	500mm	560mm	500mm	800mm	
Transmission mode	chain drive					
Safety protection device	software protection and mechanical limit protection					
Control function	special software, closed-loop of stress, strain and velocity					
Clamping range of round sample	Ø10~32mm	Ø13~40mm	Ø13~60mm	Ø20~70mm	Ø25~80mm	
Clamping range of flat sample	0~15mm	0~15mm*	0~20mm**	0~40mm	0~80mm	
Upper and lower pressure plate size	Ø188mm	Ø188mm	Ø208mm	Ø208mm	Ø208mm	
Bending branch roll width	140mm					
Total power	2.5kW	3.0kW	3.0kW	3.75kW	5.5kW	
Power supply	380V, 50Hz					
Dimension (mm)	host	800×620×1900	820×650×2000	940×780×2250	1100×760×3000	1250×930×3550
	oil source	1140×600×855				
Weight	2T	2.2T	3T	7.5T	12.6T	

* Customizable 0~30mm

** Customizable 0~40mm

To be continued

Continued from previous page

computer and software (included)

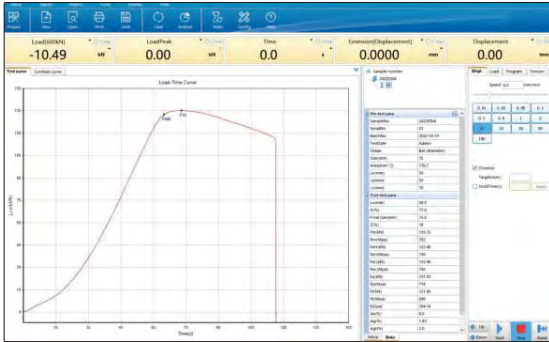

STANDARD DELIVERY

Main unit	1 pc
Electro hydraulic servo oil source	1 pc
Electro hydraulic servo valve	1 pc
High pressure oil pump	1 pc
Oil pressure sensor	1 pc
Control box	1 pc
Extensometer	1 pc
Computer	1 pc
Measuring software	1 set
Printer	1 pc
Tensile fixture	1 set
Compression fixture	1 set



acrylic safety shield (optional)



steel wire safety shield (optional)

OPTIONAL ACCESSORY

Acrylic safety shield	UTM-H-COVER1
Steel wire safety shield	UTM-H-COVER2

EXTENSOMETERS

- Used with universal testing machines

SPECIFICATION

Code	Gage length	Deformation
UTM-EX25-5	25mm	5mm
UTM-EX25-10	25mm	10mm
UTM-EX25-25	25mm	25mm
UTM-EX50-5	50mm	5mm
UTM-EX50-10	50mm	10mm
UTM-EX50-25	50mm	25mm
UTM-EX100-5	100mm	5mm
UTM-EX100-10	100mm	10mm
UTM-EX100-25	100mm	25mm
UTM-EX200-5	200mm	5mm
UTM-EX200-10	200mm	10mm
UTM-EX200-25	200mm	25mm
UTM-EX-B	large deformation, customized according to the workpieces	

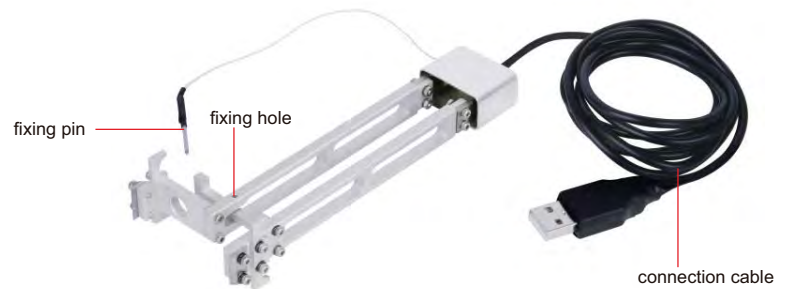

UTM-EX50-10

SEMI-AUTOMATIC IMPACT TESTING MACHINE CODE ITM-S300J

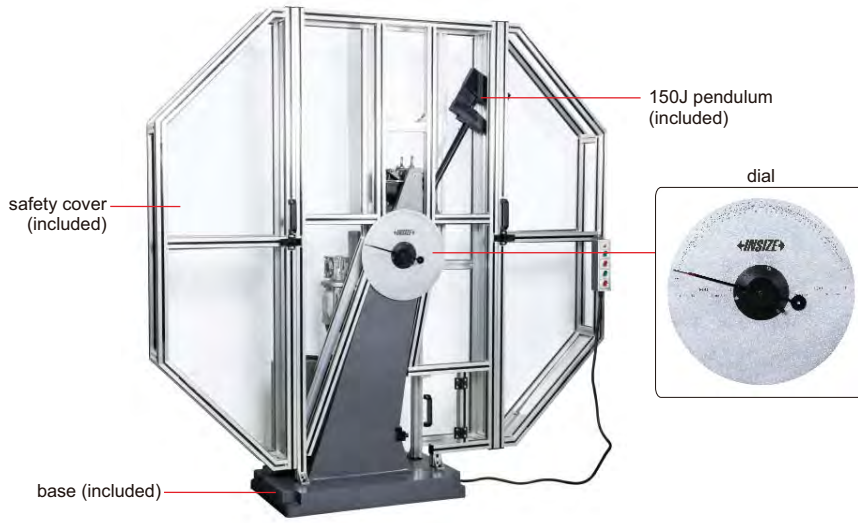

300J pendulum (included)



span aligner (included)



specimen center aligner (included)

software (included)



- According to ISO148
- For testing the anti-impact performance of metal materials under dynamic load
- High-precision bearings, small bearing friction, the impact absorption rate of empty pendulum is less than 0.3%
- Alloy steel impact blade, hardness HRC60
- PLC controller with built-in energy loss correction program
- Supplied with safety cover
- Supplied with software for data storage, automatic processing, etc.
- Data can be stored in Excel format, output and printed

SPECIFICATION

Impact energy	300J	150J
Dial range	0~300J	0~150J
Dial graduation	2J	1J
Pendulum moment	M=160.7695N.m	M=80.3848N.m
Pendulum preparing angle	150°	
Distance between pendulum shaft center and specimen center	750mm	
Impact speed	5.2m/s	
Span of specimen seat	40mm	
End face radius of specimen seat	R1.0~1.5mm	
Radius of impact blade	R2.0~2.5mm	
Inclination angle of support surface of specimen seat	11°	
Angle of impact blade	30°	
Thickness of impact blade	16mm	
Range of measuring angle	0~360°	
Angle resolution	≤0.06°	
Specimen size	10x10x55mm	
Base size	800x500mm	
Power supply	AC 380V, 50Hz	
Power	400W	
Dimension of main body	2150x640x1400mm	
Weight	420kg	

STANDARD DELIVERY

Main unit	1 pc
150J pendulum	1 pc
300J pendulum	1 pc
Span aligner	1 pc
Specimen center aligner	1 pc
Safety cover	1 set
Computer	1 set
Software	1 set
Printer	1 pc

OPTIONAL ACCESSORY

Workbench	7911-15
-----------	---------



DATA
OUTPUT

DIGITAL SPRING TESTERS

- Peak hold and automatic release function
- Set upper and lower limits, red and green indicator and buzzer alarm
- Automatic conversion of three units: N, kgf, lbf
- Built in printer
- Automatic power off



ISF-S10



ISF-S500



ISF-S1000

SPECIFICATION

Code	ISF-S10	ISF-S20	ISF-S30	ISF-S50	ISF-S100	ISF-S200
Maximum load	10N	20N	30N	50N	100N	200N
Resolution	0.001N	0.002N	0.01N	0.01N	0.02N	0.05N
Range of digital scale	65mm	65mm	65mm	95mm	95mm	95mm
Resolution of digital scale	0.01mm	0.01mm	0.01mm	0.01mm	0.01mm	0.01mm
Disk diameter	Ø30mm	Ø30mm	Ø30mm	Ø49mm	Ø49mm	Ø49mm
Maximum free length of spring	65mm	65mm	65mm	95mm	95mm	95mm
Measuring range of force	5%~100% (maximum load)					
Accuracy of force	±1% (maximum load)					
Data output	RS232					
Power supply	220V, 50/60Hz					
Dimension	300×235×600mm	300×235×600mm	300×235×600mm	300×235×620mm	300×235×620mm	300×235×620mm
Weight	13.2kg	13.2kg	13.2kg	17.3kg	19.1kg	19.1kg

Code	ISF-S300	ISF-S500	ISF-S1000	ISF-S2000	ISF-S5000
Maximum load	300N	500N	1000N	2000N	5000N
Resolution	0.1N	0.1N	0.2N	0.5N	1N
Range of digital scale	95mm	95mm	150mm	150mm	150mm
Resolution of digital scale	0.01mm	0.01mm	0.01mm	0.01mm	0.01mm
Disk diameter	Ø49mm	Ø49mm	Ø108mm	Ø108mm	Ø108mm
Maximum free length of spring	95mm	95mm	200mm	200mm	200mm
Measuring range of force	5%~100% (maximum load)				
Accuracy of force	±1% (maximum load)				
Data output	RS232				
Power supply	220V, 50/60Hz				
Dimension	300×235×620mm	300×235×620mm	490×300×920mm	490×300×920mm	490×300×920mm
Weight	19.1kg	20.8kg	47.5kg	47.5kg	47.5kg

STANDARD DELIVERY

Main unit	1 pc
-----------	------

DIGITAL FORCE GAGES (HIGH ACCURACY)

DATA
OUTPUT

INSPECTION
CERTIFICATE



software flash disk
(included)

printer (optional)



ISF-DF100A
type A



ISF-DF5KA
type B



ISF-DF10KC
type C

- Type A and B can be used for tension and pressure tests, type C is only used for pressure tests
- Peak (max.) and tracking mode
- Units for type A: mN, N, gf, kgf, ozf, lbf, type B: N, kgf, lbf, kN, MPa, type C: N, kgf, lbf, kN, tf, MPa
- Tolerance testing
- 1000 memories
- Automatic power off
- Metal case, touch buttons
- LCD display with backlight
- The display flips over when the bottom faces up
- Overload alarm
- Keyboard signal, can be transmitted to Excel



VIDEO

accessory for type B (included)



flat push tip

adapter

pull clamps

accessory for type A (included)

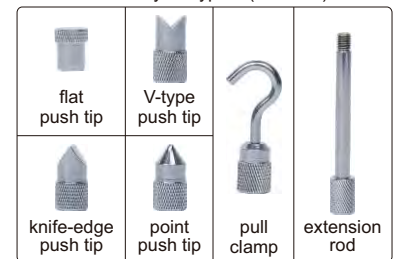

flat
push tip

V-type
push tip

knife-edge
push tip

point
push tip

pull
clamp

extension
rod

SPECIFICATION

Code	ISF-DF5A	ISF-DF10A	ISF-DF20A	ISF-DF50A	ISF-DF100A	ISF-DF200A	ISF-DF500A	ISF-DF1KA
Type	A (internal sensor)							
Load capacity (N)	5	10	20	50	100	200	500	1000
Resolution (N)	0.0005	0.001	0.005	0.005	0.01	0.05	0.05	0.1
Accuracy	±0.2% (of load capacity)							
Power supply	built-in rechargeable battery							

Code	ISF-DF1KB	ISF-DF2KA	ISF-DF5KA	ISF-DF10KA	ISF-DF20KA
Type	B (external sensor)				
Load capacity (N)	1000	2000	5000	10000	20000
Resolution (N)	0.1	0.5	0.5	1	5
Accuracy	±0.2% (of load capacity)				
Power supply	built-in rechargeable battery				

Code	ISF-DF10KC	ISF-DF20KC	ISF-DF50KC	ISF-DF100KC	ISF-DF200KC
Type	C (external sensor)				
Load capacity (kN)	10	20	50	100	200
Resolution (kN)	0.001	0.005	0.005	0.01	0.05
Accuracy	±0.2% (of load capacity)				
Power supply	built-in rechargeable battery				

STANDARD DELIVERY

Main unit	1 pc	
AC/DC adapter	1 pc	
Software and USB cable	1 pc	
Push/pull accessory	type A	6 pcs (flat push tip, V-type push tip, knife-edge push tip, point push tip, pull clamp, extension rod)
	type B	4 pcs (flat push tip, adapter, pull clamps)

OPTIONAL ACCESSORY

Printer	ISF-DF-PRINTER
Test stand	ISF-MT1K

DATA
OUTPUT

INSPECTION
CERTIFICATE

DIGITAL FORCE GAGES



software flash disk
(included)



ISF-1DF100

printer (optional)



VIDEO



accessory (included)

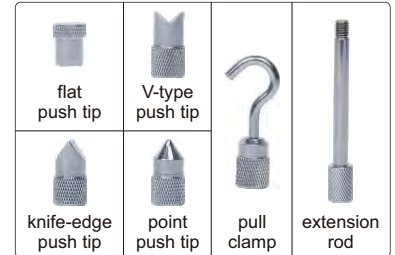

- Push and pull test
- Units: N, gf, kgf, ozf, lbf
- 500 memories
- Automatic power off
- Metal case
- LCD display with backlight
- The display flips over when the bottom faces up
- Overload alarm

SPECIFICATION

Code	ISF-1DF10	ISF-1DF50	ISF-1DF100	ISF-1DF500	ISF-1DF1000
Load capacity (N)	10	50	100	500	1000
Resolution (N)	0.01	0.01	0.1	0.1	1
Accuracy	±0.3% (of load capacity)				
Measuring mode	tracking, peak (max.), tolerance testing				
Power supply	built-in rechargeable battery				
Dimension	150×73×33mm				
Weight	450g				

STANDARD DELIVERY

Main unit	1 pc
AC/DC adapter	1 pc
Software and USB cable	1 pc
Push/pull accessory	6 pcs (flat push tip, V-type push tip, knife-edge push tip, point push tip, pull clamp, extension rod)

OPTIONAL ACCESSORY

Printer	ISF-DF-PRINTER
Test stand	ISF-MT1K

TEST STAND FOR DIGITAL FORCE GAGE CODE ISF-MT1K

- For digital force gages (code ISF-1DF□□□ and ISF-DF□□□)
- To be used in vertical and horizontal orientation

SPECIFICATION

Load capacity	1000N
Travel	200mm (3mm vertical movement per revolution of handwheel)
Dimension	196x250x446mm
Weight	13kg

OPTIONAL ACCESSORY

Digital scale (range: 200mm, resolution: 0.01mm/0.0005")	ISF-MT1K-SCALE
--	----------------

force gage
is optional



VIDEO



digital scale (optional)



horizontal orientation test

FORCE GAGES



ISF-F500

- Push and pull test
- Peak (max.) or tracking mode

accessory (included)

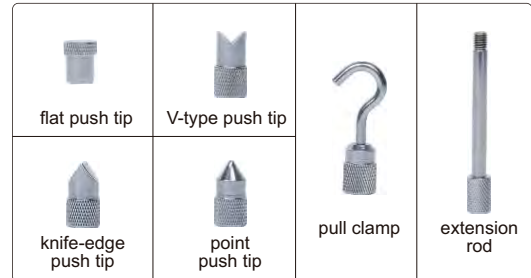

SPECIFICATION

Code		ISF-F10	ISF-F20	ISF-F30	ISF-F50	ISF-F100	ISF-F200	ISF-F300	ISF-F500
Capacity	N	10	20	30	50	100	200	300	500
	kgf	1	2	3	5	10	20	30	50
Graduation	N	0.05	0.1	0.2	0.25	0.5	1	2	2.5
Accuracy		±1% (of load capacity)							

STANDARD DELIVERY

Main unit	1 pc
Push tip	4 pcs (flat, V-type, knife-edge, point)
Pull clamp	1 pc
Extension rod	1 pc

OPTIONAL ACCESSORY

Test stand	ISF-MT500
------------	-----------

TEST STAND FOR FORCE GAGE CODE ISF-MT500



- For force gages (code ISF-F□□□)
- To be used in vertical and horizontal orientation

force gage
is optional



SPECIFICATION

Load capacity	500N
Travel	150mm (3mm vertical movement per revolution of handwheel)
Dimension	160×240×460mm
Weight	12kg

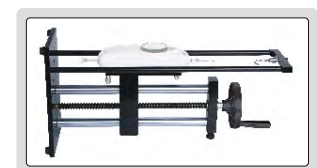

horizontal orientation test



MOTORIZED VERTICAL TEST STAND CODE ISF-RV61

- For digital force gages (code **ISF-1DF** and **ISF-DF**)
- Push and pull test
- Automatic and manual test
- Programmable automatic operation (automatic cycle)
- Four operation modes: displacement cycle (D cycle), force cycle (F cycle), demo (teaching & playback) mode and positioning mode
- Alarm indications: stroke overrange alarm, force overrange alarm, motor block alarm

SPECIFICATION

Load capacity	650N (250lbf, 65kg)
Max. travel	220mm
Resolution of displacement	0.01mm
Accuracy of displacement	±0.3mm
Range of adjustable speed	30~720mm/min
Resolution of speed	1mm/min
Accuracy of speed	±2%
Data output	USB, RS232
Work temperature and relative humidity	10~40°C, 10%~80%RH
Power supply	100~230V
Dimension	340×180×630mm
Weight	15.5kg

digital force gage
is optional



STANDARD DELIVERY

Test stand	1 pc
AC/DC adapter	1 pc
MD8 cable (for force gages)	1 pc
Software and USB cable	1 pc



MOTORIZED HORIZONTAL TEST STAND CODE ISF-RH62

- For digital force gages (code **ISF-1DF** and **ISF-DF**)
- Push and pull test
- Automatic and manual test
- Programmable automatic operation (automatic cycle)
- Four operation modes: displacement cycle (D cycle), force cycle (F cycle), demo (teaching & playback) mode and positioning mode
- Alarm indications: stroke overrange alarm, force overrange alarm, motor block alarm

SPECIFICATION

Load capacity	650N (250lbf, 65kg)
Max. travel	220mm
Resolution of displacement	0.01mm
Accuracy of displacement	±0.3mm
Range of adjustable speed	30~720mm/min
Resolution of speed	1mm/min
Accuracy of speed	±2%
Data output	USB, RS232
Work temperature and relative humidity	10~40°C, 10%~80%RH
Power supply	100~230V
Dimension	671×120×278mm
Weight	13kg

digital force gage
is optional



STANDARD DELIVERY

Test stand	1 pc
AC/DC adapter	1 pc
MD8 cable (for force gages)	1 pc
Software and USB cable	1 pc

MANUAL VERTICAL TEST STANDS FOR FORCE GAGES

ATTENTION:
ONLY FOR PRESS TEST



VIDEO

force gage
is optional



ISF-V10A

- For press test with force gages

SPECIFICATION

Code	ISF-V10A	ISF-V10D
Apply to	dial force gages (code ISF-F□□□)	digital force gages (code ISF-1DF□□□ and ISF-DF□□□)
Load capacity	500N	
Maximum workpiece height	280mm	
Travel	70mm	
Dimension	152×235×425mm	
Weight	10.7kg	

MANUAL HORIZONTAL TEST STANDS FOR FORCE GAGES

ATTENTION:
ONLY FOR PULL TEST



VIDEO

force gage
is optional



ISF-H20A

- For pull test with force gages

SPECIFICATION

Code	ISF-H20A	ISF-H20D
Apply to	dial force gages (code ISF-F□□□)	digital force gages (code ISF-1DF□□□ and ISF-DF□□□)
Load capacity	500N	
Travel	60mm	
Dimension	450×185×170mm	
Weight	9kg	



MANUAL STRIPPING FORCE TEST STANDS

- For stripping force test with force gages

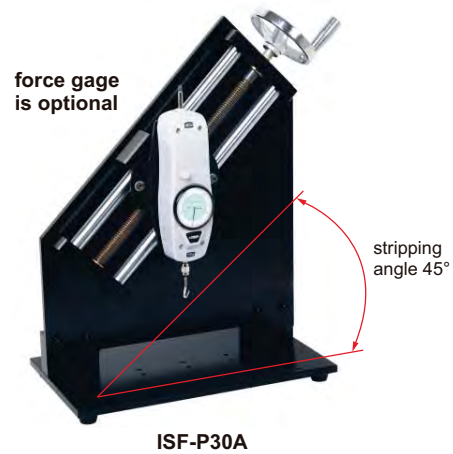

SPECIFICATION

Code	ISF-P30A	ISF-P30D
Apply to	dial force gages (code ISF-F□□□)	digital force gages (code ISF-1DF□□□ and ISF-DF□□□)
Load capacity	500N	
Horizontal travel	170mm	
Dimension	420×215×480mm	
Weight	22kg	

DIAL TENSION GAGES

- Clockwise and counter-clockwise use
- For electronic and precision mechanical industry, such as test the contact pressure of relay, adjust the tension or compression of spring

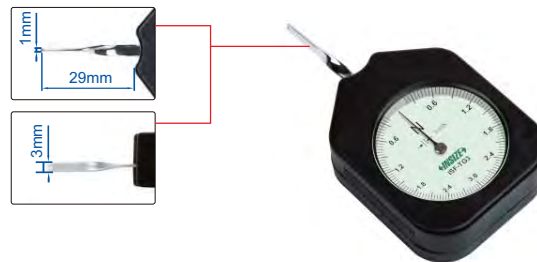

ISF-TG3

SPECIFICATION (Unit: N)

Code	ISF-TGD1	ISF-TGD3	ISF-TGD5	ISF-TG1	ISF-TG1D5	ISF-TG3	ISF-TG5
Range (N)	0.01~0.1	0.03~0.3	0.05~0.5	0.1~1	0.15~1.5	0.3~3	0.5~5
Graduation (N)	0.002	0.005	0.01	0.02	0.025	0.05	0.1
Accuracy	±2% (full scale)						
Dimension (L×W×H)	90×47×19mm						
Weight	60g						

SPECIFICATION (Unit: gf)

Code	ISF-TG10	ISF-TG30	ISF-TG50	ISF-TG100	ISF-TG150	ISF-TG300	ISF-TG500
Range (gf)	1~10	3~30	5~50	10~100	15~150	30~300	50~500
Graduation (gf)	0.2	0.5	1	2	2.5	5	10
Accuracy	±2% (full scale)						
Dimension (L×W×H)	90×47×19mm						
Weight	60g						



Digital Torque Testers
Page 779



Bottle Cap Torque Testers
Page 779



Digital Torque Testers
Page 780-781



Torque Wrench Test Stands
Page 782



Torque Screwdrivers
Page 782-784



Torque Wrenches
Page 785-797



Torque Adapters
Page 798



Torque Multipliers
Page 799-801



DIGITAL TORQUE TESTERS

two display modes

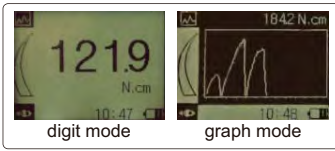

software flash disk (included)

- External sensor
- Metal case, touch buttons
- Clockwise and counter-clockwise operation
- Test mode: track, peak, first peak, preset tolerance
- Unit: N.m, N.cm, kgf.cm, lbf.in, lbf.ft
- Set tolerance with judgement
- 1000 memories
- LCD display with backlight, can automatically turn 180°
- Overload alarm
- Automatic power off

SPECIFICATION

Code	IST-DTT1	IST-DTT5	IST-DTT10
Load capacity	0.05~1N.m	0.25~5N.m	0.5~10N.m
Resolution	0.0001N.m	0.0005N.m	0.001N.m
Max. clamping diameter	Ø10mm	Ø10mm	Ø13mm
Sampling frequency	2000 times per second		
Accuracy	±0.3% (of load capacity)		
Output	USB, RS232, alarm signal		
Power supply	built-in rechargeable battery		
Dimension	145x73x34mm		
Weight	1.4kg		



DATA OUTPUT



VIDEO

STANDARD DELIVERY

Main unit	1 pc
External sensor	1 pc
AC/DC adapter	1 pc
Software and USB cable	1 pc

OPTIONAL ACCESSORY

Printer	ISF-DF-PRINTER
RS232 cable	IST-DTT-CABLE



printer (optional)



DATA OUTPUT

DIGITAL BOTTLE CAP TORQUE TESTERS

- Measure the opening and tightening torque of bottle caps
- Unit: N.m, N.cm, kgf.cm, lbf.in, lbf.ft
- 1500 memories
- Wireless connection to printer
- Automatic power off
- LCD display with backlight
- Overload alarm
- With calibration function



IST-DCT20

SPECIFICATION

Code	IST-DCT2	IST-DCT5	IST-DCT10	IST-DCT20
Load capacity	2N.m	5N.m	10N.m	20N.m
Resolution	0.0002N.m	0.0005N.m	0.001N.m	0.002N.m
Clamping range	Ø19.5~190mm			
Accuracy	±0.5% (of load capacity)			
Measuring mode	tracking, peak (max.), first peak, double peak, tolerance testing			
Output	wireless and USB			
Power supply	built-in rechargeable battery			
Dimension	200×197×142mm			
Weight	2.5kg			

two display modes

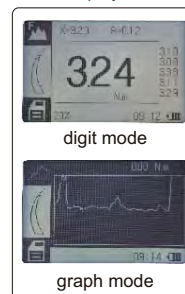

software flash disk (included)



printer (optional)

STANDARD DELIVERY

Main unit	1 pc
AC/DC adapter	1 pc
Software and USB cable	1 pc

OPTIONAL ACCESSORY

Printer	ISH-DS-PRINTER
---------	----------------

DIGITAL TORQUE TESTERS

ATTENTION: NOT SUITABLE FOR ELECTRIC WRENCHES, IMPACT WRENCHES OR PNEUMATIC WRENCHES



IST-04TT350
type A



IST-04TT815
type B

- Test torque wrenches, torque screwdrivers and other torque tools
- Clockwise operation
- Peak, track and first peak working modes
- Tolerance testing
- LED indicator for target torque alarm:
 - Green LED light on when the value is within tolerance;
 - Red LED light on when the value is above the high tolerance
- Power off automatically in 2 minutes without any operations



adaptor
(type A included)

SPECIFICATION

Code	IST-04TT5	IST-04TT28	IST-04TT68	IST-04TT350	IST-04TT815	IST-04TT1000	IST-04TT2000
Type	A				B		
Range	0.5~5N.m	2.8~28N.m	6.8~68N.m	35~350N.m	81.5~815N.m	100~1000N.m	200~2000N.m
Accuracy	±1% (clockwise)						
Resolution	0.001N.m	0.01N.m	0.01N.m	0.1N.m	0.1N.m	1N.m	1N.m
Unit	N.m, in.lb, ft.lb, kg.cm					N.m, ft.lb	
Square socket/hex driver	1/4"	3/8"	3/8"	1/2"	27mm	27mm	27mm
Adaptor	no	3/8" to 1/4"	3/8" to 1/4"	1/2" to 3/8" 3/8" to 1/4"	no		
Power supply	DC						
Weight	0.75kg	0.75kg	1.1kg	1.1kg	5.1kg	5.1kg	5.1kg

STANDARD DELIVERY

Main unit	1 pc
AC/DC adapter	1 pc
Adaptor	refer to details

ATTENTION: NOT SUITABLE FOR ELECTRIC WRENCHES, IMPACT WRENCHES OR PNEUMATIC WRENCHES

DIGITAL TORQUE TESTERS



IST-TT550

- With external sensor, to test torque wrenches, torque screwdrivers and other torque tools
- Clockwise and counter-clockwise operation
- Peak, track and first peak working modes
- Unit: N.m, in.lb, ft.lb, kg.cm
- Tolerance testing
- LED indicator for target torque alarm:
 - Yellow LED light on when the value is below the low tolerance;
 - green LED light on when the value is within tolerance;
 - red LED light on when the value is above the high tolerance
 - The buzzer alarms when the maximum torque value is captured in the first peak mode
- Automatic power off



extension cable (included)



adaptor (included)



with 3 mounting holes on the bottom

SPECIFICATION

Code	IST-TT05	IST-TT5	IST-TT30	IST-TT50	IST-TT220	IST-TT550	IST-TT1000	IST-TT2200
Range	0.1~0.5N.m	0.5~5N.m	3~30N.m	5~50N.m	22~220N.m	55~550N.m	100~1000N.m	220~2200N.m
Accuracy	±1% (clockwise and counter-clockwise)							
Resolution	0.0001N.m	0.0001N.m	0.001N.m	0.001N.m	0.01N.m	0.01N.m	0.1N.m	0.1N.m
Square socket (L)	1/4"	1/4"	3/8"	3/8"	1/2"	3/4"	1"	1"
Power supply	DC							
Adaptor	no	no	3/8" to 1/4"	3/8" to 1/4"	1/2" to 3/8" 3/8" to 1/4"	3/4" to 1/2" 1/2" to 3/8"	1" to 3/4" 3/4" to 1/2" 1/2" to 3/8"	1" to 3/4" 3/4" to 1/2"
Transducer dimension	63×63 ×65mm	63×63 ×65mm	89×89 ×75mm	89×89 ×75mm	109×109 ×83mm	140×140 ×107mm	160×160 ×126mm	160×160 ×126mm
Weight	0.75kg	0.75kg	1.1kg	1.1kg	1.4kg	2.9kg	5.0kg	5.1kg

STANDARD DELIVERY

Main unit	1 pc
Transducer with 1.5m cable	1 pc
Extension cable (1.2m)	1 pc
AC/DC adapter	1 pc
Adaptor	refer to details

TORQUE WRENCH TEST STANDS

application example



adaptor



IST-06TS350



- Rotate the wheel to apply force. Rotary speed is adjustable
- Easy operation due to the gear box
- Used with digital torque testers (IST-TT series)

SPECIFICATION

Code	IST-06TS350	IST-06TS1100	IST-06TS2000
Max. torque value	350N.m	1100N.m	2000N.m
Arm length	197~686mm	380~1350mm	420~1690mm
Dimension	860×290×590mm	1760×350×590mm	2090×350×590mm
Weight	32.5kg	76kg	80kg

Can be customized according to test requirements



digital torque tester (optional)

OPTIONAL ACCESSORY

Digital torque tester	IST-TT series
Adaptor	IST-06TS-BLOCK1 (necessary for IST-TT05, IST-TT5, IST-TT30, IST-TT50 and IST-TT220)
	IST-06TS-BLOCK2 (necessary for IST-TT550, IST-TT1000 and IST-TT2200)

DIGITAL TORQUE SCREWDRIVERS



phillips screwdriver bits (included)



hex screwdriver bits (included)

- Clockwise and counter-clockwise operation
- Unit: cN.m, in.lb, kg.cm
- Peak and track working modes
- Target torque value can be set, with audible and visible alarm:
 - Green LED light on and buzzer sounds when target torque value is 90%~100% of target torque
 - Red LED light on and buzzer sounds when target torque value is reached
- Power off automatically in 5 minutes without any operations

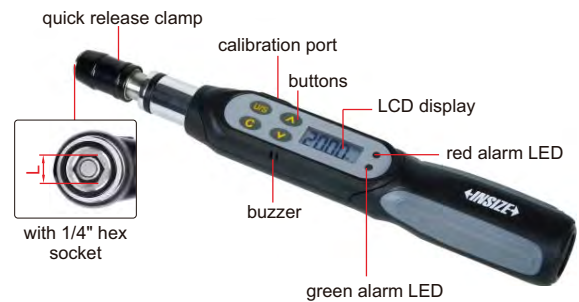

IST-SD200



SPECIFICATION

Code	IST-SD50	IST-SD200	IST-SD400
Range	10~50cN.m	40~200cN.m	80~400cN.m
Accuracy	clockwise	±3%	±2.5%
	counter-clockwise	±4%	±3.5%
Resolution	0.1cN.m	0.1cN.m	0.1cN.m
Size of hex socket (L)	1/4"	1/4"	1/4"
Power supply	1×AAA battery		
Length	193mm	203mm	203mm
Weight	190g	200g	200g

STANDARD DELIVERY

Torque screwdriver	1 pc
Phillips screwdriver bits	1 pc
Hex screwdriver bits	1 pc

OPTIONAL ACCESSORY

Calibration cable	IST-SD-CABLE
-------------------	--------------

BUILT-IN BLUETOOTH



BLUETOOTH DIGITAL TORQUE SCREWDRIVERS (KEYBOARD SIGNAL)



IST-3SD50



IST-3SD200
IST-3SD400

Torque screwdrivers:

- Clockwise and counter-clockwise operation
- Unit: N.m, in.lb, ft.lb, kg.cm
- Peak and track working modes
- Target torque value can be set, with audible and visible alarm:
 - LED lights up in sequence and the buzzer sounds when target torque value is 80%~99.5% of target torque
 - Both green and red LED light on and buzzer sounds when target torque value is reached
- Power off in 2 minutes automatically

Data transmission:

- Built-in Bluetooth module, which can be connected with computers (with Bluetooth function), mobile phones, tablets and other devices
- Keyboard signal, can be transmitted to Excel
- Transmission distance is 10 meters (no obstacles, no electromagnetic interference)
- Bluetooth connection and disconnection are respectively shown by indicator lights

SPECIFICATION

Code	IST-3SD50	IST-3SD200	IST-3SD400
Range	0.1~0.5N.m	0.4~2N.m	0.8~4N.m
Accuracy	clockwise	±3%	±2.5%
	counter-clockwise	±4%	±3.5%
Resolution	0.001N.m	0.001N.m	0.001N.m
Size of hex socket (L)	1/4"	1/4"	1/4"
Power supply	2×AAA batteries		
Length	193mm	193mm	193mm
Weight	304g	304g	383g

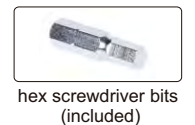

STANDARD DELIVERY

Torque screwdriver	1 pc
Phillips screwdriver bits	1 pc
Hex screwdriver bits	1 pc
Wrench (only for IST-3SD200, IST-3SD400)	1 pc

OPTIONAL ACCESSORY

Calibration cable	IST-SD-CABLE
-------------------	--------------

DIAL TORQUE SCREWDRIVERS

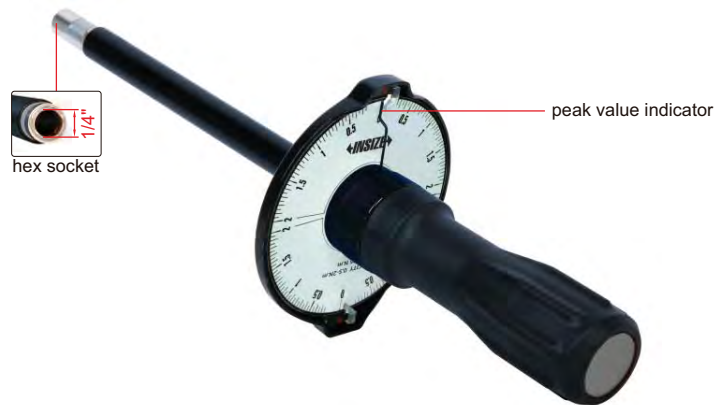

IST-DS2

- Clockwise and counter-clockwise operation
- With peak value indicator

SPECIFICATION

Code	IST-DS02	IST-DS05	IST-DS1	IST-DS2	IST-DS5
Range	0.05~0.2N.m	0.1~0.5N.m	0.2~1N.m	0.5~2N.m	1~5N.m
Graduation	0.005N.m	0.01N.m	0.02N.m	0.05N.m	0.1N.m
Head	1/4" hex socket				
Accuracy	±6%				
Length	152mm	273mm	273mm	273mm	273mm
Weight	170g	400g	400g	400g	400g

TORQUE SCREWDRIVERS

ATTENTION: CLOCKWISE OPERATION ONLY

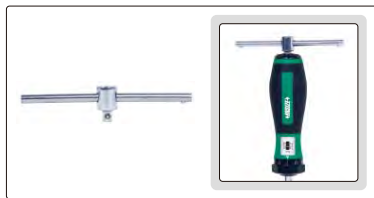

T-bar wrench
(for IST-MG250, IST-MG360, IST-MG600)



IST-MG100

SPECIFICATION

Code	IST-MG100	IST-MG250	IST-MG360	IST-MG600
Range (clockwise)	20~100cN.m	50~250cN.m	60~360cN.m	1.0~6.0N.m
Graduation	2cN.m	5cN.m	5cN.m	0.1N.m
Head	1/4" hex socket			
Accuracy	±6%			
Length	172mm			
Weight	0.26kg			

STANDARD DELIVERY

Torque screwdriver	1 pc
T-bar wrench (for IST-MG250, IST-MG360, IST-MG600)	1 pc



SMALL RANGE DIGITAL TORQUE WRENCH



- Clockwise and counter-clockwise operation
- Unit: N.m, in.lb, ft.lb, kg.cm
- Peak and track working modes
- Target torque value can be set, with audible and visible alarm:
 - Green LED light on and buzzer sounds when target torque value is 90%~100% of target torque
 - Red LED light on and buzzer sounds when target torque value is reached
- Power off automatically in 5 minutes without any operations
- Non-slip grip handle
- With overload record (once the torque reaches 110% of the maximum range)

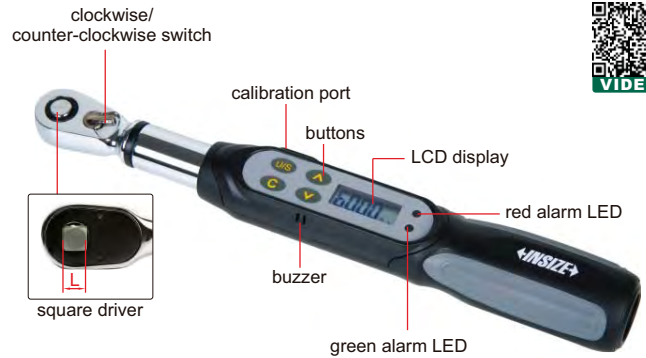

IST-WP6

SPECIFICATION

Code	IST-WP6	
Range	1.2~6N.m	
Accuracy	clockwise	±3%
	counter-clockwise	±4%
Resolution	0.001N.m	
Square driver (L)	1/4"	
Power supply	1×AAA battery	
Length	260mm	
Weight	430g	

OPTIONAL ACCESSORY

Calibration cable	IST-SD-CABLE
-------------------	--------------



SHORT HANDLE DIGITAL TORQUE WRENCHES

- Clockwise and counter-clockwise operation
- Unit: N.m, in.lb, ft.lb, kg.cm
- Peak and track working modes
- Target torque value can be set, with audible and visible alarm:
 - Green LED light on and buzzer sounds when torque value is 90%~100% of target torque
 - Both green and red LED light on and buzzer sounds when target torque value is reached
- Power off in 5 minutes automatically
- Non-slip grip handle
- With damp record
- With overload record (once the torque reaches 110% of the maximum range)



IST-WS60

SPECIFICATION

Code	IST-WS12	IST-WS20	IST-WS30	IST-WS30A	IST-WS60	IST-WS85
Range	2.4~12N.m	4~20N.m	6~30N.m	6~30N.m	12~60N.m	17~85N.m
Accuracy	clockwise	±3%				
	counter-clockwise	±4%				
Resolution	0.01N.m	0.01N.m	0.01N.m	0.01N.m	0.01N.m	0.1N.m
Square driver (L)	1/4"	1/4"	1/4"	3/8"	3/8"	3/8"
Power supply	2×AAA batteries					
Length	215mm	215mm	215mm	215mm	225mm	271mm
Weight	750g	750g	750g	830g	917g	1000g

OPTIONAL ACCESSORY

Calibration cable	IST-SD-CABLE
-------------------	--------------

DIGITAL TORQUE WRENCHES



OPTIONAL ACCURACY:
CLOCKWISE: $\pm 1\%$
COUNTER-CLOCKWISE: $\pm 2\%$
ONLY FOR RANGE 6~850N.m

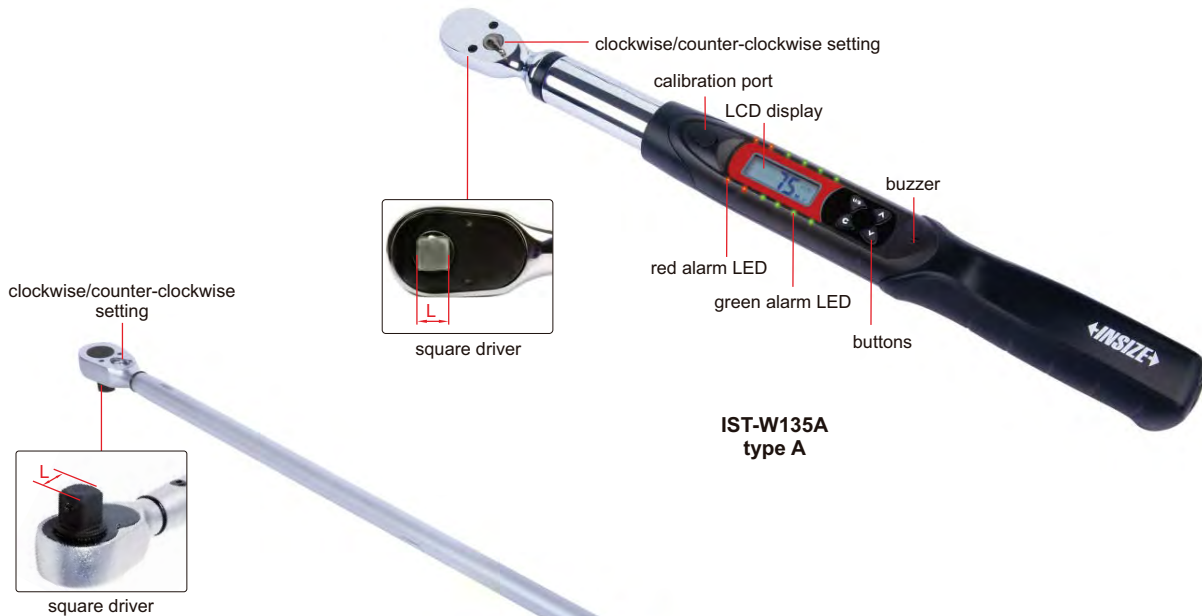

IST-W135A
type A

IST-W1200A
type B

- Clockwise and counter-clockwise operation
- Unit: N.m, in.lb, ft.lb, kg.cm
- Peak and track working mode
- Target torque value can be set, with audible and visible alarm:
 - Green LED light on and buzzer sounds when torque value is 90%~100% of target torque
 - Both green and red LED light on and buzzer sounds when target torque value is reached
- Power off automatically in 5 minutes without any operations
- Non-slip grip handle
- With damp record
- With overload record (once the torque reaches 110% of the maximum range)

SPECIFICATION

Code	Type	Range	Accuracy	Resolution	Square driver (L)	Power supply	Length	Weight
IST-W30A	A	6~30N.m	clockwise: $\pm 2\%$ counter-clock wise: $\pm 3\%$	0.01N.m	1/4"	2×AA batteries, for 110 hours working	390mm	830g
IST-W135A		27~135N.m		0.1N.m	3/8"		415mm	950g
IST-W200A		40~200N.m		0.1N.m	1/2"		530mm	1.4kg
IST-W340A		68~340N.m		0.1N.m	1/2"		650mm	1.6kg
IST-W500A*	B	100~500N.m	clockwise: $\pm 2.5\%$ counter-clock wise: $\pm 3.5\%$	0.1N.m	3/4"		1285mm	7kg
IST-W850A		170~850N.m		0.1N.m	3/4"		1295mm	6kg
IST-W1200A		240~1200N.m		1N.m	1"		1920mm	13kg
IST-W1500A		300~1500N.m		1N.m	1"		1920mm	13kg
IST-W2000A		400~2000N.m		1N.m	1"	1920mm	14kg	

OPTIONAL ACCESSORY

Calibration cable	IST-W-CABLE
-------------------	-------------

* The accuracy of this code is not optional

OPTIONAL ACCURACY:
 CLOCKWISE: $\pm 1\%$
 COUNTER-CLOCKWISE: $\pm 2\%$

INTERCHANGEABLE HEAD DIGITAL TORQUE WRENCHES



IST-2W135A

ratchet head (included)

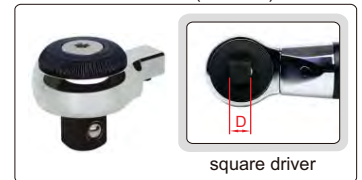

- Clockwise and counter-clockwise operation
- Unit: N.m, in.lb, ft.lb, kg.cm, degree
- Peak and track working modes
- Target torque value can be set, with audible and visible alarm:
 - Green LED light on and buzzer sounds when torque value is 90%~100% of target torque
 - Both green and red LED light on and buzzer sounds when target torque value is reached
- Power off in 5 minutes automatically without any operations
- Non-slip grip handle
- With damp record
- With overload record (once the torque reaches 110% of the maximum range)

torque correction

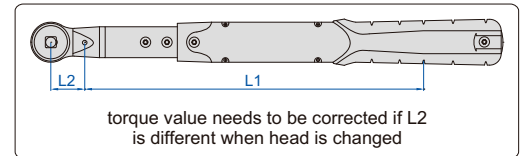

SPECIFICATION

Code	IST-2W30A	IST-2W135A	IST-2W200A	IST-2W340A	IST-2W410A
Range	6~30N.m	27~135N.m	40~200N.m	68~340N.m	82~410N.m
Accuracy	clockwise	$\pm 2\%$			
	counter-clockwise	$\pm 3\%$			
Resolution	0.01N.m	0.1N.m	0.1N.m	0.1N.m	0.1N.m
Socket size (A×B)	12×9mm	12×9mm	18×14mm	18×14mm	18×14mm
Arm length (L1)	272.7mm	287.7mm	381.2mm	501.2mm	501.2mm
Power supply	2xAA batteries, for 110 hours working				
Weight	1400g	1570g	2170g	2320g	2320g

STANDARD DELIVERY

Torque wrench	1 pc
Ratchet head	1 pc

OPTIONAL ACCESSORY

Calibration cable	IST-W-CABLE
Interchangeable head	refer to details

To be continued

Continued from previous page

RATCHET HEAD (INCLUDED) SPECIFICATION

Code of torque wrench	IST-2W30A	IST-2W135A	IST-2W200A	IST-2W340A	IST-2W410A
Square driver (D)	1/4"	3/8"	1/2"	1/2"	3/4"
Length (L2)	29mm	29mm	40mm	40mm	40mm



RATCHET HEAD (optional)

Code	Square driver (D)	Applicable wrenches
IST-2W-R1	1/4"	IST-2W30A
IST-2W-R2	3/8"	IST-2W135A
IST-2W-R3	1/2"	IST-2W135A
IST-2W-R4	1/2"	IST-2W200A IST-2W340A IST-2W410A

ADJUSTABLE SPANNER HEAD (optional)

Code	Open size	Applicable wrenches
IST-2W-A1	5~27mm	IST-2W30A IST-2W135A
IST-2W-A2	5-30mm	IST-2W200A IST-2W410A
IST-2W-A3	10-41mm	IST-2W340A IST-2W410A



OPEN END HEAD (optional)

Code	Open size	Applicable wrenches
IST-2W-K7	7mm	IST-2W30A IST-2W135A
IST-2W-K8	8mm	
IST-2W-K9	9mm	
IST-2W-K10	10mm	
IST-2W-K11	11mm	
IST-2W-K12	12mm	
IST-2W-K13	13mm	
IST-2W-K14	14mm	
IST-2W-K15	15mm	
IST-2W-K16	16mm	
IST-2W-K17	17mm	
IST-2W-K18	18mm	
IST-2W-K19	19mm	
IST-2W-K13A	13mm	
IST-2W-K14A	14mm	
IST-2W-K15A	15mm	
IST-2W-K16A	16mm	
IST-2W-K17A	17mm	
IST-2W-K18A	18mm	
IST-2W-K19A	19mm	
IST-2W-K21A	21mm	
IST-2W-K22A	22mm	
IST-2W-K24A	24mm	
IST-2W-K27A	27mm	

BOX END HEAD (optional)

Code	Open size	Applicable wrenches	
IST-2W-M7	7mm	IST-2W30A IST-2W135A	
IST-2W-M8	8mm		
IST-2W-M10	10mm		
IST-2W-M11	11mm		
IST-2W-M12	12mm		
IST-2W-M13	13mm		
IST-2W-M14	14mm		
IST-2W-M15	15mm		
IST-2W-M16	16mm		
IST-2W-M17	17mm		
IST-2W-M18	18mm		
IST-2W-M19	19mm		
IST-2W-M21	21mm		
IST-2W-M22	22mm		
IST-2W-M13A	13mm		IST-2W200A IST-2W340A
IST-2W-M14A	14mm		
IST-2W-M15A	15mm		
IST-2W-M16A	16mm		
IST-2W-M17A	17mm		
IST-2W-M18A	18mm		
IST-2W-M19A	19mm		
IST-2W-M21A	21mm		

OPTIONAL ACCURACY:
 CLOCKWISE: $\pm 1\%$
 COUNTER-CLOCKWISE: $\pm 2\%$
 ONLY FOR RANGE 6~340N.m

MEASURE THE TORQUE OF TIGHTENED BOLTS

INSPECTION CERTIFICATE

QUALITY INSPECTION TORQUE WRENCHES

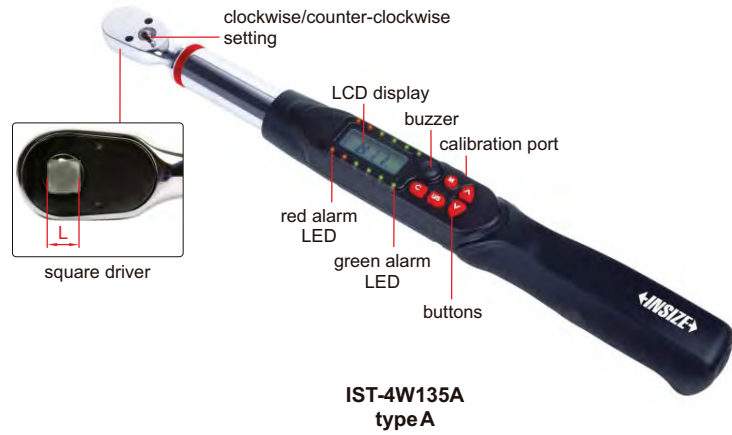

IST-4W135A type A

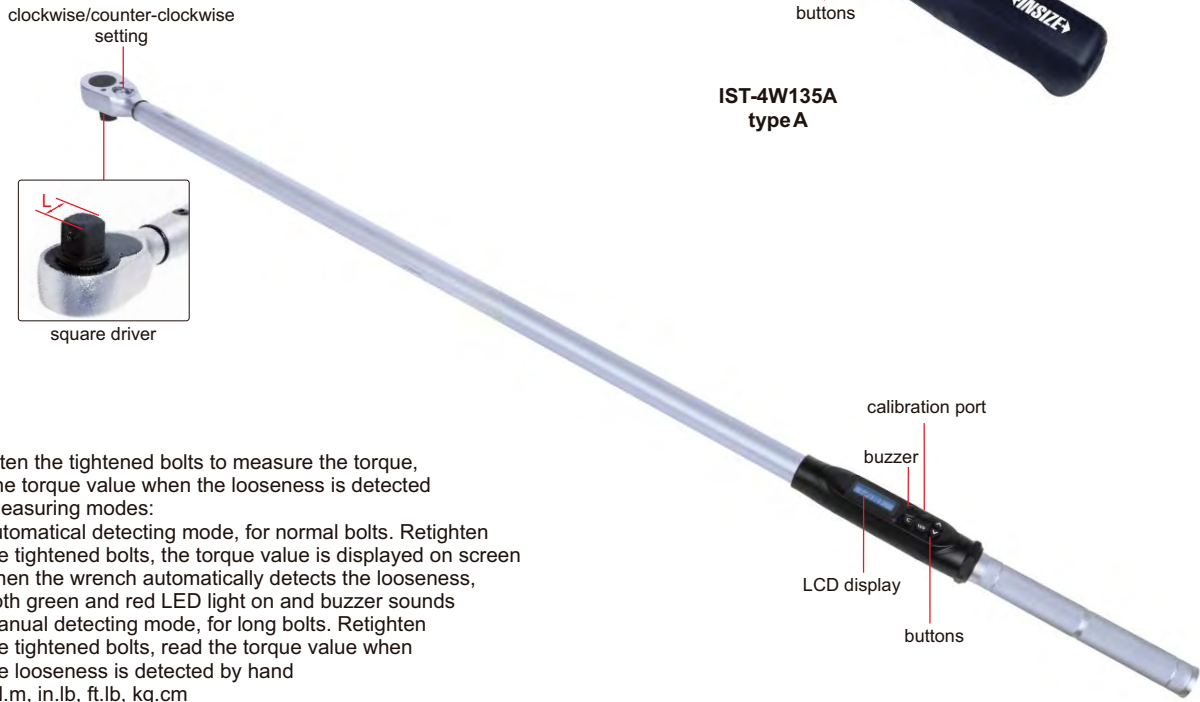

IST-4W1200A type B

- Retighten the tightened bolts to measure the torque, read the torque value when the looseness is detected
- Two measuring modes:
 - M1: automatic detecting mode, for normal bolts. Retighten the tightened bolts, the torque value is displayed on screen when the wrench automatically detects the looseness, both green and red LED light on and buzzer sounds
 - M2: manual detecting mode, for long bolts. Retighten the tightened bolts, read the torque value when the looseness is detected by hand
- Unit: N.m, in.lb, ft.lb, kg.cm
- Peak and track working mode (only for M2 measuring mode)
- Clockwise and count-clockwise operation
- Memory of 50 results
- Power off in 15 minutes automatically
- Non-slip grip handle
- With overload record (once the torque reaches 110% of the maximum range)

SPECIFICATION

Code	Type	Range	Accuracy	Resolution	Square driver (L)	Power supply	Length	Weight
IST-4W30A	A	6~30N.m	clockwise: $\pm 2\%$ counter-clock wise: $\pm 3\%$	0.01N.m	1/4"	2×AA batteries, for 110 hours working	390mm	760g
IST-4W135A		27~135N.m		0.1N.m	3/8"		415mm	940g
IST-4W200A		40~200N.m		0.1N.m	1/2"		530mm	1340g
IST-4W340A		68~340N.m		0.1N.m	1/2"		650mm	1540g
IST-4W850A	B	170~850N.m	clockwise: $\pm 2.5\%$ counter-clock wise: $\pm 3.5\%$	0.1N.m	3/4"		1220mm	6000g
IST-4W1200A		240~1200N.m		1N.m	1"		1800mm	9100g
IST-4W1500A		300~1500N.m		1N.m	1"		1800mm	9100g
IST-4W2000A		400~2000N.m		1N.m	1"		1800mm	10500g

OPTIONAL ACCESSORY

Calibration cable	IST-W-CABLE
-------------------	-------------

TWO-WAY WIRELESS DIGITAL TORQUE WRENCHES

OPTIONAL ACCURACY:
CLOCKWISE: ±1%
COUNTER-CLOCKWISE: ±2%

TRANSMISSION DISTANCE
IS 300 METERS

INSPECTION
CERTIFICATE



IST-13W135A



two-way receiver



Torque wrench:

- The test results can be transmitted wirelessly to the computer and PLC
- Unit: N.m, in.lb, ft.lb, kg.cm
- Clockwise and counter-clockwise operation
- Peak and track working mode
- Can set tolerance with judgement in peak working mode
- 9 target torque values can be set, with audible and visible alarm:
 - Green LED light on and buzzer sounds when torque value is 80%~99.5% of target torque
 - Both green and red LED light on and buzzer sounds when torque value is over 99.5% of target torque
- Power off in 2 minutes automatically
- Non-slip grip handle
- With damp record
- With overload record (once the torque reaches 110% of the maximum range)

Two-way receiver:

- A two-way receiver can be connected with up to 10 wrenches at the same time, and the maximum transmission distance is 300 meters

Software:

- In Windows10 system version 1709 or above
- Two operation mode:
 - Data transmission mode: wrench transmits actual torque value to software after operation
 - Program guidance mode: firstly set process on software (set sequence of tightening, select wrench and set torque values and tolerances). Then software shows which wrench the operator should use (indicator light of the selected wrench is on) and shows the target torque value, and serial number of the screw to be tightened (shows on the wrench); After the operation is finished, the actual torque value is sent to software.
- Can select whether the wrench only sends qualified data after operation (in accordance with the tolerance)
- Two data transmission modes: automatic or press button to send
- When the wrench is disconnected, data is stored in the wrench and automatically sent to computer after wireless connection
- The data in software can be printed or sent to Excel

TWO-WAY RECEIVER SPECIFICATION

Code	IST-13WREC	IST-13WREC-PLC
Signal output to	computer	PLC
Working frequency	ISM433MHz (432.0~433.8MHz, adjustable)	
Power supply	power adapter, 24V, 0.5A	
Dimension	200×108×31mm	
Weight	500g	

OPTIONAL ACCESSORY

Calibration cable	IST-SD-CABLE
-------------------	--------------

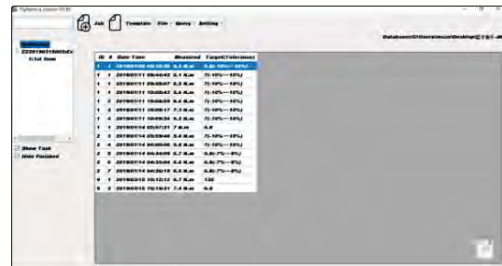

data transmission mode

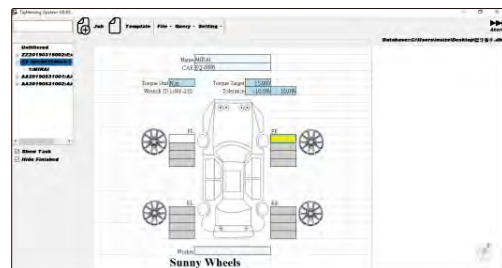

program guidance mode

SPECIFICATION

Code	Range	Accuracy	Unit	Resolution	Square driver (L)	Working frequency	Power supply	Length	Weight
IST-13W30A	6~30N.m	clockwise: ±2% counter-clockwise: ±3%	N-m/ft-lb/ in-lb/kg-cm	0.01N.m	1/4"	ISM433MHz (432.0~433.8MHz, adjustable)	2×AA batteries	390mm	760g
IST-13W60A	12~60N.m			0.01N.m	3/8"			390mm	940g
IST-13W135A	27~135N.m			0.1N.m	3/8"			415mm	940g
IST-13W200A	40~200N.m			0.1N.m	1/2"			530mm	1340g
IST-13W340A	68~340N.m			0.1N.m	1/2"			650mm	1540g
IST-13W1200A	240~1200N.m	clockwise: ±2.5% counter-clockwise: ±3.5%	N-m/ft-lb	1N.m	1"			1800mm	9000g
IST-13W1500A	300~1500N.m			1N.m	1"			1800mm	9000g
IST-13W2000A	400~2000N.m			1N.m	1"			1800mm	10500g

TYPE B OPTIONAL ACCURACY:
CLOCKWISE: $\pm 1\%$
COUNTER-CLOCKWISE: $\pm 2\%$

BUILT-IN BLUETOOTH

BLUETOOTH DIGITAL TORQUE WRENCHES (KEYBOARD SIGNAL)

**INSPECTION
CERTIFICATE**



**IST-15W12A
type A**



**IST-15W135A
type B**

Torque wrenches:

- Unit: in.lb, ft.lb, N.m, kg.cm
- Clockwise and counter-clockwise operation
- Peak and track working mode
- Can set tolerance with judgement in peak working mode
- 9 target torque values can be set, with audible and visible alarm:
LED lights up in sequence, and the buzzer gets louder and louder when torque value is 80%~99.5% of target torque
- Power off in 2 minutes automatically
- Non-slip grip handle
- With overload record (once the torque reaches 110% of the maximum range)

Data transmission:

- Built-in Bluetooth 4.0 module, which can be connected with computers (with Bluetooth function), mobile phones, tablets and other devices
- Keyboard signal, can be transmitted to Excel, Word, TXT
- Transmission distance is 10 meters (no obstacles, no electromagnetic interference)
- Bluetooth connection and disconnection are respectively shown by indicator lights



transmission distance is 10 meters
(no obstacles, no electromagnetic interference)

SPECIFICATION

Code	IST-15W06A	IST-15W12A	IST-15W20A	IST-15W30A	IST-15W135A	IST-15W200A	IST-15W340A
Type	A (short handle)			B (long handle)			
Range	1.2~6N.m	2.4~12N.m	4~20N.m	6~30N.m	27~135N.m	40~200N.m	68~340N.m
Accuracy	clockwise	$\pm 2\%$					
	counter-clockwise	$\pm 3\%$					
Tolerance setting range	-20%~+20% (target torque value)						
Resolution	0.001N.m	0.01N.m	0.01N.m	0.01N.m	0.1N.m	0.1N.m	0.1N.m
Square driver (L)	1/4"	1/4"	1/4"	1/4"	3/8"	1/2"	1/2"
Power supply	2xAAA batteries			2xAA batteries			
Length	215mm	215mm	215mm	390mm	415mm	530mm	650mm
Weight	750g	750g	750g	760g	940g	1340g	1540g

OPTIONAL ACCESSORY

Calibration cable	IST-SD-CABLE
-------------------	--------------

INTERCHANGEABLE HEAD TORQUE WRENCHES

ATTENTION: CLOCKWISE
OPERATION ONLY



IST-11WM200

- According to DIN ISO 6789, ASME B107.300
- All-metal construction, sturdy and durable

SPECIFICATION

Code	Range (clockwise)	Accuracy	Graduation	Socket size (A×B)	Length	Weight
IST-11WM12	2.5~12N.m	±6% (<10N.m) ±4% (≥10N.m)	0.05N.m	12×9mm	284mm	580g
IST-11WM30	6.0~30N.m	±6% (<10N.m) ±4% (≥10N.m)	0.1N.m	12×9mm	303mm	720g
IST-11WM60	10~60N.m	±4%	0.5N.m	12×9mm	372mm	860g
IST-11WM125	25~125N.m	±4%	0.5N.m	12×9mm	427mm	940g
IST-11WM200	40~200N.m	±4%	1N.m	18×14mm	460mm	1060g
IST-11WM335	65~335N.m	±4%	1N.m	18×14mm	520mm	1200g
IST-11WM500	100~500N.m	±4%	2.5N.m	32×24mm	855mm	5000g
IST-11WM800	160~800N.m	±4%	4N.m	32×24mm	1055mm	5900g
IST-11WM1000	200~1000N.m	±4%	5N.m	32×24mm	1055mm	5900g
IST-11WM1500	300~1500N.m	±4%	5N.m	36×27mm	1249mm	9000g
IST-11WM2000	400~2000N.m	±4%	10N.m	36×27mm	1249mm	9000g
IST-11WM3000	600~3000N.m	±4%	15N.m	36×27mm	1249mm	10300g

RATCHET HEAD (optional)



Code	Square driver	Applicable wrenches
IST-11WM-R1	1/4"	IST-11WM12 IST-11WM30
IST-11WM-R2	3/8"	IST-11WM12 IST-11WM30 IST-11WM60 IST-11WM125
IST-11WM-R3	1/2"	IST-11WM200 IST-11WM335
IST-11WM-R4*	3/4"	IST-11WM200 IST-11WM335
IST-11WM-R5	3/4"	IST-11WM500 IST-11WM800 IST-11WM1000
IST-11WM-R6	1"	IST-11WM1500 IST-11WM2000 IST-11WM3000



HOOK HEAD (optional)

Hook head customized according to customer requirements

Continued from previous page



OPEN END HEAD (optional)

Code	Open size	Applicable wrenches
IST-11WM-K8	8mm	IST-11WM12 IST-11WM30 IST-11WM60 IST-11WM125
IST-11WM-K10	10mm	
IST-11WM-K13	13mm	
IST-11WM-K14	14mm	
IST-11WM-K15	15mm	
IST-11WM-K17	17mm	
IST-11WM-K19*	19mm	
IST-11WM-K13A	13mm	IST-11WM200 IST-11WM335
IST-11WM-K14A	14mm	
IST-11WM-K15A	15mm	
IST-11WM-K17A	17mm	
IST-11WM-K19A	19mm	
IST-11WM-K22A	22mm	
IST-11WM-K24A	24mm	
IST-11WM-K27A*	27mm	
IST-11WM-K30A*	30mm	
IST-11WM-K32A*	32mm	
IST-11WM-K22B	22mm	IST-11WM500 IST-11WM800 IST-11WM1000
IST-11WM-K24B	24mm	
IST-11WM-K27B	27mm	
IST-11WM-K28B	28mm	
IST-11WM-K30B	30mm	
IST-11WM-K32B	32mm	
IST-11WM-K33B*	33mm	
IST-11WM-K36B*	36mm	
IST-11WM-K38B*	38mm	
IST-11WM-K40B*	40mm	
IST-11WM-K30C	30mm	IST-11WM1500 IST-11WM2000 IST-11WM3000
IST-11WM-K32C	32mm	
IST-11WM-K34C	34mm	
IST-11WM-K36C	36mm	
IST-11WM-K38C	38mm	
IST-11WM-K41C	41mm	
IST-11WM-K45C	45mm	
IST-11WM-K50C*	50mm	
IST-11WM-K55C*	55mm	
IST-11WM-K60C*	60mm	

BOX END HEAD (optional)

Code	Open size	Applicable wrenches
IST-11WM-M8	8mm	IST-11WM12 IST-11WM30 IST-11WM60 IST-11WM125
IST-11WM-M10	10mm	
IST-11WM-M13	13mm	
IST-11WM-M14	14mm	
IST-11WM-M15	15mm	
IST-11WM-M17	17mm	
IST-11WM-M19	19mm	
IST-11WM-M13A	13mm	IST-11WM200 IST-11WM335
IST-11WM-M14A	14mm	
IST-11WM-M15A	15mm	
IST-11WM-M17A	17mm	
IST-11WM-M19A	19mm	
IST-11WM-M22A	22mm	
IST-11WM-M24A	24mm	
IST-11WM-M27A	27mm	
IST-11WM-M30A	30mm	
IST-11WM-M32A	32mm	
IST-11WM-M22B	22mm	IST-11WM500 IST-11WM800 IST-11WM1000
IST-11WM-M24B	24mm	
IST-11WM-M27B	27mm	
IST-11WM-M28B	28mm	
IST-11WM-M30B	30mm	
IST-11WM-M32B	32mm	
IST-11WM-M33B	33mm	
IST-11WM-M36B*	36mm	
IST-11WM-M38B*	38mm	
IST-11WM-M40B	40mm	
IST-11WM-M30C	30mm	IST-11WM1500 IST-11WM2000 IST-11WM3000
IST-11WM-M32C	32mm	
IST-11WM-M34C	34mm	
IST-11WM-M36C	36mm	
IST-11WM-M38C	38mm	
IST-11WM-M41C	41mm	
IST-11WM-M45C	45mm	
IST-11WM-M50C	50mm	
IST-11WM-M55C*	55mm	
IST-11WM-M60C*	60mm	

*Torque value needs to be corrected for these heads

TORQUE WRENCHES



ATTENTION: CLOCKWISE
OPERATION ONLY



IST-9WM20

- According to DIN ISO 6789, ASME B107.300
- All-metal construction, sturdy and durable

SPECIFICATION

Code	IST-9WM12	IST-9WM20	IST-9WM30	IST-9WM60	IST-9WM100
Range (clockwise)	2.5~12N.m	4~20N.m	6~30N.m	10~60N.m	20~100N.m
Accuracy	±6% (<10N.m) ±4% (≥10N.m)	±6% (<10N.m) ±4% (≥10N.m)	±6% (<10N.m) ±4% (≥10N.m)	±4%	±4%
Graduation	0.1N.m	0.1N.m	0.2N.m	0.5N.m	0.5N.m
Square driver (D)	1/4"	1/4"	3/8"	3/8"	1/2"
Length	290mm	290mm	318mm	388mm	443mm
Weight	680g	680g	820g	960g	1040g

Code	IST-9WM125	IST-9WM200	IST-9WM335	IST-9WM500	IST-9WM800
Range (clockwise)	25~125N.m	40~200N.m	65~335N.m	100~500N.m	160~800N.m
Accuracy	±4%	±4%	±4%	±4%	±4%
Graduation	0.5N.m	1N.m	1N.m	2.5N.m	4N.m
Square driver (D)	1/2"	1/2"	1/2"	3/4"	3/4"
Length	443mm	468mm	528mm	855mm	1055mm
Weight	1040g	1160g	1300g	5000g	5900g

Code	IST-9WM1000	IST-9WM1500	IST-9WM2000	IST-9WM3000
Range (clockwise)	200~1000N.m	300~1500N.m	400~2000N.m	600~3000N.m
Accuracy	±4%	±4%	±4%	±4%
Graduation	5N.m	5N.m	10N.m	15N.m
Square driver (D)	3/4"	1"	1"	1"
Length	1055mm	1260mm	1260mm	1260mm
Weight	5900g	9200g	9200g	10500g



INTERCHANGEABLE HEAD MECHANICAL TORQUE WRENCHES (DIGITAL SETTING)

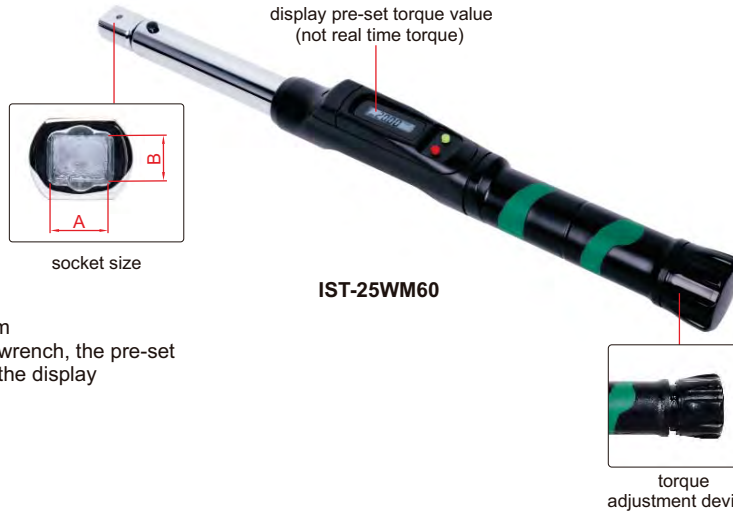

ATTENTION: DISPLAY PRE-SET TORQUE VALUE (NOT REAL TIME TORQUE)

ATTENTION: CLOCKWISE OPERATION ONLY

- Unit: N.m, in.lb, ft.lb, kg.cm
- Mechanical “click” torque wrench, the pre-set torque value is shown on the display

SPECIFICATION

Code	IST-25WM60	IST-25WM100	IST-25WM140	IST-25WM200	IST-25WM300
Range (clockwise)	12~60N.m	20~100N.m	28~140N.m	40~200N.m	60~300N.m
Accuracy	±3%	±3%	±3%	±3%	±3%
Resolution	0.1N.m	0.1N.m	0.1N.m	0.1N.m	0.1N.m
Socket size (A×B)	12×9mm	12×9mm	18×14mm	18×14mm	18×14mm
Length	408mm	431mm	492mm	510mm	568mm
Weight	1.3kg	1.4kg	1.45kg	1.5kg	1.7kg



RATCHET HEAD (optional)

Code	Square driver	Applicable wrenches
IST-11WM-R1	1/4"	IST-25WM60 IST-25WM100
IST-11WM-R2	3/8"	IST-25WM60 IST-25WM100
IST-11WM-R3	1/2"	IST-25WM140 IST-25WM200 IST-25WM300
IST-11WM-R4*	3/4"	IST-25WM140 IST-25WM200 IST-25WM300

BOX END HEAD (optional)

Code	Open size	Applicable wrenches
IST-11WM-M8	8mm	IST-25WM60 IST-25WM100
IST-11WM-M10	10mm	
IST-11WM-M13	13mm	
IST-11WM-M14	14mm	
IST-11WM-M15	15mm	
IST-11WM-M17	17mm	
IST-11WM-M19	19mm	
IST-11WM-M13A	13mm	IST-25WM140 IST-25WM200
IST-11WM-M14A	14mm	
IST-11WM-M15A	15mm	
IST-11WM-M17A	17mm	
IST-11WM-M19A	19mm	
IST-11WM-M22A	22mm	
IST-11WM-M24A	24mm	
IST-11WM-M27A	27mm	
IST-11WM-M30A	30mm	
IST-11WM-M32A	32mm	



HOOK HEAD (optional)

Hook head	customized according to customer requirements
-----------	---

To be continued

Continued from previous page



OPEN END HEAD (optional)

Code	Open size	Applicable wrenches	
IST-11WM-K6	6mm	IST-25WM60 IST-25WM100	
IST-11WM-K7	7mm		
IST-11WM-K8	8mm		
IST-11WM-K9	9mm		
IST-11WM-K10	10mm		
IST-11WM-K11	11mm		
IST-11WM-K12	12mm		
IST-11WM-K13	13mm		
IST-11WM-K14	14mm		
IST-11WM-K15	15mm		
IST-11WM-K16	16mm		
IST-11WM-K17	17mm		
IST-11WM-K18*	18mm		
IST-11WM-K19*	19mm		
IST-11WM-K13A	13mm		IST-25WM140 IST-25WM200 IST-25WM300
IST-11WM-K14A	14mm		
IST-11WM-K15A	15mm		
IST-11WM-K16A	16mm		
IST-11WM-K17A	17mm		
IST-11WM-K18A	18mm		
IST-11WM-K19A	19mm		
IST-11WM-K20A	20mm		
IST-11WM-K21A	21mm		
IST-11WM-K22A	22mm		
IST-11WM-K23A	23mm		
IST-11WM-K24A	24mm		
IST-11WM-K27A*	27mm		
IST-11WM-K30A*	30mm		
IST-11WM-K32A*	32mm		

*Torque value needs to be corrected for these heads

MECHANICAL TORQUE WRENCHES (DIGITAL SETTING)

ATTENTION: CLOCKWISE OPERATION ONLY



ATTENTION: DISPLAY PRE-SET TORQUE VALUE (NOT REAL TIME TORQUE)



IST-19WM100

- Unit: N.m, in.lb, ft.lb, kg.cm
- Mechanical "click" torque wrench, the pre-set torque value is shown on the display

SPECIFICATION

Code	IST-19WM60	IST-19WM100	IST-19WM140	IST-19WM200	IST-19WM300
Range (clockwise)	12~60N.m	20~100N.m	28~140N.m	40~200N.m	60~300N.m
Accuracy	±3%	±3%	±3%	±3%	±3%
Resolution	0.1N.m	0.1N.m	0.1N.m	0.1N.m	0.1N.m
Square driver (D)	3/8"	3/8"	1/2"	1/2"	1/2"
Length	382mm	450mm	481mm	520mm	585mm
Weight	1.3kg	1.4kg	1.45kg	1.6kg	1.8kg

ATTENTION: CLOCKWISE OPERATION ONLY

PRESET TORQUE WRENCHES

- Torque is preset, to prevent adjustment by mistake during use
- The torque is set at the factory before delivery. Customers can also set the torque with torque adjustment tool (**IST-PW-TOOL, optional**) and digital torque testers (**IST-TT□□□, optional**)
- Clockwise operation only



square driver

IST-PW60



torque adjustment tool (optional)

SPECIFICATION

Code	IST-PW12	IST-PW20	IST-PW30	IST-PW60	IST-PW125	IST-PW200
Adjustable range *	2.5~12N.m 22~105in.lb	4~20N.m 36~175in.lb	6~30N.m 55~265in.lb	10~60N.m 8~44ft.lb	25~125N.m 20~90ft.lb	40~200N.m 30~145ft.lb
Accuracy	±3%	±3%	±3%	±3%	±3%	±3%
Square driver (D)	1/4"	1/4"	3/8"	3/8"	3/8"	1/2"
Length	184mm	184mm	214mm	255mm	366mm	457mm
Weight	450g	450g	500g	560g	790g	1200g

Code	IST-PW340	IST-PW500	IST-PW650	IST-PW800	IST-PW1000A	IST-PW1000B
Adjustable range *	65~340N.m 50~250ft.lb	100~500N.m 75~365ft.lb	150~650N.m 110~475ft.lb	160~800N.m 120~585ft.lb	200~1000N.m 150~735ft.lb	200~1000N.m 150~735ft.lb
Accuracy	±3%	±3%	±4%	±4%	±4%	±4%
Square driver (D)	1/2"	3/4"	3/4"	3/4"	3/4"	1"
Length	691mm	910mm	910mm	1037mm	1265mm	1265mm
Weight	1960g	2800g	2800g	5000g	6000g	6000g

OPTIONAL ACCESSORY

Torque adjustment tool **IST-PW-TOOL**

*Adjust to a fixed torque value according to customer requirements before delivery

DIAL TORQUE WRENCHES



square driver

IST-DW70

- Clockwise and counter-clockwise operation
- According to DIN ISO 6789, ASME B107.300

SPECIFICATION

Code	IST-DW1D8	IST-DW3D5	IST-DW9	IST-DW18	IST-DW35	IST-DW70	IST-DW140	IST-DW240	IST-DW350	IST-DW480
Range	0.36~1.8N.m 3~16in.lb	0.7~3.5N.m 6~30in.lb	1.8~9N.m 15~75in.lb	3.6~18N.m 30~150in.lb	7~35N.m 60~300in.lb	14~70N.m 120~600in.lb	28~140N.m 20~100ft.lb	48~240N.m 35~175ft.lb	70~350N.m 50~250ft.lb	96~480N.m 70~350ft.lb
Accuracy	±3%	±3%	±3%	±3%	±3%	±3%	±3%	±3%	±3%	±3%
Graduation	0.02N.m 0.2in.lb	0.05N.m 0.5in.lb	0.1N.m 1in.lb	0.2N.m 2in.lb	0.5N.m 5in.lb	1N.m 10in.lb	2N.m 1ft.lb	3N.m 2.5ft.lb	2.5N.m 2.5ft.lb	6N.m 5ft.lb
Square driver (D)	1/4"	1/4"	1/4"	3/8"	3/8"	3/8"	1/2"	1/2"	1/2"	3/4"
Length	254mm	254mm	254mm	254mm	254mm	378mm	546mm	546mm	546mm	708mm
Weight	480g	480g	480g	480g	480g	820g	1300g	1300g	1300g	4030g

DIGITAL TORQUE ADAPTERS (WITH ANGLE DETECTION)



working with mechanical wrenches



- Clockwise and counter-clockwise operation
- After reaching the desired torque, turn the wrench at a angle to apply extra torque
- Unit: N.m, in.lb, ft.lb, kg.cm, degree
- Peak and track working modes
- Target torque or angle value can be set, with audible and visible alarm:
 - Green LED light on and buzzer sounds when torque or angle value is 80%~100% of target torque or angle
 - Both green and red LED light on and buzzer sounds when target torque or angle value is reached
- Power off in 2 minutes automatically
- Memory 50 measurement values for browsing
- With overload record (once the torque reaches 110% of the maximum range)

IST-5W135A



SPECIFICATION

Code		IST-5W30A	IST-5W135A	IST-5W200A	IST-5W340A
Range	torque	6~30N.m	27~135N.m	40~200N.m	68~340N.m
	angle	0~999°			
Accuracy	clockwise	±3%			
	counter-clockwise	±4%			
	angle	±2° (rotate at 90°)			
Resolution	torque	0.01N.m	0.1N.m	0.1N.m	0.1N.m
	angle	1°			
Square driver (L)		1/4"	3/8"	1/2"	1/2"
Power supply		2xAAA batteries			
Dimension		Ø85×60mm	Ø85×75mm	Ø85×80mm	Ø85×80mm
Weight		150g	220g	240g	240g

OPTIONAL ACCESSORY

Calibration cable	IST-SD-CABLE
-------------------	--------------

DIGITAL ANGLE METER CODE 2177-121

REFER TO PAGE 335 FOR DETAILS





TORQUE MULTIPLIERS



IST-TM2000

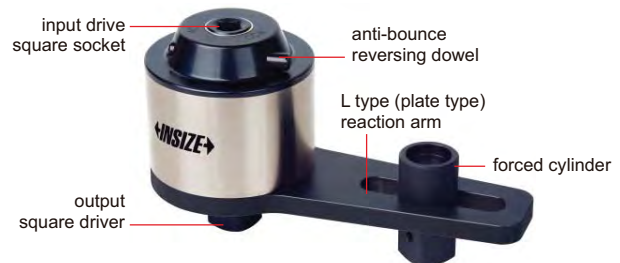
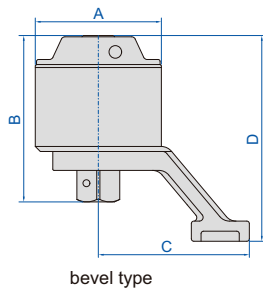

IST-TM3500P

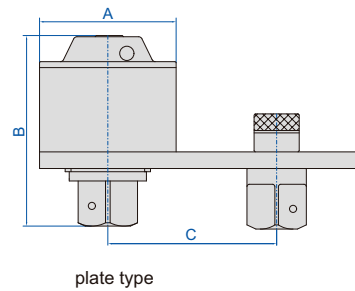

- Input to output accuracy: $\pm 5\%$

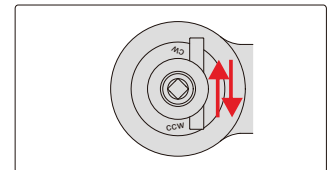

after tightening, toggle the anti-bounce reversing dowel, turn the wrench in the anticlockwise direction, then remove the wrench from torque multiplier

Z TYPE (BEVEL TYPE) TORQUE MULTIPLIER

Code	Capacity	Torque ratio	Square socket	Square driver	Dimension (A×B×C×D)	For bolt	For nut	Weight
IST-TM1000	1000N.m	1:4	1/2"	1"	82x98.5x97x122.4mm	M20~30	S30~46	2.1kg
IST-TM2000	2000N.m	1:13	1/2"	1"	82x120x105x147mm	M22~35	S32~55	3.15kg
IST-TM3500	3500N.m	1:16	1/2"	1"	98x131x120x163mm	M30~45	S46~70	4.9kg
IST-TM5500	5500N.m	1:20.5	1/2"	1 1/2"	115x163.5x137x199mm	M38~52	S55~80	8.1kg
IST-TM7500	7500N.m	1:23	1/2"	1 1/2"	127x173x146x215mm	M42~60	S65~90	10.6kg
IST-TM10000	10000N.m	1:28	1/2"	1 1/2"	141x170x164x238mm	M52~72	S80~105	14kg

L TYPE (PLATE TYPE) TORQUE MULTIPLIER

Code	Capacity	Torque ratio	Square socket	Square driver	Dimension (A×B×C)	For bolt	For nut	Weight
IST-TM1000P	1000N.m	1:4	1/2"	1"	82x91x(76.7~127.3)mm	M20~30	S30~46	2.4kg
IST-TM2000P	2000N.m	1:13	1/2"	1"	82x120x(92.7~129.3)mm	M22~35	S32~55	3.5kg
IST-TM3500P	3500N.m	1:16	1/2"	1"	98x128x(102.7~145.3)mm	M30~45	S46~70	5.0kg
IST-TM5500P	5500N.m	1:20.5	1/2"	1 1/2"	115x157x(134.05~165.95)mm	M38~52	S55~80	8.7kg
IST-TM7500P	7500N.m	1:23	1/2"	1 1/2"	127x168x(139.05~190.95)mm	M42~60	S65~90	11.7kg
IST-TM10000P	10000N.m	1:28	1/2"	1 1/2"	141x186x(144.05~215.95)mm	M52~72	S80~105	15.2kg
IST-TM15000P	15000N.m	1:50	3/4"	2 1/2"	156x246x(155.25~244.75)mm	M60~85	S80~120	24.1kg
IST-TM20000P	20000N.m	1:76	3/4"	2 1/2"	170x264x(163.75~276.25)mm	M72~100	S105~145	27.8kg

SPLINE-TYPE TORQUE MULTIPLIERS

after tightening, toggle the anti-bounce reversing dowel, turn the wrench in the anticlockwise direction, then remove the wrench from torque multiplier

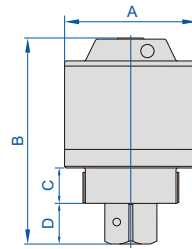
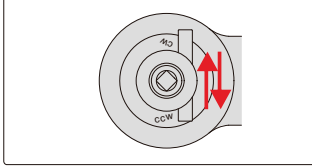

IST-ST2000

- High efficiency gear set with small input torque and large output torque
- Can be installed directly on the workpieces or through different options to form different installation types

application



plate type

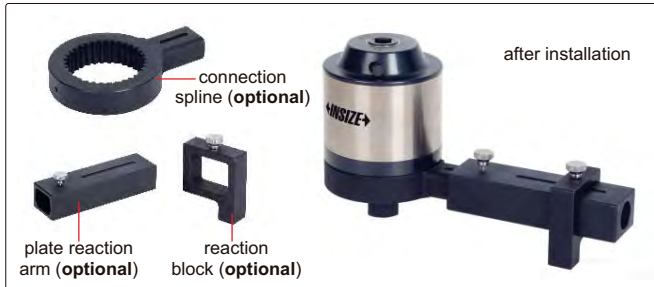

bevel type



SPECIFICATION

Code	Type	Capacity	Accuracy	Torque ratio	Square socket	Square driver	Dimension (A×B×C×D)	For bolt	For nut	Weight				
IST-ST2000	plate	2000N.m	±5%	1:13.3	1/2"	1"	82x135x18x26mm	M22~35	S32~55	3.2kg				
	bevel			1:12										
IST-ST3500	plate	3500N.m		1:16	1/2"	1"								
	bevel			1:15										
IST-ST5500	plate	5500N.m		1:21.5	1/2"	1 1/2"					115x180x29x39mm	M38~52	S55~80	7.8kg
	bevel			1:18.5										
IST-ST7500	plate	7500N.m		1:24	1/2"	1 1/2"								
	bevel			1:20										

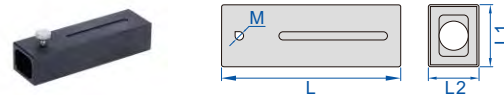
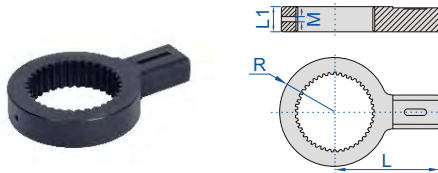

CONNECTION SPLINE (optional)

Code	Dimension (mm)			
	R	L	L1	M
IST-ST2000-C1	41	78	18	5
IST-ST3500-C2	49	95	23	5
IST-ST5500-C3	58	112	28.5	6
IST-ST7500-C4	63.5	123.5	29	6

PLATE REACTION ARM (optional)

Code	Dimension (mm)			
	L	L1	L2	M
IST-ST2000-P1	120	38	25.5	4
IST-ST3500-P2	145	42	32	5
IST-ST5500-P3	150	53	45	6
IST-ST7500-P4	175	60	49	8

To be continued

Continued from previous page

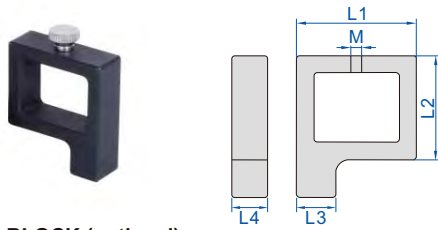

REACTION BLOCK (optional)

Code	Dimension (mm)					
	L	L1	L2	L3	L4	M
IST-ST2000-R1	53.5	52	39.5	15	18	4
IST-ST3500-R2	66	58	48	18	20	5
IST-ST5500-R3	94.5	73	65	22	25	6
IST-ST7500-R4	98	83	72	28	25	8

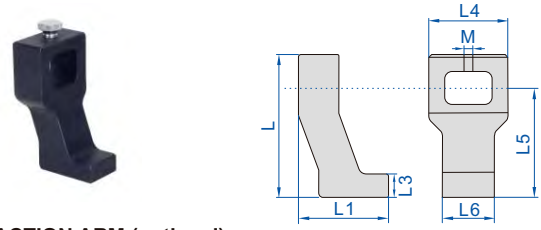

BEVEL REACTION ARM (optional)

Code	Dimension (mm)							
	L	L1	L2	L3	L4	L5	L6	M
IST-ST2000-B1	85	51	18	14	44	60	25	4
IST-ST3500-B2	87.5	52	20	15	50	67	30	5
IST-ST5500-B3	110	70	30	16	59	86	35	6
IST-ST7500-B4	123	78	35	20	68	94	45	6

TWO-USE TORQUE MULTIPLIERS



IST-DT2000

- High efficiency gear set with small input torque and large output torque
- The reaction arm can adjust the position of the applied force according to the operation conditions
- Plate reaction arm and bevel reaction arm are included

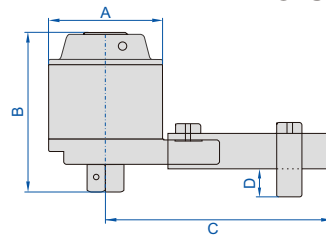
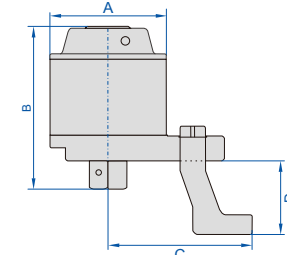
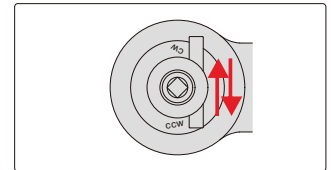

plate type



bevel type

after tightening, toggle the anti-bounce reversing dowel, turn the wrench in the anticlockwise direction, then remove the wrench from torque multiplier



application



plate type



bevel type



SPECIFICATION

Code	Type	Capacity	Accuracy	Torque ratio	Square socket	Square driver	Dimension (A×B×C×D)	For bolt	For nut	Weight
IST-DT2000	plate	2000N.m	±5%	1:13.3	1/2"	1"	82x120x160x21mm	M22~35	S32~55	4.1kg
	bevel			1:12			82x120x93x52mm			
IST-DT3500	plate	3500N.m		1:16	1/2"	1"	98x133x152x26mm	M30~45	S46~70	6.4kg
	bevel			1:15			98x133x117x56mm			
IST-DT5500	plate	5500N.m		1:21.5	1/2"	1 1/2"	115x165x210x39.5mm	M38~52	S55~80	11.4kg
	bevel			1:18.5			115x165x134x72mm			
IST-DT7500	plate	7500N.m		1:24	1/2"	1 1/2"	127x174x243x38mm	M42~60	S65~90	16kg
	bevel			1:20			127x174x146x80mm			



Electronic Balances
Page 803-806



Explosion Proof Electronic Balances
Page 807



Weighing Scales
Page 808/810



Counting Scales
Page 809

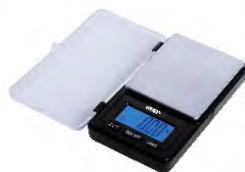

Electronic Pocket Scales
Page 809-810



Platform Scales
Page 811



Floor Scales
Page 812



Electronic Crane Scales
Page 813-815



Moisture Analyzers
Page 816



Weights
Page 817-818

DATA
OUTPUT



ELECTRONIC BALANCES (0.1mg)



8310-320A



calibration weight
(included in 8310-120M,
8310-210M and 8310-320M)



printer (optional)

- Rear electromagnetic sensor
- Separated display unit and weighing unit, reduce vibration error
- Digital processing technology improves reading stability and response speed for micro sample addition, sample weight and balance reading is consistent
- Unit: g, oz, ct, lb
- Weighing, counting, taring, percentage
- Data output

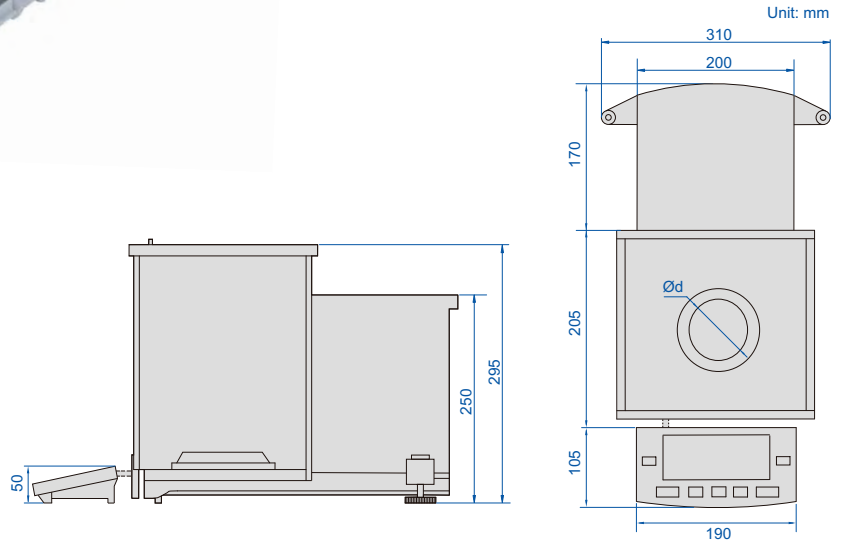

SPECIFICATION

Code	8310-120M	8310-210M	8310-320M	8310-120A	8310-210A	8310-320A
Calibration	external calibration			internal calibration		
Maximum weighing	120g	210g	320g	120g	210g	320g
Minimum weighing	20mg	20mg	20mg	20mg	20mg	20mg
Resolution (d)	0.1mg	0.1mg	0.1mg	0.1mg	0.1mg	0.1mg
Verification interval (e)	1mg	1mg	1mg	1mg	1mg	1mg
Accuracy (m is load)	m≤50g: ±0.5mg; 50g<m≤200g: ±1mg; m>200g: ±1.5mg			m≤50g: ±0.5mg; 50g<m≤200g: ±1mg; m>200g: ±1.5mg		
Repeatability	±0.1mg					
Linearity	±0.1mg					
Stabilization time	2.5s					
Weighing pan size (Ød)	Ø90mm					
Output	RS232					
Operation temperature	10~30°C					
Operation humidity	20~85% RH					
Power supply	power adapter (12V/2A)					
Dimension (L×W×H)	480×310×320mm					
Weight	6kg					

OPTIONAL ACCESSORY

RS232 cable	8304-CABLE *
Printer	8303-PRINTER

*Used to connect with computers

ELECTRONIC BALANCES (0.1mg)

DATA
OUTPUT



8304-120



calibration weight
(included)



printer (optional)

- Electromagnetic sensor
- Unit: g, ct, oz, lb
- Weighing, counting, taring
- Data output

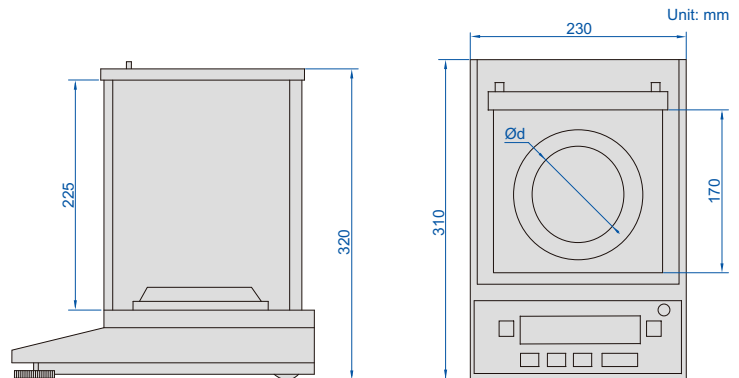

SPECIFICATION

Code	8304-120	8304-220
Maximum weighing	120g	220g
Minimum weighing	10mg	10mg
Resolution (d)	0.1mg	0.1mg
Verification interval (e)	1mg	1mg
Accuracy (m is load)	m≤50g: ±0.5mg; 50g<m≤120g: ±1mg	m≤50g: ±0.5mg; 50g<m≤200g: ±1mg; m>200g: ±1.5mg
Weighing pan size (Ød)	Ø90mm	
Operation temperature	10~30°C	
Operation humidity	20~85% RH	
Power supply	power adapter (12V/2A)	
Dimension (L×W×H)	230×310×320mm	

OPTIONAL ACCESSORY

RS232 cable	8304-CABLE *
Printer	8303-PRINTER

* Used to connect with computers

ELECTRONIC BALANCES (1mg)

DATA
OUTPUT



calibration weight (included)

8303-520

- Aluminum alloy shell, wind shield, three side glass sliding doors
- Electromagnetic balance sensor
- Unit: g, ct, ozt, oz, gn, dwt, mg
- Weighing, counting, taring
- Data output
- With a hook at the bottom

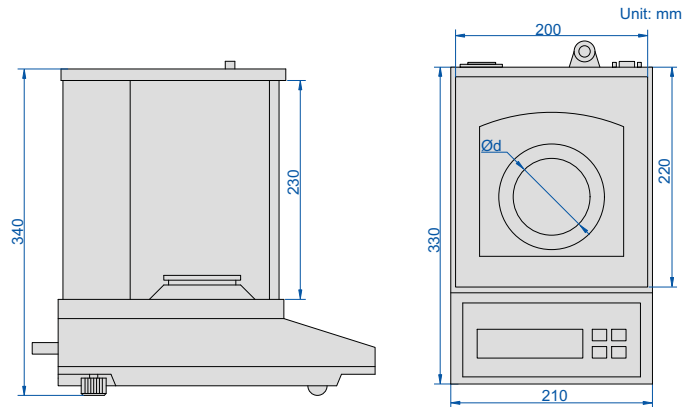

SPECIFICATION

Code	8303-220	8303-320	8303-520	8303-620	8303-1020
Maximum weighing	220g	320g	520g	620g	1020g
Minimum weighing	20mg	20mg	100mg	100mg	100mg
Resolution (d)	1mg	1mg	1mg	1mg	1mg
Verification interval (e)	10mg	10mg	10mg	10mg	10mg
Accuracy	load capacity≤500g: ±5mg; load capacity>500g: ±10mg				
Weighing pan size (Ød)	Ø80mm				Ø120mm
Operation temperature	15~30°C		18~23°C		
Operation humidity	40%~80% RH		50%~70% RH		
Power supply	220V, 50/60Hz				
Dimension (L×W×H)	330×210×340mm				

OPTIONAL ACCESSORY

RS232 cable	8301-CABLE *
Printer	8303-PRINTER



printer (optional)

*Used to connect with computers

ELECTRONIC BALANCES (0.01g)

DATA
OUTPUT



8305-5000

- LCD with back light
- Unit: g, ct, ozt, oz, GN, dwt, lb, kg
- Weighing, counting, taring



calibration weight
(included in 8305-2000
and 8305-3000)

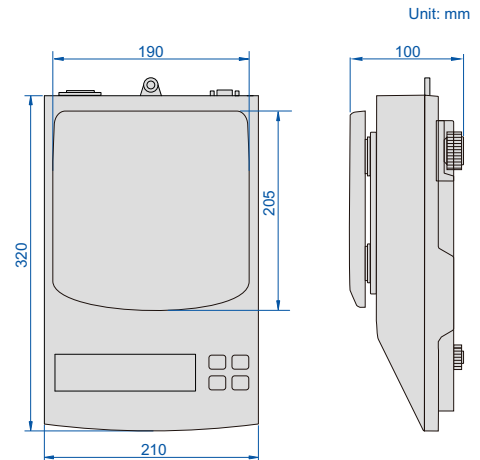

SPECIFICATION

Code	8305-2000	8305-3000	8305-5000	8305-6000
Maximum weighing	2kg	3kg	5kg	6kg
Minimum weighing	0.2g	0.2g	0.2g	0.2g
Resolution (d)	0.01g	0.01g	0.01g	0.01g
Verification interval (e)	0.1g	0.1g	0.1g	0.1g
Accuracy (m is load)	m≤0.5kg: ±0.05g; 0.5kg<m≤2kg: ±0.1g	m≤0.5kg: ±0.05g; 0.5kg<m≤2kg: ±0.1g m>2kg: ±0.15g	m≤0.5kg: ±0.05g; 0.5kg<m≤2kg: ±0.1g m>2kg: ±0.15g	m≤0.5kg: ±0.05g; 0.5kg<m≤2kg: ±0.1g m>2kg: ±0.15g
Weighing pan size	190×205mm			
Output	RS232			
Operation temperature	0~40°C			
Operation humidity	≤80% RH			
Power supply	220V, 50/60Hz			
Dimension (L×W×H)	320×210×100mm			

OPTIONAL ACCESSORY

RS232 cable	8301-CABLE*
Printer	8303-PRINTER

* Used to connect with computers



printer (optional)

DATA
OUTPUT

Ex

EXPLOSION PROOF ELECTRONIC BALANCES



8105-30KG

- LCD display, with backlight
- Zero-setting, subtracting tare value, counting
- Unit: g, ct, oz, lb, ozt

SPECIFICATION

Code	8105-5KG	8105-30KG
Maximum weighing	5kg	30kg
Minimum weighing	0.5g	5g
Resolution (d)	0.01g	0.1g
Verification interval (e)	0.1g	1g
Accuracy (m is load)	m≤0.05kg: ±0.05g; 0.05kg≤m≤0.2kg: ±0.1g; 0.2kg≤m≤5kg: ±0.15g	m≤0.5kg: ±0.5g; 0.5kg≤m≤2kg: ±1.0g; m>2kg: ±1.5g
Dimension of pan	170×170mm	
Output	RS232	
Operation temperature	15~30°C	
Operation humidity	40%~80% RH	
Power	explosion-proof battery, DC7.4V/4.0Ah	
Dimension (L×W×H)	290×185×80mm	

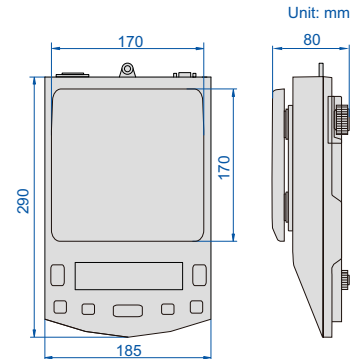

OPTIONAL ACCESSORY

RS232 cable	8105-CABLE*
-------------	-------------

* Used to connect with computers

DATA
OUTPUT

ELECTRONIC BALANCES

- Automatic zero when power on
- Unit: g (gram), ct (carat), ozt (troy ounce)
- Weighing, counting, taring
- Overload alarm
- Data output



8301-3000



windshield
(included in 8301-300,
8301-600 and 8301-1200)



calibration weight
(included in 8301-300,
8301-600 and 8301-1200)

SPECIFICATION

Code	8301-300	8301-600	8301-1200	8301-3000	8301-6000
Maximum weighing	300g	600g	1200g	3000g	6000g
Minimum weighing	0.2g	0.2g	0.2g	2g	2g
Resolution (d)	0.01g	0.01g	0.01g	0.1g	0.1g
Verification interval (e)	0.1g	0.1g	0.1g	1g	1g
Accuracy (m is load)	m≤50g: ±0.05g; 50g<m≤200g: ±0.1g; m>200g: ±0.15g			m≤500g: ±0.5g; 500g<m≤2000g: ±1g; m>2000g: ±1.5g	
Weighing pan size	Ø135mm			190×160mm	
Operation temperature	0~40°C				
Operation humidity	≤80% RH				
Power supply	220V, 50/60Hz				
Dimension (L×W×H)	215×196×62mm				

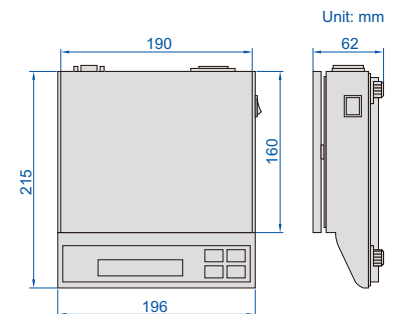

OPTIONAL ACCESSORY

RS232 cable	8301-CABLE
Data output cable (keyboard format)	7302-8001

WEIGHING SCALES (OIML CERTIFICATE)



- LCD display, with backlight
- Zero-setting, subtracting tare value
- Overload alarm
- Automatic power off
- OIML certificate (No. 0200-NAWI-04601)



8002-30M

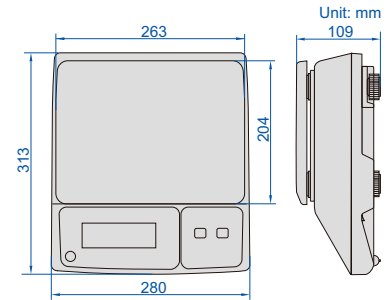

SPECIFICATION

Code	8002-6M	8002-15M	8002-30M	8002-6MD	8002-15MD	8002-30MD
Maximum weighing	3/6kg	6/15kg	15/30kg	3/6kg	6/15kg	15/30kg
Minimum weighing	20g	40g	100g	20g	40g	100g
Resolution (d)	1/2g	2/5g	5/10g	1/2g	2/5g	5/10g
Verification interval (e)	2g	5g	10g	2g	5g	10g
Accuracy (m is load)	m≤3kg: ±1g 3kg<m≤6kg: ±2g	m≤6kg: ±2g 6kg<m≤15kg: ±5g	m≤15kg: ±5g 15kg<m≤30kg: ±10g	m≤3kg: ±1g 3kg<m≤6kg: ±2g	m≤6kg: ±2g 6kg<m≤15kg: ±5g	m≤15kg: ±5g 15kg<m≤30kg: ±10g
Output	no			RS232		
Operation temperature	-10~40°C					
Power	rechargeable battery (6V/3.2Ah), power adapter (12V/500mA)					
Dimensions of pan	263×204mm					

WEIGHING SCALES (HIGH PRECISION)



printer (optional)

- LCD display, with backlight
- Zero-setting, subtracting tare value
- Overload alarm
- Automatic power off



8001-30

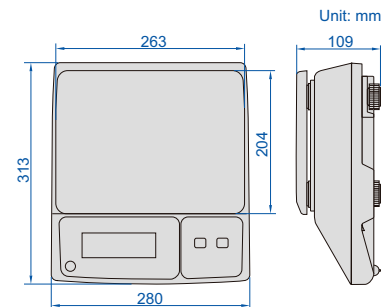

SPECIFICATION

Code	8001-6	8001-15	8001-30	8001-6D	8001-15D	8001-30D
Maximum weighing	6kg	15kg	30kg	6kg	15kg	30kg
Minimum weighing	4g	10g	20g	4g	10g	20g
Resolution (d)	0.2g	0.5g	1g	0.2g	0.5g	1g
Accuracy (m is load)	m≤1kg: ±1g 1kg<m≤4kg: ±2g m>4kg: ±3g	m≤2.5kg: ±2.5g 2.5kg<m≤10kg: ±5g m>10kg: ±7.5g	m≤5kg: ±5g 5kg<m≤20kg: ±10g m>20kg: ±15g	m≤1kg: ±1g 1kg<m≤4kg: ±2g m>4kg: ±3g	m≤2.5kg: ±2.5g 2.5kg<m≤10kg: ±5g m>10kg: ±7.5g	m≤5kg: ±5g 5kg<m≤20kg: ±10g m>20kg: ±15g
Units	kg, lb			kg		
Output	no			RS232		
Operation temperature	-10~40°C					
Power	rechargeable battery (6V/3.2Ah), power adapter (12V/500mA)					
Dimensions of pan	263×204mm					

OPTIONAL ACCESSORY (for scales with RS232)

Printer	8001-PRINTER
Data output cable (keyboard format)	7302-8001

COUNTING SCALES



printer (optional)

- LCD display, with backlight
- Zero-setting, subtracting tare value, counting, accumulation, checking alarm
- Overload alarm
- Units: kg, g, lb, tj, hj, lb-oz



8101-30

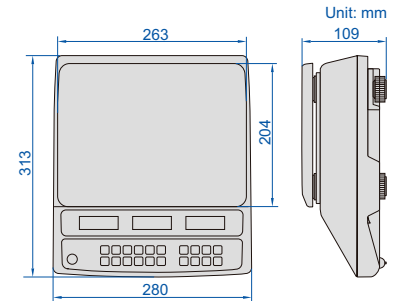

SPECIFICATION

Code	8101-6	8101-15	8101-30	8101-6D	8101-15D	8101-30D
Maximum weighing	6kg	15kg	30kg	6kg	15kg	30kg
Minimum weighing	4g	10g	20g	4g	10g	20g
Resolution (d)	0.2g	0.5g	1g	0.2g	0.5g	1g
Accuracy (m is load)	m≤1kg: ±1g 1kg<m≤4kg: ±2g m>4kg: ±3g	m≤2.5kg: ±2.5g 2.5kg<m≤10kg: ±5g m>10kg: ±7.5g	m≤5kg: ±5g 5kg<m≤20kg: ±10g m>20kg: ±15g	m≤1kg: ±1g 1kg<m≤4kg: ±2g m>4kg: ±3g	m≤2.5kg: ±2.5g 2.5kg<m≤10kg: ±5g m>10kg: ±7.5g	m≤5kg: ±5g 5kg<m≤20kg: ±10g m>20kg: ±15g
Output	no			RS232		
Operation temperature	-10~40°C					
Power	rechargeable battery (6V/3.2Ah), power adapter (12V/500mA)					
Dimensions of pan	263×204mm					

OPTIONAL ACCESSORY (for scales with RS232)

Printer	8001-PRINTER
---------	--------------

ATTENTION:
LOW ACCURACY

ELECTRONIC POCKET SCALE (ECONOMIC TYPE)

- LCD display, with backlight
- Zero-setting, subtracting tare value, counting
- Overload alarm
- Automatic power off



8601-100

SPECIFICATION

Code	8601-100
Maximum weighing	100g
Minimum weighing	0.1g
Resolution (d)	0.01g
Accuracy (m is load)	0.1g≤m≤1g: ±0.03g; 1g<m≤30g: ±0.05g 30g<m≤50g: ±0.07g; m>50g: ±0.14g
Units	g, oz, dwt, ozt
Dimension of pan	55×64mm
Dimension (L×W×H)	108×65×21mm
Operation temperature	-10~40°C
Power supply	2×AAA batteries

use of pan



ELECTRONIC POCKET SCALE (ECONOMIC TYPE)

ATTENTION:
LOW ACCURACY

- LCD display, with backlight
- Zero-setting, subtracting tare value, counting
- Overload alarm
- Automatic power off



8602-200

SPECIFICATION

Code	8602-200
Maximum weighing	200g
Minimum weighing	0.2g
Resolution (d)	0.02g
Accuracy (m is load)	0.2g ≤ m ≤ 2g: ±0.06g; 2g < m ≤ 60g: ±0.1g 60g < m ≤ 100g: ±0.14g; m > 100g: ±0.28g
Units	g, oz, dwt, ozt
Dimension of pan	55×64mm
Dimension (L×W×H)	120×70×17mm
Operation temperature	-10~40°C
Power supply	2×CR2032 batteries

use of pan



WEIGHING SCALES (ECONOMIC TYPE)

- Unit: g, oz, lb, tl



8003-3

SPECIFICATION

Code	8003-3	8003-6	8003-10
Maximum weighing	3kg	6kg	10kg
Minimum weighing	2g	10g	20g
Resolution (d)	0.1g	0.5g	1g
Accuracy	±0.5g	±2.5g	±5g
Weighing pan size	157×157mm		
Operation temperature	5~35°C		
Power supply	2×AAA batteries, power adapter		
Dimension (L×W)	160×225mm		

DATA
OUTPUT

PLATFORM SCALES



8501-AL150



printer (optional)

- LCD large screen display with LED backlight
- Weighing, overweight alarm, counting, keyboard lock, accumulating, auto zero and animal scale
- Unit: kg, g, lb, oz

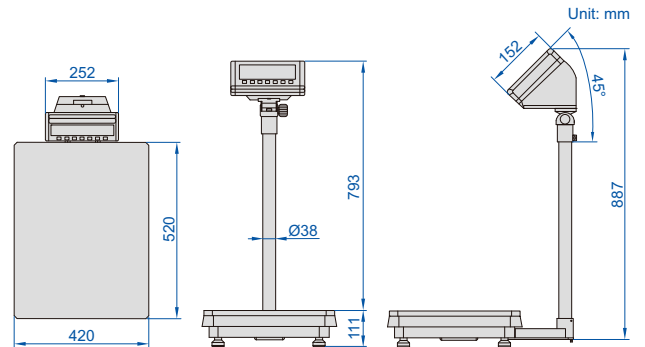

SPECIFICATION

Code	8501-AL60	8501-AL150	8501-AL300
Maximum weighing	60kg	150kg	300kg
Minimum weighing	100g	200g	400g
Resolution (d)	5g	10g	20g
Accuracy	±10g	±20g	±30g
Operation temperature	-10~40°C		
Material	platform: stainless steel, base: die-cast aluminum		
Dimension of platform	420×520mm		
Power	rechargeable lead acid battery (6V/4Ah)		
Output	RS232		
Weight	18.3kg		

OPTIONAL ACCESSORY

Printer	8001-PRINTER
---------	--------------

FLOOR SCALES

DATA OUTPUT



8401-1T1212

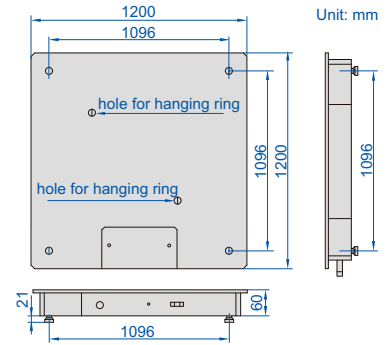

- LCD large screen display with automatic backlight
- Zero, overweight alarm, deduction, unit conversion, accumulating, animal scale, etc.
- Unit: kg, g, lb, oz
- OIML approved load cell

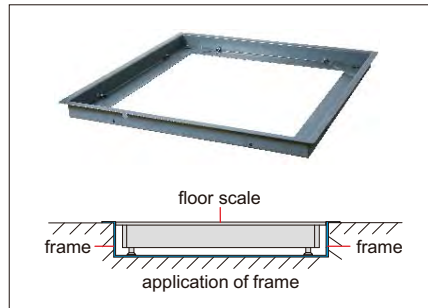

frame (optional)



stand (optional)

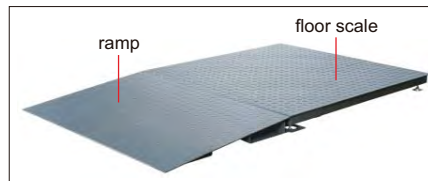

ramp (optional)



printer (optional)

SPECIFICATION

Code	8401-1T1212	8401-2T1212	8401-3T1212
Maximum weighing	1t	2t	3t
Minimum weighing	10kg	20kg	20kg
Resolution (d)	0.5kg	1kg	1kg
Verification interval (e)	0.5kg	1kg	1kg
Accuracy (m is load)	m≤250kg: ±0.25kg; 250kg<m≤1000kg: ±0.5kg	m≤500kg: ±0.5kg; 500kg<m≤2000kg: ±1kg; m>2000kg: ±1.5kg	
Load cell	4 pcs 350Ω		
Operation temperature	-10~40°C		
Material	mild steel		
Dimension of platform	1200×1200mm		
Power	rechargeable lead acid battery (6V/4Ah)		
Output	RS232		
Weight	140kg		

STANDARD DELIVERY

Main unit	1 pc
Indicator	1 pc
AC/DC adapter	1 pc
Stainless steel foot	4 pcs
Hanging ring	2 pcs

OPTIONAL ACCESSORY

Ramp	8401-1212-1
Frame	8401-1212-2
Stand	8401-STAND
Printer	8001-PRINTER

IP65
WATERPROOF

- Dust/waterproof level: IP65
- LED display, remote control
- Low voltage indicator
- Unit: kg, lb
- Automatic power off
- Overload alarm
- 360° safe rotary hook and shackle
- Aluminum alloy die casting case with high strength

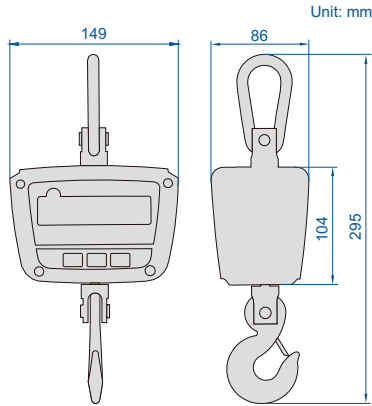

SPECIFICATION

Code	8201-50KG	8201-150KG	8201-300KG
Maximum weighing	50kg	150kg	300kg
Minimum weighing	0.4kg	1.0kg	2.0kg
Resolution (d)	0.02kg/0.01kg	0.05kg/0.02kg	0.10kg/0.05kg
Verification interval (e)	0.02kg	0.05kg	0.10kg
Accuracy	±0.02kg	±0.05kg	±0.10kg
Operation temperature	-10~40°C		
Operation humidity	30%~90% RH		
Overload alarm	100%F.S.+9e		
Maximum safe load	125%F.S.		
Limited overload	400%F.S.		
Power supply	rechargeable battery 6V/3Ah (for 40 hours working)		
Stable reading time	≤8s		

ELECTRONIC CRANE SCALES



STANDARD DELIVERY

Main unit	1 pc
Remote controller	1 pc
Battery charger	1 pc

- LED display, remote control
- Low voltage indicator
- Unit: kg, lb
- Automatic power off
- Overload alarm
- 360° safe rotary hook and shackle
- Plastic case

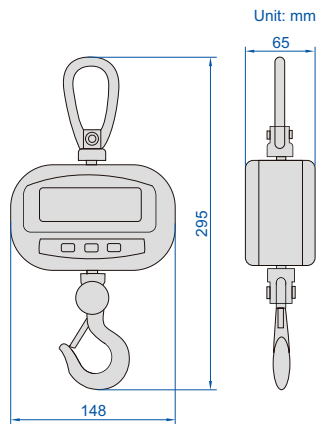

SPECIFICATION

Code	8202-50KG	8202-150KG	8202-300KG
Maximum weighing	50kg	150kg	300kg
Minimum weighing	0.4kg	1.0kg	2.0kg
Resolution (d)	0.02kg/0.01kg	0.05kg/0.02kg	0.10kg/0.05kg
Verification interval (e)	0.02kg	0.05kg	0.10kg
Accuracy	±0.02kg	±0.05kg	±0.10kg
Operation temperature	-10~40°C		
Operation humidity	30%~90% RH		
Overload alarm	100%F.S.+9e		
Maximum safe load	125%F.S.		
Limited overload	400%F.S.		
Power supply	4×1.5V AA batteries (for 40 hours working)		
Stable reading time	≤8s		

ELECTRONIC CRANE SCALES (BASIC TYPE)



STANDARD DELIVERY

Main unit	1 pc
Remote controller	1 pc

ELECTRONIC CRANE SCALES

- Zeroing, taring, weighing
- LED display, remote control
- Low voltage indicator
- Unit: kg, lb
- Overload alarm
- Automatic power off
- Aluminum alloy die casting case with high strength

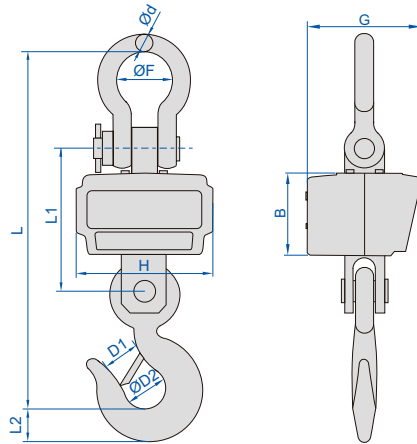

8204-CS3T



remote controller (included)

Code	B	G	H	L	L1	L2	D1	ØD2	Ød	ØF
8204-CS06T	120	163	198	420	190	33	40	47	21	76
8204-CS1T	120	163	198	420	190	33	40	47	21	76
8204-CS2T	120	163	198	420	190	33	50	47	21	76
8204-CS3T	120	163	198	462	196	40	50	50	23	76
8204-CS5T	120	163	198	511	204	47	52	60	26	80
8204-CS10T	135	181	206	589	239	66	52	70	36	90
8204-CS15T	135	181	206	727	257	77	60	85	47	135

SPECIFICATION

Code	8204-CS06T	8204-CS1T	8204-CS2T	8204-CS3T
Maximum weighing	600kg	1000kg	2000kg	3000kg
Minimum weighing	4kg	10kg	20kg	20kg
Resolution (d)	0.2kg/0.1kg	0.5kg/0.2kg	1kg/0.5kg	1kg/0.5kg
Verification interval (e)	0.2kg	0.5kg	1kg	1kg
Accuracy (m is load)	m≤100kg: ±0.1kg; 50kg<m≤200kg: ±0.2kg; m>200kg: ±0.3kg	m≤250kg: ±0.25kg; 250kg<m≤1000kg: ±0.5kg	m≤500kg: ±0.5kg; 500kg<m≤2000kg: ±1kg	m≤500kg: ±0.5kg; 500kg<m≤2000kg: ±1kg; m>2000kg: ±1.5kg
Overload alarm	100%F.S.+9e			
Maximum safe load	150%F.S.			
Limited overload	400%F.S.			
Stable reading time	≤8s			
Power supply	rechargeable battery 6V/4Ah (for 40 hours working)			
Operation temperature	-10~40°C			
Operation humidity	≤85% RH			

Code	8204-CS5T	8204-CS10T	8204-CS15T
Maximum weighing	5000kg	10000kg	15000kg
Minimum weighing	40kg	100kg	100kg
Resolution (d)	2kg/1kg	5kg/2kg	5kg/2kg
Verification interval (e)	2kg	5kg	5kg
Accuracy (m is load)	m≤1000kg: ±1kg; 1000kg<m≤4000kg: ±2kg; m>4000kg: ±3kg	m≤2500kg: ±2.5kg; 2500kg<m≤10000kg: ±5kg	m≤2500kg: ±2.5kg; 2500kg<m≤10000kg: ±5kg; m>10000kg: ±7.5kg
Overload alarm	100%F.S.+9e		
Maximum safe load	150%F.S.		
Limited overload	400%F.S.		
Stable reading time	≤8s		
Power supply	rechargeable battery 6V/4Ah (for 40 hours working)		
Operation temperature	-10~40°C		
Operation humidity	≤85% RH		

To be continued

Continued from previous page

STANDARD DELIVERY

Main unit	1 pc
Remote controller	1 pc
Battery charger	1 pc



handheld display (optional)



large display (optional)

OPTIONAL ACCESSORY

Handheld display	8204-INDICATOR (must be supplied with scales together)
Large display	8204-SCREEN (must be supplied with scales together)

ELECTRONIC CRANE SCALES

- Zeroing, taring, weighing
- LED display, remote control
- Low voltage indicator
- Unit: kg, lb
- Overload alarm
- Automatic power off
- Aluminum alloy die casting case with high strength



8203-CW05T



remote controller (included)

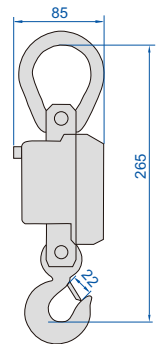
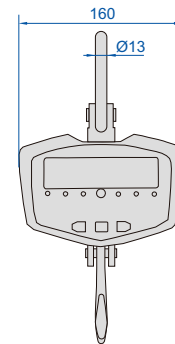

Unit: mm

SPECIFICATION

Code	8203-CW03T	8203-CW05T	8203-CW1T
Maximum weighing	300kg	500kg	1000kg
Minimum weighing	2kg	4kg	10kg
Resolution (d)	0.1kg/0.05kg	0.2kg/0.1kg	0.5kg/0.2kg
Verification interval (e)	0.1kg	0.2kg	0.5kg
Accuracy (m is load)	m≤50kg: ±0.05kg; 50kg<m≤200kg: ±0.1kg; m>200kg: ±0.15kg	m≤100kg: ±0.1kg; 100kg<m≤400kg: ±0.2kg; m>400kg: ±0.3kg	m≤250kg: ±0.25kg; 250kg<m≤1000kg: ±0.5kg
Overload alarm	100%F.S.+9e		
Maximum safe load	150%F.S.		
Limited overload	400%F.S.		
Stable reading time	<10s		
Power supply	3×1.5V AA batteries		
Operation temperature	-10~40°C		
Operation humidity	30%~90% RH		

STANDARD DELIVERY

Main unit	1 pc
Remote controller	1 pc

MOISTURE ANALYZERS

DATA
OUTPUT



8701-RM40



calibration weight
(included)

- LCD screen
- High sensitivity temperature and humidity sensor
- Ring halogen lamp heating evenly, shorten drying time

SPECIFICATION

Code	8701-RM20	8701-RM30	8701-RM40
Maximum weighing	120g	120g	120g
Resolution (d)	5mg	1mg	0.1mg
Accuracy for moisture	sample<10g	±10%	±0.2%
	sample≥10g	±5%	±0.1%
Operation temperature	13~25°C		
Verification interval	2.5s		
Warm-up time	20~30 minutes		
Weighing pan size	Ø90mm		
Heating source	halogen lamp (450W)		
Range for heating temperature	60~200°C		
Heating time setting	0~99 minutes		
Heating mode	standard heating, step heating, rapid heating		
Shutdown mode	automatic shutdown, manual shutdown, timed shutdown		
Output	RS232C		
Power supply	220V, 50/60Hz		
Dimension (L×W×H)	330×210×340mm		

STANDARD DELIEVERY

Main unit	1 pc
Weight	1 pc

OPTIONAL ACCESSORY

RS232 cable	8304-CABLE *
Printer	8303-PRINTER

*Used to connect with computers



WEIGHTS



1kg 200g 500mg 200mg 100mg

- Supplied with manufacturer inspection certificate

OIML R111-2004 TOLERANCE

Weight	E2	F1	F2	M1
1mg	0.006mg	0.020mg	0.06mg	0.20mg
2mg	0.006mg	0.020mg	0.06mg	0.20mg
5mg	0.006mg	0.020mg	0.06mg	0.20mg
10mg	0.008mg	0.025mg	0.08mg	0.25mg
20mg	0.010mg	0.03mg	0.10mg	0.3mg
50mg	0.012mg	0.04mg	0.12mg	0.4mg
100mg	0.016mg	0.05mg	0.16mg	0.5mg
200mg	0.020mg	0.06mg	0.20mg	0.6mg
500mg	0.025mg	0.08mg	0.25mg	0.8mg
1g	0.03mg	0.10mg	0.3mg	1.0mg
2g	0.04mg	0.12mg	0.4mg	1.2mg
5g	0.05mg	0.16mg	0.5mg	1.6mg
10g	0.06mg	0.20mg	0.6mg	2.0mg
20g	0.08mg	0.25mg	0.8mg	2.5mg
50g	0.10mg	0.3mg	1.0mg	3.0mg
100g	0.16mg	0.5mg	1.6mg	5.0mg
200g	0.3mg	1.0mg	3.0mg	10mg
500g	0.8mg	2.5mg	8.0mg	25mg
1kg	1.6mg	5.0mg	16mg	50mg
2kg	3.0mg	10mg	30mg	100mg
5kg	8.0mg	25mg	80mg	250mg
10kg	16mg	50mg	160mg	500mg
20kg	30mg	100mg	300mg	1000mg

CLASS SELECTION

Resolution of the weighing instruments	Required class of weights
0.001mg	E1
0.01mg	E2
0.1mg	E2/F1
1mg	F2
0.01g/0.1g	M1

Weight	Class and material						Shape	
	E2 (non-magnetic stainless steel)	F1 (non-magnetic stainless steel)	F1 (304 stainless steel)	F2 (304 stainless steel)	M1 (304 stainless steel)	M1 (steel, chrome plated)		
1mg	8911-1MGE2	8911-1MGF1	8911-1MGF1S	8911-1MGF2	8911-1MGM1	—	sheet	
2mg	8911-2MGE2	8911-2MGF1	8911-2MGF1S	8911-2MGF2	8911-2MGM1			
5mg	8911-5MGE2	8911-5MGF1	8911-5MGF1S	8911-5MGF2	8911-5MGM1			
10mg	8911-10MGE2	8911-10MGF1	8911-10MGF1S	8911-10MGF2	8911-10MGM1			
20mg	8911-20MGE2	8911-20MGF1	8911-20MGF1S	8911-20MGF2	8911-20MGM1			
50mg	8911-50MGE2	8911-50MGF1	8911-50MGF1S	8911-50MGF2	8911-50MGM1			
100mg	8911-100MGE2	8911-100MGF1	8911-100MGF1S	8911-100MGF2	8911-100MGM1			
200mg	8911-200MGE2	8911-200MGF1	8911-200MGF1S	8911-200MGF2	8911-200MGM1			
500mg	8911-500MGE2	8911-500MGF1	8911-500MGF1S	8911-500MGF2	8911-500MGM1			
1g	8911-1GE2	8911-1GF1	8911-1GF1S	8911-1GF2	8911-1GM1	—	cylinder	
2g	8911-2GE2	8911-2GF1	8911-2GF1S	8911-2GF2	8911-2GM1			
5g	8911-5GE2	8911-5GF1	8911-5GF1S	8911-5GF2	8911-5GM1			
10g	8911-10GE2	8911-10GF1	8911-10GF1S	8911-10GF2	8911-10GM1			8911-10GM1C
20g	8911-20GE2	8911-20GF1	8911-20GF1S	8911-20GF2	8911-20GM1			8911-20GM1C
50g	8911-50GE2	8911-50GF1	8911-50GF1S	8911-50GF2	8911-50GM1			8911-50GM1C
100g	8911-100GE2	8911-100GF1	8911-100GF1S	8911-100GF2	8911-100GM1			8911-100GM1C
200g	8911-200GE2	8911-200GF1	8911-200GF1S	8911-200GF2	8911-200GM1			8911-200GM1C
500g	8911-500GE2	8911-500GF1	8911-500GF1S	8911-500GF2	8911-500GM1			8911-500GM1C
1kg	8911-1KGE2	8911-1KGF1	8911-1KGF1S	8911-1KGF2	8911-1KGM1			8911-1KGM1C
2kg	8911-2KGE2	8911-2KGF1	8911-2KGF1S	8911-2KGF2	8911-2KGM1			8911-2KGM1C
5kg	8911-5KGE2	8911-5KGF1	8911-5KGF1S	8911-5KGF2	8911-5KGM1			8911-5KGM1C
10kg	8911-10KGE2	8911-10KGF1	8911-10KGF1S	8911-10KGF2	8911-10KGM1	8911-10KGM1C		
20kg	8911-20KGE2	8911-20KGF1	8911-20KGF1S	8911-20KGF2	8911-20KGM1	8911-20KGM1C		

WEIGHT SETS



- Supplied with manufacturer inspection certificate



8910-200GF1

CLASS AND MATERIAL

Specification	Code				
	E2 (non-magnetic stainless steel)	F1 (non-magnetic stainless steel)	F1 (304 stainless steel)	F2 (304 stainless steel)	M1 (304 stainless steel)
1mg~100g	8910-100GE2	8910-100GF1	8910-100GF1S	8910-100GF2	8910-100GM1
1mg~200g	8910-200GE2	8910-200GF1	8910-200GF1S	8910-200GF2	8910-200GM1
1mg~1kg	8910-1KGE2	8910-1KGF1	8910-1KGF1S	8910-1KGF2	8910-1KGM1
1mg~2kg	8910-2KGE2	8910-2KGF1	8910-2KGF1S	8910-2KGF2	8910-2KGM1
1mg~5kg	8910-5KGE2	8910-5KGF1	8910-5KGF1S	8910-5KGF2	8910-5KGM1

SPECIFICATION AND SHAPE

Weight	Specification				
	1mg~100g	1mg~200g	1mg~1kg	1mg~2kg	1mg~5kg
1mg	◆	◆	◆	◆	◆
2mg	◆◆*	◆◆*	◆◆*	◆◆*	◆◆*
5mg	◆	◆	◆	◆	◆
10mg	◆	◆	◆	◆	◆
20mg	◆◆*	◆◆*	◆◆*	◆◆*	◆◆*
50mg	◆	◆	◆	◆	◆
100mg	◆	◆	◆	◆	◆
200mg	◆◆*	◆◆*	◆◆*	◆◆*	◆◆*
500mg	◆	◆	◆	◆	◆
1g	■	■	■	■	■
2g	■◆*	■◆*	■◆*	■◆*	■◆*
5g	■	■	■	■	■
10g	■	■	■	■	■
20g	■◆*	■◆*	■◆*	■◆*	■◆*
50g	■	■	■	■	■
100g	■	■	■	■	■
200g		■◆*	■◆*	■◆*	■◆*
500g			■	■	■
1kg			■	■	■
2kg				■◆*	■◆*
5kg					■
Quantity	21 pcs	23 pcs	25 pcs	27 pcs	28 pcs
Total range	1mg~211.11g	1mg~611.11g	1mg~2111.11g	1mg~6111.11g	1mg~11111.11g

- ◆ sheet
- cylinder
- ◆* sheet, with mark
- * cylinder, with mark



Salt Spray Testers
Page 820



Temperature And Humidity Testers
Page 821-822

SALT SPRAY TESTER CODE SFT-S210R



- Using plastic precision nozzle and conical spray device, the salt spray drops evenly and rapidly, the nozzle has a long working life and does not crystallize
- The spraying time can be controlled internally without external time relay
- The flow rate of salt water and the pressure of compressed air are regulated by flow meter and pressure regulating valve to ensure uniform salt spray settlement
- Manual water adding system can automatically replenish when the water level is insufficient to ensure uninterrupted test

SPECIFICATION

Test condition	suitable for neutral and acid salt spray test
Working chamber dimension (WxHxD)	900x500x600mm
Working chamber volume	270L
Saline tank volume	25L
Working chamber temperature	35±1°C
Saturated barrel temperature	47±1°C
Saline temperature	35±1°C
Heating mode	heat radiation
Spray mode	continuous, intermittent
Test fluid	neutral: purified water+sodium chloride (PH6.5~7.2)
Compressed air pressure	2~3kgf/cm ²
Power supply	AC 220V, 1Ø, 50HZ, 2kW
Dimension (WxHxD)	1560x1250x910mm
Weight	118kg

STANDARD DELIVERY

Main unit	1 pc
Stick	1 group
Sodium chloride	2 bottles
10L salt water preparation measuring cup	1 pc
80ml standard cup	2 pcs
50ml metering cup	2 pcs

OPTIONAL DELIVERY

Nozzle	SFT-S210R-NOZZLE
Brine Filter	SFT-S210R-FILTER



TABLE TYPE TEMPERATURE AND HUMIDITY TESTER CODE THT-Z158



- Table design, quiet and small
- Equipped with operation system with 7-inch touch screen controller
- Intelligent refrigeration and dehumidification system, it can save 30~45% of electricity compared with traditional machines
- Output excel data report through USB port

SPECIFICATION

Working chamber dimension (WxHxD)		300x350x300mm
Working chamber volume		32L
Temperature range		-40~120°C
Humidity range		20~98%RH
Temperature/humidity fluctuation		≤2°C, ±3%RH
Temperature/humidity uniformity		±0.5°C, ±2.5%RH
Temperature/humidity stability		±0.3°C, 2.5%RH
Warming up time		1~3°C/min
Cooling time		0.7~1°C/min
Operation environment	environment temperature	5~35°C
	relative humidity	≤85%RH
Material	case material	cold rolled steel plate+varnish
	working chamber material	SUS#304 stainless steel
	thermal insulation material	polyurethane foam
Freezing system		compressor
Protector		compressor overload protection switch, refrigerant high pressure protection switch, ceramic fuse, water plate of water shortage protection switch, electromagnetic switch, air burn protection switch, alarm
Power supply		AC220, 50/60HZ, 2kW
Dimension (WxHxD)		550x850x1050mm
Weight		185kg

STANDARD DELIVERY

Main unit	1 pc
Test hole	1 pc
Shelf	2 pcs

TEMPERATURE AND HUMIDITY TESTERS



THT-A101T

- The tester is equipped with an independent operation system with 7-inch touch screen controller
- Intelligent refrigeration and dehumidification system, combined with energy-saving control algorithm, can adjust the refrigeration level and save energy. Compared with traditional machines, it can save 30~45% of electricity
- It can output excel data report through USB port

SPECIFICATION

Code	THT-A101T	THT-A102T	THT-A103T	THT-A104T	THT-A105T
Working chamber dimension (WxHxD)	500x600x500mm	500x500x400mm	500x750x600mm	700x850x700mm	1000x1000x1000mm
Working chamber volume	150L	100L	225L	416L	1000L
Temperature range	-40~150°C				
Humidity range	10~98%RH				
Temperature/humidity fluctuation	±0.5°C, ±2.5%RH				
Temperature/humidity uniformity	<2°C, 5%RH				
Temperature/humidity stability	0.2°C, 2%RH				
Temperature/humidity deviation	±2°C, 3%RH				
Warming up time	about 3°C/min				
Cooling time	about 1°C/min				
Material	case material	cold rolled steel plate+varnish			
	working chamber material	SUS#304 stainless steel			
	thermal insulation material	rigid polyurethane foam			
Freezing system	compressor				
Protector	no fuse switch, compressor overpressure, overheat protection, overtemperature protection, overload protection, dry burning protection, water shortage protection, etc				
Power supply	AC220V, 50HZ, 4.5kW	AC220V, 50HZ, 2kW	AC380V, 3Ø, 50HZ, 4kW	AC380V, 3Ø, 50HZ, 3.5kW	AC380V, 3Ø, 50HZ, 3.5kW
Dimension (WxHxD)	800x1660 x1400mm	750x1550 x1170mm	850x1750 x1200mm	950x1850 x1400mm	1300x1950 x1850mm
Weight	365kg	285kg	385kg	510kg	950kg

STANDARD DELIVERY

Main unit	1 pc
Test hole	1 pc
Shelf	2 pcs



CODE	PAGE
00	
0010.....	654
0020.....	640
0021.....	641
01	
0110.....	653
0120.....	651
0130.....	656
0131.....	655
0132.....	656-657
0140.....	652
02	
0210.....	662
0213.....	663
0215.....	663
03	
0310.....	666
0311.....	664
0312.....	628
0313.....	665
0314.....	667
0320.....	666
04	
0411.....	647
0431.....	648
05	
0501.....	659
06	
0611.....	657
0612.....	658
11	
1102.....	20
1103.....	20
1106.....	33
1108.....	21
1109.....	22
1110.....	24
1111.....	25
1113.....	19
1114.....	21
1115.....	20
1117.....	34
1118.....	19
1119.....	22
1120.....	45
1121.....	44
1122.....	56
1123.....	53
1124.....	41
1125.....	38-39
1128.....	48
1129.....	47
1130.....	23
1135.....	35
1136.....	34

CODE	PAGE
1138.....	54
1139.....	26
1140.....	73
1141.....	66
1142.....	67
1143.....	70
1144.....	68
1145.....	73
1146.....	264
1147.....	67
1148.....	69
1149.....	66
1150.....	84
1151.....	86
1154.....	87
1155.....	81
1156.....	85
1157.....	82
1158.....	83
1160.....	373
1161.....	58
1162.....	63
1163.....	263
1165.....	60
1166.....	393
1167.....	63
1168.....	64
1169.....	51
1170.....	25
1171.....	25
1172.....	60
1173.....	32
1176.....	46
1177.....	55
1178.....	48
1179.....	58
1180.....	194
1181.....	62
1183.....	52
1184.....	57
1185.....	50
1186.....	57
1187.....	50
1188.....	52
1189.....	191
1191.....	49
1192.....	54
1193.....	23
1196.....	21
1199.....	47
12	
1201.....	26
1202.....	27
1203.....	26
1204.....	26
1205.....	27
1207.....	35
1208.....	36
1210.....	36
1214.....	37
1215.....	37
1217.....	28

CODE	PAGE
1223.....	28
1224.....	29
1226.....	29
1229.....	62
1233.....	27
1236.....	35
1238.....	28
1239.....	29
1240.....	70
1243.....	72
1244.....	72
1247.....	71
1248.....	71
1249.....	71
1250.....	87
1251.....	88
1253.....	87
1262.....	46
1267.....	194
1273.....	61
1275.....	392
1281.....	62
1291.....	49
13	
1311.....	26
1312.....	26
1340.....	70
1351.....	86
15	
1501.....	192
1520.....	43
1524.....	55
1525.....	56
1526.....	39-40
1527.....	59
1528.....	59
1530.....	42
1532.....	53
1533.....	60
1534.....	53
1535.....	51
1536.....	61
1537.....	195
1538.....	64
1539.....	61
1540.....	68
21	
2103.....	202
2104.....	202
2108.....	206
2109.....	207
2112.....	200
2114.....	207
2115.....	204
2116.....	201
2117.....	209
2118.....	208
2121.....	248
2122.....	176
2124.....	171

CODE	PAGE
2126.....	175
2127.....	177
2128.....	177
2131.....	252
2132.....	253
2133.....	212
2134.....	211
2137.....	206
2138.....	203
2139.....	203
2140.....	213
2141.....	76
2142.....	74
2143.....	77
2144.....	351
2145.....	77
2146.....	265
2147.....	265
2149.....	210
2151.....	249
2152.....	174
2153.....	174
2163.....	263
2164.....	263
2166.....	262
2167.....	262
2168.....	264
2170.....	445
2171.....	336
2174.....	335
2175.....	444
2176.....	336
2177.....	335
2179.....	444
2182.....	267
2183.....	190
2184.....	262
2186.....	261
2187.....	305
2188.....	189
2189.....	267
2197.....	191
2198.....	445
2199.....	443
22	
2222.....	248
2223.....	251
2230.....	271
2231.....	272
2232.....	275
2233.....	274
2234.....	269
2235.....	270
2236.....	279
2237.....	277
2240.....	271
2241.....	273
2242.....	275
2243.....	274
2245.....	269
2246.....	278
2247.....	276

CODE	PAGE
2250.....	281
2251.....	280
2260.....	281
2261.....	280
2274.....	391
2275.....	346
2276.....	389
2278.....	390
2280.....	346
2281.....	391
2282.....	392
23	
2301.....	214
2302.....	216
2307.....	218
2308.....	214
2309.....	217
2310.....	216
2311.....	214
2313.....	213
2314.....	215
2316.....	218
2318.....	217
2321.....	249
2322.....	176
2324.....	215
2326.....	218
2328.....	216
2332.....	253
2333.....	252
2334.....	250
2341.....	75
2342.....	75
2343.....	74
2344.....	618
2348.....	179
2361.....	255
2363.....	256
2364.....	254
2365.....	255
2366.....	254
2367.....	259
2372.....	339
2373.....	339
2374.....	338
2380.....	197
2381.....	197
2383.....	197
2385.....	432
2386.....	198
2394.....	439
2395.....	181
2396.....	224
2397.....	439
2398.....	198
2399.....	198
24	
2480.....	199
25	
2501.....	205

CODE	PAGE
2511.....	190
27	
2710.....	257
2711.....	251
2715.....	187
2716.....	188
2724.....	178
2771.....	340
28	
2801.....	215
2824.....	178
2825.....	175
2827.....	177
2828.....	177
2841.....	266
2843.....	618
2844.....	619
2852.....	174
2853.....	174
2859.....	260
2862.....	257
2863.....	257
2866.....	257
2870.....	257
2871.....	254
2872.....	255
2873.....	259
2876.....	259
2877.....	256
2878.....	258
2879.....	256
29	
2931.....	90
31	
3101.....	101
3102.....	103
3108.....	102
3109.....	104
3127.....	168~169
3128.....	170
32	
3202.....	106
3203.....	107
3205.....	113
3206.....	110
3208.....	109
3209.....	109
3210.....	108
3220.....	158
3221.....	159
3222.....	161
3224.....	160
3225.....	162
3226.....	166
3227.....	167~168
3228.....	170
3229.....	160
3230.....	125

CODE	PAGE
3231.....	109
3232.....	129
3233.....	132
3234.....	139
3235.....	113
3236.....	110
3238.....	142
3239.....	138
3240.....	78
3241.....	79
3260.....	135
3261.....	134
3262.....	138
3263.....	147
3264.....	147
3266.....	131
3280.....	141
3281.....	120
3282.....	145
3283.....	143
3285.....	148
3287.....	117
3288.....	137
3290.....	140
3291.....	124
3292.....	147
3293.....	148
3294.....	145
3296.....	116
3297.....	127
33	
3331.....	116
3332.....	114
3334.....	261
3335.....	260
3346.....	114
3350.....	97
3351.....	98
3352.....	130
3353.....	146
3354.....	126
3355.....	136
3356.....	133
3358.....	96
34	
3400.....	108
35	
3506.....	111
3520.....	159
3521.....	163
3530.....	125
3532.....	129
3533.....	132
3534.....	139
3538.....	142
3539.....	138
3540.....	78
3560.....	135
3561.....	134
3562.....	139

CODE	PAGE
3565.....	104
3566.....	131
3580.....	141
3581.....	121
3583.....	143
3588.....	137
3590.....	140
3591.....	124
3594.....	145
3597.....	127
36	
3632.....	99
3634.....	163
3635.....	164
3636.....	122
3638.....	165
3641.....	165
3650.....	128
3653.....	137
3658.....	131
3659.....	125
3661.....	100
3675.....	112
3676.....	144
3677.....	144
3678.....	159
3679.....	158
3680.....	118
3681.....	106
3682.....	105
3683.....	162
3684.....	161
3685.....	115
37	
3701.....	105
40	
4001.....	293
4002.....	297
4004.....	416
4006.....	415
41	
4100.....	287
4101.....	288
4105.....	285
4106.....	286
4107.....	290
4108.....	289
4110.....	300
4111.....	284
4118.....	300
4120.....	317
4121.....	324
4124.....	307
4129.....	318~322
4130.....	313
4131.....	323
4139.....	314~316
4141.....	341
4142.....	411



CODE	PAGE
4143	414
4144	340
4147	349
4155	417
4157	359
4158	418
4160	291
4164	289
4166	299
4168	309
4176	290
4177	331
4178	332-333
4179	79
4180	349
4184	148
4190	308
4191	350
4192	301
4193	298
4194	298
4198	483
42	
4206	181
4208	181
4209	182
46	
4601	363
4602	363
4605	364
4608	364
4621	366
4622	366
4623	365
4624	365
4630	374
4647	325
4649	311
4683	172-173
4662	309
4666	312
4676	310
4677	326-330
47	
4700	348
4701	346
4702	348
4706	348
4707	345
4710	341
4720	357
4721	355
4722	358
4723	356
4725	353
4726	354
4728	359
4731	354
4732	355
4733	358

CODE	PAGE
4745	347
4747	347
4754	348
4760	347
4762	347
4770	342
4771	360
4780	337
4781	337
4782	357
4786	355
4788	356
4789	353
4790	342
4791	343
4792	345
4793	344
4794	343
4795	345
4796	344
4797	338
4799	337
48	
4801	370
4802	370
4803	372
4804	370
4806	369
4807	369
4808	372
4809	372
4810	368
4812	369
4820	367
4824	368
4829	389
4830	375
4831	376
4832	376
4833	374
4834	377
4835	379
4836	376
4837	374
4838	378
4839	381
4840	380
4841	381
4842	371
4843	371
4844	195
4845	619
4846	380
4847	377
4848	377
4849	379
4850	379
4851	380
4852	375
4853	373
4854	371
4855	375

CODE	PAGE
4860	368
4865	266
49	
4902	446
4903	447
4905	447
4906	446
4907	447
4908	447
4910	448
4911	450
4912	448
4913	449
4914	450
4917	452
4918	451
4920	451
4921	449
4922	449
4923	451
50	
5013	399
5021	395
5022	395
5023	396
5024	396
5031	396
5032	396
5041	397
5042	397
5051	397
5052	398
5061	398
5062	398
5063	399
5064	382
5071	382
5072	382
5091	399
51	
5101	563
5102	565
5103	567
5104	564
5106	573
5107	569
5108	566
5109	568
52	
5201	653
53	
5301	532
5302	528
5303	531
5305	575
5307	547
5309	556-557
5310	538-539

CODE	PAGE
5311	558-559
5313	533
5314	429-430
5315	529-530
5316	544
5317	545-546
5318	534
5319	548
57	
5700	624
5701	623-624
5702	620
5704	624
58	
5801	649
5802	649
5803	650
59	
5900	659
61	
6140	29
6141	72
6143	51
6144	31
6145	31
6146	32
62	
6202	236
6207	237
6208	234
6210	234
6211	237
6212	237
6214	238
6215	237
6216	236
6217	238
6219	233
6221	236
6224	235
6225	239
6226	238
6227	239
6228	235
6229	233
6230	239
6250	275
6251	270
6252	273
6254	281
6272	235
6282	219-221
6284	199
6291	232
6293	231
6294	232
6295	232
6296	231

CODE	PAGE
6297.....	231
6298.....	199
63	
6300.....	150
6301.....	150
6302.....	149
6307.....	153
6309.....	30
6310.....	151
6312.....	306
6315.....	149
6316.....	304
6318.....	152
6328.....	297
6329.....	297
6353.....	153
6372.....	154
6373.....	154
6375.....	156
6377.....	156
6381.....	155
6384.....	154
6385.....	154
6386.....	155
6387.....	155
6388.....	156
6391.....	357
65	
6511.....	414
6512.....	412-413
6519.....	421
6520.....	421
6521.....	420
6522.....	419
6523.....	419
6524.....	420
6526.....	421
6527.....	418
6528.....	420
6531.....	415
6533.....	413
6534.....	413
6535.....	416
6536.....	418
6537.....	411
6538.....	419
6539.....	411
6547.....	416
6548.....	417
6549.....	417
6553.....	438
6554.....	438
6555.....	439
6556.....	438
6557.....	438
6558.....	435
6562.....	434
6566.....	433
6567.....	434
6568.....	434
6571.....	432

CODE	PAGE
6572.....	433
6573.....	433
6582.....	422
6583.....	425
6584.....	423
6585.....	424
6586.....	424
6587.....	424
6588.....	425
68	
6801.....	409
6802.....	405
6803.....	405
6804.....	406
6805.....	407
6806.....	406
6832.....	378
6841.....	240
6842.....	244
6843.....	92
6844.....	91
6845.....	245
6846.....	245
6847.....	93
6852.....	351
6862.....	243
6863.....	242
6864.....	242
6865.....	246
6866.....	240
6867.....	241
6869.....	243
6870.....	241
6874.....	295
6875.....	674
6876.....	240
6878.....	410
6879.....	415
6880.....	79
6881.....	292
6882.....	294
6883.....	291
6884.....	296
6885.....	483
6886.....	291
6887.....	407
6888.....	407
6889.....	408
6890.....	409
6891.....	410
6892.....	410
6896.....	404
6897.....	408
6898.....	404
69	
6900.....	402
6902.....	403
6903.....	403
6990.....	394
71	

CODE	PAGE
7101.....	460
7102.....	460
7106.....	229
7107-1.....	230
7107-11.....	228
7107-11V.....	228
7107-12.....	228
7107-12V.....	228
7107-2.....	230
7107-3.....	230
7110.....	388
7111.....	350
7113.....	387
7114.....	183
7117.....	349
7118.....	350
7119.....	388
7120.....	392
7123.....	389
7130.....	225-226
7131.....	225
7134.....	227-228
7135.....	182
7136.....	183
7139.....	386
7140.....	384
7142.....	385
7143.....	386
7144.....	386
7145.....	387
7146.....	387
7150.....	88
7160.....	594
7161.....	595
7162.....	594
7163.....	595
7164.....	595
72	
7202.....	393
7203.....	393
7205.....	392
7210.....	14-15
7230.....	394
7231.....	394
7232.....	394
7240.....	383
7241.....	383
7247.....	384
7260.....	384
7261.....	383
7262.....	383
73	
7302.....	12-13
7304.....	17
7305.....	8-11
7315.....	4-7
7317.....	2-3
7321.....	166
7324-HUB4.....	16
7324-HUB7.....	16
7325.....	17

CODE	PAGE
7327.....	17
7330.....	223
7331.....	222
7332.....	222
7333.....	222
7338.....	395
7340.....	301
7341.....	302
7342.....	301
7344.....	303
7350.....	180
7351.....	179
7353.....	180
7360.....	209
7381.....	122
7382.....	117
7383.....	123
7384.....	119
7385.....	166
7386.....	151
7390.....	119
7391.....	124
7393.....	123
7394.....	118
75	
7511.....	590
7512.....	593
7513.....	592
7514.....	590
7515.....	590
7516.....	587
7517.....	587
7518.....	593
7520.....	587
7521.....	587
7522.....	592
7523.....	594
7524.....	590
7525.....	588
7526.....	589
7527.....	591
7528.....	591
7529.....	592
7530.....	593
76	
7600.....	650
80	
8001.....	808
8002.....	808
8003.....	810
81	
8101.....	809
8105.....	807
82	
8201.....	813
8202.....	813
8203.....	815
8204.....	814-815



CODE	PAGE
83	
8301.....	807
8303.....	805
8304.....	804
8305.....	806
8310.....	803
84	
8401.....	812
85	
8501.....	811
86	
8601.....	809
8602.....	810
87	
8701.....	816
89	
8910.....	818
8911.....	817
91	
9130.....	662
9132.....	661
92	
9216.....	642
9223.....	638
9224.....	639
9225.....	639
9241.....	641
9242.....	643
9246.....	644
9247.....	643
93	
9315.....	645
9341.....	651
9351.....	655
9353.....	654
9362.....	665
94	
9401.....	461
9408.....	461
9410.....	431
9411.....	437
9412.....	436
9413.....	427~428
95	
9501.....	615
9503.....	617
9561.....	647
9563.....	385
96	
9631.....	714
9643.....	746

CODE	PAGE
97	
9710.....	622
9720.....	641
9721.....	646
9722.....	646
9723.....	646
CMM	
CMM-MN432.....	475~476
CMM-ST□□□.....	477~479
CMM-CM□□□.....	479~480
CMM-BE□□□.....	479~480
CST	
CST-D101.....	749
CST-D102.....	749
DBC	
DBC-M660.....	628
DSW	
DSW-A010.....	650
GRL	
GRL-L340.....	453
HDT	
HDT-A410.....	700~701
HDT-A510.....	700~701
HDT-A610.....	700~701
HDT-B-□□□.....	747~748
HDT-B430.....	736
HDT-BRV130.....	726
HDT-CB320.....	728~729
HDT-L410.....	735
HDT-L411.....	737
HDT-LP200.....	733
HDT-LP200B.....	733
HDT-MV280.....	717
HDT-MV280S.....	717
HDT-MV290.....	716
HDT-MV290S.....	716
HDT-MVH1100.....	715
HDT-PB350.....	741
HDT-RA151.....	709
HDT-RSR100.....	712
HDT-RT151.....	704~705
HDT-RT152.....	704~705
HDT-RT153.....	704~705
HDT-RW160.....	711
HDT-VD□□□.....	720
HDT-VS1D.....	718~719
HDT-VS530.....	721
HDT-WL320.....	728~729
HDT-WP201.....	734
HDT-XB500.....	722
HSM	
HSM-A310.....	468
ISD	
ISD-CL□□□.....	524

CODE	PAGE
ISD-E320.....	513~514
ISD-E430.....	513~514
ISD-H210.....	511
ISD-H320.....	511
ISD-H430.....	511
ISD-V150A.....	512~513
ISD-V220□□□.....	515~516
ISD-V250A.....	512~513
ISD-V270□□□.....	515~516
ISD-V300A.....	512~513
ISD-V370□□□.....	515~516
ISD-V400A.....	512~513
ISD-V500HN.....	517~518
ISD-V500N.....	517~518
ISD-VMM□□□.....	526~527
ISE	
ISE-2DT.....	442
ISE-L051.....	441
ISE-L051L.....	441
ISF	
ISF-1DF□□□.....	773
ISF-DF□□□.....	772
ISF-F□□□.....	774
ISF-H20A.....	776
ISF-H20D.....	776
ISF-MT1K.....	773
ISF-MT500.....	774
ISF-P30A.....	777
ISF-P30D.....	777
ISF-RH62.....	775
ISF-RV61.....	775
ISF-S□□□.....	771
ISF-TG□□□.....	777
ISF-V10A.....	776
ISF-V10D.....	776
ISGF	
ISGF-0501.....	394
ISGF-090.....	394
ISH	
ISH-BRV.....	727
ISH-DSA.....	743
ISH-DSD.....	743
ISH-DSOO.....	743
ISH-DS-STANDA.....	744
ISH-MR150.....	708
ISH-MRD200.....	706
ISH-OS2.....	745
ISH-PHB.....	730
ISH-PHB-B.....	731
ISH-PH-SP9.....	738
ISH-R150.....	710
ISH-RD200.....	707
ISH-RSR400.....	702~703
ISH-RSR500.....	702~703
ISH-RSR600.....	702~703
ISH-S30A.....	744
ISH-S30D.....	744
ISH-SAM.....	745
ISH-SDM.....	745

CODE	PAGE
ISH-SPHA.....	732
ISH-STAC.....	746
ISH-STD.....	746
ISH-TDV1000A.....	713
ISHB	
ISHB-B300.....	743
ISHB-C161.....	742
ISHB-D200.....	723
ISHB-D300.....	723
ISHB-H131.....	741
ISHB-M100.....	724
ISHB-MSA.....	725
ISHB-P101.....	740
ISHR	
ISHR-B141.....	739
ISHR-D121.....	738
ISHR-M111.....	739
ISHR-P151.....	740
ISHR-T100.....	698~699
ISHR-T200.....	698~699
ISHR-T300.....	698~699
ISHW	
ISHW-B□□□.....	742
ISHW-L□□□.....	742
ISL	
ISL-A1-□□□.....	455~456
ISL-A5-□□□.....	455~456
ISL-B1-□□□.....	456~457
ISL-B5-□□□.....	455~457
ISL-DR2.....	458
ISL-DR3.....	458
ISL-SET1.....	459
ISM	
ISM-AD-□□□.....	586
ISM-CM20.....	580~581
ISM-CM63.....	578~579
ISM-CT820.....	549
ISM-DL300.....	535~536
ISM-DL301.....	535~536
ISM-DL302.....	537
ISM-DL400.....	551~552
ISM-DL510.....	542~543
ISM-DL520.....	540~541
ISM-DL-COAXIAL.....	554
ISM-DL-LED.....	554
ISM-DL-OB□□□.....	555
ISM-DL-STAGE1.....	553
ISM-LED-100L4.....	553
ISM-LED-9245R.....	553
ISM-LED-BRACKET.....	554
ISM-LED-CTRL.....	553
ISM-MAS100.....	584~585
ISM-MP8B.....	582~583
ISM-MV10.....	579
ISM-PM□□□.....	586
ISM-PM200SA.....	560
ISM-PM200SB.....	560
ISM-POL1000.....	576

CODE	PAGE
ISM-WF200.....	561~562
ISM-ZS100.....	571
ISM-ZS100T.....	571
ISM-ZS200.....	570
ISM-ZS30.....	574
ISM-ZS50.....	572
ISM-ZS50T.....	572
ISM-ZS70-S.....	577
ISM-ZS-LED.....	554
ISO	
ISO-1000FN.....	617
ISO-1200FN.....	616
ISO-8000FN.....	614
ISP	
ISP-A1000E.....	495~496
ISP-A3000E.....	499~500
ISP-A5000E.....	497~498
ISP-A6000.....	503~504
ISP-A6000E.....	503~504
ISP-A7000E.....	501~502
ISP-AZ3020.....	497~498
ISP-W3020.....	499~500
ISP-W4025.....	501~502
ISP-Z3015.....	495~496
ISQ	
ISQ-20-□□□.....	481
ISQ-25-□□□.....	481
ISQ-30-□□□.....	481
ISQ-35-□□□.....	481
ISQ-40-□□□.....	482
ISQ-45-□□□.....	482
ISQ-50-□□□.....	482
ISQ-55-□□□.....	482
ISQ-DG6.....	620
ISQ-DG8.....	621
ISQ-DRM31.....	648
ISQ-PK100.....	625
ISQ-RA600.....	186
ISQ-RM30.....	649
ISQ-TS120K.....	640
ISR	
ISR-C002.....	685~686
ISR-C003.....	693
ISR-C200.....	683~684
ISR-C300.....	687~689
ISR-CS□□□.....	694
ISR-CS017.....	694
ISR-CS018.....	694
ISR-CS130-W.....	693
ISR-LS□□□.....	695
ISR-RS□□□.....	695
ISR-T120.....	690~692
IST	
IST-04TT□□□.....	780
IST-06TS1100.....	782
IST-06TS2000.....	782
IST-06TS350.....	782
IST-11WM□□□.....	792~793

CODE	PAGE
IST-13W□□□.....	790
IST-15W□□□.....	791
IST-19WM□□□.....	796
IST-25WM□□□.....	795~796
IST-2W□□□.....	787~788
IST-3SD200.....	783
IST-3SD400.....	783
IST-3SD50.....	783
IST-4W□□□.....	789
IST-5W□□□.....	798
IST-9WM□□□.....	794
IST-DCT□□□.....	779
IST-DS□□□.....	784
IST-DT□□□.....	801
IST-DTT1.....	779
IST-DTT10.....	779
IST-DTT5.....	779
IST-DW□□□.....	797
IST-MG□□□.....	784
IST-PW□□□.....	797
IST-SD200.....	782
IST-SD400.....	782
IST-SD50.....	782
IST-ST□□□.....	800~801
IST-TM□□□.....	799
IST-TT□□□.....	781
IST-W□□□.....	786
IST-WP6.....	785
IST-WS□□□.....	785
ISU	
ISU-100D.....	637
ISU-250C.....	636
ISU-300D.....	635
ISU-700D.....	634
ISU-710D.....	633
ISU-720D.....	632
ISU-800D.....	631
ISU-PB3.....	473
ISU-PB5.....	473
ISU-S□□□.....	638
ISV	
ISV-1H□□□.....	611
ISV-1HLED.....	612
ISV-1LED1.....	612
ISV-2CAM.....	612
ISV-E30.....	607
ISV-E40.....	606
ISV-K□□□.....	603
ISV-L.....	599~601
ISV-P6.....	604
ISV-S.....	602
ISV-S106.....	605
ISV-T105.....	605
ISV-VP280.....	610
ISV-Y.....	597~598
ISY	
ISY-100.....	488~489
ISY-200.....	484
ISY-300.....	486
ISY-400.....	487

CODE	PAGE
ISY-500.....	485
ISY-600.....	490
ISY-700.....	523
ITM	
ITM-S300J.....	770
LDM	
LDM-030.....	462
LDM-065.....	462
LDM-D090.....	463
MLP	
MLP-10□□□.....	761
MLP-20□□□.....	761
MLP-30□□□.....	761
MLP-40□□□.....	761
MLP-50□□□.....	761
MLP-60□□□.....	761
MLP-CM1.....	763
MLP-CM2.....	763
MLP-CM3.....	763
MLP-CM4.....	763
MLP-CM5.....	763
MLP-CM6.....	763
MLP-CM60.....	752
MLP-CM86.....	753
MLP-DL□□□.....	764
MLP-DQ□□□.....	761
MLP-DR□□□.....	762
MLP-GP260.....	755
MLP-GP270.....	756
MLP-GP280.....	756
MLP-GP305.....	754
MLP-GP314.....	757
MLP-HCM102.....	751
MLP-MP25.....	760
MLP-MP30.....	759
MLP-MP43.....	758
MLP-MP53.....	758
MLP-MP62.....	759
MLP-OL□□□.....	762
MLP-QM□□□.....	763
MLP-QP1.....	764
MLP-QP2.....	764
MLP-RA.....	764
MPI	
MPI-HF360.....	473
MPI-P110.....	472
OES	
OES-T350.....	464~465
PHT	
PHT-C751.....	625
PPF	
PPF-BF62.....	627
QMS	
QMS-A110.....	509~510
QMS-A200.....	509~510

CODE	PAGE
QMS-A220.....	507~508
QMS-A315.....	507~508
QMS-A320.....	507~508
QMS-A450.....	505~506
QMY	
QMY-AP32.....	627
RCT	
RCT-300.....	670~671
RCT-RA260.....	672~673
SFT	
SFT-S210R.....	820
SPM	
SPM-1000.....	675~676
SPM-2000.....	677~678
SPM-4000.....	681~682
SPM-5000.....	679~680
SPT	
SPT-AD21.....	626
THD	
THD-PF34.....	628
THT	
THT-A□□□.....	822
THT-Z158.....	821
TLP	
TLP-300H.....	494
TLP-400E.....	493
TLP-P340.....	492
UFD	
UFD-T680.....	470~471
UTM	
UTM-E□□□.....	766
UTM-EX□□□.....	769
UTM-H□□□.....	768~769
UTM-S□□□.....	767
VMM	
VMM-L□□□.....	519~520
VSP	
VSP-201.....	608~609
XRF	
XRF-B210.....	466~467

APPLICATION INDEX OF MEASURING TOOLS

SHAFT DIAMETER



Dial Snap Gages
2186-
(page 261)



Adjustable Snap Gages
2187- (page 305)



Indicating Micrometers
3332- (page 114)



Micrometers With Dial Indicator
3296-, 3331-, 3346-
(page 114-116)



Dial Snap Gages
3335-, 3334-
(page 260-261)



Outside Micrometers
(page 101-113)



Universal Calipers
1125-
(page 38-39)



Digital/Dial/Vernier Calipers
(page 19-37)



External Caliper Gages
2131-, 2333-, 2332-, 2132-
(page 252-253)



Circumference Tapes
(page 183)



Internal And External Diameter Comparison Instruments
6844-, 6843-
(page 91-92)



EXTERNAL GROOVE DIAMETER



Digital Blade Calipers
1188-, 1532-
(page 52-53)



Blade Micrometers
3232-, 3532-, 3650-
(page 128-129)



High Precision Digital Blade Micrometers/Snap Gages
3352-
(page 130)



Digital Outside Neck Calipers
1187-
(page 50)



Digital Calipers With Interchangeable Points
1526-, 1124-, 1530-
(page 39-42)



Universal Calipers
1125-
(page 38-39)



External Caliper Gages
2131-, 2333-, 2332-, 2132-
(page 252-253)



Outside Calipers
7262-, 7241-
(page 383)



ARC RADIUS

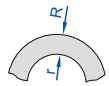

Outside Diameter Variation Measuring Instruments
2715-
(page 187)



Outside Diameter Measuring Instruments
2716-
(page 188)



Digital Radius Gages
2183, 2197, 2511
(page 190-191)

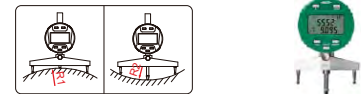

Digital Radius Gages
2188-, 1501-
(page 189)



Digital Arc Radius Calipers
1189-
(page 191)



Radius Gages
4801-, 4804-
(page 370)



APPLICATION INDEX OF MEASURING TOOLS

BORE DIAMETER



Digital/Dial/Vernier Calipers With Internal Measuring Jaws
(page 19-37)



Universal Calipers
1125-
(page 38-39)



Carbon Fiber Comparison Gages
2931-
(page 90)



Digital Inside Knife-edge Calipers
1123-, 1138-
(page 53-54)



Inside Micrometers
3220-, 3520-, 3679-
(page 158-159)



Three Points Internal Micrometers
3227-, 3127-, 3228-, 3128-
(page 167-170)



Pistol Grip Three Points Bore Gages
2124-
(page 171)



Tubular Inside Micrometers
(page 159-164)



Bore Plug Gages
4683-
(page 172-173)



Bore Gages
(page 174-179)



Telescoping Gages
4208-, 4206-, 4209-
(page 181-182)



Inside Calipers
7261-, 7240-
(page 383)



Internal Caliper Gages
(page 248-251)



Taper Bore Gages
4852-, 4855-
(page 375)



Pin Gages
(page 298-301)



Plain Plug Gages
4124- (page 307)



Taper Gages
4833-, 4837-
(page 374)



Internal And External Diameter Comparison Instruments
6844-, 6843-
(page 91-92)



DIAMETER OF GROOVE INSIDE HOLES

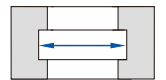

Universal Calipers
1125-
(page 38-39)



Carbon Fiber Comparison Gages
2931-
(page 90)



Digital Calipers With Interchangeable Points
1526-, 1124-, 1530-
(page 39-42)



Inside Groove Calipers
(page 43-49)



Accessory Sets For Digital Calipers
6144, 6145-, 6146-
(page 31-32)



Internal Caliper Gages
(page 248-251)

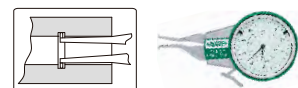

APPLICATION INDEX OF MEASURING TOOLS

WIDTH AND POSITION OF GROOVE INSIDE HOLES

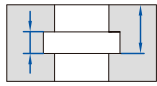

Digital Hook Calipers
1122-
(page 56)



Depth Gages With Hook
1142-, 1144-
(page 67-68)
1540-, 1248-, 1243-
(page 68/71-72)

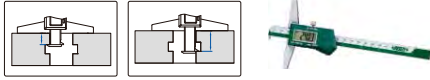

Digital Depth Gages With Round Depth Bar
1148-
(page 69)

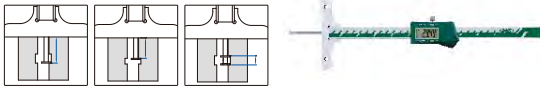

Groove Micrometers
3287- (page 117)

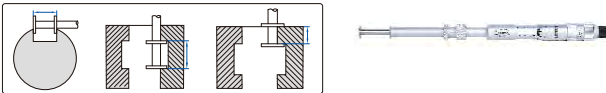

Digital Groove Gages
2145-
(page 77)

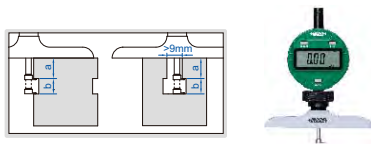

Digital Groove Measurement Stands
6870-
(page 241)



CHAMFER

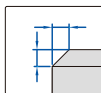

Chamfer Gages
4844-, 1180-, 1267-
(page 194-195)



Digital Chamfer Gages
1537-
(page 195)



TUBE WALL THICKNESS

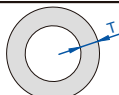

Ultrasonic Thickness Gages
(page 631-637)



Digital Tube Thickness Calipers
1161- (page 58)



Cylindrical Anvil Tube Micrometers
3261-, 3561-
(page 134)



Spherical Anvil Tube Micrometers
3260-, 3560-, 3355-
(page 135-136)



Tube Thickness Gages
2876-, 2367-
(page 259)

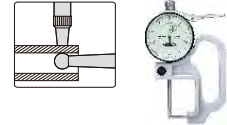

Digital Tube Thickness Gages
2873-
(page 259)

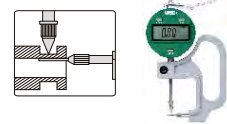

HEIGHT

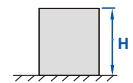

Digital Height Gages
1155-, 1157-, 1158-
(page 81-83)



Height Gages
(page 84-88)



Dial Indicator Stands
(page 240-245)



Transfer Stands
6865-
(page 246)



Mini Digital Height Gages
1146-
(page 264)



APPLICATION INDEX OF MEASURING TOOLS

Digital/Dial Height Gages
2147-, 2146-
(page 265)



Digital Snap Gages
2166-, 2167-, 2163-, 1163-
(page 262-263)



DEPTH



Depth Gages
(page 66)



SHAFT DIAMETER INSIDE HOLE

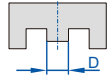

Depth Gages With Point
1143-
(page 70)

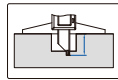

Caliper Type Micrometers
3238-, 3538-
(page 142)



Depth Gages With Hook
1142-, 1144- (page 67-68)
1540-, 1248-, 1243-
(page 68/71-72)

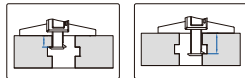

Jaw Type Micrometers
3283-, 3583-
(page 143)



Digital Outside Neck Calipers
1187-
(page 50)



Digital Depth Gages With Round Depth Bar
1148- (page 69)

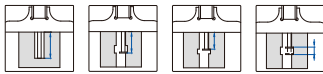

SLOT WIDTH



Mini Depth Gages
1244-, 1145-, 1140-
(page 72-73)



Taper Gages
4833-, 4837-
(page 374)



Dial/Digital Depth Gages
2343-, 2142-, 2341-, 2342-, 2141-
(page 74-77)



Taper Slot Gages
1160-, 4630-
(page 373-374)



Depth Micrometers
3540-, 3240-, 3241-
(page 78-79)



Internal Caliper Gages
(page 248-251)



**Digital/Dial/Vernier Calipers
With Depth Bar**
(page 19-37)



Feeler Gages
4601-, 4602-, 4605-, 4623-
(page 363-365)



THICKNESS



Thickness Gages
(page 254-260)



Step And Gap Gages
2168-
(page 264)

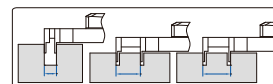

Groove Micrometers
3287-
(page 117)

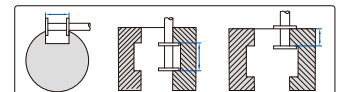

APPLICATION INDEX OF MEASURING TOOLS

HOLE CENTER-TO-CENTER AND CENTER-TO-EDGE DISTANCE

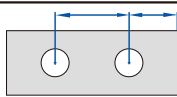

Digital Centering Calipers

1192-, 1177-, 1525-,
1524-
(page 54-56)



Universal Calipers

1125-
(page 38-39)

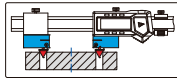

Accessory Sets For Digital Calipers

6144, 6145-, 6146-
(page 31-32)



Straight Edges (page 348-350)



Straightness/Flatness Gages

2144-
(page 351)



Flatness Measurement Stands

6852-
(page 351)



Optical Flats

4191-
(page 350)



ANGLE

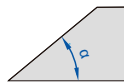

Protractors

(page 335-338)



Digital Angle Meters

2177-
(page 335)



Protractors

2374-, 2372-, 2373-, 2771-
(page 338-340)



Squares

4745-, 4747-, 4760-, 4762-, 4706-, 4754-
(page 347-348)



Angle Gages

4806-, 4807
(page 369)



Angle Gage Blocks

4002-
(page 297)



Digital Levels And Slope Meters

2175-, 2179-, 2170-
(page 444-445)

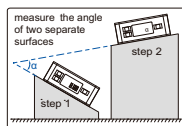

STRAIGHTNESS AND FLATNESS

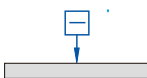

SQUARENESS

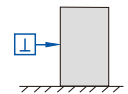

Squares

4141-, 4144-, 4710-
(page 341)



Granite Squares With V Groove

4142-, 6539-
(page 411)



Perpendicularity Testers

4770-
(page 342)



Squares

(page 342-346)



COAXIALITY AND RUNOUT

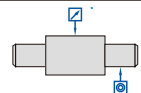

Concentricity Gages

(page 353-355)



Bench Centers

(page 355-359)



V-Blocks

(page 404-408)



APPLICATION INDEX OF MEASURING TOOLS

Magnetic V-Blocks
(page 408-410)



Gear Tooth Pitch Gages
4860-
(page 368)



DIAMETER OF CUTTING TOOLS WITH ODD FLUTES



V Shape Calipers
1229-, 1273-, 1539-
(page 61-62)



V-Anvil Micrometers
3290-, 3590-
(page 140)



KEYWAY



Keyway Depth Gages
2182-, 2189-
(page 267)

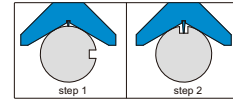

GEAR AND SPLINE



Digital Gear Tooth Calipers
1181-, 1281-
(page 62)

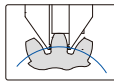

Disk Micrometers
(page 144-146)

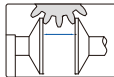

THREAD

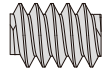

Threaded Hole Location Gages
4662-, 4676-
(page 309-310)



External Gear Tooth Micrometers
3291-, 3591-, 3636-
(page 122-124)

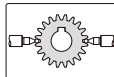

Thread Depth Gages
4649-, 4666-
(page 311-312)



3-Wires
7382-, 7394-
(page 117-118)



Internal Gear Tooth Micrometers
3638-
(page 165)



External Screw Thread Micrometers
3281-, 3581-, 3680-
(page 118/120-121)

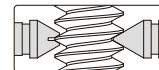

Internal Gear Tooth Micrometers
3678-
(page 159)



Internal Screw Thread Micrometers
3641-, 3226-
(page 165-166)

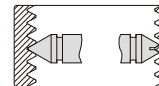

Universal Calipers
1125- (page 38-39)

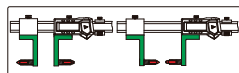

Thread Plug Gages
(page 313-330)



Thread Ring Gages
(page 317-324)



Digital Calipers With Interchangeable Points
1526-, 1124-
(page 39-41)



Pitch Gages
4824-, 4820-
(page 367-368)



APPLICATION INDEX OF MEASURING TOOLS

Universal Calipers

1125-
(page 38-39)



Thread Crest Diameter Measuring Instruments

2237-, 2236-, 2246-, 2247-
(page 276-279)



Digital Calipers With Interchangeable Points

1526-, 1124-
(page 39-41)

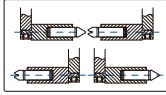

Digital Groove Width Measuring Instrument

2250-, 2260-
(page 281)



FOR OIL PIPES AND FLANGES

Thread Pitch Measuring Instruments

2235-, 2234-, 2245-
(page 269-270)



Digital Groove Diameter Measuring Instrument

2251-, 2261-
(page 280)



Thread Taper Measuring Instruments

2230-, 2231-, 2240-, 2241-
(page 271-273)

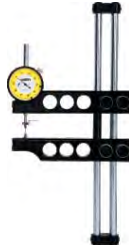

Digital Calipers With Interchangeable Ball Tips

1527-, 1528-
(page 59)



Thread Height Measuring Instruments

2232-, 2233-, 2242-, 2243-
(page 274-275)



Digital RTJ Ring Groove Calipers

1179-
(page 58)



